

RS ITEM NO 211-190

ITEM NO TLW130A

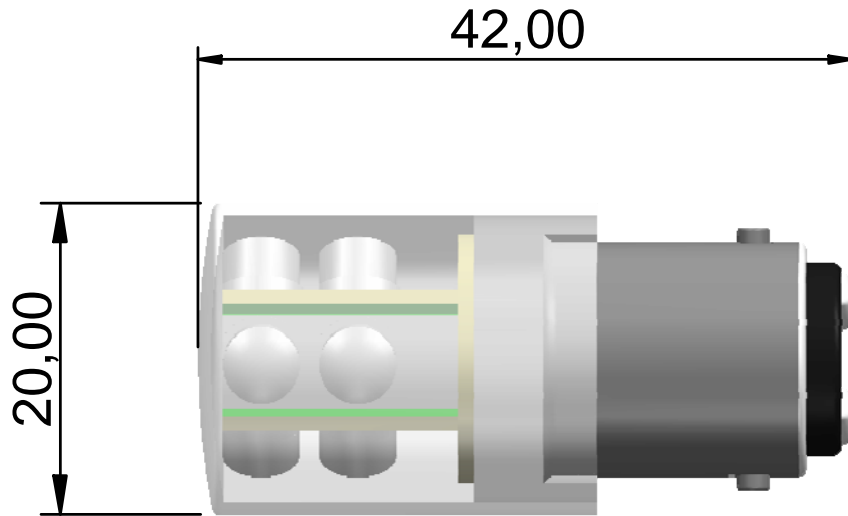

LED/Multiled	<i>LED</i>	Optimum voltage (V)	<i>130Vac</i>	Intensity	<i>130mcd</i>
Mounting Size	<i>13mm</i>	Rectifier		Reverse Voltage	
Mounting Finish		AC current	<i>20mA (max)</i>	360 Illumination for Stack Light or Tower Light	
Protection		DC current			
Mount Holder	<i>BA15D</i>	Voltage Tolerance(%)	<i>10%</i>		
Chip Qty	<i>6</i>	Optimum temperature (°C)	<i>-30°C...+60°C</i>		
Indicator colour	<i>White</i>	Storage temperature (°C)	<i>-30°C...+60°C</i>		
Wavelength (nm)		Contact Tab x 2	<i>BA15D BaseCap</i>		



*Dimension in mm (typical), not to scale.
We reserve the right to make changes without further notice to this product to improve reliability, function or design.*