

RS ITEM NO 207-551

ITEM NO BA9SY6A

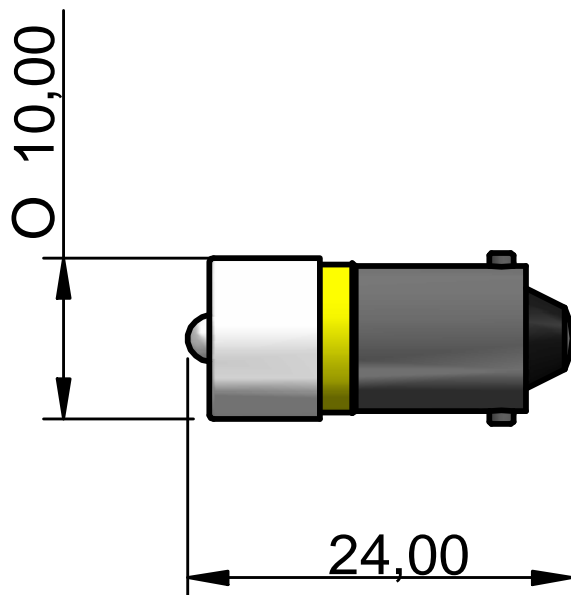

LED/Multiled	<i>LED</i>	Optimum voltage (V)	<i>6Vac/dc</i>	Intensity	<i>630mcd</i>
Mounting Size	<i>10x25mm</i>	Rectifier	<i>Half Wave</i>		
Mounting Finish		AC current	<i>9mA</i>		
Protection		DC current	<i>17mA (max)</i>		
Mount Holder	<i>Ba9s</i>	Voltage Tolerance(%)	<i>10%</i>		
Chip Qty	<i>1</i>	Optimum temperature (°C)	<i>-30°C...+60°C</i>		
Indicator colour	<i>Yellow</i>	Storage temperature (°C)	<i>-30°C...+60°C</i>		
Wavelength (nm)	<i>587</i>	Contact Tab x 2	<i>Ba9s Cap</i>		



*Dimension in mm (typical), not to scale.
We reserve the right to make changes without further notice to this product to improve reliability, function or design.*