

# Datasheet

## RS Pro HSS Counterbores

RS Stock No: 131-842

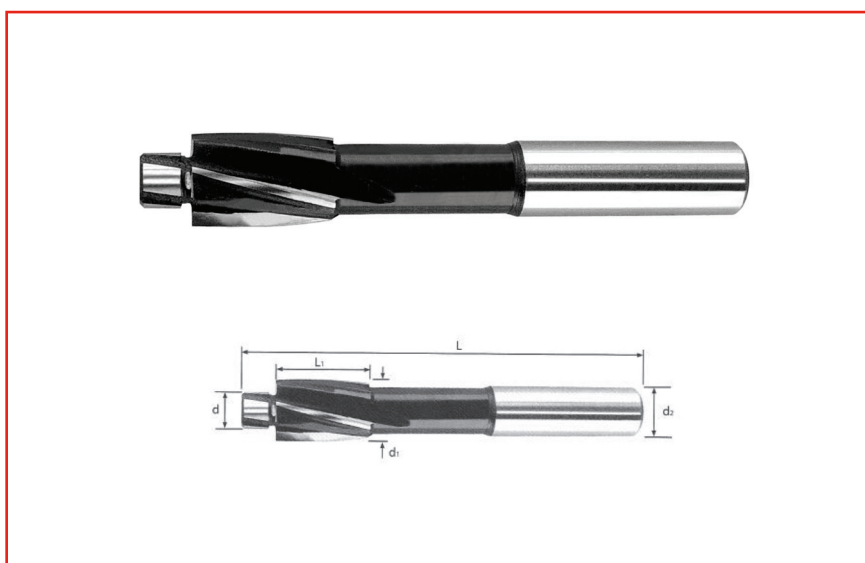

### Specifications:

4 Flute Straight Shank Counterbores

Used to produce recessed holes for cap head screws

Material: High Speed Steel

DIN 373

Screw Size	d1 (mm)	d2 (mm)	d (mm)	L	L1
M5	10	8	6.6	80	18

Order Code	Manufacturers Code	Description
131-842	28-650-005	HSS Counterbore M5