

**Space-saving SOP4-pin
high capacity type
with built-in input resistor**

**PhotoMOS[®]
GU SOP 1 Form A High Capacity
Voltage-sensitive (AQY212FG2S)**

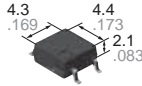

[CAD Data](#)

FEATURES

1. Built-in input resistor means less man-hours when mounting

The voltage-sensitive type, which eliminates the need to mount an external input resistor, is now available in a small package (recommended input voltage is 5 V). Man-hours spent mounting external input resistors are cut and board designing is simplified.

2. Saves space on PC board

Since the small package size remains the same while including a built-in input resistor, space on the PC board is saved. This makes it easier to incorporate space savings when designing miniature devices.

3. Continuous load current of 1.25A

This miniature SOP type controls 1.25A/60V load.

TYPICAL APPLICATIONS

1. Measuring and testing equipment

Semiconductor testing equipment, Probe cards, Datalogger, Board tester and other testing equipment.

2. Telecommunication, Broadcasting, and Medical equipment

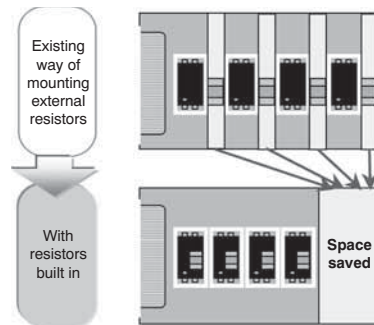

<Artistic impression of PC board space savings due to built-in resistor>

*Above is in case of SSOP.

TYPES

	Output rating*1		Package	Part No.*2			Packing quantity	
	Load voltage	Load current		Tube packing style	Tape and reel packing style		Tube	Tape and reel
					Picked from the 1/2-pin side	Picked from the 3/4-pin side		
AC/DC dual use	60V	1.25A	SOP4-pin	AQY212FG2S	AQY212FG2SX	AQY212FG2SZ	1 tube contains: 100 pcs. 1 batch contains: 2,000 pcs.	1,000 pcs.

Notes:

*1 Indicate the peak AC and DC values.

*2 For space reasons, only "212FG2" is marked on the product. The three initial letters of the part number "AQY", the package (SOP) indicator "S", and the packing style indicator "X" or "Z" have been omitted.

RATING

1. Absolute maximum ratings (Condition: ambient temperature 25°C 77°F)

Item		Symbol	AQY212FG2S	Remarks
Input	Input voltage	V_{IN}	6V	
	Input reverse voltage	V_{RIN}	5V	
	Power dissipation	P_{in}	65mW	*65mW for 1a
Output	Load voltage (peak AC)	V_L	60V	
	Load current	I_L	1.25A	Peak AC, DC
	Peak load current	I_{peak}	3A	100ms (1shot), $V_L=DC$
	Power dissipation	P_{out}	300mW	
Total power dissipation		P_T	350mW	
I/O isolation voltage		V_{iso}	500V AC	
Operating temperature		T_{opr}	-40°C to +85°C -40°F to +185°F	Non-condensing at low temperatures
Storage temperature		T_{stg}	-40°C to +100°C -40°F to +212°F	

GU SOP 1 Form A High Capacity Voltage-sensitive (AQY212FG2S)

2. Electrical characteristics (Condition: ambient temperature 25°C 77°F)

Item		Symbol	AQY212FG2S	Condition		
Input	Operate voltage	Typ.	1.4V	I _L = 100mA		
		Max.	4V			
	Turn off voltage	Min.	0.8V			
		Typ.	1.4V			
Input current	Typ.	I _{IN}	8.5mA	V _{IN} = 5V		
Output	On resistance	Typ.	R _{on}	V _{IN} = 5V, I _L = Max. Within 1 s on time		
		Max.	0.5Ω			
	Output capacitance	Typ.	C _{out}	-	V _{IN} = 0V, V _B = 0V, f = 1MHz	
		Max.	-			
Off state leakage current	Typ.	I _{Leak}	-	V _{IN} = 0V, V _L = Max.		
	Max.	1μA				
Transfer characteristics	Turn on time*	Typ.	T _{on}	V _{IN} = 5V, I _L = 100mA, V _L = 10V		
		Max.	0.7ms			
	Turn off time*	Typ.	T _{off}		0.1ms	
		Max.	0.5ms			
	I/O capacitance	Typ.	C _{iso}		0.8pF	f = 1MHz, V _B = 0V
		Max.	1.5pF		f = 1MHz, V _B = 0V	
Initial I/O isolation resistance	Min.	R _{iso}	1,000MΩ	500V DC		
Maximum operating frequency	Max.	-	5 cps	V _{IN} = 5V, duty = 50% V _I × I _I = 75V·A		

*Turn on/Turn off time

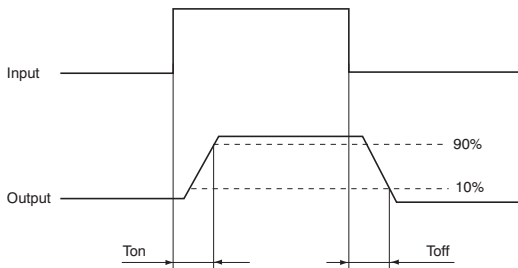

RECOMMENDED OPERATING CONDITIONS

Please obey the following conditions to ensure proper relay operation and resetting.

Item	Symbol	Minimum	Typical	Maximum	Unit
Input voltage	V _{IN}	4.5	5	5.5	V

■ Dimensions

■ Schematic and Wiring Diagrams

■ Cautions for Use

■ These products are not designed for automotive use.

If you are considering to use these products for automotive applications, please contact your local Panasonic technical representative.

Please refer to our information on [PhotoMOS Relays for Automotive Applications](#).

REFERENCE DATA

1. Load current vs. ambient temperature characteristics

Allowable ambient temperature: -40°C to +85°C
-40°F to +185°F

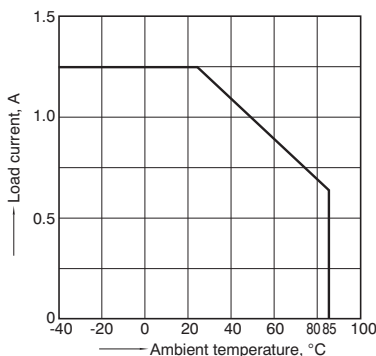

2. On resistance vs. ambient temperature characteristics

Measured portion: between terminals 3 and 4
Input voltage: 5V; Load voltage: Max. (DC);
Continuous load current: Max. (DC)

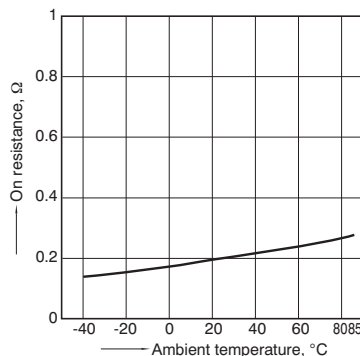

3. Turn on time vs. ambient temperature characteristics

Input voltage: 5V; Load voltage: 10V (DC);
Continuous load current: 100mA (DC)

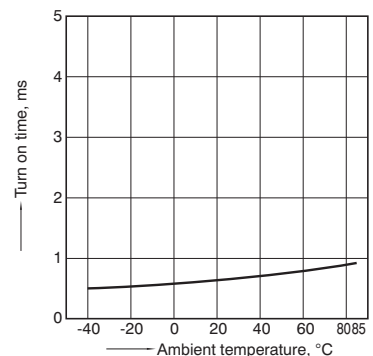

GU SOP 1 Form A High Capacity Voltage-sensitive (AQY212FG2S)

4. Turn off time vs. ambient temperature characteristics

Input voltage: 5V; Load voltage: 10V (DC);
Continuous load current: 100mA (DC)

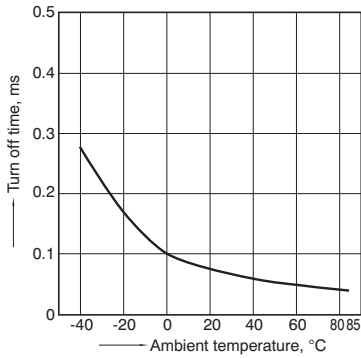

5. Turn on voltage vs. ambient temperature characteristics

Load voltage: 10V (DC);
Continuous load current: 100mA (DC)

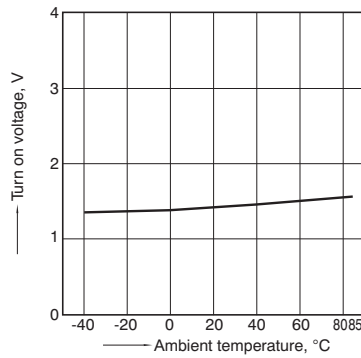

6. Turn off voltage vs. ambient temperature characteristics

Load voltage: 10V (DC);
Continuous load current: 100mA (DC)

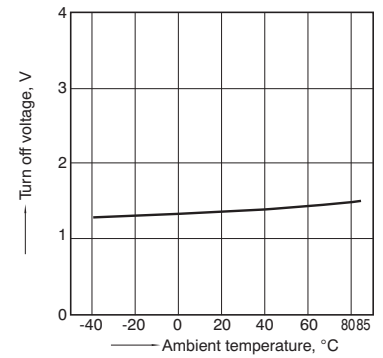

7. Input current vs. ambient temperature characteristics

Input voltage: 5V

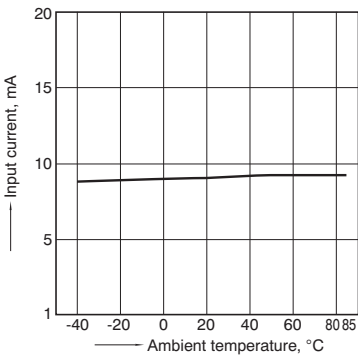

8. Current vs. voltage characteristics of output at MOS portion

Measured portion: between terminals 3 and 4
Ambient temperature: 25°C 77°F

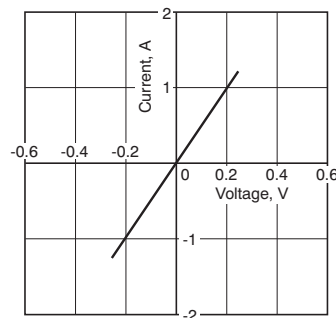

9. Input current vs. input voltage characteristics

Ambient temperature: 25°C 77°F
(Recommended input voltage: 5±0.5V)

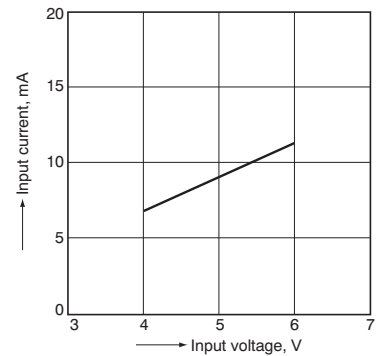

10. Off state leakage current vs. load voltage characteristics

Measured portion: between terminals 3 and 4
Ambient temperature: 25°C 77°F

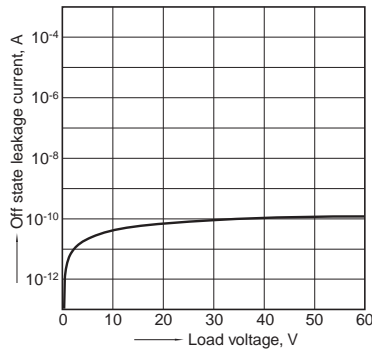

11. Turn on time vs. input voltage characteristics

Measured portion: between terminals 3 and 4
Load voltage: 10V (DC); Continuous load current: 100mA (DC); Ambient temperature: 25°C 77°F

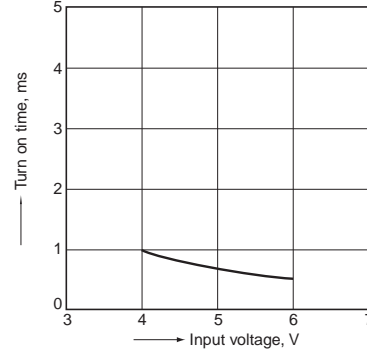

12. Turn off time vs. input voltage characteristics

Measured portion: between terminals 3 and 4
Load voltage: 10V (DC); Continuous load current: 100mA (DC); Ambient temperature: 25°C 77°F

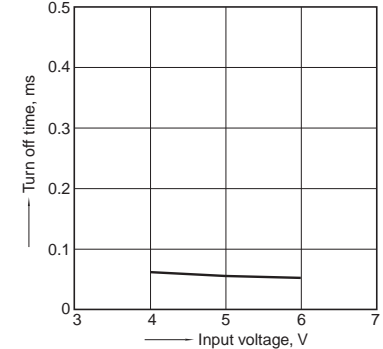

13. Output capacitance vs. applied voltage characteristics

Measured portion: between terminals 3 and 4
Frequency: 1 MHz, 30m Vrms;
Ambient temperature: 25°C 77°F

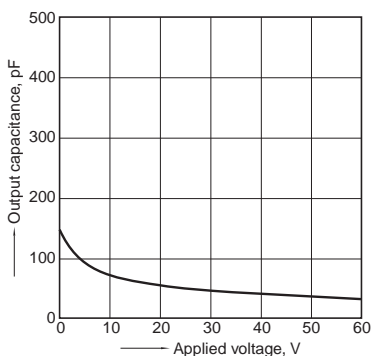

14. Max. operating speed vs. load voltage-load current characteristics

Input voltage: 5V
Ambient temperature: 25°C 77°F

