

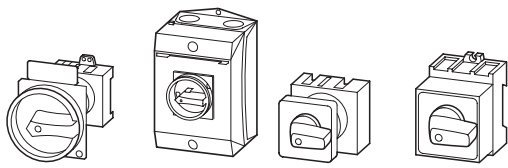

T Rotary Switches, P Switch-Disconnectors

Moeller HPL0211-2004/2005

T rotary switches, P switch-disconnectors



TM mini rotary switches











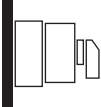

	Page
Technical overview	7/2
System overview	7/4
Key to type references, modular system	7/8
On-Off switches	
Main switches	7/10
On-Off switches	7/16
Safety switches	7/20
Control switches	
Changeover switches	7/22
Reversing switches	7/26
Star-delta switches	7/26
Multi-speed switches	7/28
Step switches	7/30
On-Off switches	7/32
Hand/Auto switches	7/34
On-Off spring-return switches	7/36
Universal control switches	7/38
Coding switches	7/38
Series switches	7/38
Instrument selector switches	7/40
Switches with locking arrangements	
Panic switches	7/42
On-Off switches	7/42
Accessories	
Front plates	7/44
Key operated lock mechanisms	7/46
Other accessories	7/48
Non-standard switches	
T0 rotary switches	7/64
T3 rotary switches	7/65
T5B rotary switches	7/66
T5 rotary switches	7/67
Ordering of non-standard switches	7/69
Tripping characteristics	7/73
Technical data	7/74
Dimensions	7/82

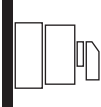
	Page
Technical overview	7/2
System overview	7/54
Key to type references, modular system	7/8
On-Off switches	
Control circuit isolators	7/56
On-Off switches	7/56
Control switches	
Changeover switches	7/57
Step switches	7/58
Hand/Auto switches	7/58
On-Off spring-return switches	7/61
Group switches	7/61
Reversing switches	7/62
Coding switches	7/62
Accessories	
Key operated lock mechanisms	7/63
Non-standard switches	
TM mini rotary switches	7/68
Ordering of non-standard switches	7/69
Technical data	7/81
Dimensions	7/94

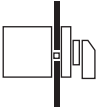

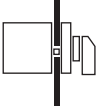
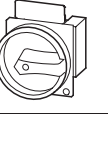
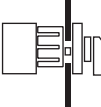
Other standard contact sequences → Catalogue K115

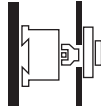
For Immediate Delivery call KMParts.com at (866) 595-9616

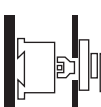
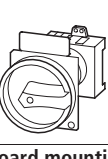
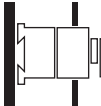
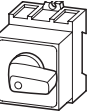
				Switch size				
				TM	T0	T3	T5B	
Three-phase motor ratings	AC--23	220 – 240 V	kW	1.8	3.5	7.5	18.5	
		380 – 440 V	kW	3	6,5	13	22	
Rated operational current	AC--21	380 – 440 V	3~ A	10	20	32	63	
		AC-15	220 – 240 V	A	2.5	6	10	16
			380 – 415 V	A	1.5	4	6	6
Rated uninterrupted current			A	10	20	32	63	
Mounting form								
		Type	Degree of protection					
Surface mounting								
		.../I...	IP65	-	●	●	●	
		.../I 45/...		-	-	-	-	
		.../I 48/...		-	-	-	-	
Surface mounting main switches								
		.../I.../SVB...	IP65	-	●	●	●	
Flush mounting								
		.../E...	Front IP65	●	●	●	●	
Flush mounting main switches/Control circuit isolators								
		.../EA/SVB...	Front IP65	-	●	●	●	
		TM.../E/SVB		●	-	-	-	
Centre mounting								
		.../EZ...	Front IP65	-	●	●	-	
		TM.../EZ		●	-	-	-	
Rear mounting								
		.../Z...	Front IP65	-	●	●	●	
Rear mounting main switches								
		.../V/SVB...	Front IP65	-	●	●	●	
Service distribution board mounting								
		.../VS...	Front IP 30	●	●	-	-	



Moeller HPL0211-2004/2005

T5	T6-3-8212	T6-160-6	T8-3-8342	T8-3-8212	P1		P3		P5			
18,5	37	37	75	75	7	8,5	18,5	30	30	30	37	55
30	45	55	132	132	13	15	37	50	45	55	90	110
100	125	160	315	315	25	32	63	100	125	160	250	315
16	-	-	-	-	-	-	-	-	-	-	-	-
6	-	-	-	-	-	-	-	-	-	-	-	-
100	125	160	315	315	25	32	63	100	125	160	250	315
●	-	-	-	-	●	-	●	-	-	-	-	-
-	-	●	-	-	-	-	-	-	-	-	-	-
-	-	-	● ¹⁾	-	-	-	-	-	-	-	-	-
●	-	-	-	-	●	-	●	-	-	-	-	-
●	●	-	-	●	●	-	●	●	●	●	●	●
●	-	-	-	-	●	-	●	-	●	●	●	●
-	-	-	-	-	-	-	-	-	-	-	-	-
-	-	-	-	-	●	-	-	-	-	-	-	-
●	-	-	-	-	●	-	●	-	-	-	-	-
●	-	●	●	-	●	-	●	●	●	●	●	●
-	-	-	-	-	●	-	●	-	-	-	-	-

Notes

¹⁾ IP64

Rotary Switches, Switch-Disconnectors



On-Off switches: T0, T3, T5B, T5

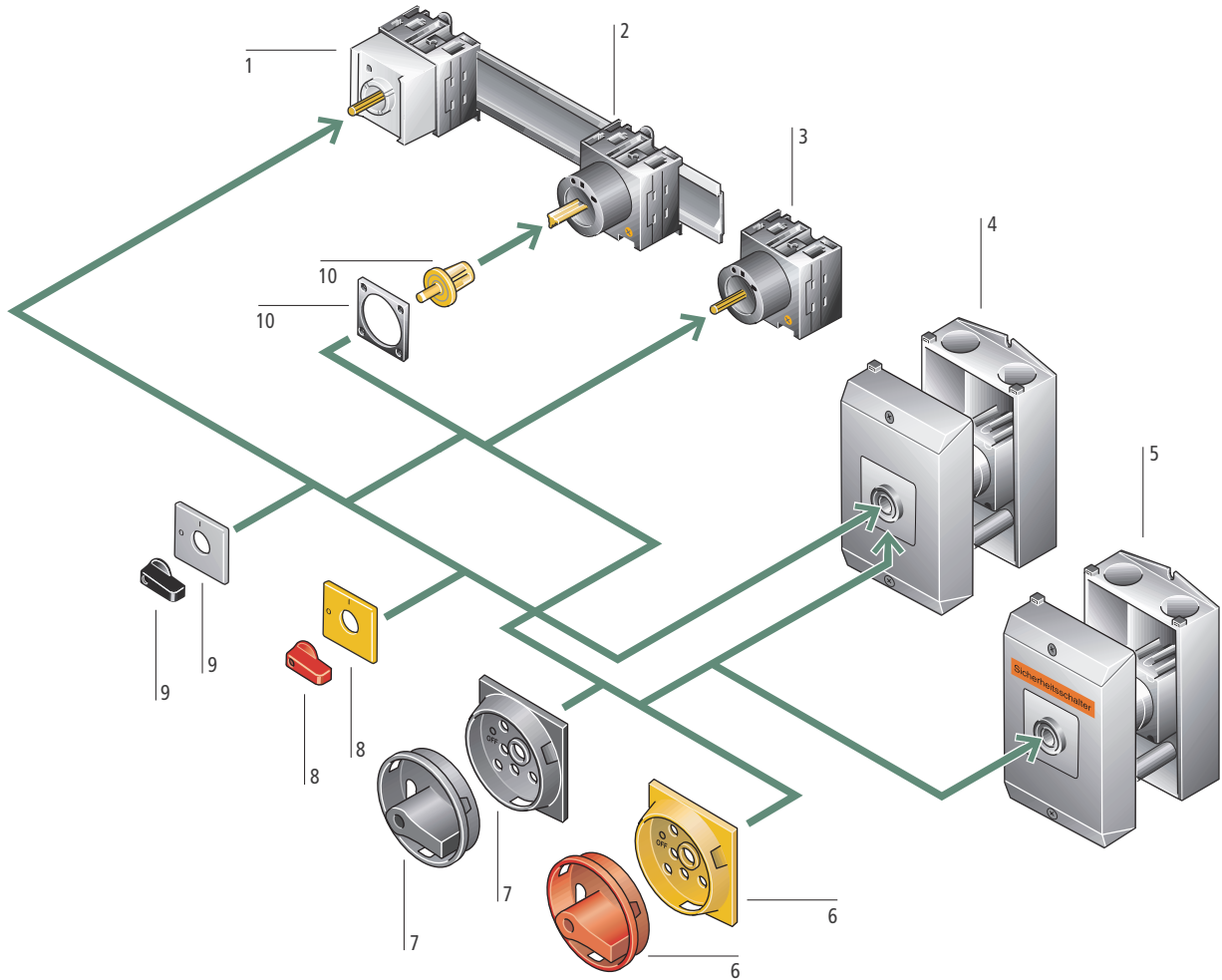

T0, T3, T5B, T5 control switches

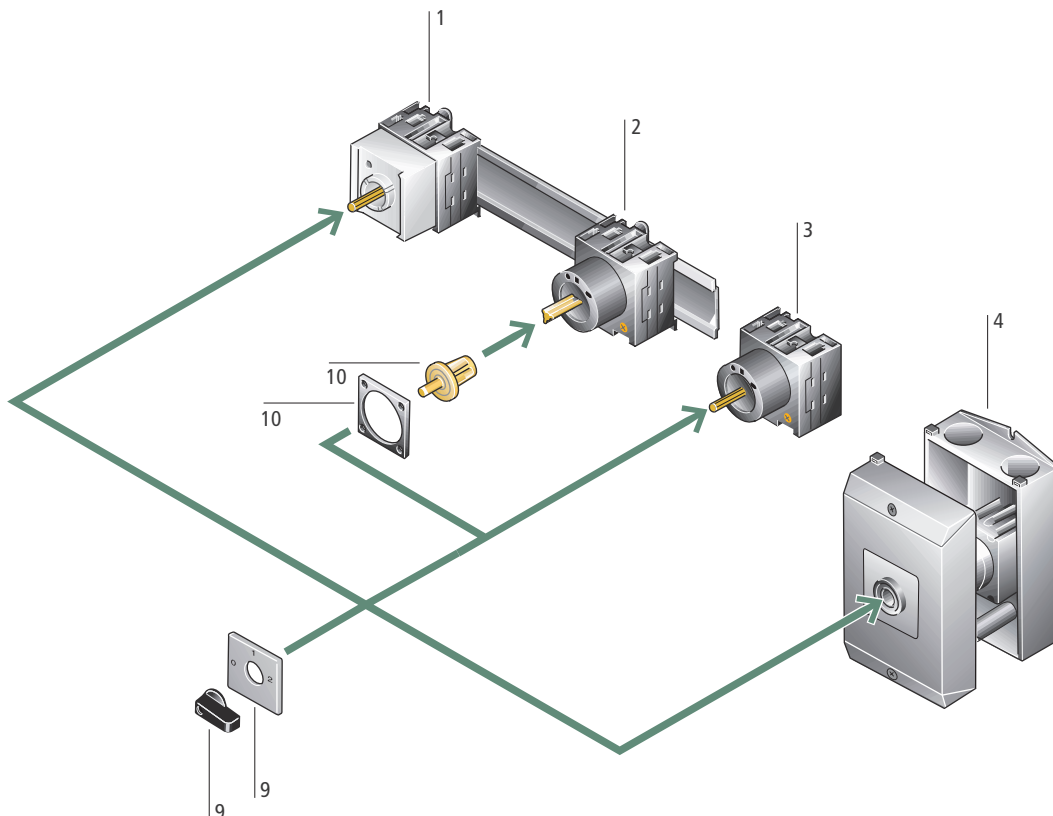

Moeller HPL0211-2004/2005

Service distribution board mounting (.../IVS) 1 Front IP 30 For snap fitting to IEC/EN 60715 top-hat rail Flush mounting Up to 3 contact units in service distribution board (45 mm mounting depth) Up to 11 contact units in control panel → Page 7/17	Centre mounting (.../EZ) 3 Front IP65 Mounting in \varnothing 22.3 fixing hole to IEC/EN 60 947-5-1 "One-man installation" through centre fixing → Page 7/17	Main switch (assembly kit) for use as Emergency-Stop device 6 To IEC/EN 60 204-1, VDE 0113 Part 1 With red rotary handle and yellow locking collar Lockable in the 0 (Off) position → Page 7/49
Rear mounting (.../Z) 2 Front IP65 Secured by screw fixing or snap fitting (T0, T3) For snap fitting to IEC/EN 60715 top-hat rail Coupling drive in door or cover Connection from the front → Page 7/17	Surface mounting (.../I...) 4 IP65 totally insulated With one additional terminal Enclosures designed for metric cable glands to EN 50262 → Page 7/17	Main switch (assembly kit) 7 Black rotary handle and locking collar Lockable in the 0 (Off) position → Page 7/49
Rear mounting main switch (.../V/SVB) 2 Front IP65 To IEC/EN 60204, VDE 0113 and IEC/EN 60947-3, Up to 8 contacts with T0..., and up to 12 contacts with T3... With door interlock in the I (On) position → Page 7/11	Surface mounting main switch (.../I...) 4 IP65 totally insulated To IEC/EN 60204, VDE 0113 and IEC/EN 60947-3, Up to 8 contacts with T0..., and up to 10 contacts with T3... Lockable in the 0 (Off) position using 3 padlocks Enclosures designed for metric cable glands to EN 50262 With one additional terminal → Page 7/11	Thumb-grip, for use as Emergency-Stop device 8 To IEC/EN 60 204-1, VDE 0113 Part 1 Red thumb-grip with yellow front plate → Page 7/49
Flush mounting (.../E) 3 Front IP65 Installation and connection from the rear Terminal: Pozidriv plus-minus screw Finger- and back-of-hand proof T8 with extension terminals as standard → Page 7/16	Safety switch (.../I...) 5 IP65 totally insulated With one additional terminal With cover fixing in the 0 (Off) position Lockable in the 0 (Off) position using 3 padlocks Enclosures designed for metric cable glands to EN 50262 With "Safety switch" label Colour: orange → Page 7/20	Thumb-grip 9 Black thumb-grip with front plate → Page 7/49
Flush mounting main switch (.../EA/SVB) 3 Front IP65 To IEC/EN 60 204, VDE 0113 and IEC/EN 60947-3, Up to 8 contacts with T0..., and up to 12 contacts with T3... N and PE terminals → Page 7/10		Coupling drive 10 Includes push-fit shaft For retrofitting of T0(T3)-.../XZ basic switches in rear mounting form Spare part for T0(T3)/(P1)-.../Z For conversion of T5(B)-.../E flush mounting switches to rear mounting switches Spare part for T5(B)/(P3)-.../Z → Page 7/51



P1, P3 On-Off switches

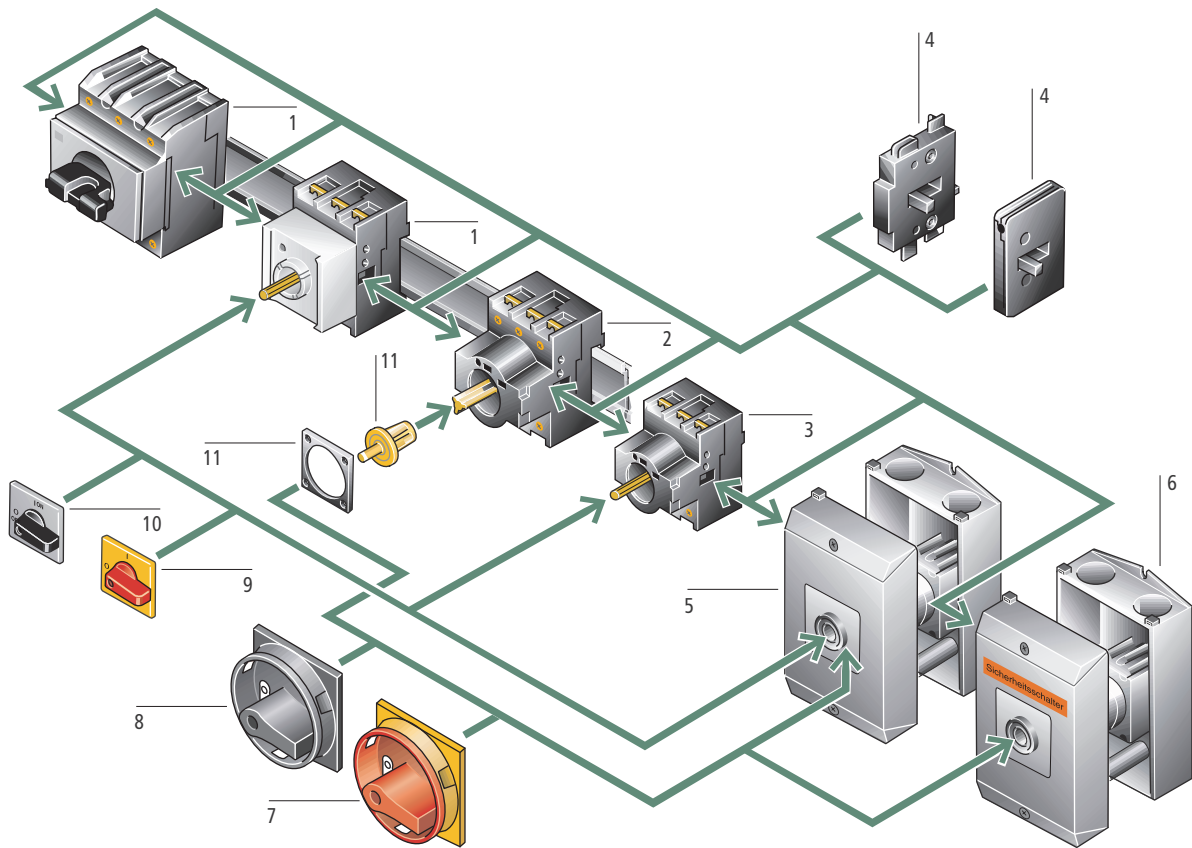

P5 On-Off switches

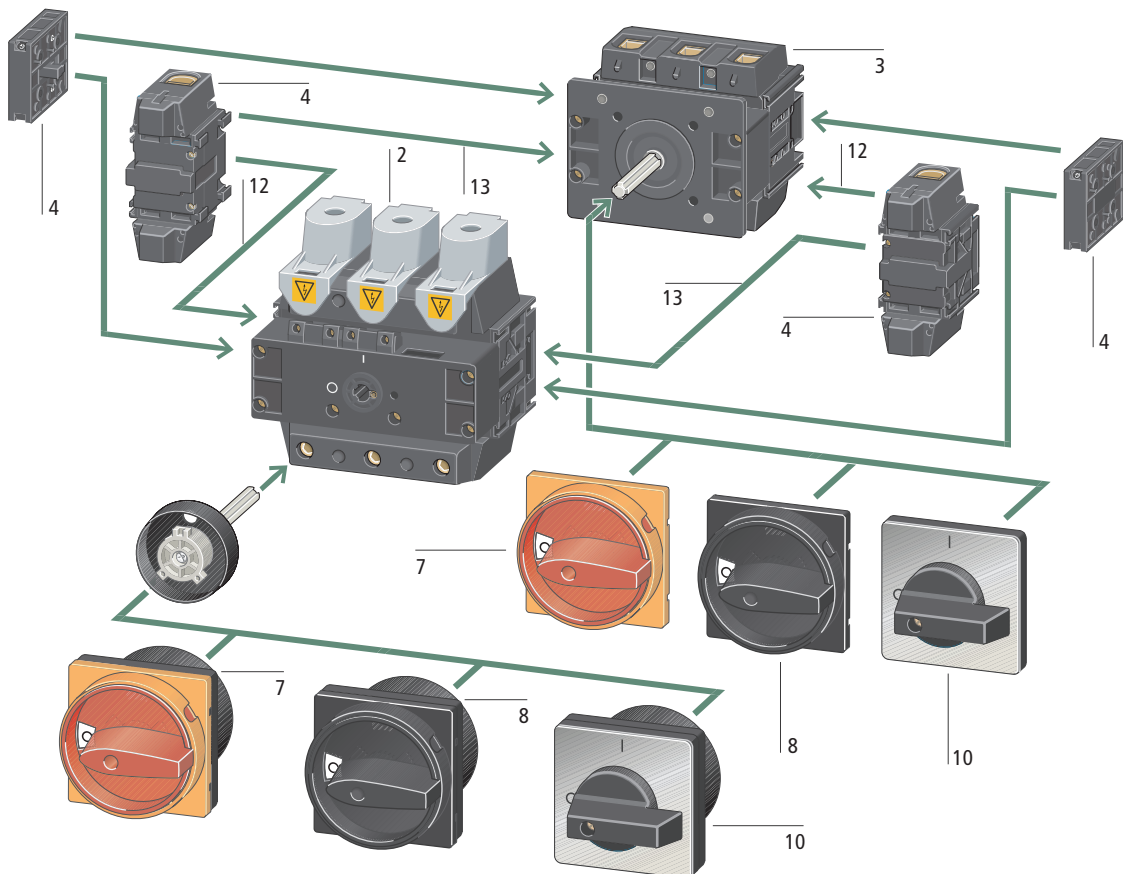

Moeller HPL0211-2004/2005

Service distribution board mounting (.../IVS) 1 Front IP 30 Fitting dimensions to DIN 43880 For snap fitting to IEC/EN 60715 top-hat rail Space requirement P1, 3-pole: 3 space units P3, 3-pole: 4 space units P3-.../IVS lockable in the 0 (Off) position using the padlocking feature → Page 7/17	Flush mounting main switch (.../EA/SVB) 3 Front IP65 To IEC/EN 60204, VDE 0113 and IEC/EN 60947-3 N and PE terminals Lockable in the 0 (Off) position using 3 padlocks 2 add-on modules can be fitted (or retrofitted) → Page 7/10	Safety switch (.../I...) 6 IP65 totally insulated With one additional terminal With cover fixing in the 0 (Off) position Lockable in the 0 (Off) position using 3 padlocks With "Safety switch" label Colour: orange Enclosures designed for metric cable glands to EN 50262 → Page 7/20
Rear mounting (.../Z) 2 Front IP65 Secured by screw fixing or snap fitting For snap fitting to IEC/EN 60715 top-hat rail Coupling drive in door or cover Connection from the front 2 add-on modules can be fitted (or retrofitted) → Page 7/17	Centre mounting (.../EZ) 3 Front IP65 Mounting in \varnothing 22.3 fixing hole to IEC/EN 60 947-5-1 "One-man installation" through centre fixing → Page 7/17	Main switch (assembly kit) for use as Emergency-Stop device 7 To IEC/EN 60204-1, VDE 0113 Part 1 With red rotary handle and yellow locking collar Lockable in the 0 (Off) position → Page 7/49
Rear mounting main switch (.../V/SVB) 2 Front IP65 To IEC/EN 60 204, VDE 0113 and IEC/EN 60 947-3 With door interlock in the I (On) position Maintenance key for commissioning or fault retrieval Lockable in the 0 (Off) position using 3 padlocks 2 add-on modules can be fitted (or retrofitted) → Page 7/11	Add-on modules 4 Switched neutral (early-make contact) Auxiliary contacts Finger proof Auxiliary make contact: always connected as load-shedding contact (late make, early break) → Page 7/50	Main switch (assembly kit) 8 Black rotary handle and locking collar Lockable in the 0 (Off) position → Page 7/49
Flush mounting (.../E) 3 Front IP65 Installation and connection from the rear Terminal: Pozidriv plus-minus screw Finger- and back-of-hand proof 2 add-on modules can be fitted (or retrofitted) → Page 7/16	Surface mounting (.../I...) 5 IP65 totally insulated With one additional terminal Add-on modules for retrofitting: P1: + 1, P3: + 2 Enclosures designed for metric cable glands to EN 50262 → Page 7/17	Thumb-grip, for use as Emergency-Stop device 9 To IEC/EN 60204-1, VDE 0113 Part 1 Red thumb-grip with yellow front plate → Page 7/49
	Surface mounting main switch (.../I...) 5 IP65 totally insulated With one additional terminal To IEC/EN 60204, VDE 0113 and IEC/EN 60947-3 Lockable in the 0 (Off) position using 3 padlocks Add-on modules for retrofitting: P1: +1, P3: +2 Enclosures designed for metric cable glands to EN 50262 → Page 7/11	Thumb-grip 10 Black thumb-grip with front plate → Page 7/49
		Coupling drive 11 Includes push-fit shaft For retrofitting of T0(T3)-.../XZ basic switches in rear mounting form Spare part for T0(T3)/(P1)-.../Z For conversion of T5(B)-.../E flush mounting switches to rear mounting switches Spare part for T5(B)/(P3)-...Z → Page 7/51
		Earth terminal 12 Front fitting: right-hand side service distribution board mounting: left-hand side
		Neutral terminal 13 Front fitting: right-hand side service distribution board mounting: left-hand side



Rotary switches can be used for numerous switching and control tasks. For example as On-Off switches, main switches, main/auxiliary current control switches, instrument switches.

These switches consist of a handle, the basic switch and the mounting accessories.

The contact chamber (contact unit) contains 1 or 2 contacts.

Our "T Rotary Switches" catalogue, K115, shows more than 800 frequently used standard contact sequences (available on request).

On the following Pages, you will find a selection of the standard contact sequences we offer.

T rotary switches and P switch-disconnectors are manufactured without PCB, CFCs, asbestos and silicone. The contacts are cadmium free.

The CI-K... insulated enclosures do not contain silicone and are halogen free.

Technical Data for CI-K small enclosures:
→ Page 14/74

T0 and T3 Rotary Switches

Key to type references

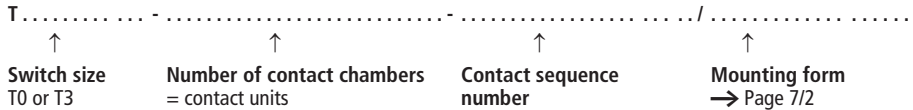

Using the modular system to convert the mounting form

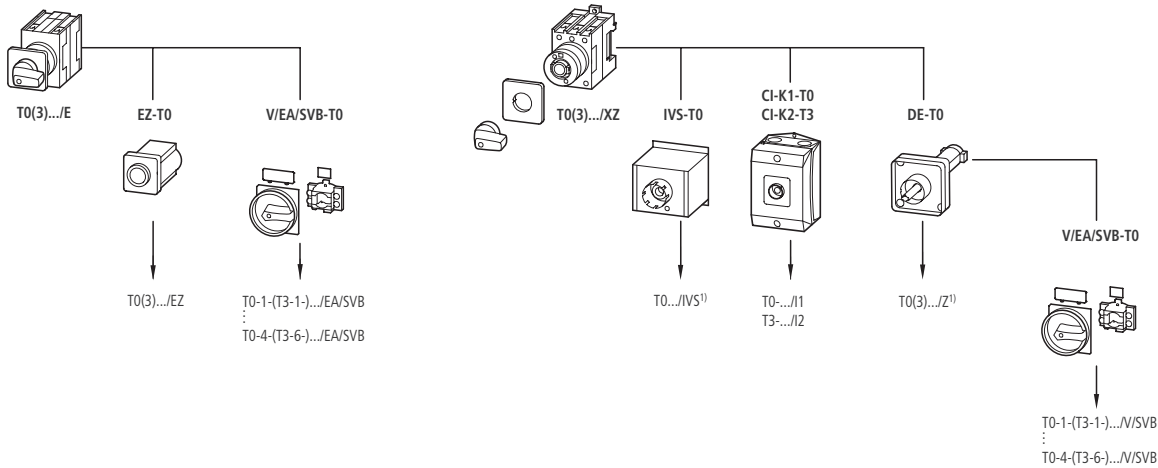

Rotary switches T5(B)

Key to type references

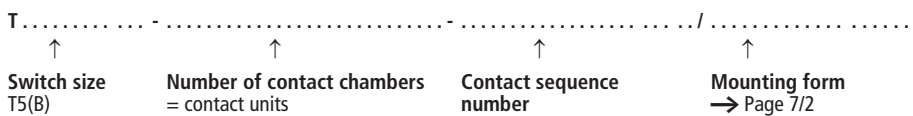

Using the modular system to convert the mounting form of T5(B)

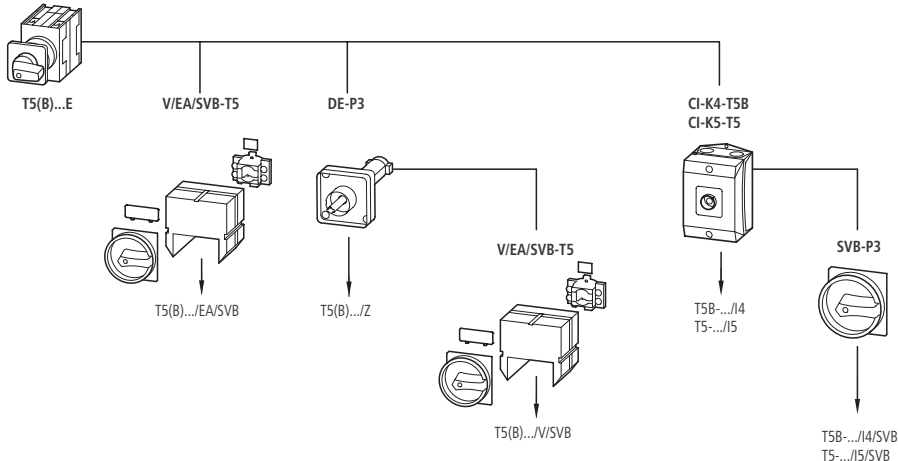

Notes

1) Including shaft

Moeller HPL0211-2004/2005

P1 and P3 switch-disconnectors

Key to type references



The modular system offers add-on functions

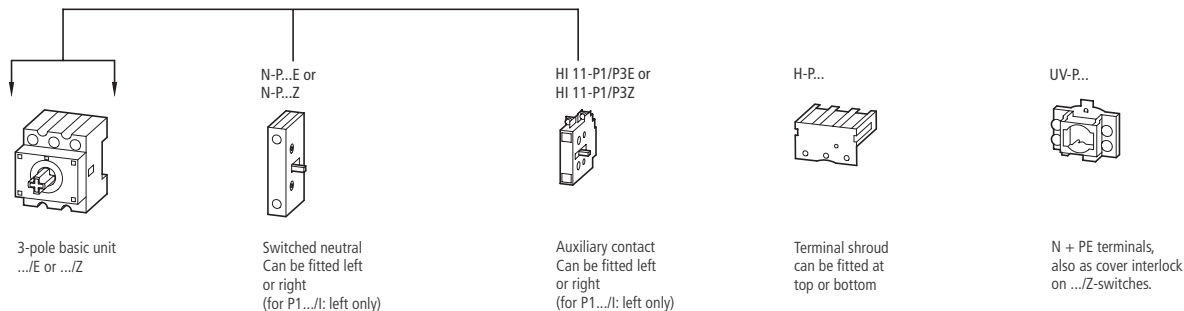

TM mini rotary switches

The TM rotary switch requires very little space due to its exceptionally small dimensions. It is particularly well suited for switching the low voltages and currents that occur in electronic control panels, for example. The gold-plated contacts provide extra reliability and safety.

The terminals of the TM switches are numbered consecutively, starting at 1.

Selection Pages: from → Page 7/56

Key to type references

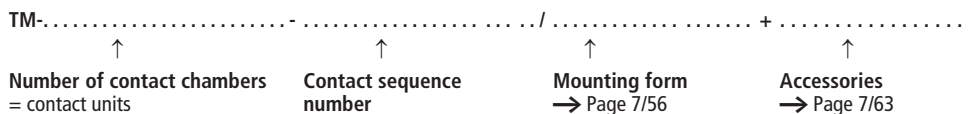

Circuit diagrams

on Pages 7/10 – 43
and 7/56 – 62

Example:

(see also Ordering Example on Page 7/111)

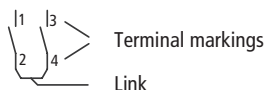

Switch position 1:
Contact 1 – 2 open,
Contact 3 – 4 closed.

Switching from 1 to 2:
Contact 1 – 2 closes with early make,
Contact 3 – 4 opens with late break.

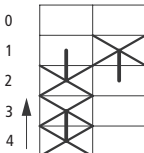
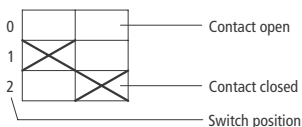

Switching from 2 to 3:
Contact 1 – 2 opens briefly.

Switching from 3 to 4:
Contact 1 – 2 remains closed,
Automatic return from 4 to 3.



Moeller HPL0211-2004/2005

Contact sequence 	Front plate no. 	Main contacts No. of poles M 	Auxiliary contacts M 	B 	Max. three-phase motor rating AC-23A 400/415 V 50-60 Hz	Rated uninterrupted current I_u A	Basic type, insert mounting form identifier	For use as Emergency-Stop devices ¹⁾ Flush mounting Front IP65 	Mounting form type Article no.	Price See Price List
----------------------	---------------------	--	-----------------------------	-------	--	---	---	---	-----------------------------------	-------------------------

Main switches without auxiliary contacts										
	1	0	0	6.5	20	T0-1-8200/...	EA/SVB 053110			
				13	32	T3-1-8200/...	EA/SVB 066576			
				22	63	T5B-1-8200/...	EA/SVB 094279			
				30	100	T5-1-8200/...	EA/SVB 097224			
	2	0	0	6.5	20	T0-1-102/...	EA/SVB 091078			
				13	32	T3-1-102/...	EA/SVB 014374			
				22	63	T5B-1-102/...	EA/SVB 094469			
				30	100	T5-1-102/...	EA/SVB 098808			
	3	0	0	6.5	20	T0-2-1/...	EA/SVB 038873			
				13	25	P1-25/...	EA/SVB 041097			
				15	32	P1-32/...	EA/SVB 081438			
				37	63	P3-63/...	EA/SVB 031607			
50	100	P3-100/...	EA/SVB 074320							
	3 + N	0	0	6.5	20	T0-2-8900/...	EA/SVB 207400			
				13	25	P1-25/...	EA/SVB/N 081587			
				15	32	P1-32/...	EA/SVB/N 091079			
				37	63	P3-63/...	EA/SVB/N 010398			
50	100	P3-100/...	EA/SVB/N 019890							
	6	0	0	6.5	20	T0-3-8342/...	EA/SVB 029382			
				13	32	T3-3-8342/...	EA/SVB 071326			
				22	63	T5B-3-8342/...	EA/SVB 092308			
				30	100	T5-3-8342/...	EA/SVB 096383			
	8	0	0	6.5	20	T0-4-8344/...	EA/SVB 008267			
				13	32	T3-4-8344/...	EA/SVB 008964			
				22	63	T5B-4-8344/...	EA/SVB 092062			
				30	100	T5-4-8344/...	EA/SVB 095961			

Notes ¹⁾ To IEC/EN 60204-1, VDE 0113, Part 1 with red rotary handle and yellow locking collar, lockable in the 0 position
²⁾ With black rotary handle and locking collar, lockable in the 0 position

Moeller HPL0211-2004/2005

For use as Emergency-Stop devices ¹⁾ Surface mounting IP65 	For use as Emergency-Stop devices ¹⁾ Rear mounting Front IP65 	Without Emergency-Stop function ²⁾ Flush mounting Front IP65 	Without Emergency-Stop function ²⁾ Surface mounting IP65 	Without Emergency-Stop function ²⁾ Rear mounting Front IP65 	Std. pack
Mounting form type Article no.	Price See Price List	Mounting form type Article no.	Price See Price List	Mounting form type Article no.	Price See Price List

11/SVB 207145	V/SVB 057856	EA/SVB-SW 055483	11/SVB-SW 207146	V/SVB-SW 060229	1 off
12/SVB 207200	V/SVB 007255	EA/SVB-SW 068949	12/SVB-SW 207201	V/SVB-SW 004882	
14/SVB 207240	V/SVB 094273	EA/SVB-SW 094278	14/SVB-SW 207241	V/SVB-SW 094272	
15/SVB 207275	V/SVB 097222	EA/SVB-SW 097223	15/SVB-SW 207276	V/SVB-SW 097221	
11/SVB 207143	V/SVB 095824	EA/SVB-SW 093451	11/SVB-SW 207144	V/SVB-SW 022330	
12/SVB 207198	V/SVB 019120	EA/SVB-SW 016747	12/SVB-SW 207199	V/SVB-SW 021493	
14/SVB 207238	V/SVB 094463	EA/SVB-SW 094468	14/SVB-SW 207239	V/SVB-SW 094462	
15/SVB 207273	V/SVB 098806	EA/SVB-SW 098807	15/SVB-SW 207274	V/SVB-SW 098805	
11/SVB 207147	V/SVB 043619	EA/SVB-SW 041246	11/SVB-SW 207148	V/SVB-SW 045992	
12/SVB 207293	V/SVB 055335	EA/SVB-SW 048365	12/SVB-SW 207294	V/SVB-SW 050738	
12/SVB 207314	V/SVB 095676	EA/SVB-SW 053111	12/SVB-SW 207315	V/SVB-SW 055484	
14/SVB 207343	V/SVB 048218	EA/SVB-SW 057857	14/SVB-SW 207344	V/SVB-SW 060230	
15/SVB 207373	V/SVB 088558	EA/SVB-SW 062603	15/SVB-SW 207374	V/SVB-SW 064976	
11/SVB 207151	V/SVB 207405	EA/SVB-SW 207401	11/SVB-SW 207152	V/SVB-SW 207406	
12/SVB/N 207298	V/SVB/N 086333	EA/SVB-SW/N 083960	12/SVB-SW/N 207296	V/SVB-SW/N 088706	
12/SVB/N 207319	V/SVB/N 095825	EA/SVB-SW/N 093452	12/SVB-SW/N 207317	V/SVB-SW/N 098198	
14/SVB/N 207349	V/SVB/N 015144	EA/SVB-SW/N 012771	14/SVB-SW/N 207346	V/SVB-SW/N 017517	
15/SVB/N 207379	V/SVB/N 024636	EA/SVB-SW/N 022263	15/SVB-SW/N 207376	V/SVB-SW/N 027009	
11/SVB 207159	V/SVB 034128	EA/SVB-SW 031755	11/SVB-SW 207160	V/SVB-SW 036501	
12/SVB 207208	V/SVB 076072	EA/SVB-SW 073699	12/SVB-SW 207209	V/SVB-SW 078445	
14/SVB 207242	V/SVB 092300	EA/SVB-SW 092307	14/SVB-SW 207243	V/SVB-SW 092299	
15/SVB 207279	V/SVB 096381	EA/SVB-SW 096382	15/SVB-SW 207280	V/SVB-SW 096380	
11/SVB 207163	V/SVB 014007	EA/SVB-SW 008268	11/SVB-SW 207164	V/SVB-SW 008272	
12/SVB 207212	V/SVB 020598	EA/SVB-SW 008965	12/SVB-SW 207213	V/SVB-SW 008967	
14/SVB 207248	V/SVB 092056	EA/SVB-SW 092061	14/SVB-SW 207249	V/SVB-SW 092055	
15/SVB ³⁾ 207283	V/SVB 095959	EA/SVB-SW 095960	15/SVB-SW ³⁾ 207284	V/SVB-SW 095958	

³⁾ T5-4-8344/15... max. 95 A

Moeller HPL0211-2004/2005

<p>Contact sequence</p>	<p>Front plate no.</p>	<p>Main contacts</p> <p>No. of poles</p> <p>M</p>	<p>Auxiliary contacts</p> <p>M</p> <p>B</p>	<p>Max. three-phase motor rating</p> <p>AC-23A 400/415 V 50-60 Hz</p>	<p>Rated uninterrupted current</p> <p>I_u A</p>	<p>For use as Emergency-Stop devices¹⁾</p> <p>Flush mounting Front IP65</p>	<p>Basic type, insert mounting form identifier</p>	<p>Mounting form type Article no.</p>	<p>Price See Price List</p>
-------------------------	------------------------	---	---	---	--	--	--	---------------------------------------	-----------------------------

Main switches with auxiliary contacts			Max. three-phase motor rating	Rated uninterrupted current	Basic type, insert mounting form identifier	Mounting form type Article no.	Price See Price List
	3	1	0	6.5	20	T0-2-15679/...	EA/SVB 081588
	3	1	1	13	25	P1-25/...	EA/SVB/HI11 091080
				15	32	P1-32/...	EA/SVB/HI11 072567
				37	63	P3-63/...	EA/SVB/HI11 019891
	3	2	1	6.5	20	T0-3-15683/...	EA/SVB 015571
				13	32	T3-3-15683/...	EA/SVB 040478
	3 + N	1	1	6.5	20	T0-3-15680/...	EA/SVB 038875
				13	32	T3-3-15680/...	EA/SVB 012002
				13	25	P1-25/...	EA/SVB/N/HI11 048367
	3 + N	1	1	15	32	P1-32/...	EA/SVB/N/HI11 057859
				37	63	P3-63/...	EA/SVB/N/HI11 067351
				50	100	P3-100/...	EA/SVB/N/HI11 076843
	3 + N	1	1	6.5	20	T0-3-8901/...	EA/SVB 231932
				13	32	T3-3-8901/...	EA/SVB 231945
				22	63	T5B-3-8901/...	EA/SVB 207420
				30	100	T5-3-8901/...	EA/SVB 207408
	6	1	1	6.5	20	T0-4-15682/...	EA/SVB 019892
				13	32	T3-4-15682/...	EA/SVB 054716
				22	63	T5B-4-15682/...	EA/SVB 207425
				30	100	T5-4-15682/...	EA/SVB 207413

Notes ¹⁾ To IEC/EN 60 204-1, VDE 0113, Part 1 with red rotary handle and yellow locking collar, lockable in the 0 position
²⁾ With black rotary handle and locking collar, lockable in the 0 position

Moeller HPL0211-2004/2005

<p>For use as Emergency-Stop devices¹⁾</p> <p>Surface mounting IP65</p>	<p>For use as Emergency-Stop devices¹⁾</p> <p>Rear mounting Front IP65</p>	<p>Without Emergency-Stop function²⁾</p> <p>Flush mounting Front IP65</p>	<p>Without Emergency-Stop function²⁾</p> <p>Surface mounting IP65</p>	<p>Without Emergency-Stop function²⁾</p> <p>Rear mounting Front IP65</p>	<p>Mounting form type Article no.</p>	<p>Price See Price List</p>	<p>Mounting form type Article no.</p>	<p>Price See Price List</p>	<p>Mounting form type Article no.</p>	<p>Price See Price List</p>	<p>Mounting form type Article no.</p>	<p>Price See Price List</p>	<p>Std. pack</p>
--	---	--	--	---	---------------------------------------	-----------------------------	---------------------------------------	-----------------------------	---------------------------------------	-----------------------------	---------------------------------------	-----------------------------	------------------

11/SVB 207149	V/SVB 086334	EA/SVB-SW 083961	11/SVB-SW 207150	V/SVB-SW 088707								1 off
12/SVB/HI11 207297	V/SVB/HI11 095826	EA/SVB-SW/HI11 070194	12/SVB-SW/HI11 207295	V/SVB-SW/HI11 098199								
12/SVB/HI11 207318	V/SVB/HI11 015145	EA/SVB-SW/HI11 012772	12/SVB-SW/HI11 207316	V/SVB-SW/HI11 017518								
14/SVB/HI11 207348	V/SVB/HI11 024637	EA/SVB-SW/HI11 022264	14/SVB-SW/HI11 207345	V/SVB-SW/HI11 027010								
15/SVB/HI11 207378	V/SVB/HI11 034129	EA/SVB-SW/HI11 031756	15/SVB-SW/HI11 207375	V/SVB-SW/HI11 036502								
11/SVB 207157	V/SVB 015634	EA/SVB-SW 015600	11/SVB-SW 207158	V/SVB-SW 015664								
12/SVB 207206	V/SVB 045224	EA/SVB-SW 042851	12/SVB-SW 207207	V/SVB-SW 047597								
11/SVB 207153	V/SVB 043621	EA/SVB-SW 041248	11/SVB-SW 207154	V/SVB-SW 045994								
12/SVB 207202	V/SVB 016748	EA/SVB-SW 014375	12/SVB-SW 207203	V/SVB-SW 019121								
	V/SVB/N/HI11 053113	EA/SVB-SW/N/HI11 050740		V/SVB-SW/N/HI11 055486								
	V/SVB/N/HI11 062605	EA/SVB-SW/N/HI11 060232		V/SVB-SW/N/HI11 064978								
14/SVB/N/HI11 207350	V/SVB/N/HI11 072097	EA/SVB-SW/N/HI11 069724	14/SVB-SW/N/HI11 207347	V/SVB-SW/N/HI11 074470								
15/SVB/N/HI11 207380	V/SVB/N/HI11 081589	EA/SVB-SW/N/HI11 079216	15/SVB-SW/N/HI11 207377	V/SVB-SW/N/HI11 083962								
11/SVB 231934	V/SVB 231936	EA/SVB-SW 231933	11/SVB-SW 231935	V/SVB-SW 231937								
12/SVB 218987	V/SVB 231947	EA/SVB-SW 231946	12/SVB-SW 218988	V/SVB-SW 231948								
14/SVB 207244	V/SVB 207422	EA/SVB-SW 207421	14/SVB-SW 207245	V/SVB-SW 207423								
15/SVB 207277	V/SVB 207410	EA/SVB-SW 207409	15/SVB-SW 207278	V/SVB-SW 207411								
11/SVB 207161	V/SVB 024638	EA/SVB-SW 022265	11/SVB-SW 207162	V/SVB-SW 027011								
12/SVB 207210	V/SVB 059462	EA/SVB-SW 057089	12/SVB-SW 207211	V/SVB-SW 061835								
14/SVB 207246	V/SVB 207427	EA/SVB-SW 207426	14/SVB-SW 207247	V/SVB-SW 207428								
15/SVB 207281	V/SVB 207415	EA/SVB-SW 207414	15/SVB-SW 207282	V/SVB-SW 207416								

Rotary Switches, Switch-Disconnectors

Rotary Switches, Switch-Disconnectors

Moeller HPL0211-2004

Contact sequence	Front plate no.	Main contacts	Auxiliary contacts	Max. three-phase motor rating	Rated uninterrupted current	For use as Emergency-Stop devices ¹⁾	
		No. of poles		AC-23A 400/415 V 50-60 Hz	I_u A	Flush mounting Front IP65	
		M	M	P kW		Basic type, insert mounting form identifier	Mounting form type Article no. Price See Price List
Main switches without auxiliary contacts							
	3	0	0	45	125	P5-125/...	EA/SVB 280898
				55	160	P5-160/...	EA/SVB 280922
				90	250	P5-250/...	EA/SVB 280936
				110	315	P5-315/...	EA/SVB 280950
	3 + N			45	125	P5-125/...	EA/SVB/N 280910
				55	160	P5-160/...	EA/SVB/N 280924
				90	250	P5-250/...	EA/SVB/N 280938
				110	315	P5-315/...	EA/SVB/N 280952
Main switches with auxiliary contacts							
	3	1	0	45	125	P5-125/...	EA/SVB/HI10 280899
				55	160	P5-160/...	EA/SVB/HI10 280923
				90	250	P5-250/...	EA/SVB/HI10 280937
				110	315	P5-315/...	EA/SVB/HI10 280951
	6	1	1	55	160	T6-160-6/...	
				132	315 ³⁾	T8-3-8342/...	

- Notes**
- ¹⁾ To IEC/EN 60 204-1, VDE 0113, Part 1 with red rotary handle and yellow locking collar, lockable in the 0 position
 - ²⁾ With black rotary handle and locking collar, lockable in the 0 position
 - ³⁾ Rated uninterrupted current, 315 A: in enclosed version up to 275 A
 - ⁴⁾ Enclosures without flanges, with K95/1N/BR
 - ⁵⁾ With KS4-CI and K150/1/BR, IP64



Moeller HPL0211-2004

For use as Emergency-Stop devices ¹⁾		For use as Emergency-Stop devices ¹⁾		Without Emergency-Stop function ²⁾		Without Emergency-Stop function ²⁾		Without Emergency-Stop function ²⁾		Std. pack
Surface mounting IP65		Rear mounting Front IP65		Flush mounting Front IP65		Surface mounting IP65		Rear mounting Front IP65		
Mounting form type Article no.	Price See Price List	Mounting form type Article no.	Price See Price List	Mounting form type Article no.	Price See Price List	Mounting form type Article no.	Price See Price List	Mounting form type Article no.	Price See Price List	
		V/SVB 280914		EA/SVB-SW 280911				V/SVB-SW 280917		1 off
		V/SVB 280928		EA/SVB-SW 280925				V/SVB-SW 280931		
		V/SVB 280942		EA/SVB-SW 280939				V/SVB-SW 280945		
		V/SVB 280956		EA/SVB-SW 280953				V/SVB-SW 280959		
		V/SVB/N 280916		EA/SVB-SW/N 280913				V/SVB-SW/N 280919		
		V/SVB/N 280930		EA/SVB-SW/N 280927				V/SVB-SW/N 280933		
		V/SVB/N 280944		EA/SVB-SW/N 280941				V/SVB-SW/N 280947		
		V/SVB/N 280958		EA/SVB-SW/N 280955				V/SVB-SW/N 280961		
		V/SVB/HI10 280915		EA/SVB-SW/HI10 280912				V/SVB-SW/HI10 280918		1 off
		V/SVB/HI10 280929		EA/SVB-SW/HI10 280926				V/SVB-SW/HI10 280932		
		V/SVB/HI10 280943		EA/SVB-SW/HI10 280940				V/SVB-SW/HI10 280946		
		V/SVB/HI10 280957		EA/SVB-SW/HI10 280954				V/SVB-SW/HI10 280960		
I45/SVB/HI11 ⁴⁾ 201448		V/SVB/HI11 200619				I45/SVB-SW/HI11 ⁴⁾ 201447		V/SVB-SW/HI11 200127		
I48/SVB/HI11 ⁵⁾ 201450		V/SVB/HI11 200620				I48/SVB-SW/HI11 ⁵⁾ 201449		V/SVB-SW/HI11 200128		

Moeller HPL0211-2004/2005

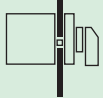

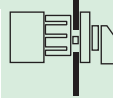

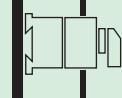
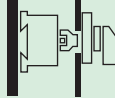
Moeller HPL0211-2004/2005

Contact sequence 	Front plate no. FS 908	Main contacts No. of poles	Auxiliary contacts	Max. three-phase motor rating AC-23A 400/415 V 50-60 Hz	Rated uninterrupted current	Flush mounting Front IP65 			
		M	M	B	P kW	I _u A	Basic type, insert mounting form identifier	Mounting form type Article no.	Price See Price List

Centre mounting Front IP65 	Surface mounting IP65 	Service distribution board mounting Front IP 30 	Rear mounting Front IP65 				
Mounting form type Article no.	Price See Price List	Mounting form type Article no.	Price See Price List	Mounting form type Article no.	Price See Price List	Mounting form type Article no.	Price See Price List

On-Off switches without auxiliary contacts

With black thumb-grip and front plate

	1	0	0	6.5	20	T0-1-8200/...	E 067352		
				13	32	T3-1-8200/...	E 064208		
				22	63	T5B-1-8200/...	E 094281		
	2	0	0	6.5	20	T0-1-102/...	E 088709		
				13	32	T3-1-102/...	E 076073		
				22	63	T5B-1-102/...	E 094471		
	3	0	0	6.5	20	T0-2-1/...	E 024639		
				13	25	P1-25/...	E 038724		
				15	32	P1-32/...	E 079065		
				37	63	P3-63/...	E 026861		
				50	100	P3-100/...	E 067201		
				45	125	P5-125/...	E 280897		
				55	160	P5-160/...	E 280921		
				90	250	P5-250/...	E 280935		
				110	315	P5-315/...	E 280949		
	3 + N	0	0	6.5	20	T0-2-8900/...	E 207398		
				13	25	P1-25/...	E/N 076845		
				15	32	P1-32/...	E/N 093456		
				37	63	P3-63/...	E/N 019894		
				50	100	P3-100/...	E/N 031759		
	6	0	0	6.5	20	T0-3-8342/...	E 043624		
				13	32	T3-3-8342/...	E 045225		
				22	63	T5B-3-8342/...	E 092310		
	8	0	0	6.5	20	T0-4-8344/...	E 014000		
				13	32	T3-4-8344/...	E 020593		
				22	63	T5B-4-8344/...	E 092064		

EZ 069725	I1 207074	IVS 074471	Z 076844
EZ 066581	I2 207167		Z 071327
	I4 207218		Z 094270
EZ 091082	I1 207061	IVS 015147	Z 095828
EZ 078446	I2 207165		Z 083192
	I4 207215		Z 094460
EZ 027012	I1 207081	IVS 031758	Z 036504
EZ 041250	I2 207299	IVS 052962	Z 057708
EZ 048369	I2 207320	IVS 093303	Z 098049
	I4 207356	IVS 041099	Z 050591
	I5 207381	IVS 081439	Z 090931
			Z 280920
			Z 280934
			Z 280948
			Z 280962
EZ 207402	I1 207109	IVS 207403	Z 207407
EZ/N 079218	I2/N 207303	IVS/N 083964	Z/N 088710
EZ/N 095829	I2/N 207324	IVS/N 010402	Z/N 015148
	I4/N 207360	IVS/N 022267	Z/N 027013
	I5/N 207385	IVS/N 034132	Z/N 038878
EZ 045997	I1 207131	IVS 050743	Z 055489
EZ 047598	I2 207187		Z 052344
	I4 207226		Z 092297
EZ 014002	I1 207139	IVS 014006	Z 014009
EZ 020595	I2 207194		Z 020600
	I4 207233		Z 092053

Std. pack

1 off

Moeller HPL0211-2004/2005

Contact sequence 	Front plate no. FS 908	Main contacts No. of poles	Auxiliary contacts	Max. three-phase motor rating AC-23A 400/415 V 50-60 Hz	Rated uninterrupted current I_u A
		M	M	P	
				kW	
			B		



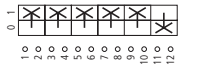
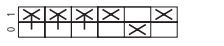
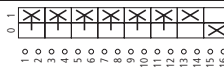

On-Off switches with auxiliary contacts

With black thumb-grip and front plate

	3	1	0	6.5	20	T0-2-15679/...	E 029387		
		2	1	6.5	20	T0-3-8901/...	E 231938		
				13	32	T3-3-8901/...	E 231949		
				6.5	20	T0-3-15683/...	E 016619		
				13	32	T3-3-15683/...	E 014377		
	6	1	1	6.5	20	T0-4-15682/...	E 010405		
				13	32	T3-4-15682/...	E 023869		
				22	63	T5B-4-15682/...	E 207424		
				30	100	T5-4-15682/...	E 207412		

On-Off switches for use as Emergency-Stop devices

To IEC/EN 60 204-1, VDE 113 Part 1: with red thumb-grip and yellow front plate

	1	0	0	6.5	20	T0-1-8200/...	E-RT 009474		
				13	32	T3-1-8200/...	E-RT 017025		
				22	63	T5B-1-8200/...	E-RT 094280		
				30	100	T5-1-8200/...	E-RT 097225		
	2	0	0	6.5	20	T0-1-102/...	E-RT 009046		
				13	32	T3-1-102/...	E-RT 016318		
				22	63	T5B-1-102/...	E-RT 094470		
				30	100	T5-1-102/...	E-RT 098809		
	3	0	0	6.5	20	T0-2-1/...	E-RT 011082		
				13	25	P1-25/...	E-RT 002388		
				15	32	P1-32/...	E-RT 003197		
				37	63	P3-63/...	E-RT 005743		
				50	100	P3-100/...	E-RT 007189		
	3 + N	0	0	6.5	20	T0-2-8900/...	E-RT 207399		

Flush mounting

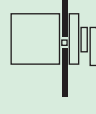
Front IP65 	Mounting form type Article no.	Price See Price List
---	-----------------------------------	-------------------------

Moeller HPL0211-2004/2005

Centre mounting

Front IP65 	Mounting form type Article no.	Price See Price List
---	-----------------------------------	-------------------------

Surface mounting

IP65 	Mounting form type Article no.	Price See Price List
---	-----------------------------------	-------------------------

Service distribution board mounting

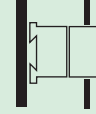

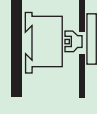

Front IP 30 	Mounting form type Article no.	Price See Price List
--	-----------------------------------	-------------------------

Rear mounting

Front IP65 	Mounting form type Article no.	Price See Price List
---	-----------------------------------	-------------------------

EZ 031760	I1 207094	IVS 036506	Z 041252	1 off
EZ 231939	I1 231941	IVS 231940	Z 231942	
EZ 231950	I2 231951		Z 231952	
EZ 016658	I1 207118	IVS 016722	Z 016843	
EZ 040480	I2 207182		Z 019123	
EZ 012778	I1 207135	IVS 017524	Z 022270	
EZ 026242	I2 207190		Z 030988	
	I4 207229		Z 207429	
	I5 207269		Z 207417	
	I1-RT 207075	IVS-RT 081956		
	I2-RT 207168			
	I4-RT 207219			
	I5-RT 207265			
	I1-RT 207062	IVS-RT 079583		
	I2-RT 207166			
	I4-RT 207216			
	I5-RT 207263			
	I1-RT 207082	IVS-RT 084329		
	I2-RT 207300	IVS-RT 013140		
	I2-RT 207321	IVS-RT 022632		
	I4-RT 207357	IVS-RT 045845		
	I5-RT 207382	IVS-RT 086185		
	I1-RT 207110	IVS-RT 207404		

Moeller HPL0211-2004/2005

Contact sequence	Front plate no.  FS 908	Main contacts No. of poles	Auxiliary contacts	Max. three-phase motor rating AC-23A 400/415 V 50-60 Hz P kW	Rated uninterrupted current I_u A
		M 	M  B 		

For use as Emergency-Stop devices¹⁾

Surface mounting IP65



















 totally insulated



Type Article no. Price See Price List

Safety switches with warning label



	3	0	0	13	25	P1-25/I2-SI 207308
	3	0	0	15	32	P1-32/I2-SI 207329
	3 + N	0	0	13	25	P1-25/I2-SI/N 207312
	3 + N	0	0	15	32	P1-32/I2-SI/N 207333
With auxiliary contacts 	3	1	1	13	25	P1-25/I2-SI/HI11 207310
	3	1	1	15	32	P1-32/I2-SI/HI11 207331
	3	0	0	37	63	P3-63/I4-SI 207361
	3	0	0	50	100	P3-100/I5-SI 207386
	3 + N	0	0	37	63	P3-63/I4-SI/N 207365
	3 + N	0	0	50	100	P3-100/I5-SI/N 207390
With auxiliary contacts 	3	1	1	37	63	P3-63/I4-SI/HI11 207363
	3	1	1	50	100	P3-100/I5-SI/HI11 207388
	6	0	0	22	63	T5B-3-8342/I4-SI 207250
	6	0	0	30	100	T5-3-8342/I5-SI 207447
With auxiliary contacts 	6	1	1	22	63	T5B-4-15682/I4-SI 207254
	6	1	1	30	100	T5-4-15682/I5-SI 207285
With auxiliary contacts 	6	2	0	22	63	T5B-4-8903/I4-SI 207258
	6	2	0	30	100	T5-4-8903/I5-SI 207289

Notes

- Surface mounting IP65: with red rotary handle and yellow locking collar, lockable in the 0 position with cover interlock, to IEC/EN 60204-1, VDE 0113 Part 1
- Surface mounting IP65: with black rotary handle and locking collar, lockable in the 0 position with cover interlock

Moeller HPL0211-2004/2005

Without Emergency-Stop function²⁾

Surface mounting IP65

 totally insulated



Type Article no. Price See Price List

Std. pack

P1-25/I2-SI-SW 207309	1 off
P1-32/I2-SI-SW 207330	
P1-25/I2-SI/N-SW 207313	
P1-32/I2-SI/N-SW 207334	
P1-25/I2-SI/HI11-SW 207311	
P1-32/I2-SI/HI11-SW 207332	
P3-63/I4-SI-SW 207362	
P3-100/I5-SI-SW 207387	
P3-63/I4-SI/N-SW 207366	
P3-100/I5-SI/N-SW 207391	
P3-63/I4-SI/HI11-SW 207364	
P3-100/I5-SI/HI11-SW 207389	
T5B-3-8342/I4-SI-SW 207251	
T5-3-8342/I5-SI-SW 207448	
T5B-4-15682/I4-SI-SW 207255	
T5-4-15682/I5-SI-SW 207286	
T5B-4-8903/I4-SI-SW 207259	
T5-4-8903/I5-SI-SW 207290	

Engineering

Maintenance and safety switches all have the same electrical function. An electrical system (load) must be safely disconnected from the mains for the duration of maintenance or repair work, in order to prevent any risk to personnel, machinery or products. A safety switch is an additional, enclosed main switch = isolator dedicated to an individual electrical load and mounted in the immediate vicinity of this motor or electrical load. It is intended to enable safe working to VDE 0105. This is particularly important if there is any danger of the main switches being mistakenly operated.

Application

By inserting his own padlock (up to 3 can be fitted), each participating fitter/electrician can protect himself from anyone else switching On without authority. Maintenance switches are merely additional, enclosed main switches with padlocking facility.

Features

- Safety switches are housed in insulated enclosures and bear the inscription "Safety switch" on a bright orange label.
- Switches to be used for Emergency-Stop switching have a red handle and yellow locking collar, in accordance with STOP category O to IEC/EN 60204/VDE 0113.
- Switches that are not admissible for use as Emergency-Stop have both parts in black (type suffix "-SW").
- The cover and handle are interlocked when a padlock is in place.

Selection

Switches must be selected according to the following criteria:
 1) The motor switching capacity, where the switch is fitted in such a way that the operator may use it for operational On and Off switching.
 2) The motor rating applies for 3 poles as standard. Where the motor rating is divided between 6 poles, such as for a motor with star-delta starting, the 1.73 fold rating can be controlled with a 6-pole switch.
 3) The uninterrupted current, where the switch has a load-shedding contact (LA). The load-shedding contact is an auxiliary contact that is closed in the On position and opens early when switching Off, such that a contactor in the circuit takes over the switching duty, and the maintenance/safety switch operates at zero load. When switching On, the load-shedding contact closes later than or at the same time as the main contacts. With P and T switches, this is achieved by the auxiliary make contact.
 4) The handle (which may need to be changed accordingly) can be padlocked in the On position. This is not permissible for switches with red/yellow handle.

Safety switch with load shedding and indication

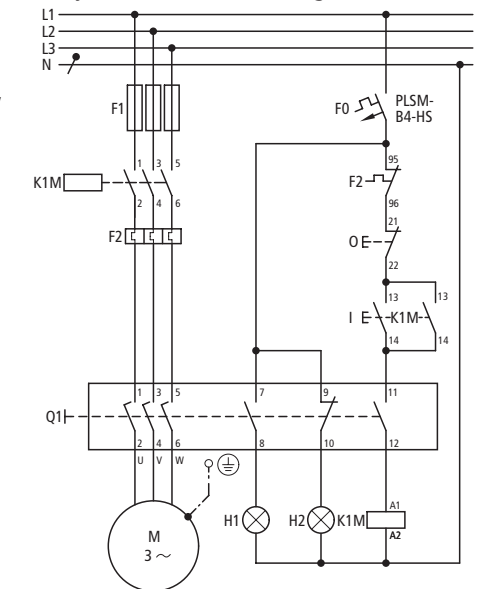



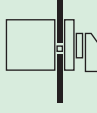









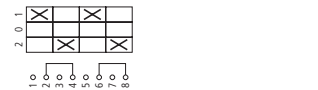

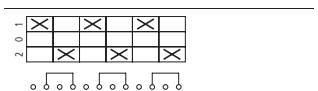

Moeller HPL0211-2004/2005

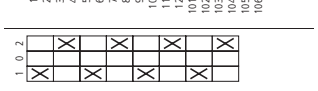
Contact sequence	Front plate no.	No. of poles	Max. three-phase motor rating	Rated uninterrupted current		Flush mounting Front IP65		
			AC-23A 400/415 V 50-60 Hz	I_u A				
		M	P kW		Basic type, insert mounting form identifier	Mounting form type Article no.	Price See Price List	Std. pack

Changeover switches with 0 (Off) position,

With black thumb-grip and front plate

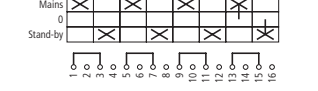
Group switches, mains transfer switches

	 FS 684	1	6.5	20	T0-1-8210/...	E 012742		1 off
			13	32	T3-1-8210/...	E 054718		
			22	63	T5B-1-8210/...	E 094261		
		2	6.5	20	T0-2-8211/...	E 022234		
			13	32	T3-2-8211/...	E 061837		
			22	63	T5B-2-8211/...	E 093094		
		3	6.5	20	T0-3-8212/...	E 029353		
			13	32	T3-3-8212/...	E 068956		
			22	63	T5B-3-8212/...	E 092386		
			30	100	T5-3-8212/...	E 096466		
			45	125	T6-3-8212/...	E/HI12 214781		
			132	315	T8-3-8212/...	E/HI12 214782		
	 FS 684	4	6.5	20	T0-4-8213/...	E 031726		
			13	32	T3-4-8213/...	E 076075		
			22	63	T5B-4-8213/...	E 092112		
			30	100	T5-4-8213/...	E 096014		
			6.5	20	T0-4-8294/...	E 010371		
			13	32	T3-4-8294/...	E 002513		
	 FS 953		22	63	T5B-4-8294/...	E 092084		
			30	100	T5-4-8294/...	E 095986		
			13	32	T3-4-8902/...	E 215222		
	 FS 161629		22	63	T5B-4-8902/...	E 207430		
			30	100	T5-4-8902/...	E 207418		

Moeller HPL0211-2004/2005

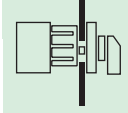
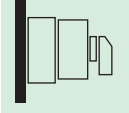
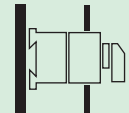
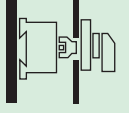
Centre mounting Front IP65			Surface mounting IP65			Service distribution board mounting Front IP 30			Rear mounting Front IP65		
											
Mounting form type Article no.	Price See Price List	Std. pack	Mounting form type Article no.	Price See Price List	Std. pack	Mounting form type Article no.	Price See Price List	Std. pack	Mounting form type Article no.	Price See Price List	Std. pack
EZ 048337		1 off	I1 207076		1 off	IVS 074440		1 off	Z 019862		1 off
EZ 003072		1 off	I2 207169						Z 057091		
			I4 207432						Z 094258		
EZ 053083		1 off	I1 207102			IVS 076813		1 off	Z 029354		
EZ 003075		1 off	I2 207178						Z 064210		
			I4 207220						Z 093082		
EZ 057829		1 off	I1 207123			IVS 079186		1 off	Z 036473		
EZ 003080		1 off	I2 207183						Z 071329		
			I4 207223						Z 092383		
			I5 207266						Z 096464		
EZ 062575		1 off	I1 207136								
EZ 003079		1 off	I2 207191						Z 043592		
			I4 207230						Z 078448		
			I5 207270						Z 092109		
EZ 072069		1 off	I1 207138			IVS 043594		1 off	Z 048347		
EZ 001014		1 off	I2 207193						Z 004886		
			I4 207232						Z 092081		
			I5 207433						Z 095984		
EZ 215223		1 off	I2 215224						Z 215225		
			I4 207237						Z 207431		
			I5 207214						Z 207419		

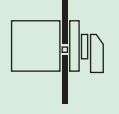

Moeller HPL0211-2004/2005

Contact sequence	Front plate no.	No. of poles	Max. three-phase motor rating AC-23A 400/415 V 50-60 Hz	Rated uninterrupted current	Basic type, insert mounting form identifier	Flush mounting Front IP65 	Std. pack
		B	P kW	I _u A		Mounting form type Article no.	Price See Price List

Changeover switches with 0 (Off) position,

With black thumb-grip and front plate

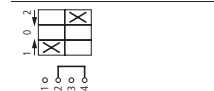

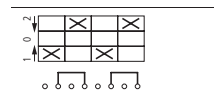
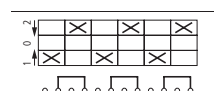

With spring-return from both directions to 0

		1	6.5	20	T0-1-8214/...	E 019863	1 off
		1	13	32	T3-1-8214/...	E 009632	
		2	6.5	20	T0-2-8215/...	E 022236	
		2	13	32	T3-2-8215/...	E 016751	
		3	6.5	20	T0-3-8216/...	E 024609	
		3	13	32	T3-3-8216/...	E 023870	

Changeover switches without 0 (Off) position,

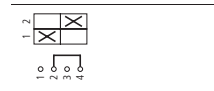
With black thumb-grip and front plate

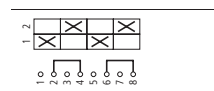
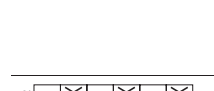
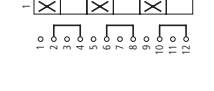
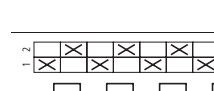
Changeover switches

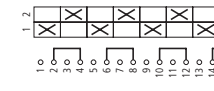
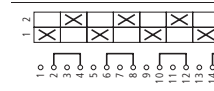
		1	6.5	20	T0-1-8220/...	E 031728	1 off
		1	13	32	T3-1-8220/...	E 038108	
		2	6.5	20	T0-2-8221/...	E 038847	
		2	13	32	T3-2-8221/...	E 045227	
		2	22	63	T5B-2-8221/...	E 093047	
		3	6.5	20	T0-3-8222/...	E 048339	
		3	13	32	T3-3-8222/...	E 052346	
		3	22	63	T5B-3-8222/...	E 092378	
		4	6.5	20	T0-4-8223/...	E 050712	
		4	13	32	T3-4-8223/...	E 059465	
		4	22	63	T5B-4-8223/...	E 092108	
		5	6.5	20	T0-5-8369/...	E 060204	
		5	13	32	T3-5-8369/...	E 066584	
		6	6.5	20	T0-6-8370/...	E 062577	
		6	13	32	T3-6-8370/...	E 073703	
		8	6.5	20	T0-8-8372/...	E 064950	
		8	13	32	T3-8-8372/...	E 080822	



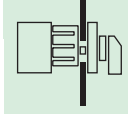
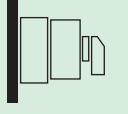
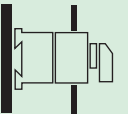
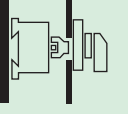





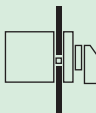
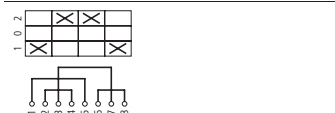

Moeller HPL0211-2004/2005

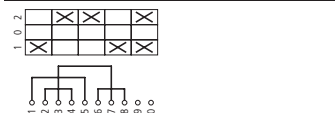
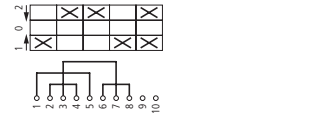
Centre mounting Front IP65 	Surface mounting IP65 	Service distribution board mounting Front IP 30 	Rear mounting Front IP65 					
Mounting form type Article no.	Price See Price List	Std. pack	Mounting form type Article no.	Price See Price List	Std. pack	Mounting form type Article no.	Price See Price List	Std. pack

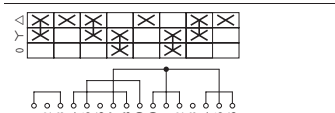
EZ 076815		1 off	I1 207077		1 off	IVS 045967		1 off	Z 050720		1 off
EZ 001073			I2 207170						Z 012005		
EZ 081561			I1 207103			IVS 048340		1 off	Z 053093		
EZ 001074			I2 207179						Z 019124		
EZ 086307			I1 207434			IVS 050713		1 off	Z 055466		
EZ 001077			I2 207184						Z 026243		

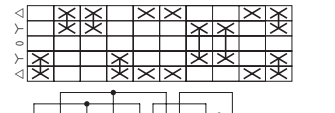
EZ 095799		1 off	I1 207078		1 off	IVS 055459		1 off	Z 086312		1 off
EZ 001018			I2 207171						Z 040481		
EZ 010372			I1 207104			IVS 057832		1 off	Z 074450		
EZ 001025			I2 207180						Z 047600		
			I4 207221						Z 093044		
EZ 015118		1 off	I1 207124			IVS 060205		1 off	Z 088686		
EZ 001069		1 off	I2 207185						Z 057092		
			I4 207224						Z 092375		
EZ 019864		1 off	I1 207137			IVS 062578		1 off	Z 086315		
EZ 001070		1 off	I2 207192						Z 061838		
			I4 207231						Z 092105		
EZ 024610		1 off				IVS 064951		1 off	Z 098180		
EZ 004503			I2 207536		1 off				Z 068957		
EZ 029356						IVS 067324		1 off	Z 010380		
EZ 004506									Z 078449		
EZ 034102						IVS 069697		1 off	Z 012753		
EZ 004508									Z 083195		

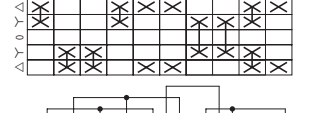



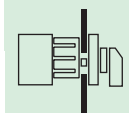
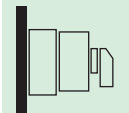
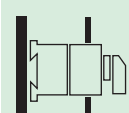
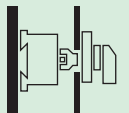

Moeller HPL0211-2004/2005

Contact sequence	Front plate no.	No. of poles	Max. three-phase-motor rating	Rated uninterrupted current		Flush mounting Front IP65			
			AC-23A 400/415 V 50-60 Hz						
		M	P kW	I _u A	Basic type, insert mounting form identifier	Mounting form type Article no.	Price See Price List	Std. pack	
Reversing switches with 0 (Off) position									
With black thumb-grip and front plate									
Without spring-return									
		2	6.5	20	T0-2-8400/...	E 053079		1 off	
			13	32	T3-2-8400/...	E 073695			
			22	63	T5B-2-8400/...	E 092918			
		3	6.5	20	T0-3-8401/...	E 091047			
			13	32	T3-3-8401/...	E 030992			
			22	63	T5B-3-8401/...	E 092296			
With spring-return from both directions to 0									
		3	6.5	20	T0-3-8228/...	E 015112		1 off	
			13	32	T3-3-8228/...	E 002538			
			22	63	T5B-3-8228/...	E 092374			
Star-delta switches									
With black thumb-grip and front plate									
		3	6.5	20	T0-4-8410/...	E 024604		1 off	
			13	32	T3-4-8410/...	E 009657			
			22	63	T5B-4-8410/...	E 092052			
Reversing star-delta switches									
With black thumb-grip and front plate									
Two-way switches									
		3	6.5	20	T0-5-15876/...	E 000893		1 off	
			13	32	T3-5-15876/...	E 016776			
			22	63	T5B-5-15876/...	E 214785			

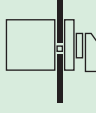
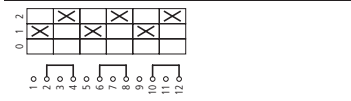
Moeller HPL0211-2004/2005

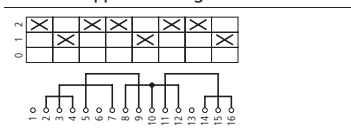
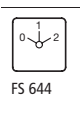
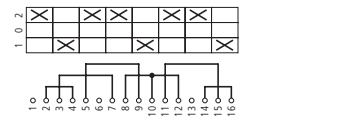
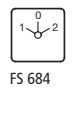
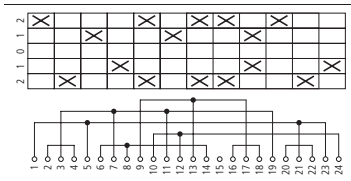
Centre mounting Front IP65			Surface mounting IP65			Service distribution board mounting Front IP 30			Rear mounting Front IP65		
											
Mounting form type Article no.	Price See Price List	Std. pack	Mounting form type Article no.	Price See Price List	Std. pack	Mounting form type Article no.	Price See Price List	Std. pack	Mounting form type Article no.	Price See Price List	Std. pack
EZ 055452		1 off	I1 207111		1 off	IVS 060198		1 off	Z 062571		1 off
EZ 000687		1 off	I2 207181						Z 095060		
			I4 207222						Z 092915		
EZ 093420		1 off	I1 207132			IVS 098166		1 off	Z 010366		
EZ 000694		1 off	I2 207188						Z 035739		
			I4 207227						Z 092293		
EZ 048334		1 off	I1 207125		1 off	IVS 062572		1 off	Z 074437		1 off
EZ 000695		1 off	I2 207186						Z 004911		
			I4 207225						Z 092371		
EZ 053080		1 off	I1 207140		1 off	IVS 064945		1 off	Z 083929		1 off
EZ 000721		1 off	I2 207195						Z 012030		
			I4 207234						Z 092049		
EZ 000900		1 off				IVS 000902		1 off	Z 000942		1 off
EZ 000797		1 off	I2 207537		1 off				Z 019149		
									Z 214786		

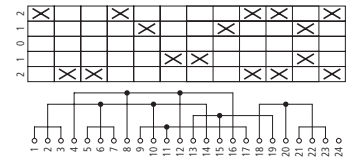
Moeller HPL0211-2004/2005

Contact sequence	Front plate no.	No. of poles	Max. three-phase-motor rating	Rated uninterrupted current		Flush mounting Front IP65			
			AC-23A 400/415 V 50-60 Hz						
		M	P kW	I _u A	Basic type, insert mounting form identifier	Mounting form type Article no.	Price See Price List	Std. pack	
Multi-speed switches									
With black thumb-grip and front plate									
Two-speed, non reversing, for two separate windings									
		3	6.5	20	T0-3-8451/...	E 038849		1 off	
			13	32	T3-3-8451/...	E 028641			
			22	63	T5B-3-8451/...	E 092288			
For one tapped winding									
		3	6.5	20	T0-4-8440/...	E 041222		1 off	
			13	32	T3-4-8440/...	E 035760			
			22	63	T5B-4-8440/...	E 092032			
			6.5	20	T0-4-8441/...	E 043595			
			13	32	T3-4-8441/...	E 042879			
			22	63	T5B-4-8441/...	E 092028			
Reversing multi-speed switches									
With black thumb-grip and front plate									
Two-speed, two directions, for one tapped winding									
		3	6.5	20	T0-6-15866/...	E 055460		1 off	
			13	32	T3-6-15866/...	E 054744			
			22	63	T5B-7-15866/...	E 214788			

Moeller HPL0211-2004/2005

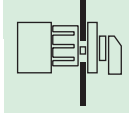
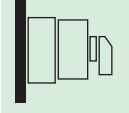
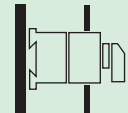
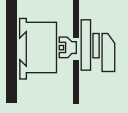
Centre mounting Front IP65			Surface mounting IP65			Service distribution board mounting Front IP 30			Rear mounting Front IP65		
											
Mounting form type Article no.	Price See Price List	Std. pack	Mounting form type Article no.	Price See Price List	Std. pack	Mounting form type Article no.	Price See Price List	Std. pack	Mounting form type Article no.	Price See Price List	Std. pack
EZ 083936		1 off	I1 207133		1 off	IVS 026985		1 off	Z 043596		1 off
EZ 000956		1 off	I2 207189						Z 031014		
			I4 207228						Z 092285		
EZ 088682		1 off	I1 207141		1 off	IVS 029358		1 off	Z 048342		1 off
EZ 000959		1 off	I2 207196						Z 038133		
			I4 207235						Z 092029		
EZ 093428		1 off	I1 207142			IVS 031731		1 off	Z 053088		
EZ 000960		1 off	I2 207197						Z 045252		
			I4 207236						Z 092025		
EZ 012747		1 off				IVS 036477		1 off	Z 067326		1 off
EZ 000964		1 off							Z 057117		
									Z 214789		

Moeller HPL0211-2004/2005

Moeller HPL0211-2004/2005

Contact sequence	Front plate no.	No. of poles	Flush mounting Front IP65		Centre mounting Front IP65	
			Basic type, insert mounting form identifier	Mounting form type Article no.	Price See Price List	Std. pack

Surface mounting IP65	Service distribution board mounting Front IP 30	Rear mounting Front IP65						
			Mounting form type Article no.	Price See Price List	Std. pack	Mounting form type Article no.	Price See Price List	Std. pack

Step switches

With black thumb-grip and front plate
One contact closed per step
(without overlap)

With additional 0 (Off) position

		1	T0-1-8240/...	E 034105		1 off	EZ 043597		1 off
			T0-2-8241/...	E 050716			EZ 053089		
			T0-2-8242/...	E 067327			EZ 069700		
			T0-3-8243/...	E 081565			EZ 083938		
			T0-3-8244/...	E 095803			EZ 098176		
		3	T0-3-8280/...	E 034106			EZ 036479		
			T0-5-8281/...	E 048344			EZ 050717		
			T0-6-8282/...	E 062582			EZ 064955		

I1 207079	1 off	IVS 027076	1 off	Z 060208	1 off
I1 207107		IVS 057835		Z 062581	
I1 207108		IVS 074446		Z 076819	
I1 207128		IVS 088684		Z 091057	
I1 207129		IVS 012749		Z 015122	
I1 207130		IVS 041225		Z 043598	
		IVS 055463		Z 057836	
		IVS 069701		Z 072074	

Moeller HPL0211-2004/2005

Moeller HPL0211-2004/2005

Contact sequence	Front plate no.	No. of poles	Flush mounting Front IP65		Centre mounting Front IP65		
			Mounting form type Article no.	Price See Price List	Std. pack	Mounting form type Article no.	Price See Price List

Surface mounting IP65	Service distribution board mounting Front IP 30	Rear mounting Front IP65			
			Mounting form type Article no.	Price See Price List	Std. pack

Step switches

With black thumb-grip and front plate
One contact closed per step
(without overlap)

Without 0 (Off) position

		1	T0-1-8220/...	E 031728	1 off	EZ 095799	1 off
		1	T0-2-8230/...	E 088685		EZ 091058	
		1	T0-2-8231/...	E 012750		EZ 015123	
		1	T0-3-8232/...	E 026988		EZ 029361	
		1	T0-3-8233/...	E 041226		EZ 043599	
		2	T0-4-8251/...	E 013971		EZ 013972	
		3	T0-3-8222/...	E 048339		EZ 015118	
		3	T0-5-8270/...	E 091059		EZ 093432	
		3	T0-6-8271/...	E 015124		EZ 017497	

I1 207078	1 off	IVS 055459	1 off	Z 086312	1 off
I1 207105		IVS 095804		Z 098177	
I1 207106		IVS 019869		Z 022242	
I1 207126		IVS 034107		Z 036480	
I1 207127		IVS 048345		Z 050718	
I1 218984		IVS 013974		Z 013976	
I1 207124		IVS 060205		Z 088686	
		IVS 098178		Z 010378	
		IVS 022243		Z 024616	

On-Off switches

With black thumb-grip and front plate

		1	T0-1-15401/...	E 038854	1 off	EZ 041227	1 off
		2	T0-1-15402/...	E 053092		EZ 055465	
		3	T0-2-15403/...	E 067330		EZ 069703	
		4	T0-2-15404/...	E 081568		EZ 083941	

I1 207067	1 off	IVS 045973	1 off	Z 048346	1 off
I1 207068		IVS 060211		Z 062584	
I1 207088		IVS 074449		Z 076822	
I1 207089		IVS 088687		Z 091060	

Moeller HPL0211-2004/2005

Moeller HPL0211-2004/2005

Contact sequence	Front plate no.	No. of poles	Flush mounting Front IP65			Centre mounting Front IP65		
			Basic type, insert mounting form identifier	Mounting form type Article no.	Price See Price List	Std. pack	Mounting form type Article no.	Price See Price List
Changeover switches								
With black thumb-grip and front plate								
		1	T0-1-15421/...	E 095806		1 off	EZ 098179	1 off
	FS 429	2	T0-2-15422/...	E 019871			EZ 022244	
		3	T0-3-15423/...	E 034109			EZ 036482	
Hand/Auto switches								
Front IP65								
With 0 (Off) position								
		1	T0-1-15431/...	E 019872		1 off	EZ 022245	1 off
	FS 1401	2	T0-2-15432/...	E 034110			EZ 036483	
		3	T0-3-15433/...	E 048348			EZ 050721	
With spring-return from HAND								
		1	T0-1-15434/...	E 062586		1 off	EZ 018053	1 off
	FS 1414000	2	T0-2-15435/...	E 003191		1 off	EZ 003192	1 off
With spring-return from START								
		1	T0-2-15907/...	E 066931		1 off	EZ 069304	1 off
	FS 1413890							
Without 0 (Off) position								
		1	T0-1-15451/...	E 076824		1 off	EZ 079197	1 off
	FS 19334	2	T0-2-15452/...	E 091062			EZ 093435	
		3	T0-3-15453/...	E 015127			EZ 017500	

Surface mounting IP65	Service distribution board mounting Front IP 30	Rear mounting Front IP65	Surface mounting IP65			Service distribution board mounting Front IP 30			Rear mounting Front IP65		
			Mounting form type Article no.	Price See Price List	Std. pack	Mounting form type Article no.	Price See Price List	Std. pack	Mounting form type Article no.	Price See Price List	Std. pack
			I1 207069		1 off	IVS 012752		1 off	Z 015125		1 off
			I1 207090			IVS 026990			Z 029363		
			I1 207114			IVS 041228			Z 043601		
			I1 207070		1 off	IVS 026991		1 off	Z 029364		1 off
			I1 207091			IVS 041229			Z 043602		
			I1 207115			IVS 055467			Z 057840		
			I1 207071		1 off	IVS 069705		1 off	Z 072078		1 off
			I1 218971		1 off	IVS 003195		1 off	Z 003196		1 off
			I1 207095		1 off	IVS 076423		1 off	Z 078796		1 off
			I1 207072		1 off	IVS 083943		1 off	Z 086316		1 off
			I1 207092			IVS 098181			Z 010381		
			I1 207116			IVS 022246			Z 024619		

Moeller HPL0211-2004/2005

Moeller HPL0211-2004/2005

Contact sequence	Front plate no.	No. of poles	Flush mounting Front IP65			Centre mounting Front IP65		
			Basic type, insert mounting form identifier	Mounting form type Article no.	Price See Price List	Std. pack	Mounting form type Article no.	Price See Price List
On switches (make contact) With black thumb-grip and front plate Spring-return from position 1								
		1	T0-1-15321/...	E 086317		1 off	EZ 088690	1 off
	FS 4721	2	T0-1-15322/...	E 010382			EZ 012755	
		3	T0-2-15323/...	E 024620			EZ 026993	
On-Off switches With black thumb-grip and front plate Spring-return from positions 0 and 1								
		1	T0-1-15366/...	E 081572		1 off	EZ 083945	1 off
On-Off switches With black thumb-grip and front plate Spring-return from position START								
		1	T0-1-15511/...	E 019875		1 off	EZ 022248	1 off
		2	T0-2-15512/...	E 034113			EZ 036486	
		3	T0-3-15513/...	E 048351			EZ 050724	
		see K 115	T0-2-8177/...	E 015130			EZ 017503	

Surface mounting IP65		Service distribution board mounting Front IP 30		Rear mounting Front IP65	
Mounting form type Article no.	Price See Price List	Std. pack	Mounting form type Article no.	Price See Price List	Std. pack
I1 207064		1 off	IVS 093436		1 off
I1 207065			IVS 017501		
I1 207087			IVS 031739		
I1 207066		1 off	IVS 088691		1 off
I1 207073		1 off	IVS 026994		1 off
I1 207093			IVS 041232		
I1 207117			IVS 055470		
I1 207101			IVS 022249		
			Z 095809		1 off
			Z 019874		
			Z 034112		
			Z 091064		1 off
			Z 029367		1 off
			Z 043605		
			Z 057843		
			Z 024622		

Rotary Switches, Switch-Disconnectors

Moeller HPL0211-2004/2005

Contact sequence	Front plate no.	No. of poles	Basic type, insert mounting form identifier	Mounting form type Article no.	Price See Price List	Std. pack	Centre mounting Front IP65 Mounting form type Article no.	Price See Price List	Std. pack
Universal control switches									
With black thumb-grip and front plate									
Stay-put switches with 3 positions 1 contact closed in each position In addition, 1 contact closed in positions 0 and 1 In addition, 1 contact closed in positions 0 and 2 In addition, 1 contact closed in positions 1 and 2									
		-	T0-3-15391/...	E 029365		1 off	EZ 031738		1 off
Spring-return from positions 1 and 2 With black thumb-grip and front plate									
		-	T0-3-15394/...	E 072079		1 off	EZ 074452		1 off
Coding switches									
With black thumb-grip and front plate With complete rotation in both directions									
		Dual BCD code	T0-4-15602/...	E 029368		1 off	EZ 031741		1 off
Series switches									
With black thumb-grip and front plate With 0 (Off) position (heater switches)									
		1	T0-1-91/...	E 072082		1 off	EZ 074455		1 off

Moeller HPL0211-2004/2005

Surface mounting IP65	Service distribution board mounting Front IP 30	Rear mounting Front IP65						
Mounting form type Article no.	Price See Price List	Std. pack	Mounting form type Article no.	Price See Price List	Std. pack	Mounting form type Article no.	Price See Price List	Std. pack
Surface mounting IP65								
IP65								
I1 207112		1 off	IVS 036484		1 off	Z 038857		1 off
Service distribution board mounting Front IP 30								
I1 207113		1 off	IVS 079198		1 off	Z 081571		1 off
Rear mounting Front IP65								
I1 207134		1 off	IVS 036487		1 off	Z 038860		1 off
I1 207080		1 off	IVS 079201		1 off	Z 081574		1 off

Rotary Switches, Switch-Disconnectors

Moeller HPL0211-2004/2005

Moeller HPL0211-2004/2005

Contact sequence	Front plate no.	No. of poles	Basic type, insert mounting form identifier	Flush mounting Front IP65			Centre mounting Front IP65		
				Mounting form type Article no.	Price See Price List	Std. pack	Mounting form type Article no.	Price See Price List	Std. pack
Voltmeter selector switches									
With black thumb-grip and front plate									
		3 × phase to phase with 0 (Off) position	T0-2-15920/...	E 038861		1 off	EZ 041234		1 off
		3 × phase to phase without 0 (Off) position	T0-2-15922/...	E 053099			EZ 055472		
		3 × phase to N with 0 (Off) position	T0-2-15921/...	E 067337			EZ 069710		
		3 × phase to phase + 3 × phase to N with 0 (Off) position	T0-3-8007/...	E 095813			EZ 098186		
		3 × phase to phase + 3 × phase to N without 0 (Off) position With complete rotation in both directions	T0-3-15924/...	E 019878			EZ 022251		
Ammeter selector switches									
With black thumb-grip and front plate With complete rotation in both directions Measurement via current transformers									
		With 0 (Off) position	T0-3-8048/...	E 034116		1 off	EZ 036489		1 off
Voltmeter and ammeter selector switches									
With black thumb-grip and front plate With complete rotation in both directions Measurement via current transformers (For other circuits → catalogue K115)									
		With 0 (Off) position	T0-3-8030/...	E 013401		1 off	EZ 013402		1 off

Mounting form type Article no.	Price See Price List	Std. pack	Service distribution board mounting Front IP 30			Rear mounting Front IP65		
			Mounting form type Article no.	Price See Price List	Std. pack	Mounting form type Article no.	Price See Price List	Std. pack
Surface mounting IP65								
I1 207098		1 off	IVS 029452		1 off	Z 048353		1 off
I1 207100			IVS 060218			Z 062591		
I1 207099			IVS 074456			Z 076829		
I1 207120			IVS 012759			Z 015132		
I1 207119			IVS 026997			Z 029370		
Surface mounting IP65								
I1 207122		1 off	IVS 041235		1 off	Z 043608		1 off
Surface mounting IP65								
I1 207121		1 off	IVS 013404		1 off	Z 013406		1 off

Rotary Switches, Switch-Disconnectors

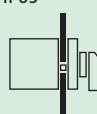

Rotary Switches, Switch-Disconnectors

Moeller HPL0211-2004/2005

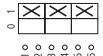

Contact sequence	Front plate no.	No. of poles	Max. three-phase motor rating AC-23A 400/415 V 50-60 Hz	Rated uninter- rupted current	Flush mounting IP65 	Type Article no.	Price See Price List	Std. pack
			P	I_u				
			kW	A				

Switches with locking arrangements, KMS1 lock mechanism

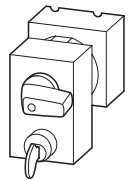

Panic switches with Emergency-Stop function, with SVA cylinder lock
Key withdrawable in positions 0 and 1.
When the key is withdrawn in position 1, the switch can still be switched Off,
but cannot be switched back On again without the key.

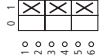
		3	6.5	20		T0-2-1/E/SVA(S) 050977		1 off
		3	13	25		P1-25/E/SVA(S) 050966		
		3	15	32		P1-32/E/SVA(S) 044977		
		3	13	32		T3-2-1/E/SVA(S) 050983		

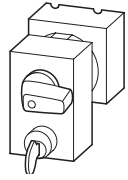

On-Off switch without Emergency-Stop function, with SVA cylinder lock
With black thumb-grip and front plate
Key withdrawable in position 0 only (Pos. A)

		3	6.5	20		T0-2-1/E/SVA(A) 050976		1 off
		3	13	25		P1-25/E/SVA(A) 050965		
		3	15	32		P1-32/E/SVA(A) 050970		
		3	13	32		T3-2-1/E/SVA(A) 050982		

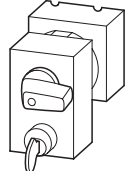

Panic switches with Emergency-Stop function, with SVA cylinder lock
To IEC/EN 60 204-1, VDE 0113 Part 1: with red thumb-grip and yellow front plate
Key withdrawable in positions 0 and 1.
When the key is withdrawn in position 1, the switch can still be switched Off,
but cannot be switched back On again without the key.

		3	6.5	20		T0-2-1/E/SVA(S)-RT 228291		1 off
		3	13	25		P1-25/E/SVA(S)-RT 050967		
		3	15	32		P1-32/E/SVA(S)-RT 050971		
		3	13	32		T3-2-1/E/SVA(S)-RT 044972		

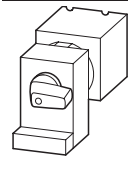
Panic switches with Emergency-Stop function, with SVC padlocking facility
To IEC/EN 60 204-1, VDE 0113 Part 1: with red thumb-grip and yellow front plate
Locking slide can be padlocked in positions 0 and 1.
When the locking slide is padlocked in position 1, the switch can still be switched Off,
but cannot be switched back On again without first removing the padlock.
Lockable using up to 3 padlocks.

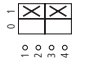

		3	6.5	20		T0-2-1/E/SVC(S)-RT 044973		1 off
		3	13	25		P1-25/E/SVC(S)-RT 044974		
		3	15	32		P1-32/E/SVC(S)-RT 044975		
		3	13	32		T3-2-1/E/SVC(S)-RT 044976		

On-Off switch without Emergency-Stop function, with S-T0 key operation, IP53
With black thumb-grip and front plate
Key withdrawable in position 0 only (Pos. A)

		2	6.5	20		T0-1-102/EZ/S 014933		1 off
---	---	---	-----	----	---	-------------------------	--	-------

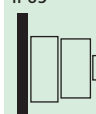
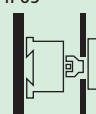
Moeller HPL0211-2004/2005

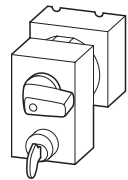
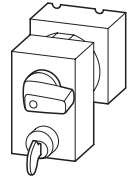
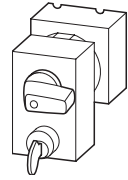
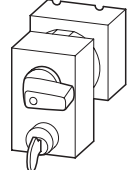
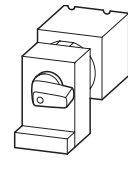
Surface mounting IP65 	Rear mounting IP65 					
Type Article no.	Price See Price List	Std. pack	Type Article no.	Price See Price List	Std. pack	Notes

	T0-2-1/I1/SVA(S) 207084	1 off				
	P1-25/I2/SVA(S) 207305					
	P1-32/I2/SVA(S) 207326					
	T3-2-1/I2/SVA(S) 207173					
	T0-2-1/I1/SVA(A) 207083	1 off		T0-2-1/Z/SVA(A) 050978	1 off	
	P1-25/I2/SVA(A) 207304			P1-25/Z/SVA(A) 050969		
	P1-32/I2/SVA(A) 207325			P1-32/Z/SVA(A) 050973		
	T3-2-1/I2/SVA(A) 207172			T3-2-1/Z/SVA(A) 050984		
	T0-2-1/I1/SVA(S)-RT 207085	1 off				
	P1-25/I2/SVA(S)-RT 207306					
	P1-32/I2/SVA(S)-RT 207327					
	T3-2-1/I2/SVA(S)-RT 207174					
	T0-2-1/I1/SVC(S)-RT 207086	1 off				
	P1-25/I2/SVC(S)-RT 207307					
	P1-32/I2/SVC(S)-RT 207328					
	T3-2-1/I2/SVC(S)-RT 207175					
	T0-1-102/I1/S 207063	1 off		T0-1-102/Z/S 014971	1 off	

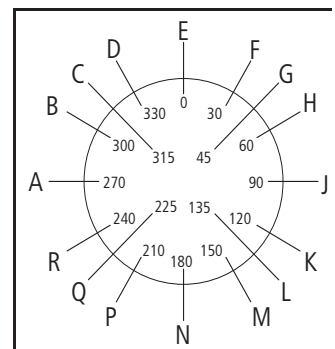

Code letters for lockable switch positions
Letter S for panic lock with FS908GE

Rotary Switches, Switch-Disconnectors

Rotary Switches, Switch-Disconnectors

Moeller HPL0211-2004/2005

Moeller HPL0211-2004/2005

Switch size	Dimensions (W × H × D) mm	Standard front plates Can be laser inscribed			Emergency-Stop front plates		
		Type Article no.	Price See Price List	Std. pack	Type Article no.	Price See Price List	Std. pack
Front plates							
P3, T5, T5B	84 × 84 (for frame size 88 × 88)	FS(*)-P3 231895		10 off	FS908GE-P3 031475		5 off
T0, T3, P1	45 × 45 (for frame size 48 × 48)	FS(*)-T0 231893		10 off	FS908GE-T0 003198		5 off
TM	29 × 29 (for frame size 30 × 30)						
TM	29 × 29 (for frame size 30 × 30)						

Switch size	Dimensions (W × H × D) mm	Blank plates Can be engraved			Non-standard front plates		
		Type Article no.	Price See Price List	Std. pack	Type Article no.	Price See Price List	Std. pack
		FS-ALU980-P3 266906		10 off	FS-SOND-ERSTBESTELLUNG-P3 225356		1 off
		FS-ALU980-T0 266905		50 off	FS-SOND-ERSTBESTELLUNG-T0 225355		1 off
		FS980-TM-EZ 073811		50 off	TM/EZ-FRONTSCCHILD-NR(*) 239022		5 off
		FS980-TM-E 071438		10 off	TM/E-FRONTSCCHILD-NR(*) 239021		5 off

Standard front plates

The standard front plates illustrated should be used for non-standard switches where possible. Standard catalogue front plates for standard switches can be exchanged on request with order, for those illustrated here, at no extra charge (not applicable to T6, T8 and TM), provided the switching angles, the number of switch positions, and the location of the 0 (Off) position match.

Switching angle 90°

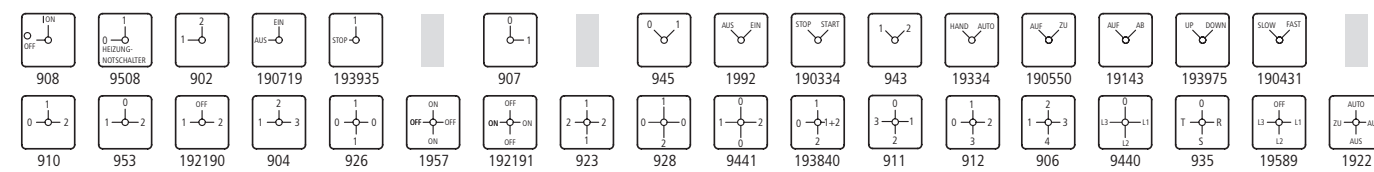

Switching angle 60°

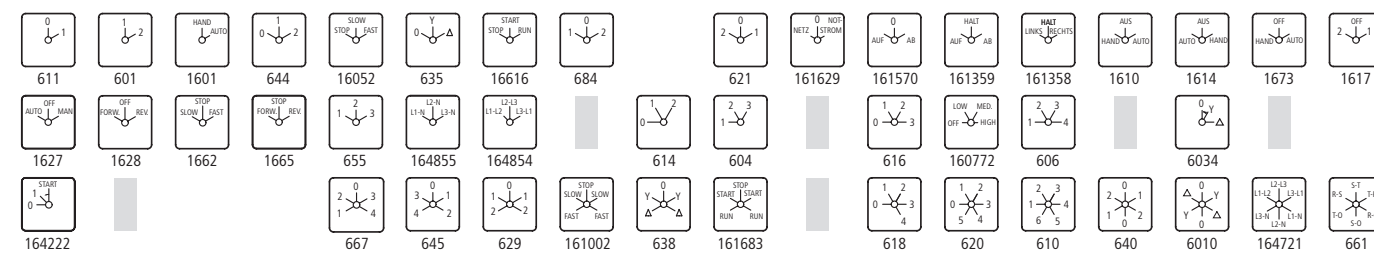

Switching angle 45°

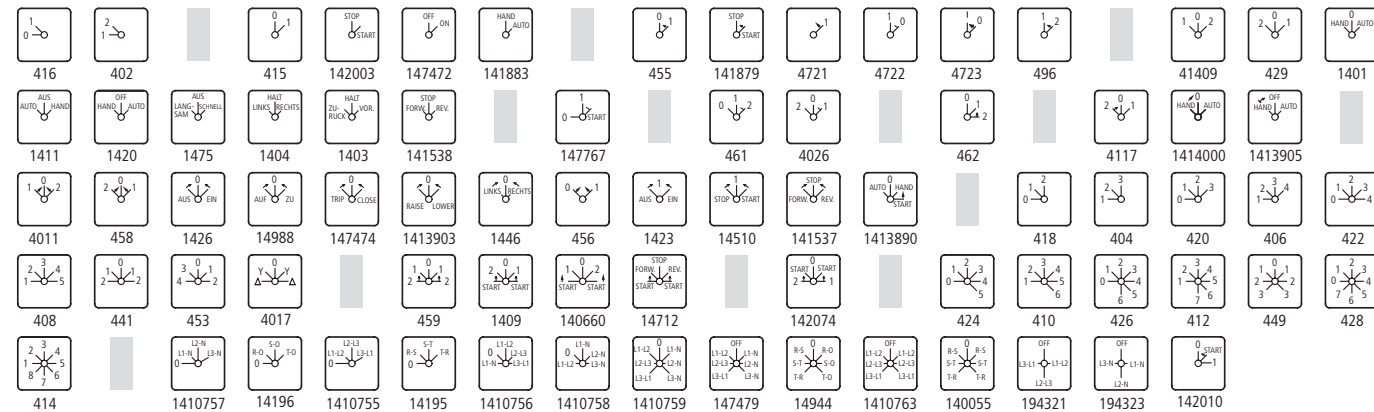

Switching angle 30°

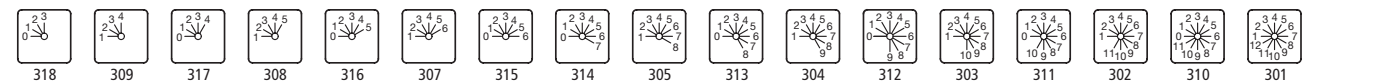

Non-standard front plates

Inscription to order (note maximum number of characters per field). First order via the "Ordering of Special Front Plates" form. The FS number is sufficient for reordering. For non-standard T0, T3 and T5(B), the front plate is included in the price. For subsequent orders use FS(*)-T0(P3)

Standard front plates arranged in their numerical sequence:

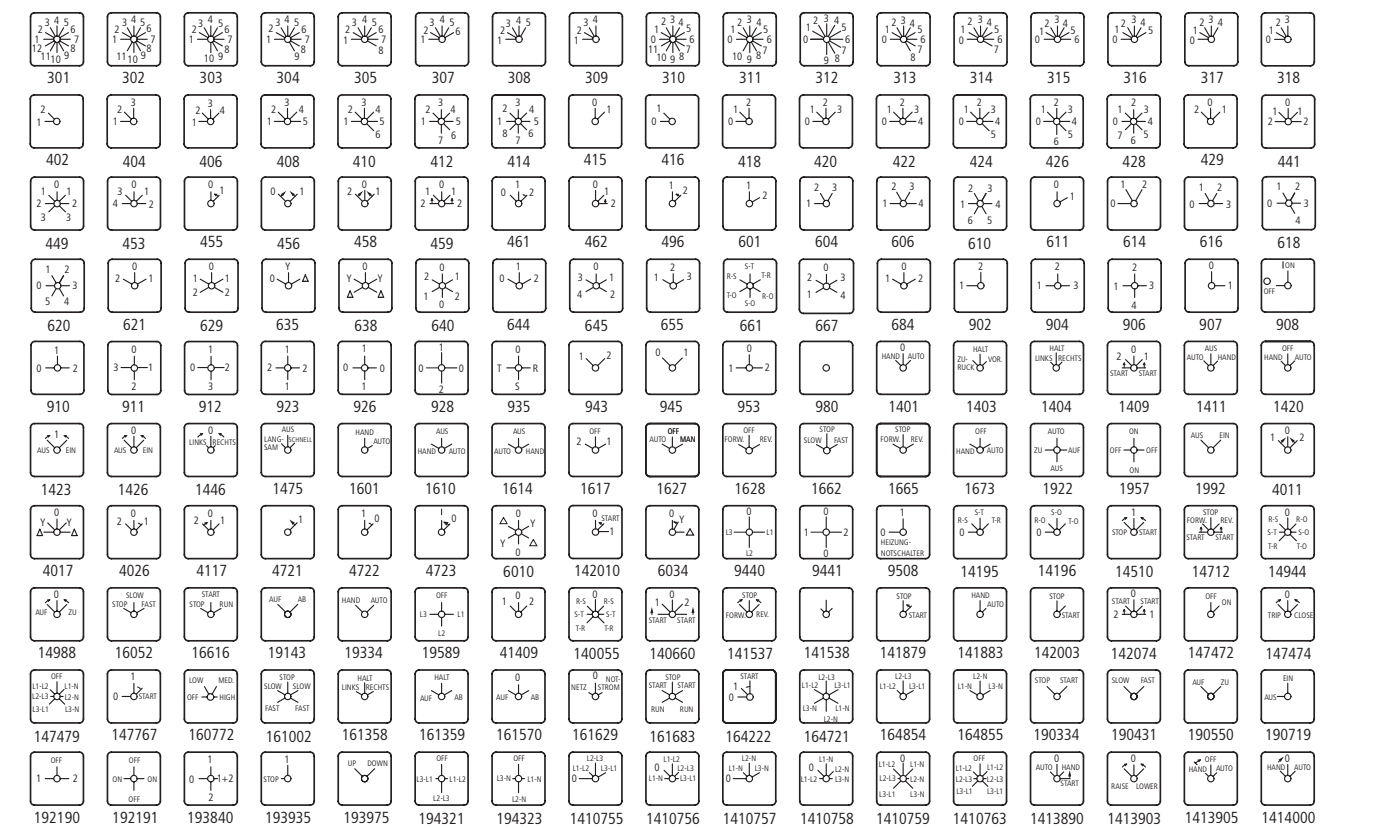

Moeller HPL0211-2004/2005

S-T0 key operation, Front IP53

With two keys

Key withdrawable in all positions

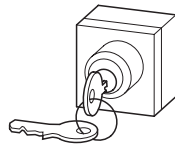

KMS1 lock mechanism: individual lock mechanism, not suitable for master key systems

KMS2 – 10 lock mechanisms, KMS201 – 400 lock mechanisms: individual lock mechanisms, not suitable for master key systems

T0-.../E, .../I1, .../Z up to 6 contact units
T3-.../E, .../I2, .../Z up to 5 contact units
P1-.../E, .../I2, .../Z

Key withdrawal positions can be programmed by user

Key can be withdrawn in positions as specified

KMS1 lock mechanism: switches with FS908 are suitable as main switches: T0-1-... to T0-4-.../I1, .../E;
T3-1-... to T3-5-.../I2; T3-1-... to T3-6-.../E; P1-.../I2, .../E

KMS2 – 10 lock mechanisms, KMS201 – 400 lock mechanisms: individual lock mechanisms, not suitable for master key systems

SA(...) = Master key system (with master key) supplied with a security certificate. Order must include a lock plan showing the full configuration of the envisaged lock system. For subsequent part orders, simply state the item number within the lock plan, e.g. (A6294-1/2).

T0-.../E, .../I1, .../Z up to 6 contact units
T3-.../E, .../I2, .../Z up to 5 contact units
P1-.../E, .../I2, .../Z

Key withdrawal positions are programmed ex-works as ordered

SVA-T3 cylinder lock, front IP65

With two keys

Key withdrawable in all positions



KMS1 lock mechanism: individual lock mechanism, not suitable for master key systems

KMS2 – 10 lock mechanisms, KMS201 – 400 lock mechanisms: individual lock mechanisms, not suitable for master key systems

T0-.../E, .../I1, .../Z
T3-.../E, .../I2, .../Z
P1-.../E, .../I2, .../Z

Key withdrawal positions can be programmed by user

Key can be withdrawn in positions as specified

KMS1 lock mechanism: switches with FS908 are suitable as main switches: T0-1-... to T0-4-.../I1, .../E;
T3-1-... to T3-5-.../I2; T3-1-... to T3-6-.../E; P1-.../I2, .../E

KMS2 – 10 lock mechanisms, KMS201 – 400 lock mechanisms: individual lock mechanisms, not suitable for master key systems

SA(...) = Master key system (with master key) supplied with a security certificate. Order must include a lock plan showing the full configuration of the envisaged lock system. For subsequent part orders, simply state the item number within the lock plan, e.g. (A6294-1/2).

T0-.../E, .../I1, .../Z
T3-.../E, .../I2, .../Z
P1-.../E, .../I2, .../Z

Key withdrawal positions are programmed ex-works as ordered

SVC-T3 padlocking feature, front IP65

In the depressed, locked position, the locking slide is lockable using up to 3 padlocks.

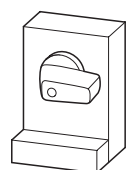

All positions are lockable

Specified positions or ranges are lockable

T0-.../E, .../I1, .../Z
T3-.../E, .../I2, .../Z
P1-.../E, .../I2, .../Z

Switches with FS908 can be used as main switches for:
T0-1-... to T0-4-.../I1, .../E
T3-1-... to T3-5-.../I2
T3-1-... to T3-6-.../E
P1-.../I2, .../E

Key withdrawal positions can be programmed by user

Key withdrawal positions are programmed ex-works as ordered

Moeller HPL0211-2004/2005

Type Article no.	Price	Std. pack	Notes
S-T0 086709		1 off	The key replaces the thumb-grip, switching is not possible without key. The switch position indicator is on the lock. In standard applications, the key can be withdrawn in any position. On rotary switches ordered with FS908 front plate and key operation (as + Type), the key is withdrawable in the 0 (Off) position only. New positions for key withdrawal can be selected (even retrospectively, by fitting VR-T0 locking cams. When retrofitting the S-T0 key operation, use the front plate of the switch. Keys → 7/52
S-SOND-KMS(*)-T0 231957		1 off	
S(*)-T0 231959		1 off	
S(*)-SOND-KMS(*)-T0 231961			
S(*)-SOND-SA(*)-T0 231965			
SVA-T3 050974		1 off	Switching is carried out using the thumb-grip. The switch is locked by turning the key; the key is withdrawable. In standard applications, all positions are lockable. When retrofitting the S-T0, use the front plate of the switch. Individual positions or ranges can be locked (also with VR-T3 fitted by the user). The key cannot be withdrawn in positions that are not lockable. When ranges are locked, switching without the key is possible only within a locked range. The lockable positions or ranges are shown; use the code letters to state your selection on the order: Example 1: SVA(A)-T3 = Only position A withdrawn Example 2: SVA(A, E)-T3 = Positions A and E withdrawn Example 3: SVA(A-J)-T3 = Range A to J withdrawn Example 4: SVA(S)-T3 = Main switches, for use as Emergency-Stop devices to IEC/EN 60204-1, VDE 0113 Part 1: with red thumb-grip and yellow front plate as panic lock version, lockable in positions A and E; switching is still possible from E to A, but not from A to E.
SVA-SOND-KMS(*)-T3 231967		1 off	
SVA(*)-T3 907745		1 off	
SVA(*)-SOND-KMS(*)-T3 231969			
SVA(*)-SOND-SA(*)-T3 231971			
SVC-T3 050975		1 off	Switching is carried out using the thumb-grip. Interlocking is carried out by depressing an actuator that can be locked in position by using up to 3 padlocks. In standard applications, all positions are lockable. With type reference SVC(...)T3, only the specified positions or ranges are lockable. When ranges are locked, switching is possible only within a locked range, unless the padlock is removed first. The lockable positions or ranges are shown below. Diagram → Notes for SVA(...)T3 When retrofitting the SVA-T3, use the front plate of the switch. With letter S for panic lock, use FS908GE.
SVC(*)-T3 907748		1 off	

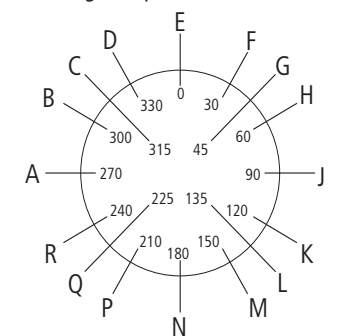

When retrofitting the SVA-T3, use the front plate of the switch. With letter S for panic lock, use FS908GE.
Ordering example: P1-25/I2-RT+SVA(S)-T3

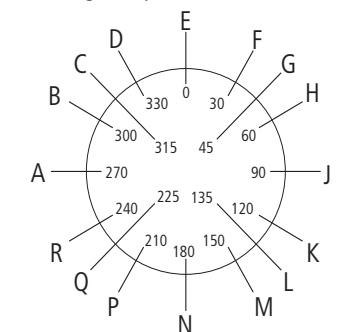

Letter S for panic lock with FS908GE
Ordering example:
SVA(A-G)-SOND-SA(A6294-1/2)-T3

Ordering example: P1-25/I2-RT+SVC(S)-T3

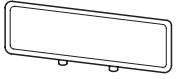

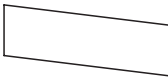





For use with	For T0, T3, P1 rotary switches			Std. pack	For T5(B), P3 switch-disconnectors		
	Type Article no.	Price			Type Article no.	Price	Std. pack
Add-on front plates, clip-on, complete							
For padlocking features, consisting of label mount and insert plate							
							
Engraved with standard text Main switch - "Open only in the Off position" Front plates supplied with: Main switches for flush mounting: T.../EA/SVB, P.../EA/SVB Main switches for rear mounting: T.../V/SVB, P.../V/SVB							
P3-.../E, .../Z, .../EA, .../V 61/62 = German /English	ZFS61/62-T0 030170			25 off	ZFS61/62-P3 065739		25 off
63 = French	ZFS63-T0 047424				ZFS63-P3 047423		
64 = Bulgarian	ZFS64-T0 205535				ZFS64-P3 205552		
65 = Danish	ZFS65-T0 205536				ZFS65-P3 205553		
66 = Finnish	ZFS66-T0 205537				ZFS66-P3 205554		
67 = Dutch	ZFS67-T0 065750				ZFS67-P3 065753		
68 = Italian	ZFS68-T0 065751				ZFS68-P3 065754		
69 = Greek	ZFS69-T0 205538				ZFS69-P3 205555		
70 = Norwegian	ZFS70-T0 205539				ZFS70-P3 205556		
71 = Polish	ZFS71-T0 205540				ZFS71-P3 205557		
72 = Portuguese	ZFS72-T0 205541				ZFS72-P3 205558		
73 = Romanian	ZFS73-T0 205542				ZFS73-P3 205559		
74 = Russian	ZFS74-T0 205543				ZFS74-P3 205560		
75 = Swedish	ZFS75-T0 205544				ZFS75-P3 205561		
76 = Serbo-Croat	ZFS76-T0 205545				ZFS76-P3 205562		
77 = Spanish	ZFS77-T0 065752				ZFS77-P3 047422		
78 = Czech	ZFS78-T0 205546				ZFS78-P3 205563		
79 = Turkish	ZFS79-T0 205547				ZFS79-P3 205564		
80 = Hungarian	ZFS80-T0 205548				ZFS80-P3 205565		
81 = Afrikaans	ZFS81-T0 205549				ZFS81-P3 205566		
Blank, can be engraved							
	ZFS60-T0 019924			25 off	ZFS60-P3 022297		25 off
Label mount black, clip-on							
							
	ZFSX-T0 024670			25 off	ZFSX-P3 027043		25 off
Insert plates							
							
	BS45X14-T0 029416			25 off	BS84X24-P3 031789		25 off



Main Switch Assembly Kits, Thumb-Grips, Maintenance Keys



Moeller HPL0211-2004/2005

	For use with	Type Article no.	Price	Std. pack	Notes
Main switch assembly kits					
Padlocking feature, exclusively for main switches Admissible on T0 up to 4 contact units Admissible on T3 up to 6 contact units					
	For use as Emergency-Stop devices to IEC/EN 60204-1, VDE 0113 Part 1, with red rotary handle and yellow locking collar	T0-.../E, .../Z, .../I1 T3-.../E, .../Z, .../I2 P1-.../E, .../Z, .../I2	SVB-T0 057892	1 off	<ul style="list-style-type: none"> For locking the Off position For switches with positions 0 – I at 90° Switching angle, as front plate: FS908 Lockable in the 0 (Off) position
		T5B-.../E, .../Z, .../I4 T5-.../E, .../Z, .../I5 P3-63/E, .../Z, .../I4 P3-100/E, .../Z, .../I5	SVB-P3 052999	1 off	
	Without Emergency-Stop function, black handle, black locking collar	T0-.../E, .../Z, .../I1 T3-.../E, .../Z, .../I2 P1-.../E, .../Z, .../I2	SVB-SW-T0 060265	1 off	<ul style="list-style-type: none"> For locking the Off position For locking the On position if required Lockable using up to 3 padlocks Padlocks with KMS lock mechanisms can be obtained at C.E. Schulte (CES), Velbert, Type 219/38 (KMS...) or from local hardware stores
		T5B-.../E, .../Z, .../I4 T5-.../E, .../Z, .../I5 P3-63/E, .../Z, .../I4 P3-100/E, .../Z, .../I5	SVB-SW-P3 062491	1 off	
Main switch assembly kits with PE terminal and N terminal					
Padlocking feature, exclusively for main switches Admissible on T0 up to 4 contact units Admissible on T3 up to 6 contact units					
	For use as Emergency-Stop devices to IEC/EN 60204-1, VDE 0113 Part 1, with red rotary handle and yellow locking collar	T0-.../E, .../Z T3-.../E, .../Z	V/EA/SVB-T0 062638	1 off	<ul style="list-style-type: none"> For conversion of T.../E flush mounting switches (with front plate FS908) into T.../EA/SVB... flush mounting main switches For conversion of T.../Z rear mounting switches (with front plate FS908) into interlocked T.../V/SVB rear mounting main switches
		T5(B)-.../E, .../Z	V/EA/SVB-T5 045065	1 off	
	Without Emergency-Stop function, black handle, black locking collar	T0-.../E, .../Z T3-.../E, .../Z	V/EA/SVB-SW-T0 065011	1 off	–
		T5(B)-.../E, .../Z	V/EA/SVB-SW-T5 045064	1 off	–
Thumb-grips					
	Black	–	KNB-T0 038909	10 off	–
	Red, only for Emergency-Stop switches to IEC/EN 60204-1, VDE 0113 Part 1	–	KNB-RT-T0 043655	10 off	• Order additional yellow front plate FS908GE-T0
	Black	–	KNB-P3 041282	10 off	–
	Red, only for Emergency-Stop switches to IEC/EN 60204-1, VDE 0113 Part 1	–	KNB-RT-P3 046028	10 off	• Order additional yellow front plate FS908GE-T0
Maintenance key for interlocked main switches					
	For T0	–	KNK-T0 000650	5 off	Special devices for electricians, to allow them to switch interlocked main switches On and Off, when the panel door is open for maintenance purposes (to IEC/EN 60204-1, Clause 5.1.1.1)
	For P3	–	KNK-P3 000649	5 off	





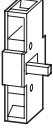

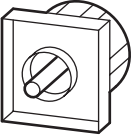
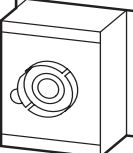
Neutral Poles, Auxiliary Switches, Centre Mounting Accessories, Distribution Board Mounting Kit

Moeller HPL0211-2004/2005

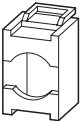

	For use with	Type Article no.	Price	Std. pack
Neutral conductor				
Early make and late break The neutral contact is always early make and late break. Switching capacity of N-P1(P3)... equivalent to P1(P3)-...				
	For side mounting, left or right	P1-.../E, .../EA, .../EZ	N-P1E 000651	5 off
	With P1-.../I2: N-P1Z or HI11-P1/P3Z can be fitted to left only	P1-.../Z, .../N, .../I2, .../IVS	N-P1Z 000652	
		P3-.../E, .../EA...	N-P3E 062432	
		P3-.../Z, .../N, .../IVS P3-63/E, .../Z, /I4 P3-100/E, .../Z, .../I5	N-P3Z 064805	
Neutral terminal				
	Front fitting, right-hand side Service distribution board mounting, left-hand side	P5-125(160)/E(EA)	N-P5-125/160E 280969	1 off
		P5-125(160)/Z(V)	N-P5-125/160Z 280970	
		P5-250(315)/E(EA)	N-P5-250/315E 280971	
		P5-250(315)/Z(V)	N-P5-250/315Z 280972	
Earth terminal				
	Front fitting, right-hand side Service distribution board mounting, left-hand side	P5-125(160)/E(EA)	PE-P5-125/160E 280973	1 off
		P5-125(160)/Z(V)	PE-P5-125/160Z 280974	
		P5-250(315)/E(EA)	PE-P5-250/315E 280975	
		P5-250(315)/Z(V)	PE-P5-250/315Z 280976	
Auxiliary contacts				
1 make contact, 1 break contact The neutral contact is always early make and late break. The make contact is always connected as a load-shedding contact.				
	For side mounting, left and/or right	P1-.../E, .../EA..., .../EZ P3-.../E, .../EA	HI11-P1/P3E 061813	5 off
	With P1-.../I2: HI11-P1/P3Z or N-P1Z can be fitted to left only	P1-.../Z, .../N, .../I2, .../IVS P3-63/Z, .../N, .../I4, .../IVS P3-100/Z, .../N, .../I5, .../IVS	HI11-P1/P3Z 062031	
2 make contacts 1 break contact				
	For side mounting, left or right	P5-125(160)/E(EA)	HI21-P5-125/160E 280963	1 off
		P5-125(160)/Z(V)	HI21-P5-125/160Z 280964	
		P5-250(315)/E(EA)	HI21-P5-250/315E 280965	
		P5-250(315)/Z(V)	HI21-P5-250/315Z 280966	
Centre mounting accessories				
For single-hole fitting Mounting diameter: 22.3 mm				
	For rotary switches with existing front plate Quick mounting by snap fixing	T0-.../E T3-.../E	EZ-T0 081622	1 off
	Mounting diameter 22.3 mm and 30.5 mm, Can be fitted by one operator by screw fixing	T0-.../E T3-.../E P1-.../E	EZ-P1 091455	5 off
Service distribution board mounting accessories				
Includes push-fit shaft				
	For retrofitting as T0-.../IVS service distribution board mounting. Use the front plate of the basic switch.	T0-.../XZ	IVS-T0 091114	1 off

Coupling Drives, Interlock Sections, Interlock/Shaft Extensions

Moeller HPL0211-2004/2005

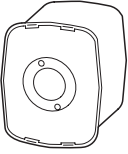
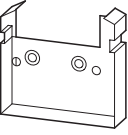
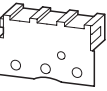
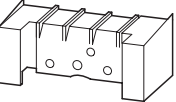
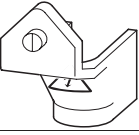
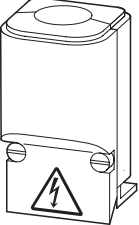

	For use with	Type suffix/Type Article no. when ordered with basic unit/when ordered separately	Price See Price List	Std. pack	Notes
Coupling drive					
Includes push-fit shaft					
	For retrofitting T0(T3)-.../XZ basic switches in rear mounting form Spare part for T0(T3)/(P1)-.../Z	–	DE-T0 093487	1 off	–
	For conversion of T5(B)-.../E flush mounting switches to rear mounting switches Spare part for T5(B)/(P3)-.../Z	–	DE-P3 093972	3 off	–
Interlock sections					
With PE- and N conductor connection Fits on the reverse of flush mounting switches, with interlocking function for rear mounting switches.					
	–	T0-.../E, ...EZ, ...Z T3-.../E, ...EZ, ...Z P1-.../E, ...EZ, ...Z	UV-T0 019925	1 off	Fits on the reverse of flush mounting switches
	–	T5(B)-.../E, ...Z P3-.../E, ...Z	UV-P3 048289		With interlocking function for rear mounting switches
Interlock extensions					
Up to four off, 25 mm each, can be plugged onto interlock section (an equal number of shaft extensions is required for this purpose)					
	Use ZVV-T0 only with T0/T3-.../Z and P1-.../Z	UV-T0	ZVV-T0 022298	10 off	Use ZVV-T0 only with T0/T3-.../Z and P1-.../Z
	Use ZVV-P3 only with T5(B)-.../Z and P3-.../Z	UV-P3	ZVV-P3 024671		Use ZVV-P3 only with T5(B)-.../Z and P3-.../Z
Shaft extensions					
Up to four off, 25 mm each, can be plugged onto switch shaft					
	–	T0-.../Z T3-.../Z P1-.../Z	ZAV-T0 027044	10 off	–
	–	T5(B)-.../Z P3-.../Z	ZAV-P3 029417		–
Shaft					
	Aluminium, length: 480 mm	P5-.../V... P5-.../Z	ZAV-P5 280979	1 off	–
Interlock extensions and shaft extensions, complete					
Can only be supplied in conjunction with a base unit					
	Extension up to 25 mm	–	+ZAV(X1)+ZVV(X1)-T0/P3 254546	1 off	–
	Extension up to 50 mm	–	+ZAV(X2)+ZVV(X2)-T0/P3 254547		–
	Extension up to 75 mm	–	+ZAV(X3)+ZVV(X3)-T0/P3 254548		–
	Extension up to 100 mm	–	+ZAV(X4)+ZVV(X4)-T0/P3 254549		–
Control circuit terminal					
	–	P5-125/160	ST-P5-125/160 280977	1 off	Terminal capacity • Solid or stranded: 4 mm ² • Flexible with ferrule to DIN 46228: 4 mm ²
	–	P5-250/315	ST-P5-250/315 280978		



	For use with	Type Article no.	Price	Std. pack	Notes
Shrouds					
	For flush mounting switches with up to 4 contact units	T0-.../E T3-.../E	H3-T0 093828	1 off	Cable entries Quantity: 2 × Ø 20 mm + 2 × Ø 15 mm Cross-section: 5 × 6 mm ² 5 × 2.5 mm ²
	To cover terminals of up to 2 contact units	T5(B)-.../E, .../Z	H1-T5 045062		Can be used for input and/or output wiring, as required
–	Extension for H1-T5 cover to protect 3 – 8 contact units	H1-T5	HZ-T5 045063	10 off	1 × HZ-T5 required per contact unit
	To cover terminals of 3-pole switch-disconnectors	P1-.../E, .../EZ, .../Z, .../EA, .../V	H-P1 017253	5 off	Can be used for input and/or output wiring, as required
–	To cover terminals of 4-pole switch-disconnectors	P1-...N, ...HI11, ...N...HI11	H-P14 019626		Can be used for input and/or output wiring, as required
	To cover terminals of 3-pole open switch-disconnectors with N neutral conductor and/or HI11 auxiliary contact fitted	P3-.../E, .../Z, .../EA, .../V P3-...N, ...HI11, ...N...HI11	H-P3 021999		The shroud is designed for fitting on both sides of the switch-disconnector; parts that are not required can be broken off.
	Set of six, to protect the terminals	T6-160-6/...	H-T6-160 200183	1 off	–
–	Set of three, to protect the terminals	P5	H-P5-125/160-3P 280967		–
–	Set of four, to protect the terminals	P5	H-P5-125/160-4P 280968		–
	Set of six, to protect the terminals	T8-3-8342/...	H-T8 200184		–
Keys					
	For KMS1 individual lock mechanism	–	ES-KMS1-T0 231972	1 off	–
	For KMS2 – 10 or KMS201 – 400 individual lock mechanism	–	ES-KMS(*)-T0 231973		–
	Individual key, stainless steel, for master key systems and recorded individual lock mechanisms, state lock plan number and lock.	–	HS-SA(*)-T0 256151		Master keys must always be ordered separately. Please send or submit the security certificate with repeat orders. Ordering example: HS-SA(A6294-1/2)-T0

Insulated Enclosures, Neutral Terminals, Set of Extension Terminals, Set of Locking Cams

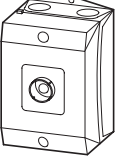
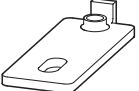
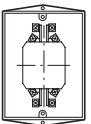
Moeller HPL0211-2004/2005

	For use with	Type Article no.	Price	Std. pack	Notes
Insulated enclosure, IP65, with stainless steel screws					
 <small>totally insulated</small>					
With one additional terminal					
1 – 2 contact units	T0-.../XZ	CI-K1-T0-2 207435		1 off	Cable sizes which can be pushed through the diaphragm Main current/control current: 12 mm/- 16 mm/8 mm 1 contact unit = 2 contacts
3 – 4 contact units	T0-.../XZ	CI-K1-T0-4 207436			
1 – 2 contact units	T3-.../XZ	CI-K2-T3-2 207437			
3 – 4 contact units	T3-.../XZ	CI-K2-T3-4 225325			
5 contact units	T3-.../Z	CI-K2-T3-5 207438			
1 – 2 contact units	T5B-.../E	CI-K4-T5B-2 207439			
3 – 4 contact units	T5B-.../Z	CI-K4-T5B-4 207440			
1 – 2 contact units	T5-.../Z	CI-K5-T5-2 207441			
3 – 4 contact units	T5-.../Z	CI-K5-T5-4 207442			
Neutral terminals					
For connection of a 5th conductor					
-	T0-.../I1, CI-K1-T0-... T3-.../I2, CI-K2-T3-... P1-.../I2	K-CI-K1/2 207451		20 off	-
-	T5B-.../I4, CI-K4-T5B-... P3-.../I4	K-CI-K4 206916		20 off	-
-	T5-.../I5, CI-K5-T5-... P3-.../I5	K-CI-K5 218488		1 off	-
Set of external fixing brackets					
	-	T5B-.../I4, T5-.../I5, P3-63/I4, P3-100/I5,	AB-CI-K4/5 206914	1 off	For fixing CI-K4 and CI-K5 directly to the wall. One set comprises 4 brackets.
Set of extension terminals					
For retrofitting For cable connection in the enclosure					
	For the lowermost contact unit	T5B-.../I4 T5-.../I5	AW-T5-1/2 032601	10 off	Included with T5B-.../I4 and T5-.../I5 as standard.
	For the second contact unit from the bottom	T5-.../I5	AW-T5-3/4 032602	1 off	
Set of locking cams, consisting of 2 locking cams					
	For retrospectively changing the indexing positions in which the key can be withdrawn	S-T0 for all switching angles	VR-T0 089082	1 off	-
	For changing the locked positions/ranges	SVA-T3 SVC-T3	VR-T3 050987	1 off	-



TM On-Off switches

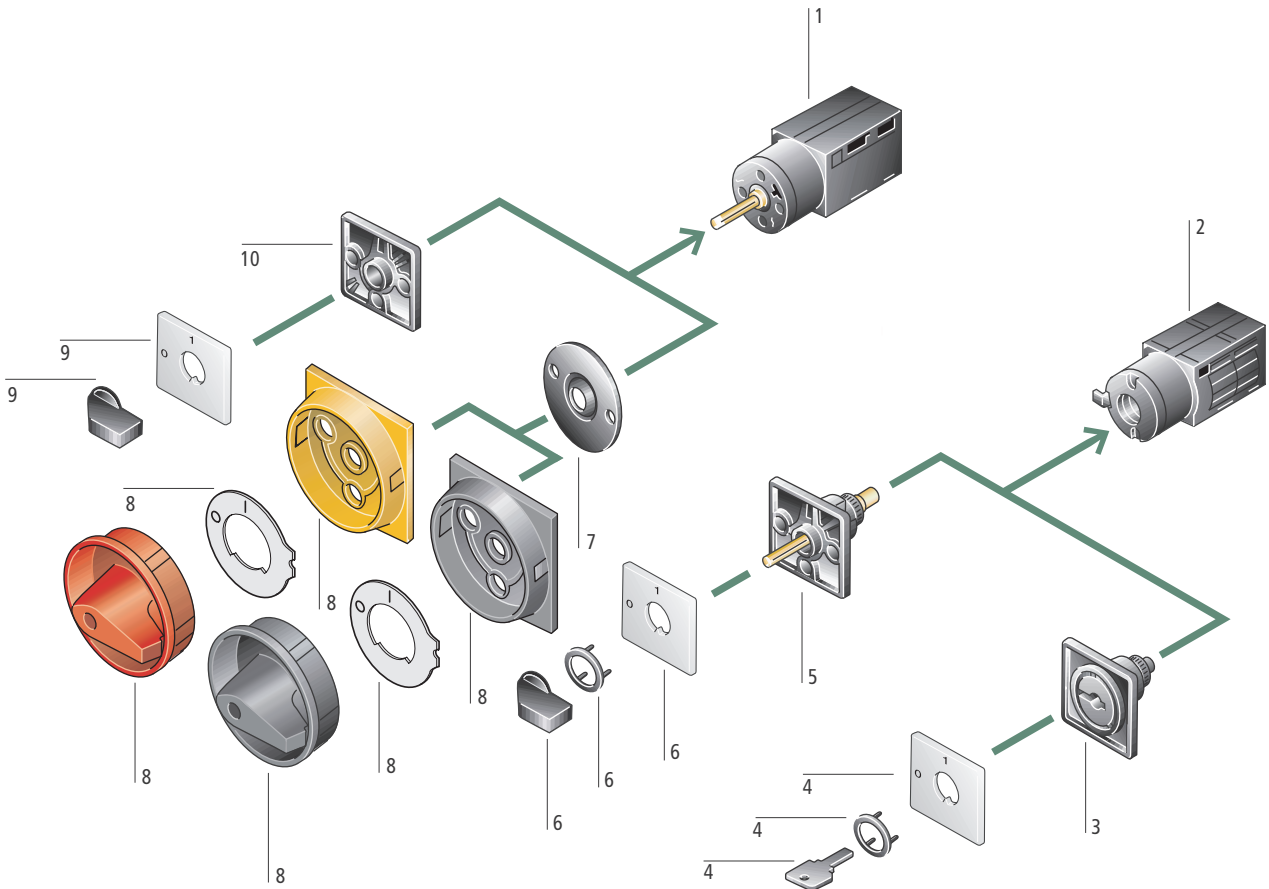

TM control switches

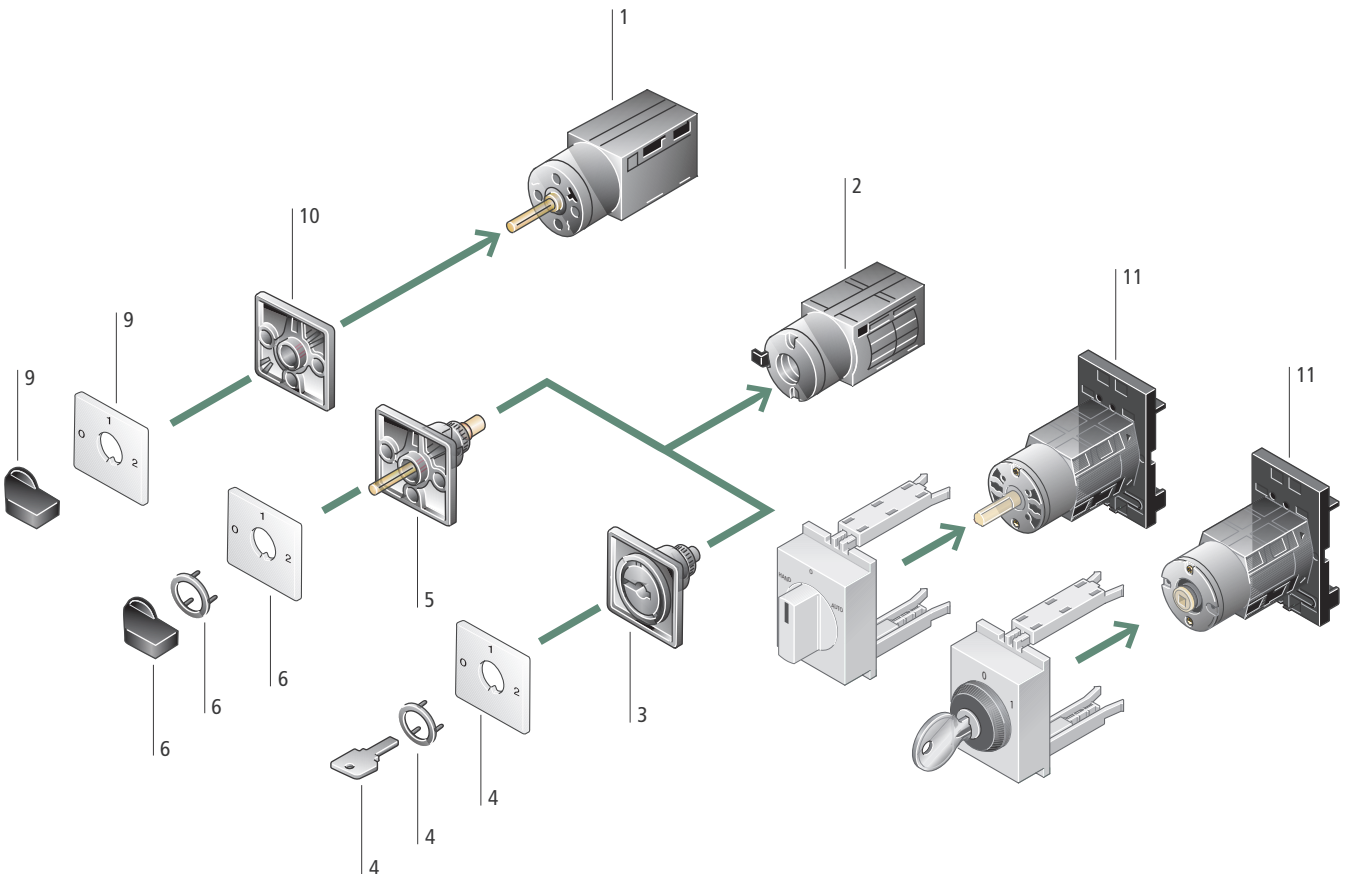

Moeller HPL0211-2004/2005

Flush mounting (.../E)	1
Front IP65	
Fitting from rear in panel sides, plates or doors	
Terminal: Pozidriv plus-minus screw	
Finger proof	
→ Page 7/56	

Flush mounting Control circuit isolators (.../E/SVB)	1
Front IP65	
To IEC/EN 60 947-5, VDE 0660	
Lockable in 0 (Off) position using 2 padlocks, 4 mm Ø or 1 padlock, 6 mm Ø	
Can be used for up to 250 V AC per contact	
Up to 6 contacts admissible	
→ Page 7/56	

Centre mounting (.../EZ)	2
Front IP65	
Mounting in a standard 16.2 mm Ø fixing hole or 22.3 mm Ø to IEC/EN 60 947-5-1 after removal of the supplied adapter	
→ Page 7/56	

Key operation for centre mounting	3,4
Supplied with two keys	
Option for key withdrawal at 90° with KABA lock cylinder	
Option for key withdrawal at 60° with RONIS lock cylinder	
→ Page 7/83	

Standard centre mounting switches	5,6
Black thumb-grip	
→ Page 7/56	

Control circuit isolators	7,8
Red rotary handle and yellow locking collar	
Black rotary handle and locking collar	
Lockable in the 0 (Off) position	
→ Page 7/56	

Standard flush mounting switches	9,10
Black thumb-grip	
→ Page 7/56	

Standard switches for distribution board mounting (IVS)	11
Flush mounting in service distribution boards	
Mounting width: 2 space units (45 mm mounting depth)	
Up to 2 contact units	
→ Page 7/56	



Product features

Contact chamber

- Rated uninterrupted current: 10 A
- Gold-plated contacts for safe switching of extra low voltages and currents even in corrosive atmospheres
- Positively opening contacts
- 1 to 2 contacts per contact chamber, up to 16 contacts per switch
- For switching of unequal potentials
- Control circuit reliability

Contact sequences (examples)

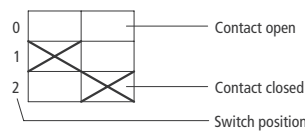

Switch position 1:
Contact 1 – 2 open,
Contact 3 – 4 closed.

Switching from 1 to 2:
Contact 1 – 2 closes with early make,
Contact 3 – 4 opens with late break.

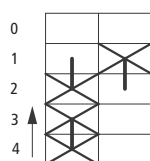

Switching from 2 to 3:
Contact 1 – 2 opens briefly.

Switching from 3 to 4:
Contact 1 – 2 remains closed.

Switch position

- Reliable switching due to indexing
- Switching angles 30°, 45°, 60°, 90°
- Automatic return with up to 6 contacts, switching angle ≥ 60°
- Complete rotation
- Switching angle of 360° allows complete rotation in both directions

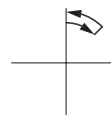
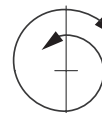

7/56 TM Mini Rotary SwitchesM Control Circuit Isolators, On-Off Switches

Moeller HPL0211-2004/2005

Rotary Switches, Switch-Disconnectors

Contact sequence	Front plate no.	No. of poles	Flush mounting		Centre mounting		Service distribution board mounting		Std. pack	
			Type Article no.	Price	Type Article no.	Price	Type Article no.	Price		
Control circuit isolators, 90°										
With padlocking facility, Lockable in the Off position Up to 250 V AC per contact										
		1	TM-1-8290/E/SVB 045477						1 off	
		1	TM-1-8290/E/SVB-SW 215351							
		2	TM-1-8291/E/SVB 045478							
		2	TM-1-8291/E/SVB-SW 215352							
		3	TM-2-8292/E/SVB 045484							
		3	TM-2-8292/E/SVB-SW 210955							
		3 + N	TM-2-8293/E/SVB 045485							
		3 + N	TM-2-8293/E/SVB-SW 215353							
		6	TM-3-8326/E/SVB 045498							
		6	TM-3-8326/E/SVB-SW 215354							
On-Off switches, 90°										
		1	TM-1-8290/E 070131		TM-1-8290/EZ 000693		TM-1-8290/IVS 225334			1 off
		2	TM-1-8291/E 072504		TM-1-8291/EZ 015073		TM-1-8291/IVS 225335			
		3	TM-2-8292/E 074877		TM-2-8292/EZ 015096		TM-2-8292/IVS 225336			
		3 + N	TM-2-8293/E 077250		TM-2-8293/EZ 045486		TM-2-8293/IVS 225337			
		6	TM-3-8326/E 079623		TM-3-8326/EZ 045499					

Moeller HPL0211-2004/2005







Rotary Switches, Switch-Disconnectors

Contact sequence	Front plate no.	No. of poles	Flush mounting		Centre mounting		Service distribution board mounting		Std. pack
			Type Article no.	Price See Price	Type Article no.	Price See Price	Type Article no.	Price See Price	
Changeover switches without 0 (Off) position, 60°									
		1	TM-1-8220/E 081996		TM-1-8220/EZ 000692		TM-1-8220/IVS 225338		1 off
		2	TM-2-8221/E 084369		TM-2-8221/EZ 015197		TM-2-8221/IVS 225339		
		3	TM-3-8222/E 086742		TM-3-8222/EZ 045493				
		4	TM-4-8223/E 089115		TM-4-8223/EZ 046119				
		5	TM-5-8369/E 091488		TM-5-8369/EZ 046126				
		6	TM-6-8370/E 093861		TM-6-8370/EZ 046130				
Changeover switches with 0 (Off) position, 60°									
		1	TM-1-8210/E 096234		TM-1-8210/EZ 015137		TM-1-8210/IVS 225340		1 off
		2	TM-2-8211/E 098607		TM-2-8211/EZ 015166		TM-2-8211/IVS 225341		
		3	TM-3-8212/E 010807		TM-3-8212/EZ 045491				
		4	TM-4-8213/E 013180		TM-4-8213/EZ 045847				
Changeover switches with 0 (Off) position, 90°									
		1	TM-1-8218/E 015553		TM-1-8218/EZ 045476				1 off
		2	TM-2-8219/E 017926		TM-2-8219/EZ 045482				
		3	TM-3-8299/E 020299		TM-3-8299/EZ 045497				
		3 + N	TM-4-8294/E 022672		TM-4-8294/EZ 046121				

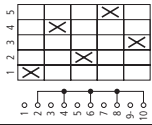

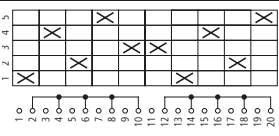
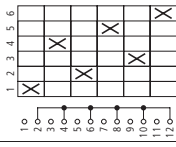
Contact sequence	Front plate no.	No. of poles	Flush mounting Front IP65		Centre mounting Front IP65		Service distribution board mounting Front IP 30		Std. pack
			Type Article no.	Price	Type Article no.	Price	Type Article no.	Price	
Hand-Auto switches, 60°									
		1			TM-1-8220F288/EZ 016925				1 off
		1	TM-1-15431/E 025045		TM-1-15431/EZ 000691		TM-1-15431/IVS 225342		
		2	TM-2-15432/E 027418		TM-2-15432/EZ 016878		TM-2-15432/IVS 225343		
		3	TM-3-15433/E 029791		TM-3-15433/EZ 045490				
Changeover switches with spring-return from both directions, 30°									
		1	TM-1-8214/E 032164		TM-1-8214/EZ 016673				1 off
		2	TM-2-8215/E 034537		TM-2-8215/EZ 045481				
		3	TM-3-8216/E 036910		TM-3-8216/EZ 045492				
Step switches without Off position, 60°									
3 steps									
		1	TM-2-8230/E 039283		TM-2-8230/EZ 000701		TM-2-8230/IVS 225344		1 off
		3	TM-5-8270/E 041656		TM-5-8270/EZ 046124				1 off
4 steps									
		1	TM-2-8231/E 044029		TM-2-8231/EZ 000700		TM-2-8231/IVS 225345		1 off
		3	TM-6-8271/E 046402		TM-6-8271/EZ 046128				1 off

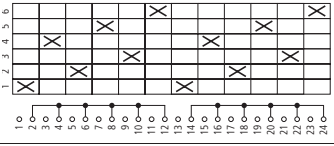
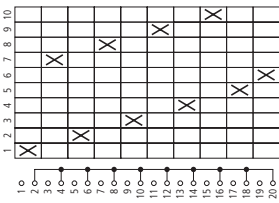
Moeller HPL0211-2004/2005

Contact sequence	Front plate no.	No. of poles	Flush mounting		Centre mounting		Std. pack
			Type Article no.	Price	Type Article no.	Price	
Changeover switches without 0 (Off) position, 60°							
5 steps 60°							
	 F 078	1	TM-3-8232/E 039298		TM-3-8232/EZ 015592		1 off
		2	TM-5-8252/E 041671		TM-5-8252/EZ 046123		1 off
6 steps 60° Without complete rotation							
	 F 079	1	TM-3-8233/E 053521		TM-3-8233/EZ 015630		1 off
		2	TM-6-8253/E 055894		TM-6-8253/EZ 046127		1 off
10 steps 30°							
	 F 011	1	TM-5-8237/E 069150		TM-5-8237/EZ 015661		1 off

Rotary Switches, Switch-Disconnectors











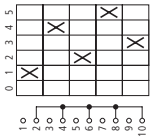

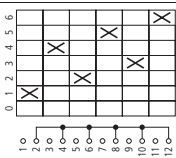

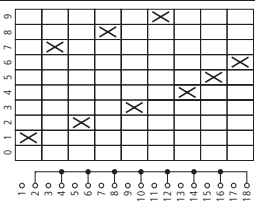

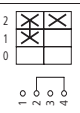

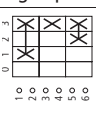

Contact sequence	Front plate no.	No. of poles	Flush mounting		Std. pack	Centre mounting		Std. pack
			Type Article no.	Price		Type Article no.	Price	
Step switches with additional 0 (Off) position								
2 steps 60°								
		1	TM-1-8240/E 058267		1 off	TM-1-8240/EZ 015226		1 off
		2	TM-2-8260/E 060640			TM-2-8260/EZ 045483		
		3	TM-3-8280/E 063013			TM-3-8280/EZ 045496		
3 steps 45°								
		1	TM-2-8241/E 065386		1 off	TM-2-8241/EZ 015256		1 off
		2	TM-3-8261/E 067759			TM-3-8261/EZ 000698		
		3	TM-5-8281/E 070132			TM-5-8281/EZ 046125		
4 steps 30°								
		1	TM-2-8242/E 072505		1 off	TM-2-8242/EZ 015506		1 off
		2	TM-4-8262/E 074878			TM-4-8262/EZ 046120		
		3	TM-6-8282/E 077251			TM-6-8282/EZ 046129		

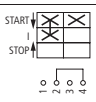
Control Switches: Step Switches, Group Switches, On-Off Switches, Spring-Return

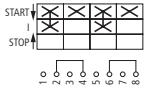
Moeller HPL0211-2004/2005

Rotary Switches, Switch-Disconnectors

Contact sequence	Front plate no.	No. of poles	Flush mounting		Centre mounting		Std. pack
			Type Article no.	Price	Type Article no.	Price	
Step switches with additional 0 (Off) position							
5 steps							
	 F 003	1	TM-3-8243/E 079624		1 off	TM-3-8243/EZ 015537	1 off
6 steps							
	 F 004	1	TM-3-8244/E 081997		1 off	TM-3-8244/EZ 045495	1 off
9 steps							
	 F 007	1	TM-5-8247/E 009741		1 off	TM-5-8247/EZ 015565	1 off
Group switches							
2 groups 60°							
	 F 075	1	TM-1-8310/E 084370		1 off	TM-1-8310/EZ 045479	1 off
3 groups 30°							
	 F 001	1	TM-2-8311/E 086743		1 off	TM-2-8311/EZ 045487	1 off
On-Off switches, spring-return, 30°							
On switches, spring-return							
	 F 023	1	TM-1-8175/E 091489		1 off	TM-1-8175/EZ 015690	1 off
On-Off switches, spring-return							
	 F 024	1	TM-1-8176/E 093862		1 off	TM-1-8176/EZ 016714	1 off
	 F 024	2	TM-2-8183/E 096235		1 off	TM-2-8183/EZ 045480	1 off
On-Off spring-return switches, 90°/30°							
With spring-return from START to 1							
	 F 119	1	TM-1-8178/E 098608		1 off	TM-1-8178/EZ 016786	1 off



Contact sequence	Front plate no.	No. of poles	Flush mounting		Centre mounting		Std. pack
			Type Article no.	Price See Price List	Type Article no.	Price See Price List	
Reversing switches with spring-return from START to 1 or 2, 60°/30°							
	F 121	1	TM-2-8177/E 010808		TM-2-8177/EZ 016838		1 off
Reversing switches, 60°							
	F 071	2	TM-2-8400/E 013181		TM-2-8400/EZ 045488		1 off
		3	TM-3-8401/E 015554		TM-3-8401/EZ 045500		1 off
Reversing switches with spring-return to 0, 30°							
	F 025	3	TM-3-8228/E 017927		TM-3-8228/EZ 045494		1 off
Coding switches, BCD code 0 – 9, 30°							
	F 007	1	TM-2-8550/E 020300		TM-2-8550/EZ 000699		1 off
Complementary BCD code 0 – 9, 30°							
	F 007	1	TM-2-8551/E 022673		TM-2-8551/EZ 045489		1 off
BCD code 0 – 9 + complement, 30°							
	F 007	1	TM-4-8552/E 025046		TM-4-8552/EZ 046122		1 off

Moeller HPL0211-2004/2005

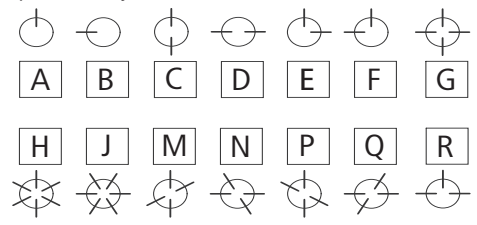
	For mounting form EZ		For mounting form IVS		Std. pack	Notes
	Type suffix Article no. When ordered with basic unit	Price See Price List	Type suffix Article no. When ordered with basic unit	Price See Price List		
KABA lock for 90° switching angle						
Degree of protection IP65, key withdrawable at:						
270°	+EZ/S-B 045459		+IVS/S-B 232036		1 off	Key operated lock mechanism including two keys. The key can be withdrawn only in specified positions, see diagrams below. However, the KABA lock mechanism for 90° can also be used for other switching angles provided the positions for key withdrawal correspond with those specified for the Type of switch. Example: +EZ/S-B can be used on a step switch having a switching angle of 30°, provided the key is to be withdrawn only in the Off position at 270°.
0 + 90°	+EZ/S-E 045462		+IVS/S-E 232040			
270 + 0°	+EZ/S-F 045463		+IVS/S-F 232038			
270 + 0 + 90 + 180°	+EZ/S-G 045464		+IVS/S-G 232043			
270 + 0 + 90°	+EZ/S-R 045471		+IVS/S-R 232042			
0°	+EZ/S-A 045458		+IVS/S-A 232034			
RONIS lock for 60° switching angle						
Degree of protection IP65, key withdrawable at:						
270 + 90°	+EZ/S-D 045461		+IVS/S-D 231976		1 off	Options for key withdrawal 
300 + 0 + 60 + 120 + 180 + 240°	+EZ/S-H 045465		+IVS/S-H 231977			
270 + 330 + 30 + 90 + 150 + 210°	+EZ/S-J 045466		+IVS/S-J 231978			
0 + 60 + 180 + 240°	+EZ/S-M 045467		+IVS/S-M 231979			
270 + 330 + 90 + 150°	+EZ/S-N 045468		+IVS/S-N 231980			
300 + 0 + 120 + 180°	+EZ/S-P 045469		+IVS/S-P 231981			
270 + 30 + 90 + 210°	+EZ/S-Q 045470		+IVS/S-Q 231982			
0 + 180°	+EZ/S-C 045460		+IVS/S-C 231975			

Position marking for the example

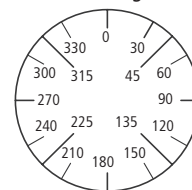

7/64 Non-Standard Switches
T0 Rotary Switches

Moeller HPL0211-2004/2005

Type	Article no.	Price See Price	Type	Article no.	Price See Price	Std. pack
T0 rotary switches						
T0-1-SOND*/E	907765		T0-5-SOND*/E	907769		1 off
T0-1-SOND*/EA/SVB	907776		T0-5-SOND*/EZ	907791		
T0-1-SOND*/EA/SVB-SW	908043		T0-5-SOND*/IVS	907810		
T0-1-SOND*/EZ	907787		T0-5-SOND*/Z	907843		
T0-1-SOND*/I1	207480					
T0-1-SOND*/I1/SVB	207481		T0-6-SOND*/E	907770		
T0-1-SOND*/I1/SVB-SW	207482		T0-6-SOND*/EZ	907792		
T0-1-SOND*/IVS	907806		T0-6-SOND*/IVS	907811		
T0-1-SOND*/IV/SVB	907817		T0-6-SOND*/Z	907844		
T0-1-SOND*/IV/SVB-SW	908054					
T0-1-SOND*/Z	907839		T0-7-SOND*/E	907771		
			T0-7-SOND*/EZ	907793		
T0-2-SOND*/E	907766		T0-7-SOND*/IVS	907812		
T0-2-SOND*/EA/SVB	907777		T0-7-SOND*/Z	907845		
T0-2-SOND*/EA/SVB-SW	908044					
T0-2-SOND*/EZ	907788		T0-8-SOND*/E	907772		
T0-2-SOND*/I1	207483		T0-8-SOND*/EZ	907794		
T0-2-SOND*/I1/SVB	207484		T0-8-SOND*/IVS	907813		
T0-2-SOND*/I1/SVB-SW	207485		T0-8-SOND*/Z	907846		
T0-2-SOND*/IVS	907807					
T0-2-SOND*/IV/SVB	907818		T0-9-SOND*/E	907773		
T0-2-SOND*/IV/SVB-SW	908055		T0-9-SOND*/EZ	907795		
T0-2-SOND*/Z	907840		T0-9-SOND*/IVS	907814		
			T0-9-SOND*/Z	907847		
T0-3-SOND*/E	907767					
T0-3-SOND*/EA/SVB	907778		T0-10-SOND*/E	907774		
T0-3-SOND*/EA/SVB-SW	908045		T0-10-SOND*/EZ	907796		
T0-3-SOND*/EZ	907789		T0-10-SOND*/IVS	907815		
T0-3-SOND*/I1	207486		T0-10-SOND*/Z	907848		
T0-3-SOND*/I1/SVB	207487					
T0-3-SOND*/I1/SVB-SW	207488		T0-11-SOND*/E	907775		
T0-3-SOND*/IVS	907808		T0-11-SOND*/EZ	907797		
T0-3-SOND*/IV/SVB	907819		T0-11-SOND*/IVS	907816		
T0-3-SOND*/IV/SVB-SW	908056		T0-11-SOND*/Z	907849		
T0-3-SOND*/Z	907841					
T0-4-SOND*/E	907768					
T0-4-SOND*/EA/SVB	907779					
T0-4-SOND*/EA/SVB-SW	908046					
T0-4-SOND*/EZ	907790					
T0-4-SOND*/I1	207489					
T0-4-SOND*/I1/SVB	207490					
T0-4-SOND*/I1/SVB-SW	207491					
T0-4-SOND*/IVS	907809					
T0-4-SOND*/IV/SVB	907820					
T0-4-SOND*/IV/SVB-SW	908057					
T0-4-SOND*/Z	907842					

Notes

Price valid for one T rotary switch with one non-standard contact sequence.
For the first order, please use the order form for non-standard contact sequences ("Ordering of non-standard contact sequences").
For re-orders, indicate the contact sequence number and the country identifier (e.g. 4711F).

Moeller HPL0211-2004/2005

Type	Article no.	Price See Price	Type	Article no.	Price See Price	Std. pack
T3 rotary switches						
T3-1-SOND*/E	907850		T3-5-SOND*/E	907854		1 off
T3-1-SOND*/EA/SVB	907861		T3-5-SOND*/EA/SVB	907865		
T3-1-SOND*/EA/SVB-SW	908080		T3-5-SOND*/EA/SVB-SW	908084		
T3-1-SOND*/EZ	907872		T3-5-SOND*/EZ	907876		
T3-1-SOND*/I2	207492		T3-5-SOND*/I2	207504		
T3-1-SOND*/I2/SVB	207493		T3-5-SOND*/I2/SVB	207506		
T3-1-SOND*/I2/SVB-SW	207494		T3-5-SOND*/I2/SVB-SW	207507		
T3-1-SOND*/V/SVB	907891		T3-5-SOND*/V/SVB	907895		
T3-1-SOND*/V/SVB-SW	908091		T3-5-SOND*/V/SVB-SW	908095		
T3-1-SOND*/Z	907913		T3-5-SOND*/Z	907917		
T3-2-SOND*/E	907851		T3-6-SOND*/E	907855		
T3-2-SOND*/EA/SVB	907862		T3-6-SOND*/EA/SVB	907866		
T3-2-SOND*/EA/SVB-SW	908081		T3-6-SOND*/EA/SVB-SW	908085		
T3-2-SOND*/EZ	907873		T3-6-SOND*/EZ	907877		
T3-2-SOND*/I2	207495		T3-6-SOND*/V/SVB	907896		
T3-2-SOND*/I2/SVB	207496		T3-6-SOND*/V/SVB-SW	908096		
T3-2-SOND*/I2/SVB-SW	207497		T3-6-SOND*/Z	907918		
T3-2-SOND*/V/SVB	907892					
T3-2-SOND*/V/SVB-SW	908092		T3-7-SOND*/E	907856		
T3-2-SOND*/Z	907914		T3-7-SOND*/EZ	907878		
			T3-7-SOND*/Z	907919		
T3-3-SOND*/E	907852					
T3-3-SOND*/EA/SVB	907863		T3-8-SOND*/E	907857		
T3-3-SOND*/EA/SVB-SW	908082		T3-8-SOND*/EZ	907879		
T3-3-SOND*/EZ	907874		T3-8-SOND*/Z	907920		
T3-3-SOND*/I2	207498					
T3-3-SOND*/I2/SVB	207499		T3-9-SOND*/E	907858		
T3-3-SOND*/I2/SVB-SW	207500		T3-9-SOND*/EZ	907880		
T3-3-SOND*/V/SVB	907893		T3-9-SOND*/Z	907921		
T3-3-SOND*/V/SVB-SW	908093					
T3-3-SOND*/Z	907915		T3-10-SOND*/E	907859		
			T3-10-SOND*/EZ	907881		
T3-4-SOND*/E	907853		T3-10-SOND*/Z	907922		
T3-4-SOND*/EA/SVB	907864					
T3-4-SOND*/EA/SVB-SW	908083		T3-11-SOND*/E	907860		
T3-4-SOND*/EZ	907875		T3-11-SOND*/EZ	907882		
T3-4-SOND*/I2	207501		T3-11-SOND*/Z	907923		
T3-4-SOND*/I2/SVB	207502					
T3-4-SOND*/I2/SVB-SW	207503					
T3-4-SOND*/V/SVB	907894					
T3-4-SOND*/V/SVB-SW	908094					
T3-4-SOND*/Z	907916					

Rotary Switches, Switch-Disconnectors



7/66 Non-Standard Switches T5B Rotary Switches

Moeller HPL0211-2004/2005

Rotary Switches, Switch-Disconnectors



Type	Article no.	Price See Price	Type	Article no.	Price See Price	Std. pack
T5B rotary switches						
T5B-1-SOND*/E	907924		T5B-5-SOND*/E	907928		1 off
T5B-1-SOND*/EA/SVB	907934		T5B-5-SOND*/EA/SVB	907938		
T5B-1-SOND*/EA/SVB-SW	908106		T5B-5-SOND*/EA/SVB-SW	908110		
T5B-1-SOND*/I4	207510		T5B-5-SOND*/V/SVB	907954		
T5B-1-SOND*/I4/SVB	207511		T5B-5-SOND*/V/SVB-SW	908118		
T5B-1-SOND*/I4/SVB-SW	207512		T5B-5-SOND*/Z	907972		
T5B-1-SOND*/V/SVB	907950					
T5B-1-SOND*/V/SVB-SW	908114		T5B-6-SOND*/E	907929		
T5B-1-SOND*/Z	907968		T5B-6-SOND*/EA/SVB	907939		
			T5B-6-SOND*/EA/SVB-SW	908111		
T5B-2-SOND*/E	907925		T5B-6-SOND*/V/SVB	907955		
T5B-2-SOND*/EA/SVB	907935		T5B-6-SOND*/V/SVB-SW	908119		
T5B-2-SOND*/EA/SVB-SW	908107		T5B-6-SOND*/Z	907973		
T5B-2-SOND*/I4	207514					
T5B-2-SOND*/I4/SVB	207515		T5B-7-SOND*/E	907930		
T5B-2-SOND*/I4/SVB-SW	207516		T5B-7-SOND*/EA/SVB	907940		
T5B-2-SOND*/V/SVB	907951		T5B-7-SOND*/EA/SVB-SW	908112		
T5B-2-SOND*/V/SVB-SW	908115		T5B-7-SOND*/V/SVB	907956		
T5B-2-SOND*/Z	907969		T5B-7-SOND*/V/SVB-SW	908120		
			T5B-7-SOND*/Z	907974		
T5B-3-SOND*/E	907926					
T5B-3-SOND*/EA/SVB	907936		T5B-8-SOND*/E	907931		
T5B-3-SOND*/EA/SVB-SW	908108		T5B-8-SOND*/EA/SVB	907941		
T5B-3-SOND*/I4	207518		T5B-8-SOND*/EA/SVB-SW	908113		
T5B-3-SOND*/I4/SVB	207519		T5B-8-SOND*/V/SVB	907957		
T5B-3-SOND*/I4/SVB-SW	207520		T5B-8-SOND*/V/SVB-SW	908121		
T5B-3-SOND*/V/SVB	907952		T5B-8-SOND*/Z	907975		
T5B-3-SOND*/V/SVB-SW	908116					
T5B-3-SOND*/Z	907970		T5B-9-SOND*/E	907932		
			T5B-9-SOND*/Z	907976		
T5B-4-SOND*/E	907927					
T5B-4-SOND*/EA/SVB	907937		T5B-10-SOND*/E	907933		
T5B-4-SOND*/EA/SVB-SW	908109		T5B-10-SOND*/Z	907977		
T5B-4-SOND*/I4	207521					
T5B-4-SOND*/I4/SVB	207522					
T5B-4-SOND*/I4/SVB-SW	207523					
T5B-4-SOND*/V/SVB	907953					
T5B-4-SOND*/V/SVB-SW	908117					
T5B-4-SOND*/Z	907971					

Notes

Price valid for one T rotary switch with one non-standard contact sequence.
 For the first order, please use the order form for non-standard contact sequences ("Ordering of non-standard contact sequences").
 For re-orders, indicate the contact sequence number and the country identifier (e.g. 4711F).

Moeller HPL0211-2004/2005

Type	Article no.	Price See Price	Type	Article no.	Price See Price	Std. pack
T5 rotary switches						
T5-1-SOND*/E	907978		T5-5-SOND*/E	907982		1 off
T5-1-SOND*/EA/SVB	908031		T5-5-SOND*/EA/SVB	907991		
T5-1-SOND*/EA/SVB-SW	908126		T5-5-SOND*/EA/SVB-SW	908130		
T5-1-SOND*/I5	207524		T5-5-SOND*/V/SVB	908007		
T5-1-SOND*/I5/SVB	207525		T5-5-SOND*/V/SVB-SW	908138		
T5-1-SOND*/I5/SVB-SW	207526		T5-5-SOND*/Z	908025		
T5-1-SOND*/V/SVB	908003					
T5-1-SOND*/V/SVB-SW	908134		T5-6-SOND*/E	907983		
T5-1-SOND*/Z	908021		T5-6-SOND*/EA/SVB	907992		
			T5-6-SOND*/EA/SVB-SW	908131		
T5-2-SOND*/E	907979		T5-6-SOND*/V/SVB	908008		
T5-2-SOND*/EA/SVB	907988		T5-6-SOND*/V/SVB-SW	908139		
T5-2-SOND*/EA/SVB-SW	908127		T5-6-SOND*/Z	908026		
T5-2-SOND*/I5	207527					
T5-2-SOND*/I5/SVB	207528		T5-7-SOND*/E	907984		
T5-2-SOND*/I5/SVB-SW	207529		T5-7-SOND*/EA/SVB	907993		
T5-2-SOND*/V/SVB	908004		T5-7-SOND*/EA/SVB-SW	908132		
T5-2-SOND*/V/SVB-SW	908135		T5-7-SOND*/V/SVB	908009		
T5-2-SOND*/Z	908022		T5-7-SOND*/V/SVB-SW	908140		
			T5-7-SOND*/Z	908027		
T5-3-SOND*/E	907980					
T5-3-SOND*/EA/SVB	907989		T5-8-SOND*/E	907985		
T5-3-SOND*/EA/SVB-SW	908128		T5-8-SOND*/EA/SVB	907994		
T5-3-SOND*/I5	207530		T5-8-SOND*/EA/SVB-SW	908133		
T5-3-SOND*/I5/SVB	207531		T5-8-SOND*/V/SVB	908010		
T5-3-SOND*/I5/SVB-SW	207532		T5-8-SOND*/V/SVB-SW	908141		
T5-3-SOND*/V/SVB	908005		T5-8-SOND*/Z	908028		
T5-3-SOND*/V/SVB-SW	908136					
T5-3-SOND*/Z	908023		T5-9-SOND*/E	907986		
T5-3-SOND*/E	907980		T5-9-SOND*/Z	908029		
T5-4-SOND*/E	907981		T5-10-SOND*/E	907987		
T5-4-SOND*/EA/SVB	907990		T5-10-SOND*/Z	908030		
T5-4-SOND*/EA/SVB-SW	908129					
T5-4-SOND*/I5	207533					
T5-4-SOND*/I5/SVB	207534					
T5-4-SOND*/I5/SVB-SW	207535					
T5-4-SOND*/V/SVB	908006					
T5-4-SOND*/V/SVB-SW	908137					

Rotary Switches, Switch-Disconnectors



	Type ¹⁾	Article no.	Price See Price	Type ²⁾	Article no.	Price See Price	Std. pack
TM non-standard switches	TM-1-SOND*/E	907749		TM-1-SOND-ERSTBESTELLUNG/E	208261		1 off
	TM-1-SOND*/EZ	907755		TM-1-SOND-ERSTBESTELLUNG/EZ	208262		
	TM-1-SOND*/IVS	225346		TM-1-SOND-ERSTBESTELLUNG/IVS	225347		
	TM-2-SOND*/E	907763		TM-2-SOND-ERSTBESTELLUNG/E	208263		
	TM-2-SOND*/EZ	907756		TM-2-SOND-ERSTBESTELLUNG/EZ	208264		
	TM-2-SOND*/IVS	225348		TM-2-SOND-ERSTBESTELLUNG/IVS	225349		
	TM-3-SOND*/E	907750		TM-3-SOND-ERSTBESTELLUNG/E	208265		
	TM-3-SOND*/EZ	907757		TM-3-SOND-ERSTBESTELLUNG/EZ	208266		
	TM-4-SOND*/E	907751		TM-4-SOND-ERSTBESTELLUNG/E	208267		
	TM-4-SOND*/EZ	907758		TM-4-SOND-ERSTBESTELLUNG/EZ	208268		
	TM-5-SOND*/E	907764		TM-5-SOND-ERSTBESTELLUNG/E	208269		
	TM-5-SOND*/EZ	907759		TM-5-SOND-ERSTBESTELLUNG/EZ	208270		
	TM-6-SOND*/E	907752		TM-6-SOND-ERSTBESTELLUNG/E	208271		
	TM-6-SOND*/EZ	907760		TM-6-SOND-ERSTBESTELLUNG/EZ	208272		
	TM-7-SOND*/E	907753		TM-7-SOND-ERSTBESTELLUNG/E	208273		
	TM-7-SOND*/EZ	907761		TM-7-SOND-ERSTBESTELLUNG/EZ	208274		
TM-8-SOND*/E	907754		TM-8-SOND-ERSTBESTELLUNG/E	208275			
TM-8-SOND*/EZ	907762		TM-8-SOND-ERSTBESTELLUNG/EZ	208276			

Notes

¹⁾ TM-...-SOND.../...:
For subsequent orders, for which the design number is already known. You do **not** need to use form FO2. The design number has 6 digits and must always be greater than 200000.

²⁾ TM-...-SOND-ERSTBESTELLUNG/...:
For initial orders submit a completed form.



Moeller HPL0211-2004/2005

Key to type references

↑ Switch size	↑ Number of contact units (2 contacts per contact unit)	↑ Contact sequence number	↑ Mounting form	↑ Accessories
	Max. units	Max. contacts		State in full with every order! For TM.../EZ only +EZ/S... is possible
T0	11	22	<ul style="list-style-type: none"> • Mounting form /E • Centre mounting /EZ (for T0, T3) • Surface mounting /I...¹⁾ • Service distribution board mounting /IVS (for T0) • Rear mounting /Z • Flush mounting main switches /EA/SVB²⁾ • Surface mounting main switches /I.../SVB • Rear mounting main switches /V/SVB²⁾ • Mounting forms for TM: /E, /EZ or /IVS 	
T3	11	22		
T5B	10	20		
T5	10	20		
TM	8	16		

Design notes for non-standard contact sequences

Contact sequence

The form on the next Page makes it easy for you to determine the contact sequence.
Master copy

Switching angle

30, 45, 60, 90°

Preferred angle: 60°

For On-Off switches: 90°

For main switches: 90° as FS 908

Changeover with interruption of contact between

2 positions (On-Off-On) not admissible with T0;

or T3 and TM = 30°, 45°; or with T5(T5B) = 30°

Star-delta switches only with switching angle ≥ 60°

Terminal markings

The terminals of the TM switches are numbered consecutively, starting at 1.

Spring-return

The switching movement is limited by a stop. The switch returns under spring pressure to the last indexed position. Where a switch has spring-return from both directions, a maximum of three positions can be traversed.

The return angle is < 1/2 switching angle. A maximum of 6 contacts can be returned at the same time.

The switching angle of spring-return TM mini rotary switches must be ≥ 60°.

Fleeting contacts

The duration of the fleeting contact depends primarily on the speed of actuation. If a contactor is to be actuated by means of a fleeting pulse, the switching angle of the rotary switch must not be less than 60°, or the switching pulse may be too short. Fleeting contacts always act in **both** directions.

Complete rotation

Possible only with a total switching angle of 360°. Unrestricted rotation in either direction. The number of switch positions times the switching angle must equal 360°. TM with 12 positions every 30° is possible only with complete rotation, not with stop.

Front plates

Front plates are part of the equipment supplied with an "Initial Order of T Rotary Switch Combinations" and therefore need **not** be ordered separately.

Number of contact units

$$\frac{\text{Number of contacts}}{2} = \text{Round up to nearest whole number}$$

Each contact chamber = contact unit has 1 or 2 contacts, each operated by a cam.

On T5(B) one cam operates both contacts.

Consequently for T5(B) the following applies:

Where the total switching angle is **less than 180°**, the contacts can be operated **independently** of one another. At switching angle of 180° and above, two contacts per chamber are possible only if their switching sequences are the same, but offset by 180° (e.g. T5B-4-8235 step switches).

Standard features

As for rotary switches by means of standard contact sequences



Notes

The sequence of the contacts may be changed if technical reasons so dictate.

On non-standard switches, links are only possible between even numbers or odd numbers. Links between an even number and an odd number cannot be supplied ex-factory and must be supplied by the user at installation.

¹⁾ T0-.../11 up to 4 contact units

T3-.../12 up to 5 contact units

²⁾ T0 with up to 8 contacts = 4 contact units,

T3 with up to 12 contacts = 6 contact units

7/70 Ordering of Non-Standard Contact Sequences, Ordering Example

T Rotary Switches, TM Mini Rotary Switches

Moeller HPL0211-2004/2005

Rotary Switches, Switch-Disconnectors



Binding document for initial orders for T rotary switch combinations

Order number: 4444 2 Item: Office: COFA Name: H73

Customer: 2R: 2A C0 Customer number: !X4444X Date: 11/11/11

Quantity: 3 Switching angle: Type: No. of contacts: Mounting form:

30 TM
 45 T0
 60 T3
 90 T5B
 T5

1 12
 2 13
 3 14
 4 15
 5 16
 6 17
 7 18
 8 19
 9 20
 10 21
 11 22

E
 EA/SVB EA/SVB-SW
 EZ
 I...
 I.../SVB I.../SVB-SW
 IVS
 V/SVB V/SVB-SW
 Z
 + ST-0
 + _____

Max. characters per switching angle on FS plate					
Degrees	TM-E	TM-EZ	TM-IVS	T0(3)	T5(B)
0,180	5	5	6	13	13
30, 210, 330	8	7	4	8	8
45, 135, 225, 315	6	5	4	6	7
60, 120, 240, 300	5	5	3	5	7
90, 270	5	4	1	4	7
150	4	4	4	8	8

Front plate no. FS 42 00W

Complete rotation

Spring-return

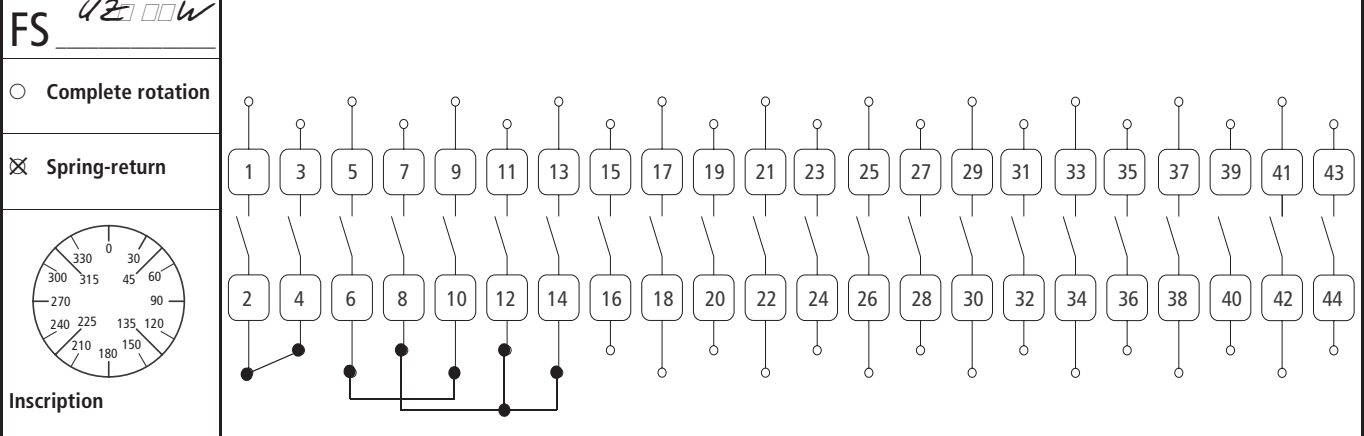

Degrees	1	2	3	4	5	6	7	8	9	10	11	12	13	14	15	16	17	18	19	20	21	22	23	24	25	26	27	28	29	30	31	32	33	34	35	36	37	38	39	40	41	42	43	44				
270	1																																															
300																																																
315																																																
330	2																																															
0																																																
30	3																																															
45																																																
60	4																																															
90																																																
120																																																
135																																																
150																																																
180																																																
210																																																
225																																																
240																																																

Key withdrawable Type for re-ordering (to be filled in by factory) T

The sequence of the contacts may be changed if technical reasons so dictate.

Key withdrawability with ..S-T0 and SVA-T3:

Pos. 1: Key withdrawable
 Pos. 2: Key withdrawable
 Pos. 3: Key withdrawable
 Pos. 4: Key not withdrawable

} With SVA-T3 it is possible to switch between Pos. 1 and 2 even after the key has been withdrawn.

For Immediate Delivery call KMParts.com at (866) 595-9616

Moeller HPL0211-2004/2005



Binding document for initial orders for T rotary switch combinations

Order number:	Item:	Office:	Name:
Customer:		Customer number:	Date:

Note: The number of possible contacts, as well as the possible combinations with mounting forms are shown in the Main Catalogue.	Quantity:	Switching angle:	Type:	No. of contacts:	Mounting form:
	Euro/each:	<input type="checkbox"/> 30 <input type="checkbox"/> 45 <input type="checkbox"/> 60 <input type="checkbox"/> 90	<input type="checkbox"/> TM <input type="checkbox"/> T0 <input type="checkbox"/> T3 <input type="checkbox"/> T5B <input type="checkbox"/> T5	<input type="checkbox"/> 1 <input type="checkbox"/> 2 <input type="checkbox"/> 3 <input type="checkbox"/> 4 <input type="checkbox"/> 5 <input type="checkbox"/> 6 <input type="checkbox"/> 7 <input type="checkbox"/> 8 <input type="checkbox"/> 9 <input type="checkbox"/> 10 <input type="checkbox"/> 11	<input type="checkbox"/> 12 <input type="checkbox"/> 13 <input type="checkbox"/> 14 <input type="checkbox"/> 15 <input type="checkbox"/> 16 <input type="checkbox"/> 17 <input type="checkbox"/> 18 <input type="checkbox"/> 19 <input type="checkbox"/> 20 <input type="checkbox"/> 21 <input type="checkbox"/> 22

Max. characters per switching angle on FS plate					
Degrees	TM-E	TM-EZ	TM-IVS	T0(3)	T5(B)
0,180	5	5	6	13	13
30, 210, 330	8	7	4	8	8
45, 135, 225, 315	6	5	4	6	7
60, 120, 240, 300	5	5	3	5	7
90, 270	5	4	1	4	7
150	4	4	4	8	8

The sequence of the contacts may be changed if technical reasons so dictate.

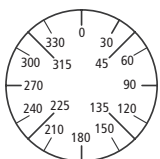
Front plate no. FS _____ <input type="radio"/> Complete rotation <input type="radio"/> Spring-return  Inscription	Contact units <table style="width: 100%; text-align: center; border-collapse: collapse;"> <tr> <td style="border: 1px solid black; width: 20px;">1</td><td style="border: 1px solid black; width: 20px;">2</td><td style="border: 1px solid black; width: 20px;">3</td><td style="border: 1px solid black; width: 20px;">4</td><td style="border: 1px solid black; width: 20px;">5</td><td style="border: 1px solid black; width: 20px;">6</td><td style="border: 1px solid black; width: 20px;">7</td><td style="border: 1px solid black; width: 20px;">8</td><td style="border: 1px solid black; width: 20px;">9</td><td style="border: 1px solid black; width: 20px;">10</td><td style="border: 1px solid black; width: 20px;">11</td> </tr> <tr> <td style="border: 1px solid black; width: 20px;">12</td><td style="border: 1px solid black; width: 20px;">13</td><td style="border: 1px solid black; width: 20px;">14</td><td style="border: 1px solid black; width: 20px;">15</td><td style="border: 1px solid black; width: 20px;">16</td><td style="border: 1px solid black; width: 20px;">17</td><td style="border: 1px solid black; width: 20px;">18</td><td style="border: 1px solid black; width: 20px;">19</td><td style="border: 1px solid black; width: 20px;">20</td><td style="border: 1px solid black; width: 20px;">21</td><td style="border: 1px solid black; width: 20px;">22</td> </tr> <tr> <td style="border: 1px solid black; width: 20px;">23</td><td style="border: 1px solid black; width: 20px;">24</td><td style="border: 1px solid black; width: 20px;">25</td><td style="border: 1px solid black; width: 20px;">26</td><td style="border: 1px solid black; width: 20px;">27</td><td style="border: 1px solid black; width: 20px;">28</td><td style="border: 1px solid black; width: 20px;">29</td><td style="border: 1px solid black; width: 20px;">30</td><td style="border: 1px solid black; width: 20px;">31</td><td style="border: 1px solid black; width: 20px;">32</td><td style="border: 1px solid black; width: 20px;">33</td> </tr> <tr> <td style="border: 1px solid black; width: 20px;">34</td><td style="border: 1px solid black; width: 20px;">35</td><td style="border: 1px solid black; width: 20px;">36</td><td style="border: 1px solid black; width: 20px;">37</td><td style="border: 1px solid black; width: 20px;">38</td><td style="border: 1px solid black; width: 20px;">39</td><td style="border: 1px solid black; width: 20px;">40</td><td style="border: 1px solid black; width: 20px;">41</td><td style="border: 1px solid black; width: 20px;">42</td><td style="border: 1px solid black; width: 20px;">43</td><td style="border: 1px solid black; width: 20px;">44</td> </tr> </table>	1	2	3	4	5	6	7	8	9	10	11	12	13	14	15	16	17	18	19	20	21	22	23	24	25	26	27	28	29	30	31	32	33	34	35	36	37	38	39	40	41	42	43	44
1	2	3	4	5	6	7	8	9	10	11																																			
12	13	14	15	16	17	18	19	20	21	22																																			
23	24	25	26	27	28	29	30	31	32	33																																			
34	35	36	37	38	39	40	41	42	43	44																																			

Degrees	1	3	5	7	9	11	13	15	17	19	21	23	25	27	29	31	33	35	37	39	41	43
	2	4	6	8	10	12	14	16	18	20	22	24	26	28	30	32	34	36	38	40	42	44
270																						
300																						
315																						
330																						
0																						
30																						
45																						
60																						
90																						
120																						
135																						
150																						
180																						
210																						
225																						
240																						

Key withdrawable	<input checked="" type="checkbox"/> Type for re-ordering (to be filled in by factory)	T _____
------------------	---	----------------

Rotary Switches, Switch-Disconnectors





Binding document for initial orders of non-standard front plates

Order number:		Item:	
Office:		Name:	
Customer:		Customer number:	
Quantity:	Euro/each:	Date:	

The text is always centred in the text box

Non-Standard Front Plates

Inscription:
Front plate with black lettering

Insert text

Note the maximum number of characters allowed outside the marked areas!

Type

FS-SOND-T0 (T3, P1)

Height of letters
 ≤ 2 characters 4 mm
 ≥ 2 characters 3 mm

FS-SOND-P3 (T5B, T5)

Height of letters
 ≤ 2 characters 8 mm
 ≥ 2 characters 5 mm

FS-SOND-TM-E

FS-SOND-TM-EZ

≤ 2 characters approx. 3.5 mm
 ≥ 2 characters 3 mm

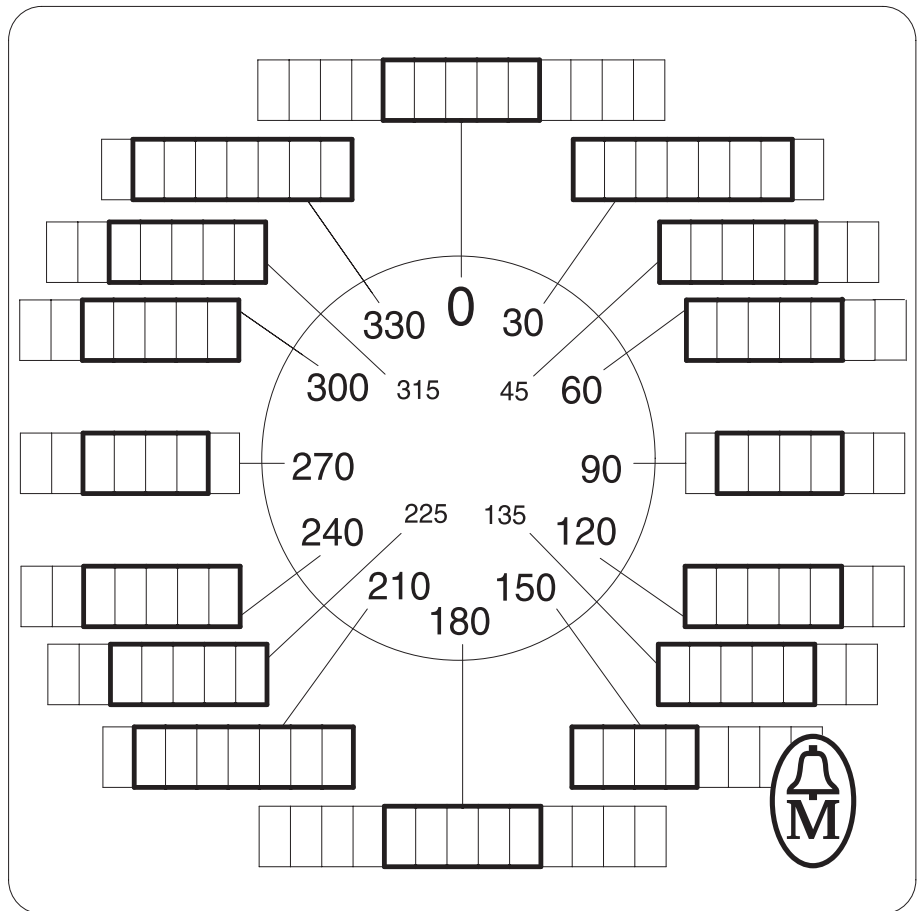

For P1 and P3 complete only the 270° and 0° positions

Max. number of characters possible

Position	TM-E	TM-EZ	T0/P1	T5/P3
0, 180	5	5	13	13
30, 210, 330	8	7	8	8
45, 135, 225, 315	6	5	6	7
60, 120, 240, 300	5	5	5	7
90, 270	5	4	4	7
150	4	4	8	8

Dimensions

Type	Size of front plate
TM-.../E	29 × 29 (for frame size 30 × 30)
TM-.../EZ(-...)	29 × 29 (for frame size 30 × 30)
T0, T3, P1	45 × 45 (for frame size 48 × 48)
P3, T5, T5B	84 × 84 (for frame size 88 × 88)

Type for re-ordering (to be filled in by factory)

FS

Moeller HPL0211-2004/2005

The component lifespan depends on the breaking current and the utilization category ¹⁾

To ensure a reasonable service life in utilization category AC-4 (extreme load: 100 % inching, reversing or plugging) the stand-still current of the motor should not exceed the rated current of the AC-21A switch.

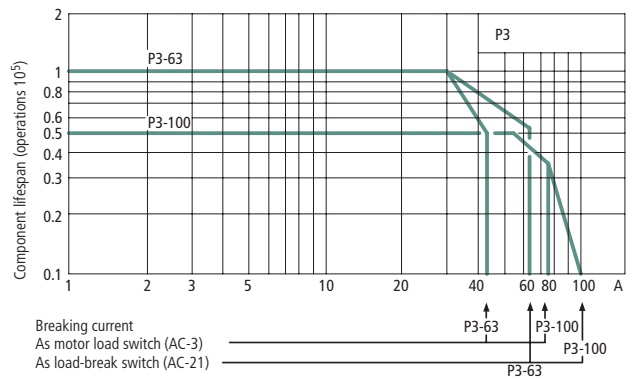
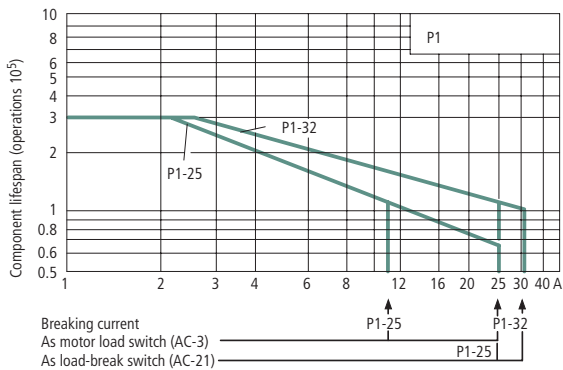
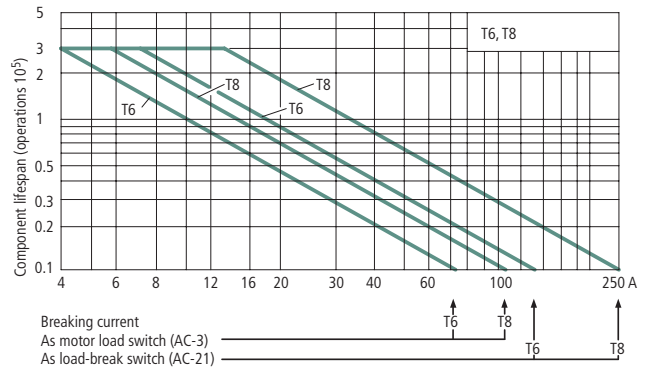
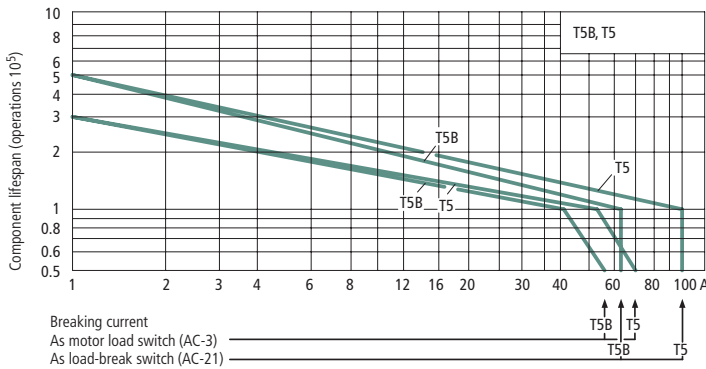
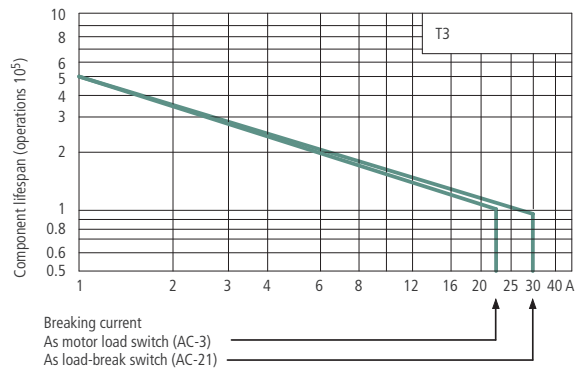
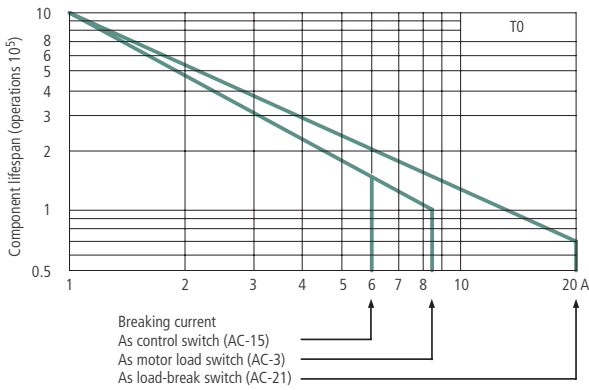

Notes

¹⁾ AC-3 and AC-21 at 400 V, AC-15 at 230 V

Moeller HPL0211-2004/2005

			T0-...	T3-...
General technical data				
Standards			IEC/EN 60 947, VDE 0660, IEC/EN 60 204, CSA, UL Switch-disconnectors to IEC/EN 60947-3 Load-break switches to IEC/EN 60 947-3	
Lifespan, mechanical	Operations	$\times 10^6$	1	0.5
Maximum operating frequency	Operations/h		3000	3000
Climatic proofing			Damp heat, constant, to IEC 60068-2-78, cyclical, to IEC 60068-2-30	
Ambient temperature				
Open		°C	-25/+50	-25/+50
Enclosed		°C	-25/+40	-25/+40
Mounting position			As required	
Mounting interval			mm ≥ 4	
Mechanical shock resistance (shock duration 20 ms)			g > 15	
Contacts				
Rated operational voltage	U_e	V AC	690	690
Rated impulse withstand voltage	U_{imp}	V AC	6000	6000
Overvoltage category/pollution degree			III/3	
Rated uninterrupted current				
Open	I_u	A	20	32
Enclosed	I_u	A	20	32
Load carrying capacity in intermittent operation, Class 12				
AB 25 % DF		$\times I_e$	2	2
AB 40 % DF		$\times I_e$	1.6	1.6
AB 60 % DF		$\times I_e$	1.3	1.3
Short-circuit rating				
Fuse		A gG/gL	20	35
Rated short-time withstand current (1s current)	I_{cw}	A _{rms}	320	650
Safe isolation to IEC 536				
between contacts		V AC	440	440
Switching angle			°	
			90	90
			60	60
			45	45
			30	30
Contact units			max.11	
Double-break contacts			max.22	
Current heat loss per contact at I_e			W	
			0.6	1.1
Terminal capacity				
Solid or stranded			mm ²	
			1 \times (1 - 2.5) 2 \times (1 - 2.5)	1 \times (1 - 6) 2 \times (1 - 6)
Flexible with ferrule to DIN 46228			mm ²	
			1 \times (0.75 - 1.5) 2 \times (0.75 - 1.5)	1 \times (0.75 - 4) 2 \times (0.75 - 4)
Flat conductor connection			mm ²	
			-	-
Terminal screw			M3.5	
Tightening torque			Nm	
			1	1,6

Notes For mechanical shock resistance: T3.../I... $> 12g$
 Applies to T0(3).../SVB: isolating characteristics to IEC/EN 60947 for rated operational voltage U_e up to 500 V AC
 Applies to rated uninterrupted current I_u per contact: with T5-4-8344/I5 max. 95 A
 For terminal capacity solid, stranded and flexible:
 T0(3), (6), (8)...: Maximum of 2 cross-section sizes difference admissible between 2 conductors
 T5(B)-...: Maximum of 1 cross-section size difference admissible between 2 conductors
 For the Type T8-3-8342/...: switching angle = 90° and flat conductor connection = 1 flat conductor 25 \times 5 or 2 flat conductors

Moeller HPL0211-2004/2005

T5B-...	T5-...	T6-3-8212/E/HI12	T6-160...	T8-...
IEC/EN 60 947, VDE 0660, IEC/EN 60 204, CSA, UL Switch-disconnectors to IEC/EN 60947-3 Load-break switches to IEC/EN 60 947-3				
0.5	0.5	0.1	0.1	0.1
3000	3000	50	50	50
Damp heat, constant, to IEC 60068-2-78, cyclical, to IEC 60068-2-30				
-25/+50	-25/+50	-25/+50	-25/+50	-25/+50
-25/+40	-25/+40	-25/+40	-25/+40	-25/+40
As required	As required	As required	As required	As required
≥ 4	≥ 4	-	-	-
> 15	> 15	-	-	-
690	690	690	690	690
6000	6000	6000	8000	8000
III/3	III/3	III/3	III/3	III/3
63	100	125	160	315
63	100	125	160	275
2	2	2	2	2
1.6	1.6	1.6	1.6	1.6
1.3	1.3	1.3	1.3	1.3
80	100	200	160	315
1300	1850	2000	3000	4200
440	440	-	-	-
90	90	90	90	90
60	60	60	60	60
45	45			
30	30			
max.10	max.10	max.3	max.3	max.3
max.20	max.20	max.6	max.6	max.6
4.5	7.5	11	11	11
1 \times (2.5 - 35) 2 \times (2.5 - 16)	1 \times (2.5 - 35) 2 \times (2.5 - 16)	1 \times 70 2 \times 25	1 \times 95 2 \times 25	150
1 \times (1.5 - 25) 2 \times (1.5 - 10)	1 \times (1.5 - 25) 2 \times (1.5 - 10)	1 \times 50 2 \times 16	1 \times 50 2 \times 16	120
-	-	-	-	1 \times (25 \times 5) 2 \times (20 \times 3)
M6	M6	M6	M5, Inbus	M12
4	4	5,6	14	25

Moeller HPL0211-2004/2005

Moeller HPL0211-2004/2005

				T0-...	T3-...
Switching capacity					
AC					
Rated making capacity $\cos \varphi = 0.35$		A		130	320
Rated breaking capacity	230 V	A		100	260
Motor load switches $\cos \varphi = 0.35$	400/415 V	A		110	260
	500 V	A		80	240
	690 V	A		60	170
Rated operational current	440 V	I_e	A	20	32
Load-break switches AC-21A					
Motor rating	230 V	P	kW	3	6.5
Motor load switches AC-3	230 V Star-delta	P	kW	4	11
	400/415 V	P	kW	4	12
	400/415 V Star-delta	P	kW	5.5	18.5
	500 V	P	kW	5.5	15
	500 V Star-delta	P	kW	7.5	22
	690 V	P	kW	4	15
	690 V Star-delta	P	kW	5.5	22
Motor rating	230 V	P	kW	3.5	7.5
Motor load switches AC-23A	400/415 V	P	kW	6.5	13
	500 V	P	kW	7.5	15
	690 V	P	kW	–	–
Rated operational current AC-15	230 V	I_e	A	6	10
Control switches	400/415 V	I_e	A	4	6
	500 V	I_e	A	2	4
DC					
DC-1, Load-break switches L/R = 1 ms	Rated operational current	I_e	A	10	25
	Voltage per contact pair in series	V		60	60
DC-21A	Rated operational current 240 V	I_e	A	1	1
	240 V Contacts	Qty.		1	1
DC-23A, Motor load switches L/R = 15 ms	24 V	Rated operational current	I_e	A	10
		Contacts	Qty.		1
	48 V	Rated operational current	I_e	A	10
		Contacts	Qty.		2
	60 V	Rated operational current	I_e	A	10
		Contacts	Qty.		3
	120 V	Rated operational current	I_e	A	5
		Contacts	Qty.		3
	240 V	Rated operational current	I_e	A	5
		Contacts	Qty.		5
DC-13, Control switches L/R = 50 ms	Rated operational current	I_e	A	10	20
	Voltage per contact pair in series	V		32	32
Control circuit reliability at 24 V DC, 10 mA	Fault probability	H_f		< 10 ⁻⁵ , < 1 fault in 100000 operations	
Auxiliary contacts					
Standards					
Rated insulation voltage	U_i	V AC			
Rated uninterrupted current	I_u	A			
Rated operational current					
AC-15 at 230 V	I_e	A			
400/415 V	I_e	A			
Short-circuit rating					
Max. fuse		A gG/gL			
Terminal capacity					
Solid		mm ²			
Flexible with ferrule to DIN 46228		mm ²			
Tightening torque		Nm			
Control circuit reliability at 24 V DC, 10 mA	Fault probability	H_f			

T5B-...	T5-...	T6-3-8212/E/HI12	T6-160...	T8-...
800	950	1600	1600	2390
520	760	1280	1280	1910
600	740	900	900	1800
480	590	880	880	1200
340	420	340	340	420
63	100	125	160	315
15	22	22	22	22
22	30	22	22	37
22	30	37	45	55
37	45	37	45	55
22	37	37	37	37
37	55	37	37	37
22	30	22	22	37
37	45	22	22	37
15	18.5	37	37	75
22	30	45	55	132
22	37	55	55	75
22	30	30	30	37
16	16	–	–	–
6	6	–	–	–
4	4	–	–	–
63	80	125	125	315
60	60	42	42	42
–	–	–	–	–
–	–	–	–	–
50	–	125	125	250
1	–	1	1	1
50	–	125	125	250
2	–	2	2	2
50	–	125	125	125
3	–	3	3	3
25	–	50	50	50
3	–	3	3	3
20	–	–	–	–
6	–	–	–	–
25	–	125	125	250
24	–	24	24	–
< 10 ⁻⁵ , < 1 fault in 100000 operations				
–	–	–	Control circuit isolators to IEC/EN 60947-5 ☺	
–	–	–	500	500
–	–	–	10	10
–	–	–	6	6
–	–	–	4	4
–	–	–	10	10
–	–	–	0.75 – 2.5	0.75 – 2.5
–	–	–	0.5 – 1.5	0.5 – 1.5
–	–	–	0.35	0.35
–	–	–	< 10 ⁻⁵ , < 1 fault in 100 000 operations	

				P1-25	P1-32	P3-63	P3-100
General technical data							
Standards				IEC/EN 60947, VDE 0660, IEC/EN 60204, CSA, UL Switch-disconnectors to IEC/EN 60947-3			
Lifespan, mechanical		Operations	$\times 10^6$	0.3	0.3	0.1	0.1
Maximum operating frequency		Operations/h		50	50	50	50
Climatic proofing				Damp heat, constant, to IEC 60068-2-78; cyclical, to IEC 60068-2-30			
Ambient temperature	Open		°C	-25/+50	-25/+50	-25/+50	-25/+50
	Enclosed		°C	-25/+40	-25/+40	-25/+40	-25/+40
Mounting position				As required	As required	As required	As required
Mounting interval				≥ 4	≥ 4	≥ 4	≥ 4
Mechanical shock resistance (IEC/EN 60068-2-27)	Half-sinusoidal shock 20 ms		g	15	15	15	15
Contacts							
Rated operational voltage		U_e	V AC	690	690	690	690
Rated impulse withstand voltage		U_{imp}	V AC	6000	6000	6000	6000
Overvoltage category/pollution degree				III/3	III/3	III/3	III/3
Rated uninterrupted current		I_u	A	25	32	63	100
Load carrying capacity in intermittent operation, Class 12	AB 60 % DF		$\times I_e$	1.3	1.3	1.3	1.3
	AB 40 % DF		$\times I_e$	1.6	1.6	1.6	1.6
	AB 25 % DF		$\times I_e$	2	2	2	2
Short-circuit rating	Fuse		A gG/gL	25	50	80	100
Rated short-time withstand current (1s current)		I_{cw}	A_{rms}	640	640	1260	2000
Isolating characteristics to IEC/EN 60 947			V AC	≤ 690	≤ 690	≤ 690	≤ 690
Safe isolation to IEC 536							
Safe isolation to IEC 536 between auxiliary contacts and main contacts			V AC	440	440	440	440
Switching angle			°	90	90	90	90
Contacts			Qty.	max. 3 (+N)	max. 3 (+N)	max. 3 (+N)	max. 3 (+N)
Current heat loss per contact at I_e			W	1.1	1.8	4.5	7.5
Terminal capacity							
Solid or stranded			mm ²	1 \times (1.5 – 6) 2 \times (1.5 – 6)	1 \times (1.5 – 6) 2 \times (1.5 – 6)	1 \times (2.5 – 35) 2 \times (2.5 – 10)	1 \times (2.5 – 35) 2 \times (2.5 – 10)
Terminal capacity Flexible with ferrule to DIN 46 228			mm ²	1 \times (1 – 4) 2 \times (1 – 4)	1 \times (1 – 4) 2 \times (1 – 4)	1 \times (1.5 – 25) 2 \times (1.5 – 6)	1 \times (1.5 – 25) 2 \times (1.5 – 6)
Terminal screw				M4	M4	M5	M5
Tightening torque			Nm	1,6	1,6	3	3

Notes Main switch characteristics to IEC/EN 60 204; positive opening of contacts, operator element positively located on shaft
The rated uninterrupted current I_u is given at max. connected cross-section.
For terminal capacity solid, stranded and flexible:
Max. 2 cross-section sizes difference admissible when using 2 conductors.

Moeller HPL0211-2004/2005

					P1-25	P1-32	P3-63	P3-100
Switching capacity								
AC								
Rated making capacity $\cos \varphi = 0.35$			A		240	320	800	950
Rated breaking capacity	230 V		A		190	260	640	760
Motor load switches $\cos \varphi = 0.35$	400/415 V		A		150	300	600	740
	500 V		A		170	290	590	880
	690 V		A		150	250	340	520
Rated operational current Load-break switches AC-21A	440 V	I_e	A		25	32	63	100
Motor rating	230 V	P	kW		5.5	7.5	15	22
Motor load switches AC-3	400/415 V	P	kW		7.5	13	30	37
	500 V	P	kW		7.5	18.5	30	45
	690 V	P	kW		7.5	15	30	37
Motor rating	230 V	P	kW		7	8.5	18.5	30
Motor load switches AC-23A	400/415 V	P	kW		13	15	37	50
	500 V	P	kW		11	18.5	37	65
	690 V	P	kW		11	18.5	30	45
DC								
DC-1		Rated operational current	I_e	A	25	32	63	100
Load-break switches L/R = 1 ms		Voltage per contact pair in series		V	60	60	60	60
DC-23A	24 V	Rated operational current	I_e	A	25	25	50	50
Motor load switches L/R = 15 ms		Contacts		Qty.	1	1	1	1
	48 V	Rated operational current	I_e	A	25	25	50	50
		Contacts		Qty.	2	2	2	2
	60 V	Rated operational current	I_e	A	25	25	50	50
		Contacts		Qty.	3	3	3	3
	120 V	Rated operational current	I_e	A	12	12	25	25
		Contacts		Qty.	3	3	3	3

Notes Main switch characteristics to IEC/EN 60204; positive opening of contacts, operator element positively located on shaft
The rated uninterrupted current I_u is given at max. connected cross-section.
For terminal capacity solid, stranded and flexible:
Max. 2 cross-section sizes difference admissible when using 2 conductors.

Rotary Switches, Switch-Disconnectors



			P5-125	P5-160	P5-250	P5-315		
General technical data								
Standards			IEC/EN 60947, VDE 0660, IEC/EN 60 204, CSA, UL Switch-disconnectors to IEC/EN 60947-78					
Lifespan, mechanical	Operations	$\times 10^6$	0.1	0.1	0.08	0.08		
Maximum operating frequency	Operations/h		50	50	50	50		
Climatic proofing			Damp heat, constant, to IEC 60068-2-3; cyclical, to IEC 60068-2-30					
Ambient temperature	Open	$^{\circ}\text{C}$	-25/+50	-25/+50	-25/+50	-25/+50		
	Enclosed	$^{\circ}\text{C}$	-25/+40	-25/+40	-25/+40	-25/+40		
Mounting position			As required	As required	As required	As required		
Contacts								
Rated operational voltage			U_e	V AC	690	690	690	690
Rated impulse withstand voltage			U_{imp}	V AC	8000	8000	8000	8000
Overvoltage category/pollution degree					III/3	III/3	III/3	III/3
Rated uninterrupted current			I_u	A	125	160	250	315
Load carrying capacity in intermittent operation, Class 12	AB 60 % DF	$\times I_e$	1.3	1.3	1.3	1.3	1.3	
	AB 40 % DF	$\times I_e$	1.6	1.6	1.6	1.6	1.6	
	AB 25 % DF	$\times I_e$	2	2	2	2	2	
Short-circuit rating	Fuse		A gG/gL	125	160	250	315	
Rated short-time withstand current (1s current)			I_{cw}	A_{rms}	2500	3000	4600	5800
Isolating characteristics to IEC/EN 60947				V AC	≤ 690	≤ 690	≤ 690	≤ 690
Safe isolation to IEC 536								
Safe isolation to IEC 536 between auxiliary contacts and main contacts				V AC	440	440	440	440
Switching angle				$^{\circ}$	90	90	90	90
Contacts				Qty.	max. 3 (+N)	max. 3 (+N)	max. 3 (+N)	max. 3 (+N)
Current heat loss per contact at I_e				W	8	10	13	16
Terminal capacity								
Solid or stranded				mm^2	1 \times (10 – 95) 2 \times (10 – 35)	1 \times (10 – 95) 2 \times (10 – 35)	1 \times (16 – 185) 2 \times (16 – 70)	1 \times (16 – 185) 2 \times (16 – 70)
Terminal capacity Flexible with ferrule to DIN 46228				mm^2	1 \times (16 – 70) 2 \times (16 – 25)	1 \times (16 – 70) 2 \times (16 – 25)	1 \times (25 – 120) 2 \times (25 – 50)	1 \times (25 – 120) 2 \times (25 – 50)
Terminal screw					Allen screw 5	Allen screw 5	Allen screw 6	Allen screw 6
Tightening torque				Nm	14	14	16	16

Notes Main switch characteristics to IEC/EN 60204; positive opening of contacts, operator element positively located on shaft
The rated uninterrupted current I_u is given at max. connected cross-section.
For terminal capacity solid, stranded and flexible:
Max. 2 cross-section sizes difference admissible when using 2 conductors.

Moeller HPL0211-2004/2005

				P5-125	P5-160	P5-250	P5-315	
Switching capacity								
AC								
Rated making capacity $\cos \varphi = 0.35$		A		850	1050	1700	2050	
Rated breaking capacity	230 V	A		800	900	1600	1800	
Motor load switches $\cos \varphi = 0.35$	400/415 V	A		750	850	1380	1650	
	500 V	A		650	850	1250	1550	
	690 V	A		340	340	400	400	
Rated operational current	440 V	I_e	A	125	160	250	315	
Load-break switches AC-21A								
Rated power	230 V	P	kW	22	30	37	45	
Motor load switches AC-3	400/415 V	P	kW	37	45	55	75	
	690 V	P	kW	30	37	45	45	
Rated power	230 V	P	kW	30	30	37	55	
Motor load switches AC-23A	400/415 V	P	kW	45	55	90	110	
	690 V	P	kW	37	37	45	45	
DC								
DC-1, Load-break switches L/R = 1 ms	Rated operational current	I_e	A	125	160	250	315	
	Voltage per contact pair in series		V	42	42	42	42	
DC-23A, Motor load switches L/R = 15 ms	24 V	Rated operational current	I_e	A	125	160	250	315
		Contacts		Qty.	3	3	3	3
	48 V	Rated operational current	I_e	A	125	160	250	315
		Contacts		Qty.	3	3	3	3
	60 V	Rated operational current	I_e	A	125	160	250	315
		Contacts		Qty.	3	3	3	3
120 V	Rated operational current	I_e	A	40	50	80	100	
	Contacts		Qty.	3	3	3	3	

Notes Main switch characteristics to IEC/EN 60204; positive opening of contacts, operator element positively located on shaft
The rated uninterrupted current I_u is given at max. connected cross-section.
For terminal capacity solid, stranded and flexible:
Max. 2 cross-section sizes difference admissible when using 2 conductors.



				HI...-P1(P3)...	HI...-P5...
Auxiliary contacts					
Standards				Control circuit isolators to IEC/EN 60947-5 ☺	
Rated insulation voltage	U_i	V AC		500	500
Rated uninterrupted current	I_u	A		10	10
Rated operational current					
AC-15					
230 V	I_e	A		6	6
400/415 V	I_e	A		–	3
DC-13					
125 V	I_e	A		1.1	0.23
250 V	I_e	A		0.55	0.1
Short-circuit rating					
Max. fuse		A gG/gL		10	10
Terminal capacity					
Solid		mm ²		0.75 – 2.5	0.75 – 2.5
Flexible with ferrule to DIN 46228		mm ²		0.5 – 1.5	0.5 – 2.5
Tightening torque		Nm		0.6	0.8
Control circuit reliability at 24 V DC, 10 mA		Fault probability	H_f	< 10^{-5} , < 1 fault in 100 000 operations	

TM mini rotary switches

General technical data

Standards			IEC/EN 60947, VDE 0660 UL, CSA Control switches to IEC/EN 60 947-5-1 Control circuit isolators to IEC/EN 60947-5-1
Control circuit isolators (IEC/EN 60947-5-1)			Maximum of 6 contacts; switching angle 90°
Lifespan, mechanical	Operations	× 610	>1
Maximum operating frequency	Operations/h		3000
Climatic proofing			Damp heat, constant, to IEC 60068-2-78; Damp heat, cyclical, to IEC 60068-2-30
Ambient temperature			
Open		°C	-25/+50
Enclosed		°C	-25/+40
Mounting position			As required
Terminal capacity			
Solid		mm ²	1 × 1.5 2 × 1.5
Flexible without ferrule		mm ²	1 × 1.5 2 × 1.5
Solid or stranded		AWG	1 × 14 2 × 14
Flexible		AWG	1 × 16 2 × 16
Terminal screw			M2.5
Tightening torque		Nm	0.35

Contacts

Mechanical variables			
Contacts		Qty.	max. 16
Contact units			max.8
Switching angle		°	90 60 45 30
Smallest switching angle for On-Off-On		°	60
Max. number of switch positions			≤12
Thickness of gold coating		μm	35

Electrical characteristics

Rated operational voltage	U_e	V AC	500
Rated impulse withstand voltage	U_{imp}	V AC	4000
Overvoltage category/pollution degree			III/3
Rated insulation voltage	U_i	V AC	500
Rated insulation voltage for UL/CSA			300
Rated uninterrupted current	I_u	A	10

Switching capacity

AC-23 Motor load switches	230 V AC, 3-pole		kW	1.8
	440 V AC, 3-pole		kW	3
	230 V AC, 1-pole		kW	0.75
	440 V AC, 1-pole		kW	1.1
AC-15 control switches	230 V AC, 1-pole		A	2.5
	400/415 V AC, 1-pole		A	1.5
	440 V AC, 1-pole		A	1
DC-1 Load-break switches	1 – 24 V DC		A	10
	110 – 240 V DC		A	0.7 – 0.3
DC-13, control switches L/R = 50 ms	Rated operational current	I_e	A	3
	Voltage per contact pair in series		V	32
Switching capacity for North America	240 V AC, 3-pole		HP	1
	277 V AC, 1-pole		HP	¾
	300 V AC Heavy duty		A	10

Max. short-circuit protective device

Fuse			A gG/gL	10
Control circuit reliability at 24 V DC, 10 mA	Fault probability	H_f	< 10 ⁻⁵ , < 1 fault in 100000 operations	

Moeller HPL0211-2004/2005

Flush mounting

T0.../E (+ H3-T0)
T3.../E (+ H3-T0)

Drilling dimensions

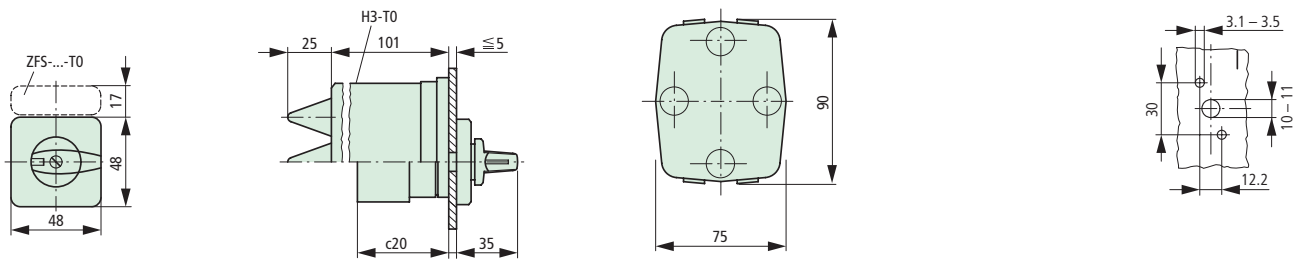

Centre mounting

T0.../EZ
T3.../EZ

T0

T3

Drilling dimensions

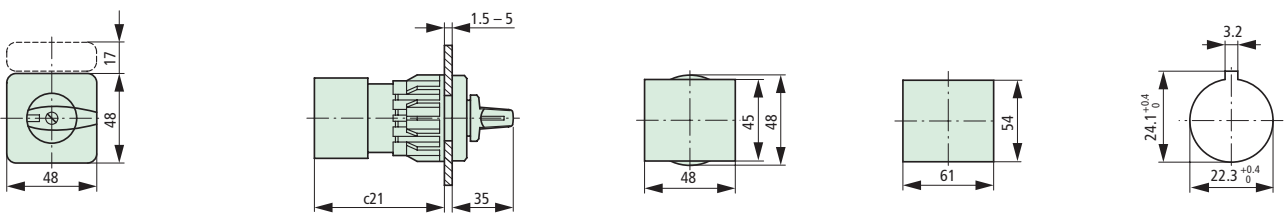

Type	c20	c21
T0-1...	41	61
T0-2...	50	70
T0-3...	60	80
T0-4...	69	89
T0-5...	79	99
T0-6...	88	108
T0-7...	98	118
T0-8...	107	127
T0-9...	117	137
T0-10...	126	146
T0-11...	136	156

Depth of one contact unit: 9.5 mm

Type	c20	c21
T3-1...	44	64
T3-2...	56	76
T3-3...	67	87
T3-4...	79	99
T3-5...	90	110
T3-6...	102	122
T3-7...	113	133
T3-8...	125	145
T3-9...	136	156
T3-10...	148	168
T3-11...	159	179

Depth of one contact unit: 11.5 mm



Service distribution board mounting

T0.../IVS

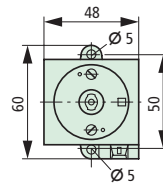
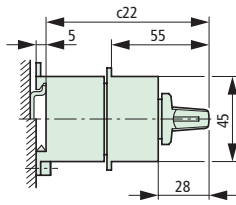
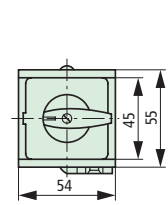

Drilling dimensions
Base



Rear mounting

T0.../Z
T3.../Z

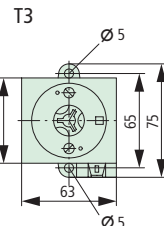
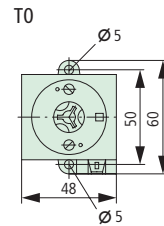
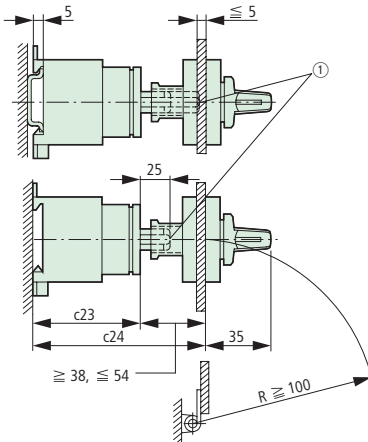
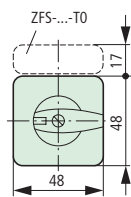

Drilling dimensions
Base

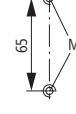
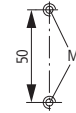

Drilling dimensions
Door

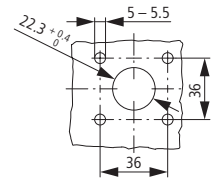
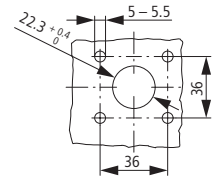

① Can be extended using ZAV-T0,
≧ 4 × 25 = 100 mm

Type	c20	c21	c22	c23	c24 ≧/≦	c24 with ≧ 4 ZAV	c25
T0-1...	41	61	77	48	86 - 102	202	72
T0-2...	50	70	87	57	96 - 112	212	72
T0-3...	60	80	96	67	105 - 121	221	91
T0-4...	69	89	106	76	115 - 131	231	91
T0-5...	79	99	115	86	124 - 140	240	-
T0-6...	88	108	125	95	134 - 150	250	-
T0-7...	98	118	134	105	143 - 159	259	-
T0-8...	107	127	144	114	153 - 169	269	-
T0-9...	117	137	154	124	162 - 178	278	-
T0-10...	126	146	163	133	172 - 188	288	-
T0-11...	136	156	173	143	181 - 197	297	-

Depth of one contact unit: 9.5 mm

Type	c20	c21	c22	c23	c24 ≧/≦	c24 with ≧ 4 ZAV	c25
T3-1...	44	64	80	51	86 - 105	205	79
T3-2...	56	76	92	63	101 - 115	216	79
T3-3...	67	87	103	74	112 - 128	228	101
T3-4...	79	99	115	86	124 - 139	239	101
T3-5...	90	110	126	97	135 - 151	251	-
T3-6...	102	122	138	109	147 - 162	262	-
T3-7...	113	133	149	120	158 - 174	274	-
T3-8...	125	145	161	132	170 - 185	285	-
T3-9...	136	156	172	143	181 - 196	296	-
T3-10...	148	168	184	155	193 - 208	308	-
T3-11...	159	179	195	166	204 - 219	319	-

Depth of one contact unit: 11.5 mm

Moeller HPL0211-2004/2005

Flush mounting main switches

T0.../EA/SVB
T3.../EA/SVB

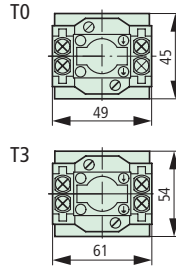
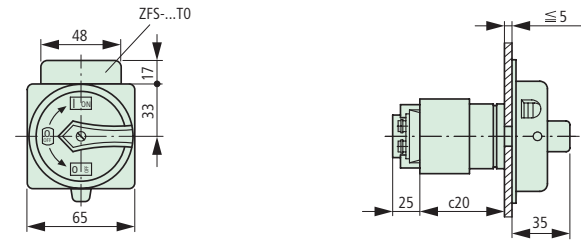

Drilling dimensions
Door

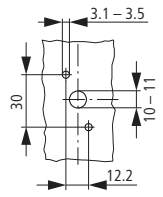

Rear mounting main switches

T0.../V/SVB
T3.../V/SVB

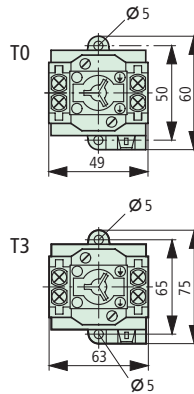
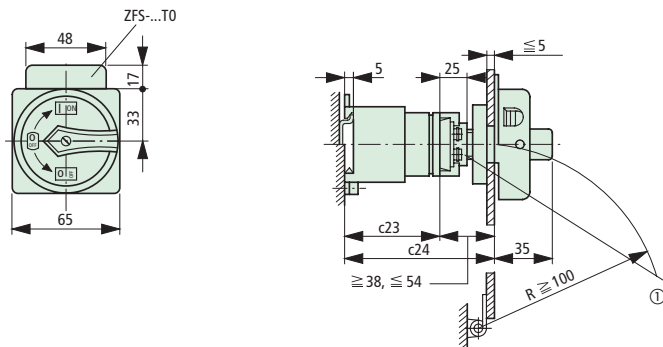

Drilling dimensions
Base



Drilling dimensions
Door

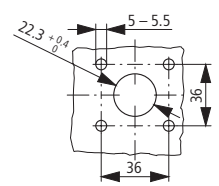

① Interlock can be extended using ZVV-T0 + ZAV-T0, ≅ 4 × 25 = 100 mm

Rotary Switches, Switch-Disconnectors



Surface mounting

T0.../11

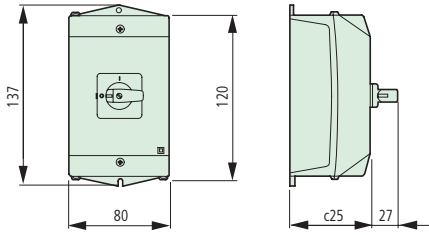

Drilling dimensions
Base

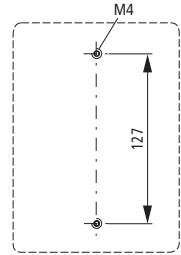

T3.../12

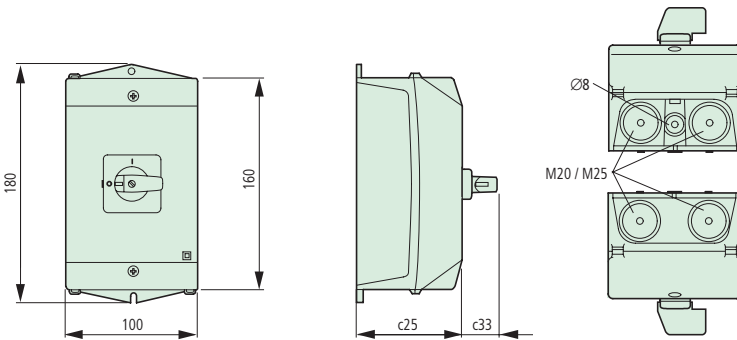

Drilling dimensions
Base

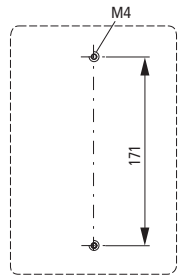

Surface mounting main switches

T0.../11/SVB

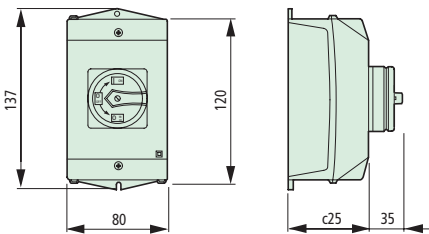

Drilling dimensions
Base

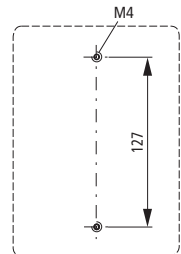

T3.../12/SVB

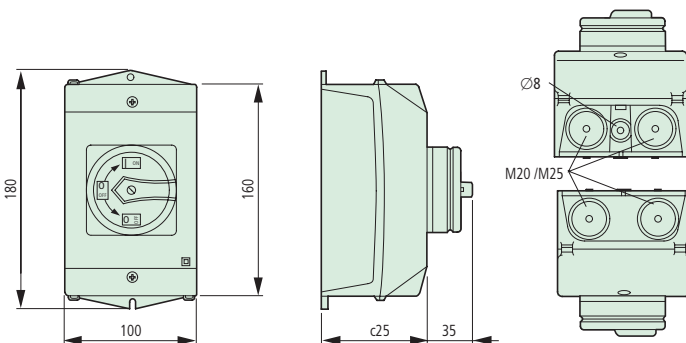

Drilling dimensions
Base

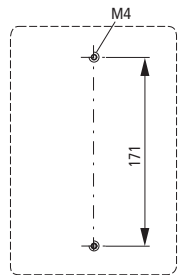
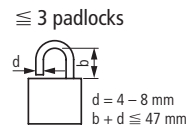

Type	c25
T0-1...	75
T0-2...	75
T0-3...	95
T0-4...	95

Type	c25	c33
T3-1...	80	27
T3-2...	80	27
T3-3...	100	35
T3-4...	100	35
T3-5...	145	35

T0, T3 Rotary Switches, P1, P3 Switch-Disconnectors, Accessories

Moeller HPL0211-2004/2005

Key operated lock mechanism

S-T0
S-SOND...-T0

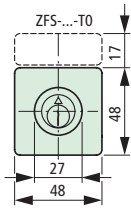

T0.../E(I1) + S-(SOND-)T0
T3.../E(I2) + S-(SOND-)T0

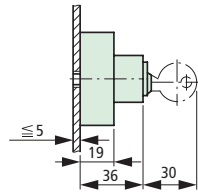

T0.../Z + S-(SOND-)T0
T3.../Z + S-(SOND-)T0

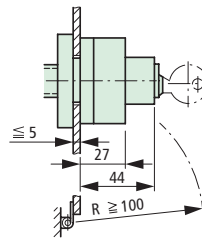

T0.../EZ Δ T0.../E + EZ-T0 + S-(SOND-)T0
T3.../EZ Δ T3.../E + EZ-T0 + S-(SOND-)T0

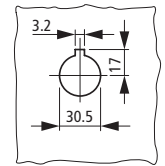
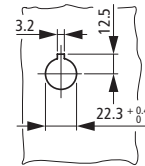
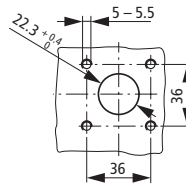
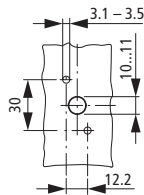
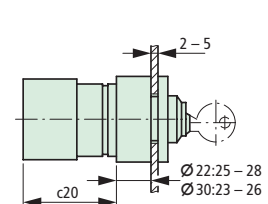

Cylinder lock

SVA-T3

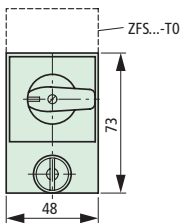

T0.../I1/SVA
T3.../I2/SVA
P1.../I2/SVA

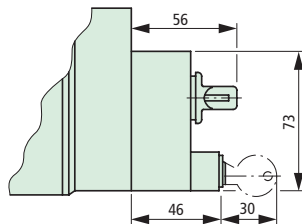

T0.../E/SVA...
T3.../E/SVA...
P1.../E/SVA

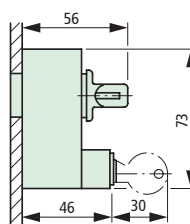

T0.../Z/SVA...
T3.../Z/SVA...
P1.../Z/SVA

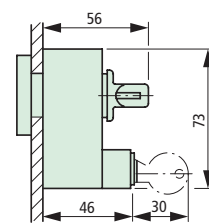

SVC-T3 padlocking feature

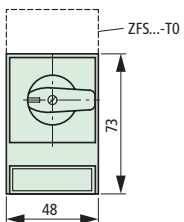

T0.../I1/SVC
T3.../I2/SVC
P1.../I2/SVC

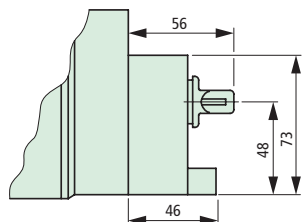

T0.../E/SVC...
T3.../E/SVC...
P1.../E/SVC

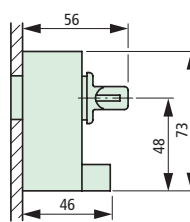

T0.../Z/SVC...
T3.../Z/SVC...
P1.../Z/SVC

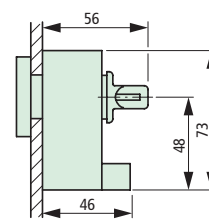

Modules

Switched neutral: N-P...
Auxiliary contacts: HI 11-P1/P3

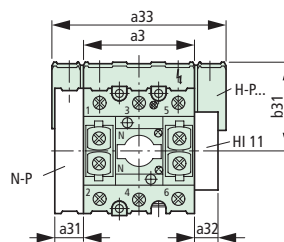
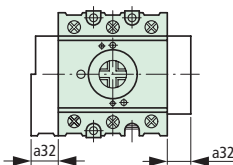
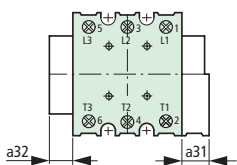

≅ 3 padlocks

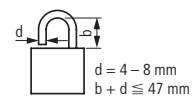

Type	a3	a31	a32	a33	b31
P1-...	49	15	15	83	49
P3-..	72	18	15	114	60



Flush mounting
T5(B).../E



Drilling dimensions
Door

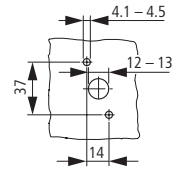

Rear mounting
T5(B).../Z

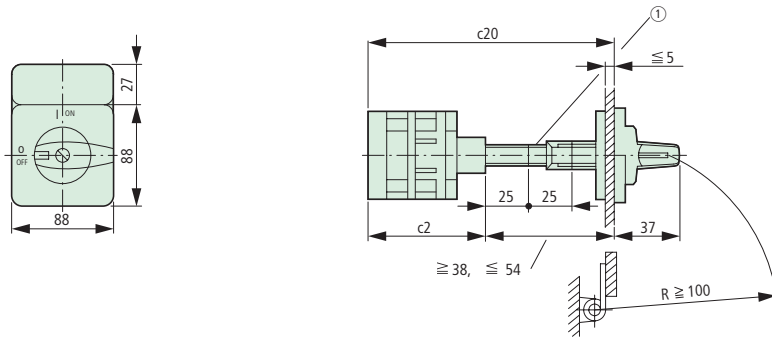

Drilling dimensions
Base

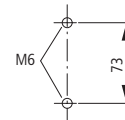

Drilling dimensions
Door

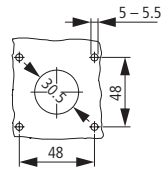

① Shaft can be extended using ZAV-P3 $\cong 4 \times 25 = 100$ mm

Flush mounting main switches
T5(B).../EA/SVB

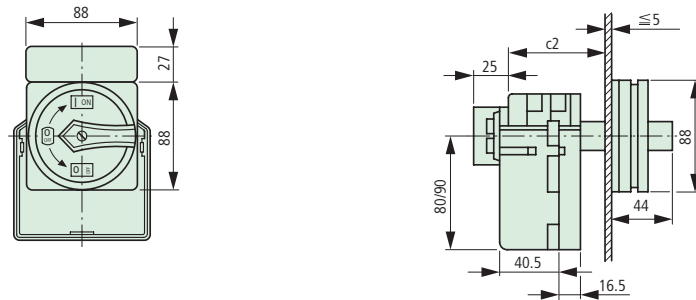

Drilling dimensions
Door

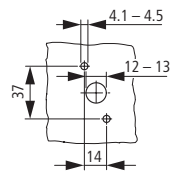

Rear mounting main switches
T5(B).../V/SVB

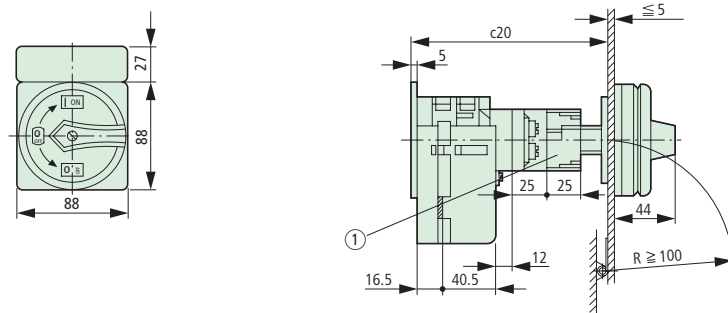

Drilling dimensions
Base

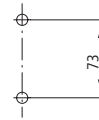

Drilling dimensions
Door

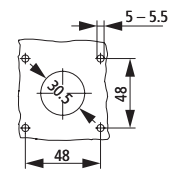

Type	c2	c20 \cong/\leq	c20 with $\cong 4$ ZAV	c21	c22
T5(B)-1...	54	92 - 107	207	90	125 (95)
T5(B)-2...	71	109 - 124	224	90	125 (95)
T5(B)-3...	87	125 - 140	240	123	160 (160)
T5(B)-4...	104	142 - 157	257	123	160 (160)
T5(B)-5...	120	158 - 173	273	-	-
T5(B)-6...	137	175 - 190	290	-	-
T5(B)-7...	153	191 - 206	306	-	-
T5(B)-8...	170	208 - 223	323	-	-
T5(B)-9...	186	224 - 239	339	-	-
T5(B)-10...	203	240 - 356	356	-	-

Depth of one contact unit: 16.5 mm

① Can be extended using ZVV-P3, $\cong 4 \times 25 = 100$ mm

Rotary switches T5B and T5 are of identical design but differ in their contacts

Moeller HPL0211-2004/2005

Surface mounting

T5(B).../14

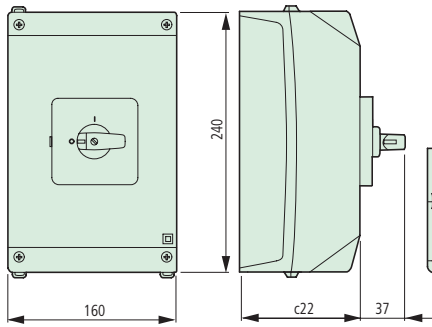

T5.../15

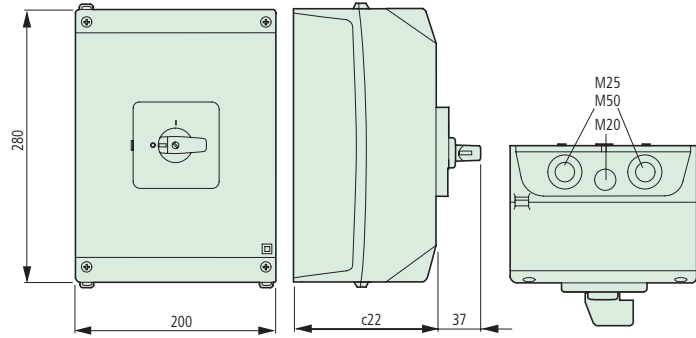

Surface Mounting Main Switches

T5(B).../14/SVB

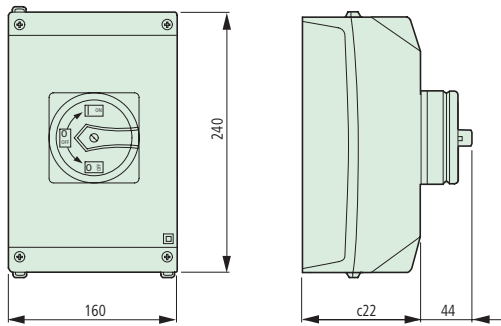

Drilling dimensions

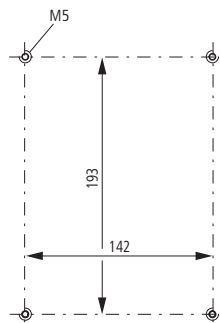

≧ 3 padlocks

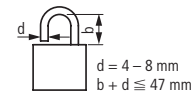

T5.../15/SVB

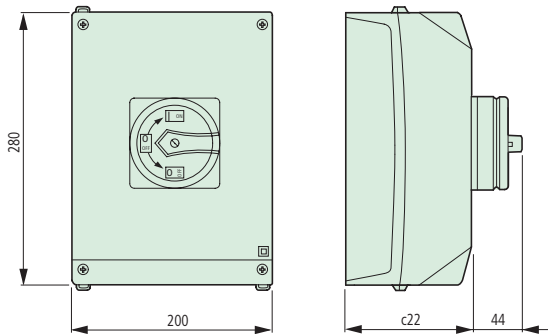

Drilling dimensions

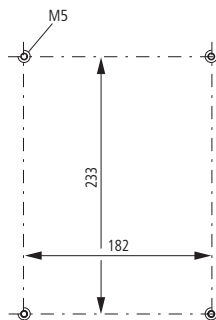

External fixing bracket

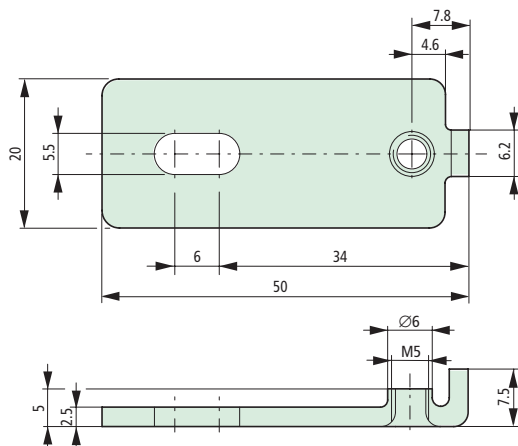

Type	c22
T5(B)-1...	125 (95)
T5(B)-2...	125 (95)
T5(B)-3...	160 (160)
T5(B)-4...	160 (160)

Depth of one contact unit: 16.5 mm

Rotary switches T5B and T5 are of identical design but differ in their contacts

Flush mounting

T6.../E/HI12
T8.../E/HI12

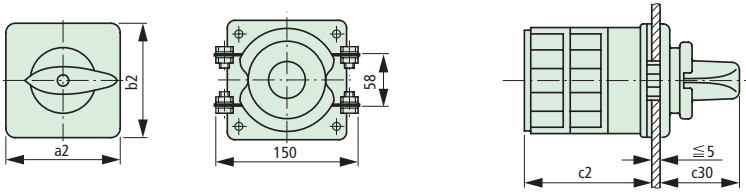

T6-160-6/V/SVB-SW/HI11

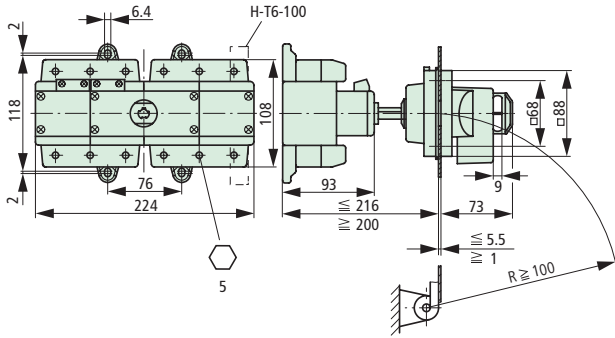

T8-3-8342/V/SVB-SW/HI11

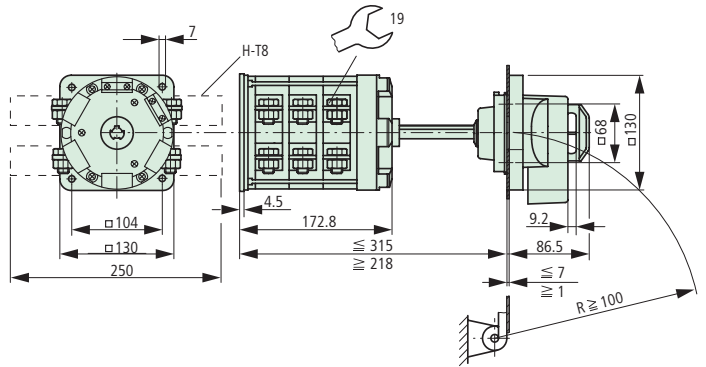

Type	a2	b2	c2	2 BE	3 BE	c30	d1	d2	x1	y1
T6...	88	88		100	152	44	∅ 26-30	∅ 6.0	68	68
T8.../E	130	130		-	173	62	∅ 22-25	∅ 7.0	104	104
T8.../SVB	-	-		-	-	-	∅ 38-42	∅ 7.0	68	68

BE = Number of contact units

Drilling dimensions
Door

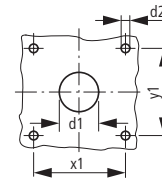

T6: 4 M5 × 20
T8: 4 M6 × 20

≅ 3 padlocks for T.../SVB

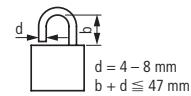

Moeller HPL0211-2004/2005

Flush mounting

Centre mounting

P.../E

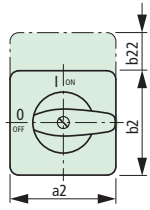

P1.../EZ

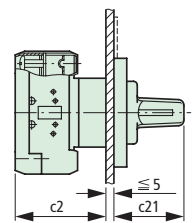
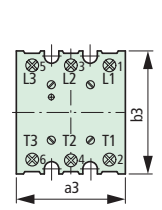

P1.../EZ = c2 + 5 mm

Drilling dimensions

Door
P1.../E

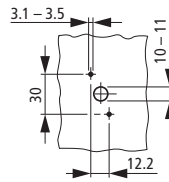

P1.../EZ

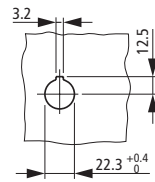

P3.../E

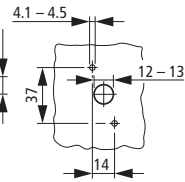

Service distribution board mounting

P3.../IVS

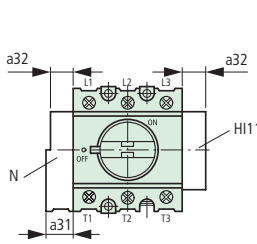
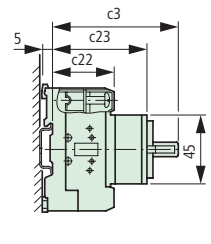
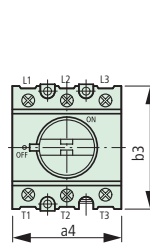

≅ 3 padlocks

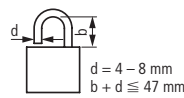

P1.../IVS

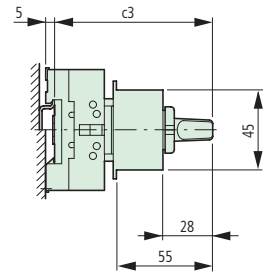
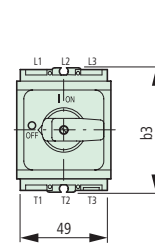

Rear mounting

P.../Z

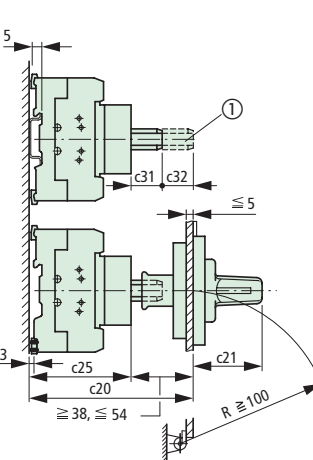
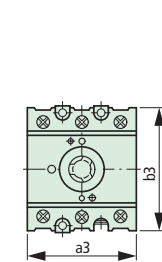
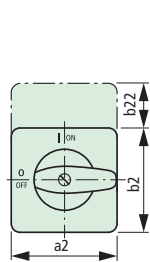

Drilling dimensions

Base
P1.../Z

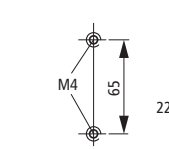

Drilling dimensions

Door

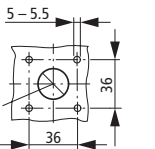

P3.../Z

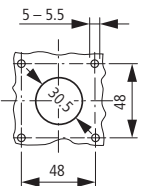
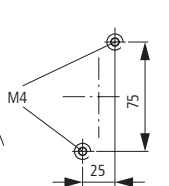

① Shaft can be extended using ZAV... ≅ 4 × 25 = 100 mm

Type	a2	a3	a4	a21	a22	a23	a31	a32	a33	b2	b3	b21	b22	b23	b24	b31
P1	48	49	53,5	65	48	87	15	15	83	48	70	65	17	180	32	49
P3	87	72	71.5	87	87	125	18	15	114	87	95	87	27	175	-	60

Type	c2	c3	c20 ≅/≅	c20 with ≅ 4 ZAV/ZVV	c21	c22	c23	c24	c25	c27	c28	c31	c32	c33
P1	59	86	96 - 112	212	35	32	65	68	58	35	77	25	25	27
P3	65	82	103 - 118	218	37	41	63	81	65	44	90	25	25	29

Flush mounting main switches

P.../EA/SVB

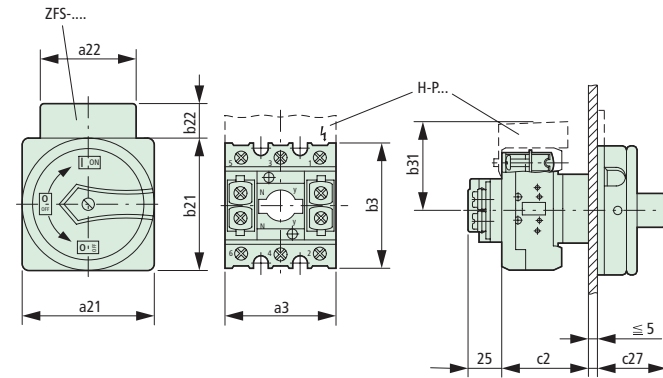

Drilling dimensions
Door

P1...

P3...

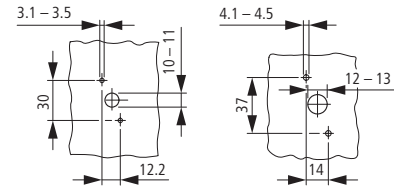

Rear mounting main switches

P.../V/SVB

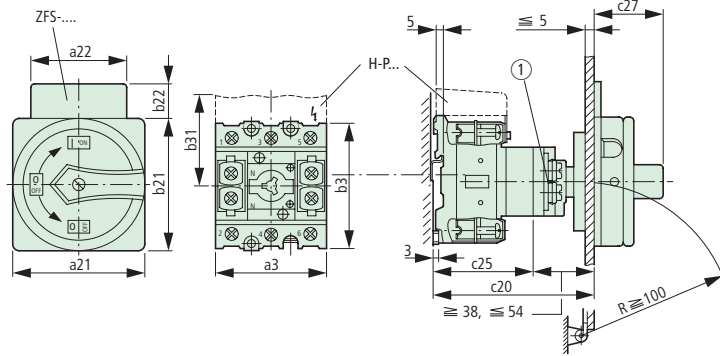

Drilling dimensions
Base

Drilling dimensions
Door

P1.../V/SVB

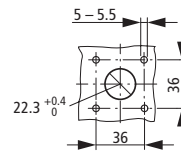
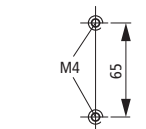

P3.../V/SVB

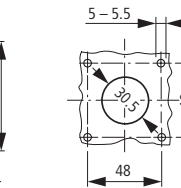
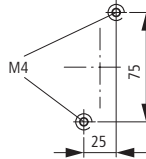

① Interlock can be extended using ZVV-... + ZAV-..., ≅ 4 × 25 = 100 mm

Surface mounting

Surface mounting main switches/Safety switches

P1.../I2

P1.../I2/SVB
P1.../I2/SI

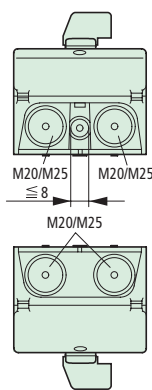
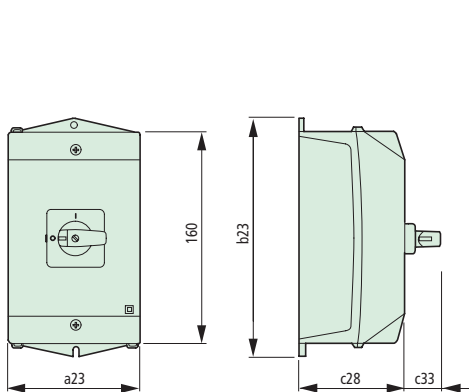

Drilling dimensions

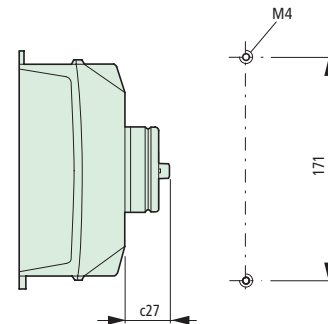

Type	a2	a3	a4	a21	a22	a23	a31	a32	a33	b2	b3	b21	b22	b23	b24	b31
P1.../I2	48	49	53,5	65	48	100	15	15	83	48	70	65	17	180	35,5	49

Type	c2	c3	c20 ≅/≅	c20 with ≅ 4 ZAV/ZVV	c21	c22	c23	c24	c25	c27	c28	c31	c32	c33
P1...	59	86	96-112	212	35	32	65	68	58	35	80	25	25	27

Moeller HPL0211-2004/2005

Flush mounting

P5.../E

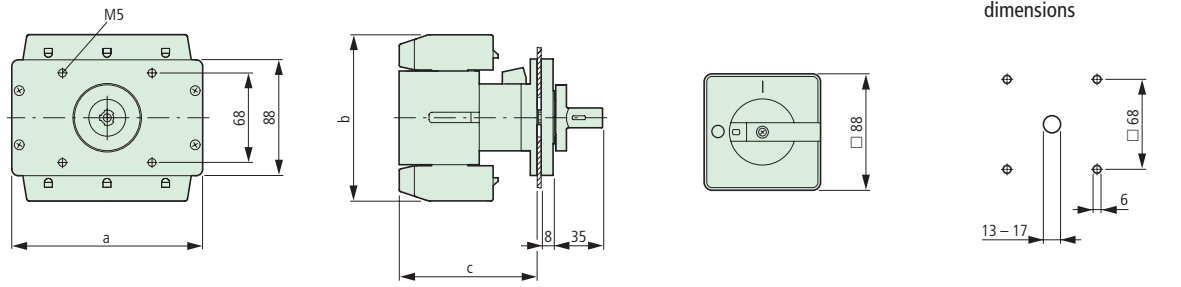

Flush mounting main switches

P5.../EA/SVB(-SW)

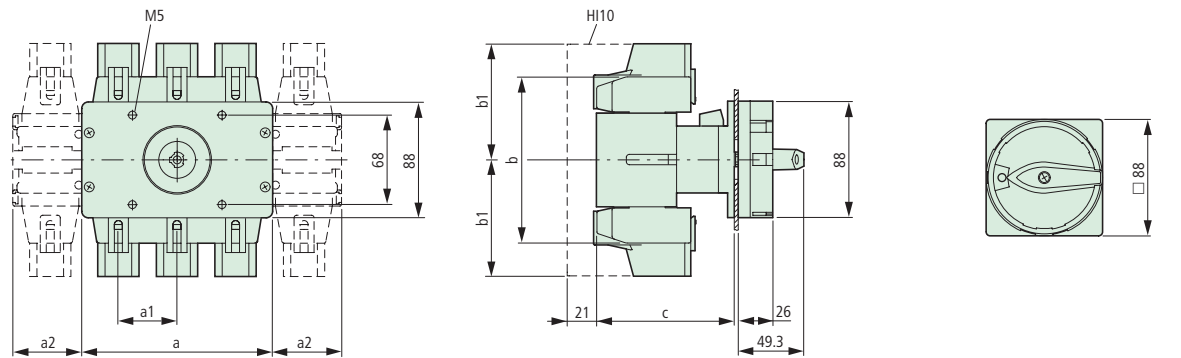

Rear mounting

P5.../Z

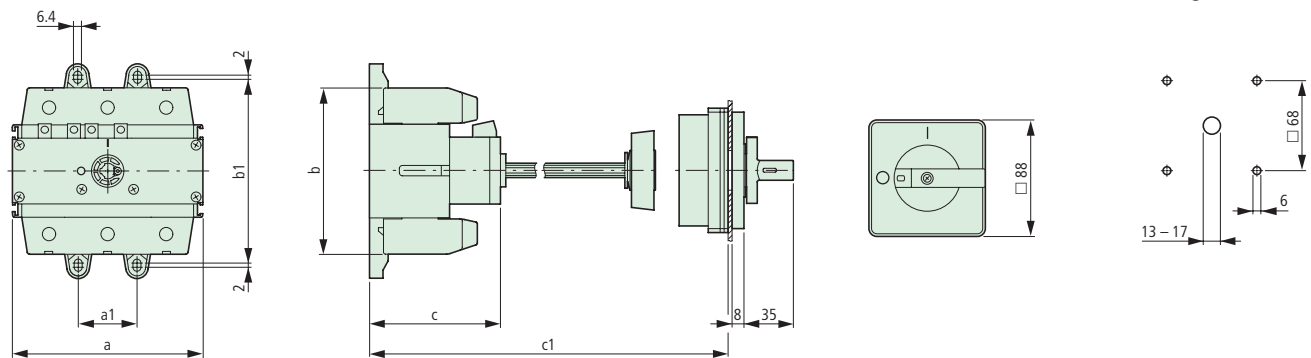

Rear mounting main switches

P5.../V/SVB(-SW)

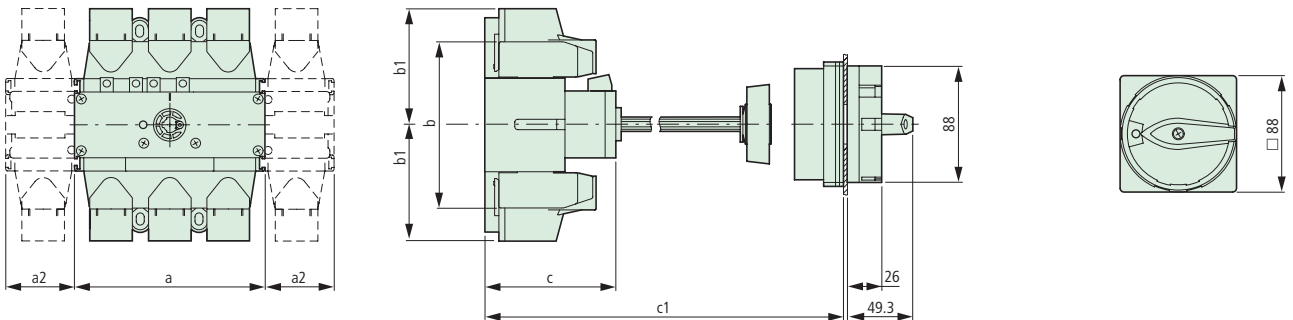

Type	a	a1	a2	b	b1	c	c1
P5-125/160	112	36	38	108	76	91	≅ 287
P5-250/315	145	44	52.5	126	88	98	≅ 280



Surface mounting
P3-63/14

Surface mounting main switches/Safety switches
P3-63/14/SVB
P3-63/14/SI
T5B-.../14/SI

Drilling dimensions

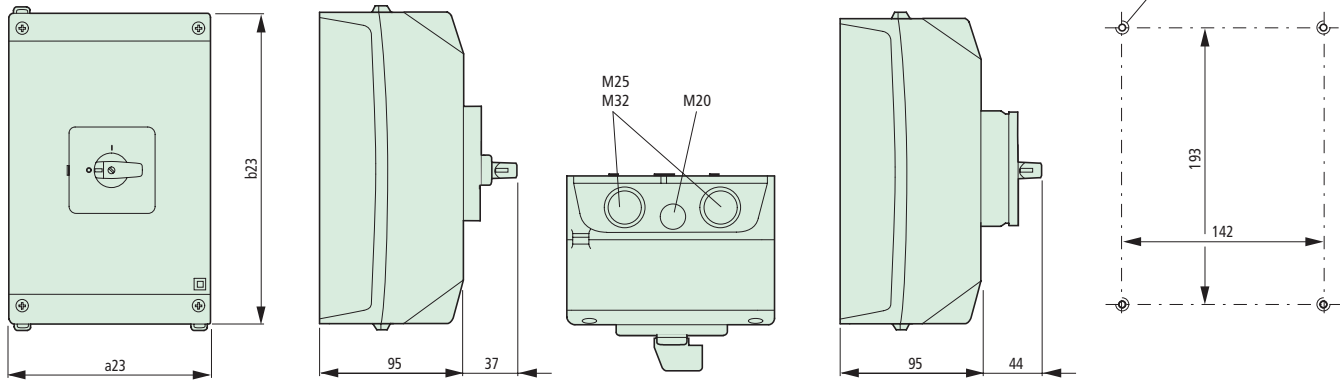

Surface mounting

P3-100/15

Surface mounting main switches/Safety switches
P3-100/15/SVB
P3-100/15/SI
T5-.../15/SI

Drilling dimensions

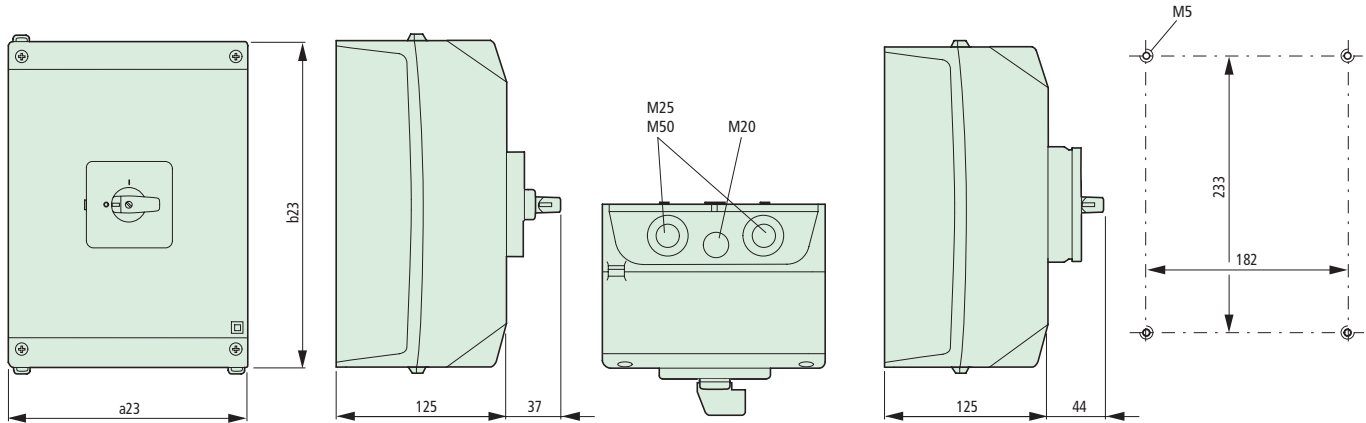

Type	a2	a3	a4	a21	a22	a23	a31	a32	a33	b2	b3	b21	b22	b23	b24	b31
P3-63/14	87	72	71.5	87	87	160	18	15	114	87	83	87	27	240	35,5	60
P3-100/15	87	72	71.5	87	87	200	18	15	114	87	83	87	27	280	35,5	60

Type	c2	c3	c20 ≧/≦	c20 with ≦ 4 ZAV/ZVV	c21	c22	c23	c24	c25	c27	c28	c31	c32	c33
P3-63	59	82	103 – 118	218	37	41	63	81	65	44	125	25	25	37
P3-100	59	82	103 – 118	218	37	41	63	81	65	44	125	25	25	37

Moeller HPL0211-2004/2005

Flush mounting

TM.../E

Drilling dimensions

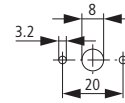
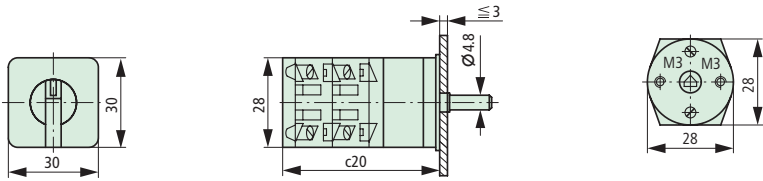

Control circuit isolators

For 2 padlocks Ø 4 mm or 1 padlock Ø 6 mm

TM.../E/SVB(-SW)

Drilling dimensions

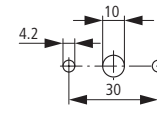
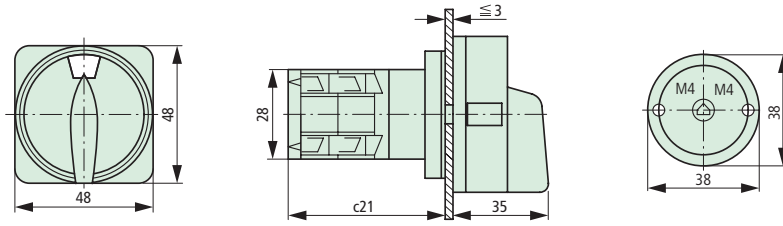

Centre mounting

TM-.../EZ

Drilling dimensions¹⁾

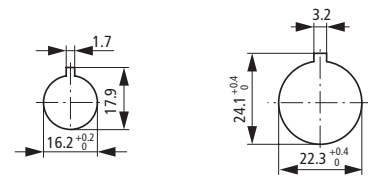
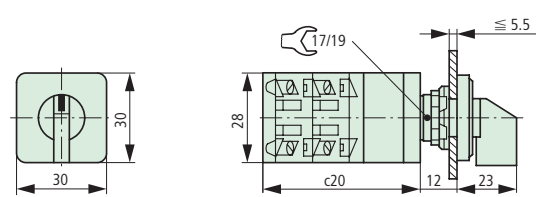

Centre mounting with key operation

TM-...+EZ/S-...

Drilling dimensions¹⁾

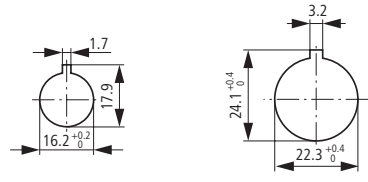
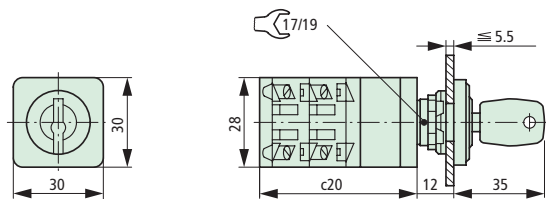

Type	c20	c21
TM-1...	39	42
TM-2...	51	54
TM-3...	63	66
TM-4...	75	
TM-5...	87	
TM-6...	99	
TM-7...	111	
TM-8...	123	

Depth of one contact unit: 12 mm

Service distribution board mounting

TM-.../IVS

TM-.../IVS/S

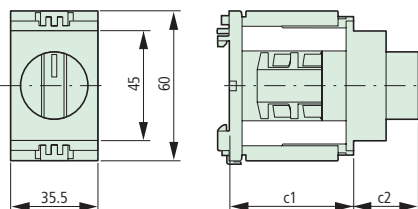

Type	C1	C2
TM-1...	44	21
TM-2...	46	26,5

Depth of one contact unit: 12 mm

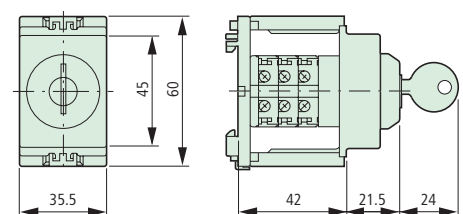

Notes

¹⁾ Drilling dimensions as required: 16.2 mm = without reduction ≙ RMQ16; 22.3 mm = with reduction ≙ RMQ-Titan