

HALOPAR 30 75 W 230 V 30° E27

OSRAM HALOPAR 30 | Halogen lamps with parabolic reflector PAR30, with screw base



Areas of application

- General illumination
- Workplace lighting
- Kitchen lighting
- Object lighting
- Accent lighting
- Shops
- Restaurants, hotels and similar prestigious applications

Product benefits

- Brilliant accent light
- With whole glass reflector for brilliant lighting effects
- Instant 100 % light, no warm-up time
- Approved for use in open luminaires (to IEC 60598-1)
- Contains no mercury
- UV filter

Product features

- Average life: 2,000 h
- 100 % dimmable
- Perfect color rendering ($R_a: 100$)
- Color temperature: 2,900 K

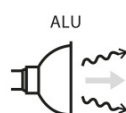
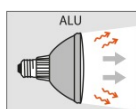

Product datasheet

Technical data

Electrical data

Nominal wattage	75.00 W
Nominal voltage	230 V
Rated wattage	75.00 W
Power factor λ	1.00

Photometrical data

Nominal useful luminous flux 90°	650 lm
Luminous intensity	2200 cd
Color temperature	2900 K
Light color as per EN 12464-1	Warm White
Color rendering index Ra	100
Lumen main.fact.at end of nom.life time	0.75
Rated useful luminous flux 90°	650 lm

Light technical data

Beam angle	30 °
Starting time	0.0 s
Warm-up time (60 %)	0.00 s

Dimensions & weight

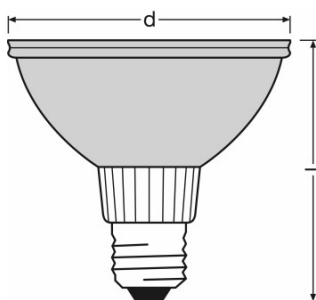

Diameter	97.0 mm
Length	90.5 mm
Overall length	90.5 mm
Outer bulb	PAR95
Maximum diameter	97.0 mm

Product datasheet

Lifespan

Nominal lamp life time	2000 h
Rated lamp life time	2000 h
Number of switching cycles	50000 ¹⁾

¹⁾ At 1 min on / 3 min off

Additional product data

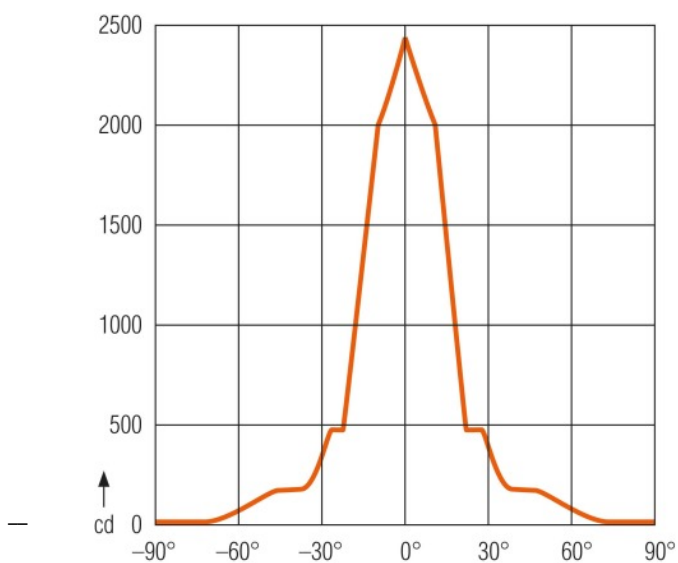

Luminous intensity distribution

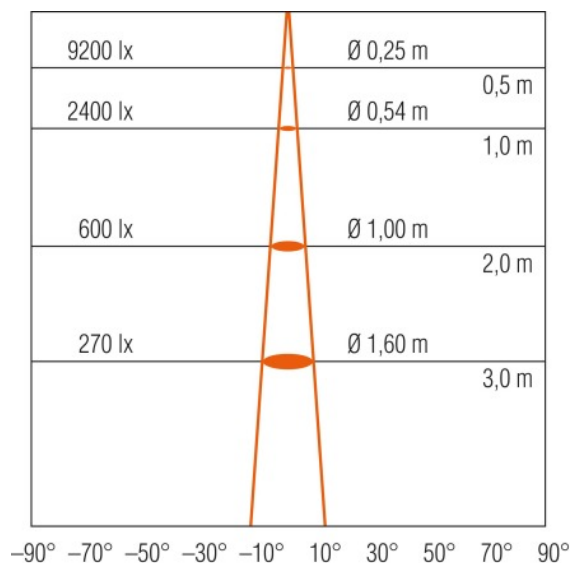

Luminous intensity distribution

Product datasheet

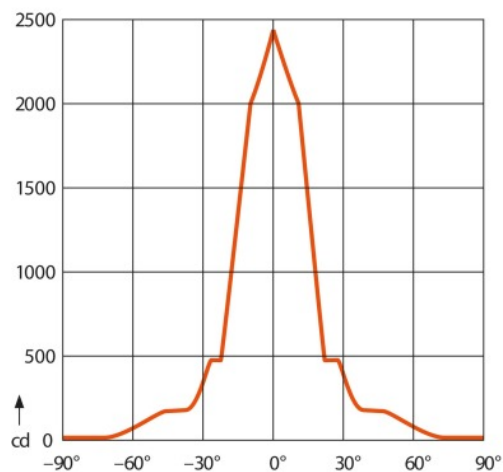

64845 FL
64841 FL: /·8%

Luminous intensity distribution

Base (standard designation)	E27
Lamp mercury content	0.0 mg
Mercury-free	Yes
Footnote only for product	Not suitable for outdoor use or damp conditions

Capabilities

Burning position	Any
Dimmable	Yes

Certificates & standards

Energy efficiency class	D
Energy consumption	75 kWh/1000h

Country specific categorizations

ILCOS	HAGS/UB-75-240-E27-97/30
Order reference	64841 FL 75W 23

Light Distribution

Product datasheet

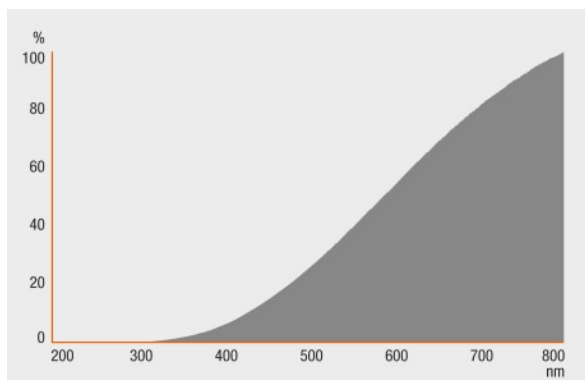

Spectral power distribution

Logistical Data

Product code	Product description	Packaging unit (Pieces/Unit)	Dimensions (height x width x length)	Volume	Gross weight
4050300338491	HALOPAR 30 75 W 230 V 30° E27	Shipping carton box 15	336 mm x 172 mm x 521 mm	30.11 dm ³	3540.00 g

The mentioned product code describes the smallest quantity unit which can be ordered. One shipping unit can contain one or more single products. When placing an order, for the quantity please enter single or multiples of a shipping unit.

References / Links

For light distribution curves see

- ▶ www.osram.com

Disclaimer

Subject to change without notice. Errors and omission excepted. Always make sure to use the most recent release.