

Box mounting receptacle KPTC2

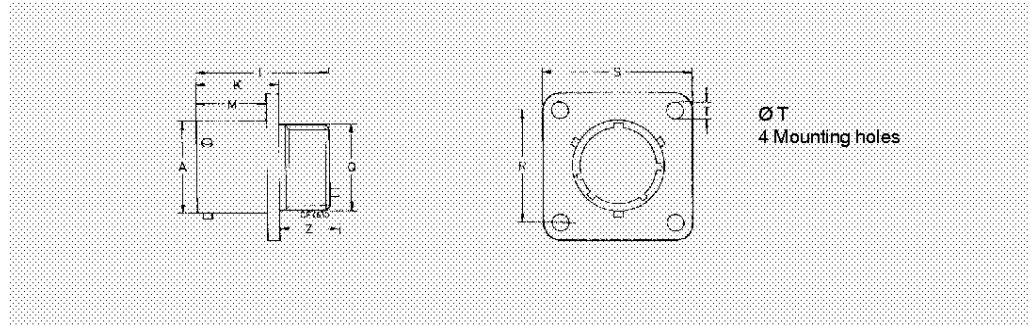
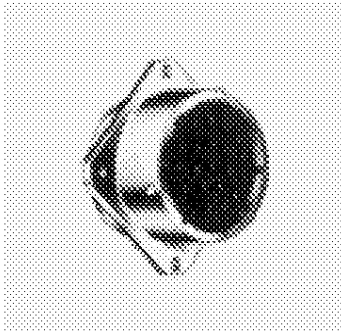

without endbell

Dimensions are mm

Shell size*	Ø A	L	N Ø	K	M	R	S	ØT	Z
	+0,03-0,13	max.	max.	±0,25	±0,15	±0,15	max.	±0,15	max.
8	12,0	21,1	11,1	13,5	11,6	15,1	21,0	3,05	12,3
10	15,0	21,1	14,3	13,5	11,6	18,3	24,2	3,05	12,3
12	19,05	21,1	17,5	13,5	11,6	20,6	26,6	3,05	12,3
14	22,23	21,1	20,6	13,5	11,6	23,0	29,0	3,05	12,3
16	25,40	21,1	23,8	13,5	11,6	24,6	31,3	3,05	12,3
18	28,58	21,1	27,0	13,5	11,6	27,0	33,7	3,05	12,3
20	31,75	22,7	30,2	16,5	14,25	29,4	36,9	3,05	10,8
22	34,93	22,7	33,4	16,5	14,25	31,8	40,1	3,05	10,8
24	38,10	22,7	36,5	17,3	15,1	34,9	43,3	3,75	10,0

*) How to order see page 4

Dimensions are inches

Shell size*	A	L	N max	K	M	R	S	T	Z
	+ .001 - .005	max	max	± .010	± .006	± .006	max	± .006	max
8	.472	.831	.437	.531	.457	.594	.827	.120	.484
10	.591	.831	.563	.531	.457	.720	.953	.120	.484
12	.750	.831	.689	.531	.457	.811	1.047	.120	.484
14	.875	.831	.811	.531	.457	.906	1.142	.120	.484
16	1.000	.831	.937	.531	.457	.969	1.232	.120	.484
18	1.125	.831	1.063	.531	.457	1.063	1.327	.120	.484
20	1.250	.894	1.189	.650	.561	1.157	1.453	.120	.425
22	1.375	.894	1.315	.650	.561	1.252	1.579	.120	.425
24	1.500	.894	1.437	.681	.594	1.374	1.705	.148	.394

*) How to order see page 4

Wall mounting receptacle KPTC0

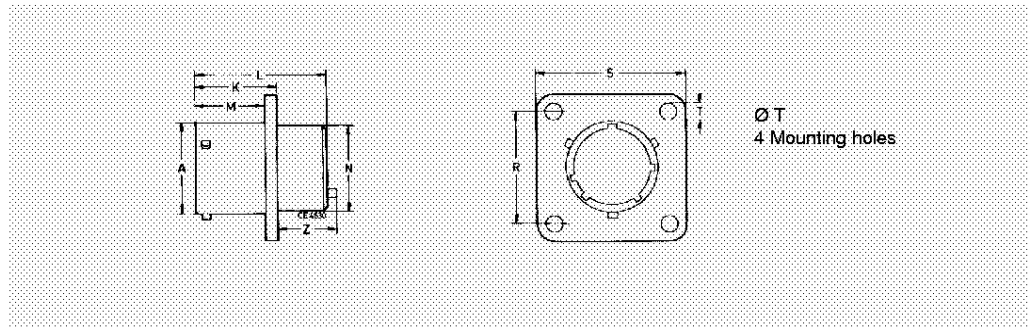
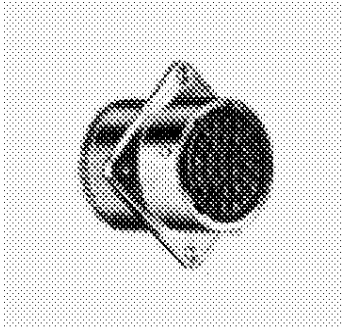

without endbell

Dimensions are mm

Shell size*	Ø A	L	Q	K	M	R	S	T Ø	Z
	+0,03	max	Thread Class 2A	±0,25	±0,15	±0,15	max.	±0,15	max.
8	12,00	21,6	7/16-28UNEF	13,5	11,6	15,1	21,0	3,05	12,3
10	15,00	21,6	9/16-24UNEF	13,5	11,6	18,3	24,2	3,05	12,3
12	19,05	21,6	1-1/16-24UNEF	13,5	11,6	20,6	26,6	3,05	12,3
14	22,3	21,6	1-3/16-20UNEF	13,5	11,6	23,0	29,0	3,05	12,3
16	25,40	21,6	1-5/16-20UNEF	13,5	11,6	24,6	31,3	3,05	12,3
18	28,58	21,6	1-1/16-18UNEF	13,5	11,6	27,0	33,7	3,05	12,3
20	31,75	26,8	1-3/16-18UNEF	16,5	14,25	29,4	36,9	3,05	10,8
22	34,93	26,8	1-5/16-18UNEF	16,5	14,25	31,8	40,1	3,05	10,8
24	38,10	26,8	1-7/16-18UNEF	17,3	15,1	34,9	43,3	3,75	10,0

*) How to order see page 4

Dimensions are inches

Shell size*	A	L	Q	K	M	R	S	T Æ	Z
	+0,01-0,05	max	Thread Type 2A	±0,10		±0,06	max	±0,06	max
8	.472	.850	7/16-28UNEF	.531	.457	.594	.827	.120	.484
10	.591	.850	9/16-24UNEF	.531	.457	.720	.953	.120	.484
12	.750	.850	1-1/16-24UNEF	.531	.457	.811	1.047	.120	.484
14	.875	.850	1-3/16-20UNEF	.531	.457	.906	1.142	.120	.484
16	1.000	.850	1-5/16-20UNEF	.531	.457	.969	1.232	.120	.484
18	1.125	.850	1-1/16-18UNEF	.531	.457	1.063	1.327	.120	.484
20	1.250	1.055	1-3/16-18UNEF	.650	.561	1.157	1.453	.120	.425
22	1.375	1.055	1-5/16-18UNEF	.650	.561	1.252	1.579	.120	.425
24	1.500	1.055	1-7/16-18UNEF	.681	.594	1.374	1.705	.148	.394

*) How to order see page 4

Wall mounting receptacle KPTC0

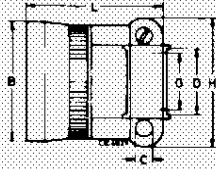

Type F

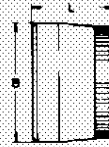

Type E

with endbell

Dimensions are mm

Shell size*	Type F						Type E	
	B _F max.	C Thread	D _F min.	G _F min.	H _F max.	L _F max.	B _E max.	L _E max.
8	14,0	6-32	6,0	2,9	19,3	45,1	14,2	34,0
10	17,2	6-32	5	4,5	20,8	45,1	17,2	34,0
12	20,4	6-32	10,7	7,7	24,4	45,1	20,4	34,0
14	23,6	6-32	13,9	9,3	27,2	45,1	23,4	34,0
16	26,7	6-32	15,5	12,4	28,7	48,2	26,6	34,0
18	29,5	8-32	19,6	15,6	35,3	48,2	29,6	34,0
20	32,7	8-32	19,6	15,6	35,3	50,0	32,8	36,0
22	35,9	8-32	23,6	18,8	39,9	50,0	36,0	36,0
24	39,0	8-32	25,2	20,1	43,2	50,0	39,2	36,0

*) How to order see page 4

Dimensions are inches

Shell size*	Type F					Type E		
	B _F max	C Thread	D _F min	G _F min	H _F max	L _F max	B _E max	L _E max
8	.551	6-32	.236	.114	.760	1.776	.559	1.339
10	.677	6-32	.295	.177	.819	1.776	.677	1.339
12	.803	6-32	.421	.303	.961	1.776	.803	1.339
14	.929	6-32	.547	.366	1.071	1.776	.921	1.339
16	1.051	6-32	.610	.488	1.130	1.898	1.047	1.339
18	1.161	8-32	.772	.614	1.390	1.898	1.165	1.339
20	1.287	8-32	.772	.614	1.390	1.969	1.291	1.417
22	1.413	8-32	.929	.740	1.571	1.969	1.417	1.417
24	1.535	8-32	.992	.791	1.701	1.969	1.543	1.417

*) How to order see page 4

Straight Plug KPTC6

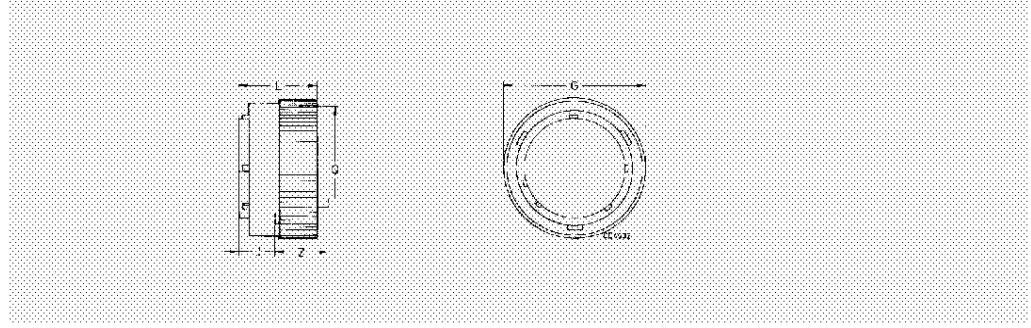
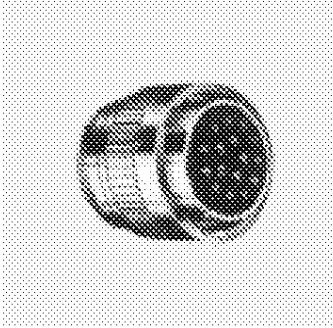

without endbell

Dimensions are mm

Shell size*	G max.	J ±0,15	L max.	Q Thread Class 2 A	Z max.
8	19,8	9,1	21,4	7/16-28UNEF	16,3
10	23,6	9,1	21,4	9/16-24UNEF	16,3
12	26,5	9,1	21,4	1-1/16-24UNEF	16,3
14	30,1	9,1	21,4	1-3/16-20UNEF	16,3
16	33,2	9,1	21,4	1-5/16-20UNEF	16,3
18	35,4	9,1	21,4	1-1/16-18UNEF	16,3
20	39,0	10,7	25,1	1-3/16-18UNEF	15,0
22	42,1	10,7	25,1	1-5/16-18UNEF	15,0
24	45,2	10,7	25,1	1-7/16-18UNEF	15,0

*) How to order see page 4

Dimensions are inches

Shell size*	G max	J ±.006	L max	Q Thread Type 2A	Z max
8	.780	.358	.843	7/16-28UNEF	.642
10	.929	.358	.843	9/16-24UNEF	.642
12	1.043	.358	.843	1-1/16-24UNEF	.642
14	1.185	.358	.843	1-3/16-20UNEF	.642
16	1.307	.358	.843	1-5/16-20UNEF	.642
18	1.394	.358	.843	1-1/16-18UNEF	.642
20	1.535	.421	.988	1-3/16-18UNEF	.591
22	1.657	.421	.988	1-5/16-18UNEF	.591
24	1.780	.421	.988	1-7/16-18UNEF	.591

*) How to order see page 4

Straight Plug KPTC6

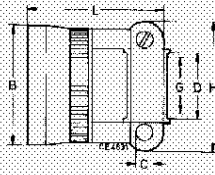

Type F

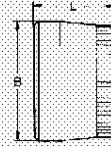

Type E

with endbell

Dimensions are mm

Shell size*	Type F						Type E	
	$\beta_F \varnothing$ max.	C Thread	$G_F \varnothing$ min.	G_F min.	H_F max.	L_F max.	β_E max.	L_E max.
8	14,0	6-32	6,0	2,9	19,3	46,0	14,2	32,5
10	17,2	6-32	7,5	4,5	20,8	46,0	17,2	32,5
12	20,4	6-32	10,7	7,7	24,4	46,0	20,4	32,5
14	23,6	6-32	13,9	9,3	27,2	46,0	23,4	32,5
16	26,7	6-32	15,5	12,4	28,7	49,0	26,5	32,5
18	29,5	8-32	19,6	15,6	35,3	49,0	29,6	32,5
20	32,7	8-32	19,6	15,6	35,3	49,0	32,8	34,5
22	35,9	8-32	23,6	18,8	39,9	49,0	36,0	34,5
24	39,0	8-32	25,2	20,1	43,2	49,0	39,2	34,5

*) How to order see page 4

Dimensions are inches

Shell size	Type F						Type E	
	B_F max	C Thread	D_F min	$G_F \text{ AE}$ min	H_F max	L_F max	B_E max	LE_E max
8	.551	6-32	.236	.114	.760	1.811	.559	1.280
10	.677	6-32	.295	.177	.819	1.811	.677	1.280
12	.803	6-32	.421	.303	.961	1.881	.803	1.280
14	.929	6-32	.547	.366	1.071	1.881	.921	1.280
16	1.051	6-32	.610	.488	1.130	1.929	1.043	1.280
18	1.161	8-32	.772	.614	1.390	1.929	1.165	1.280
20	1.287	8-32	.772	.614	1.390	1.969	1.291	1.358
22	1.413	8-32	.929	.740	1.571	1.969	1.417	1.358
24	1.535	8-32	.992	.791	1.701	1.969	1.543	1.358

*) How to order see page 4

Jam Nut Receptacle KPTC7

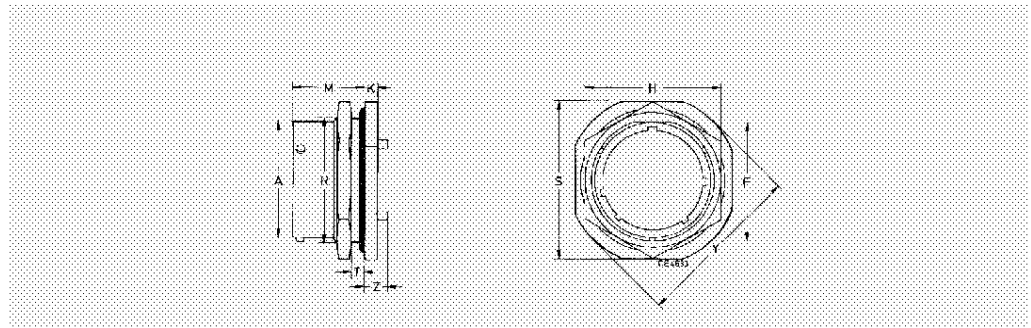
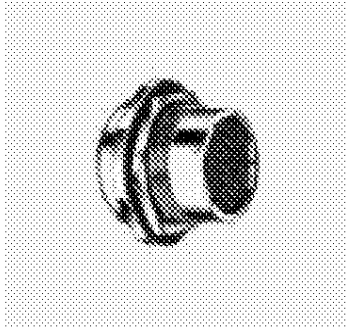

without endbell

Dimensions are mm

Shell size*	A Ø	F	H	K	M	R	S	T Panel thickness		ØY	Z
	+0,03-0,13	±0,15	±0,15	±0,25	±0,15	Thread Class 2 A	±0,5	min.	max.	max.	max.
8	12,0	13,3	19,0	3,2	17,7	9/16-24UNEF	24,0	1,6	3,5	28,0	7,9
10	15,0	16,5	22,2	3,2	17,7	11/16-24UNEF	27,0	1,6	3,5	31,0	7,9
12	19,05	20,6	27,0	3,2	17,7	7/8-20UNEF	32,0	1,6	3,5	36,0	7,9
14	22,23	23,8	30,2	3,2	17,7	1-20UNEF	35,0	1,6	3,5	39,0	7,9
16	25,40	26,9	33,3	3,2	17,7	1-1/8-18UNEF	38,5	1,6	3,5	42,0	7,9
18	28,58	30,1	36,5	3,2	17,7	1-1/4-18UNEF	41,5	1,6	3,5	45,0	7,9
20	31,75	33,3	39,7	4,0	22,5	1-3/8-18UNEF	46,0	1,6	6,5	50,0	4,7
22	34,93	36,5	42,9	4,0	22,5	1-1/2-18UNEF	49,5	1,6	6,5	55,0	4,7
24	38,10	39,6	46,0	4,0	23,3	1-5/8-18UNEF	52,5	1,6	6,5	57,0	3,8

*) How to order see page 4

Dimensions are inches

Shell size*	A	F	H	K	M	R	S	T Panel thickness		Y →	Z
	+ .001-.005	±.006	±.006	±.010	±.006	Thread Class 2	±.010	min	max	max	max
8	.472	.524	.748	.126	.697	9/16-24UNEF	.945	.063	.138	1.102	.311
10	.591	.650	.874	.126	.697	11/16-24UNEF	1.063	.063	.138	1.220	.311
12	.750	.811	1.063	.126	.697	7/8-20UNEF	1.260	.063	.138	1.417	.311
14	.875	.937	1.189	.126	.697	1-20UNEF	1.378	.063	.138	1.535	.311
16	1.000	1.059	1.311	.126	.697	1-1/8-18UNEF	1.516	.063	.138	1.654	.311
18	1.125	1.185	1.437	.126	.697	1-1/4-18UNEF	1.634	.063	.138	1.772	.311
20	1.250	1.311	1.563	.157	.886	1-3/8-18UNEF	1.811	.063	.256	1.969	.185
22	1.375	1.437	1.689	.157	.886	1-1/2-18UNEF	1.949	.063	.256	2.165	.185
24	1.500	1.559	1.811	.157	.917	1-5/8-18UNEF	2.067	.063	.256	2.244	.150

*) How to order see page 4

Jam Nut Receptacle KPTC7

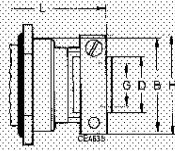

Type F



Typ E

with endbell

Dimensions are mm

Shell size*	Type F					Type E	
	β_F max.	$D_F \varnothing$ min.	$G_F \varnothing$ min.	H_F max.	L_F max.	β_E max.	L_E max.
8	18,2	6,0	2,9	19,3	44,9	18,2	33,5
10	21,5	7,5	4,5	20,8	44,9	21,5	33,5
12	24,6	10,7	7,7	24,2	44,9	24,6	33,5
14	27,8	13,9	9,3	27,2	44,9	27,8	33,5
16	31,0	15,5	12,4	28,7	48,4	31,0	33,5
18	34,1	19,6	15,6	35,3	48,4	34,1	33,5
20	38,1	19,6	15,6	35,3	50,3	38,1	39,0
22	41,2	23,6	18,8	39,8	50,3	41,3	39,0
24	44,5	25,2	20,1	43,2	50,3	44,5	39,0

*) How to order see page 4

Dimensions are inches

Shell size*	Type F					Type E	
	B_F max	$D_F \varnothing$ min	$G_F \varnothing$ min	H_F max	L_F max	B_E max	L_E max
8	.717	.236	.114	.760	1.768	.717	1.319
10	.846	.295	.177	.819	1.768	.846	1.319
12	.969	.421	.303	.953	1.768	.969	1.319
14	1.094	.547	.366	1.071	1.768	1.094	1.319
16	1.220	.610	.488	1.130	1.906	1.220	1.319
18	1.343	.772	.614	1.390	1.906	1.343	1.319
20	1.500	.772	.614	1.390	1.980	1.500	1.535
22	1.622	.929	.740	1.567	1.980	1.622	1.553
24	1.752	.992	.791	1.701	1.980	1.752	1.535

*) How to order see page 4