

● ● ● Price index

**IPA Qualification Certificate:**  
Air Cleanless Class ISO Class 2  
(at v = 1 m/s) upon request

**UL94-V2**  
classifications

**Torsional**  
motion possible

**Special equipment:**  
Electrically conductive ESD/ATEX  
version upon request

- ❶ Large pins for long service life
- ❷ Limited torsion tolerance
- ❸ "E" Series features split crossbar along the outer radius
- ❹ "Z" Series features split crossbar along the inner radius
- ❺ Cable-friendly interior
- ❻ Mounting bracket with integrated strain relief
- ❼ Dirt-repellent exterior
- ❽ Very easy to fill - cables only have to be pushed in
- ❾ The patented push-button principle holds the links together
- ❿ 1- or 2-chamber system available

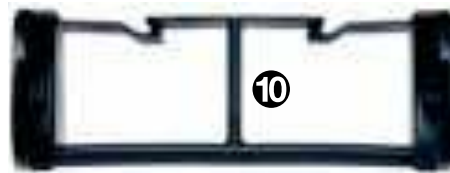

Just push the cables into the e-chain® with your thumb - and it's ready

**When to use the Series E200/Z200:**

- If filling is required without opening and closing lids
- If price is an issue
- If quiet operation is required

**When not to use it:**

- For applications with very high loads and long unsupported travel lengths
  - ▶ Series 2400/2450/2480/2500 E2/000, page 5.160
- If single-extrusion crossbars are required
  - ▶ Series 2400/2450/2480/2500 E2/000, page 5.160



**Order example complete e-chain®**

Please indicate chain-lengths or number of links **Example: 1 m or 22 links**

1 m **E200.05.100.0**

**e-chain®**

1 set **2050.34PZB**

**Mounting bracket**



### Unsupported length

$FL_G$  = with straight upper run

$FL_B$  = with permitted sag

Further information ► Design, page 1.12

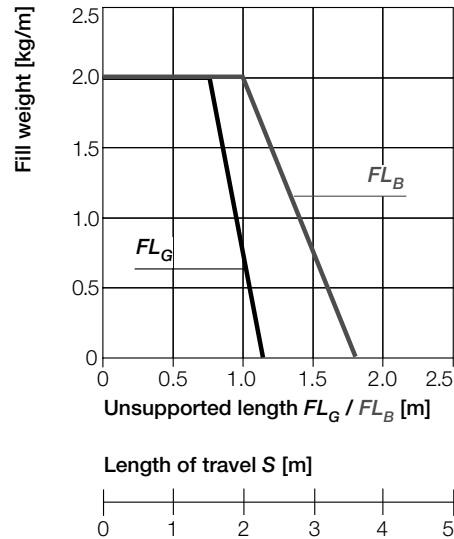
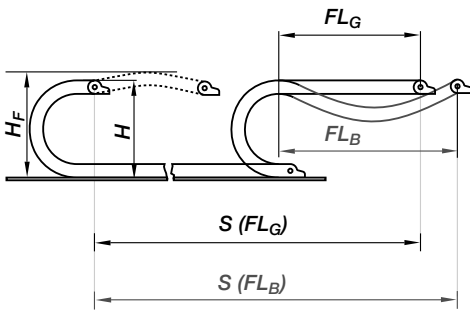

- $S$  = Length of travel
- $R$  = Bending radius
- $H$  = Nominal clearance height
- $H_F$  = Required clearance height
- $D$  = Overlength e-chain® radius in final position
- $K = \pi \cdot R + \text{"safety"}$

#### Other installation methods

- Vertical, hanging  $\leq 10$  m
- Vertical, standing  $\leq 1,5$  m
- Side mounted, unupp.  $\leq 0,5$  m
- Rotary requires further calculation
- Unsupported length of upper run = upon request

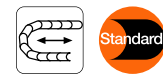
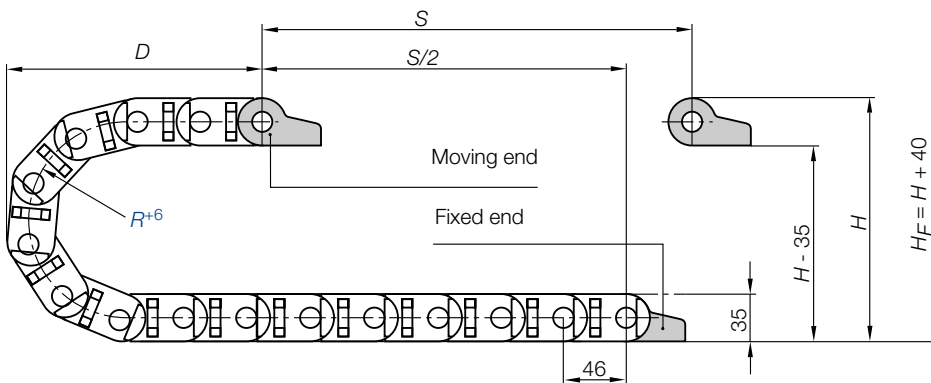

### Short travels - unsupported

Unsupported e-chains® feature positive camber over short travels. This must be accounted for when specifying the clearance height  $H_F$ . Please consult igus® if space is particularly restricted.

Pitch = 46 mm/link    Links/m = 22 (1.012 mm)    Chain length =  $S/2 + K$

R	055	075	100	150	200
$H + 4$	145	185	235	335	435
D	142	162	187	237	287
K	265	330	410	565	725

The required clearance height:  
 $H_F = H + 40$  mm  
(with 2,5 kg/m fill weight)

Speed / acceleration $FL_G$	max. 20 [m/s] / max. 200 [m/s <sup>2</sup> ]
Speed / acceleration $FL_B$	max. 3 [m/s] / max. 6 [m/s <sup>2</sup> ]
Gliding speed / acceleration (maximum)	max. 3 [m/s] / max. 10 [m/s <sup>2</sup> ]
Material (e-chain®)- permitted temperature °C	igumid NB / -40° up to +80° C
Material (mounting brackets)* - permitted temperature °C	igumid G / -40° up to +120° C
Flammability class (e-chain®), igumid NB	VDE 0304 IIC UL94 V2
Flammability class (mounting brackets), igumid G*	VDE 0304 IIC UL94 HB

\*Available in igumid NB upon request, please consult igus® for delivery time

### Technical Data



Details of material properties  
► page 1.38

24,3

easy chain®  
Inner height: 24,3 mm

Phone +49- (0) 22 03-96 49-800  
Fax +49- (0) 22 03-96 49-222

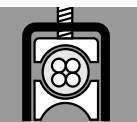

► page 3.5

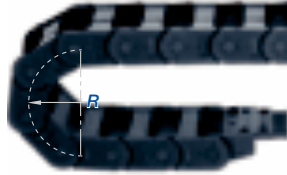
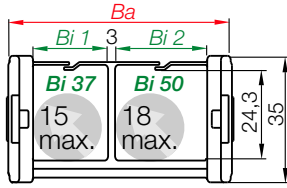
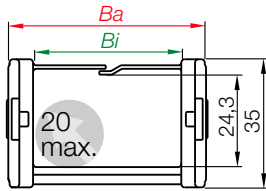

Part No. structure

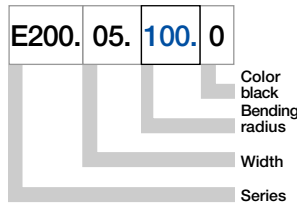

### Series E200 - split crossbar along the outer radius

Part No.	Bi [mm]	Ba [mm]	R [mm]	Bending radii					Weight [kg/m]
E200.05.□.0	57	74,4	055	075	100	150	200	≈ 0,70	

Ba: pin dimension approx. 0,1 - 0,3 mm wider!

Supplement Part No. with required radius. Example: E200.05.100.0

0 = standard color, other colors ▶ page 1.39 · Pitch = 46 mm/link - Links/m = 22

### Series E200 - split crossbar along the outer radius with 2-chamber system

Part No.	Bi [mm]	Ba [mm]	R [mm]	Bending radii					Weight [kg/m]
E200.2/35.□.0	37	94,4	055	075	100	150	200	≈ 0,79	
E200.2/50.□.0	50	120,4	055	075	100	150	200	≈ 0,82	

Ba: pin dimension approx. 0,1 - 0,3 mm wider!

Supplement Part No. with required radius. Example: E200.2/50.100.0

0 = standard color, other colors ▶ page 1.39 · Pitch = 46 mm/link - Links/m = 22

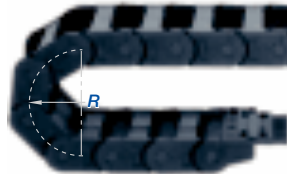
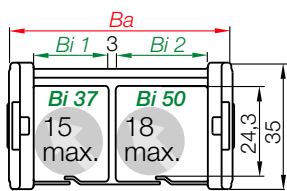
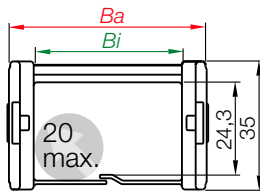

Part No. structure

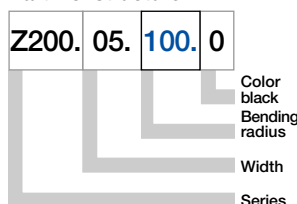

### Series Z200 - split crossbar along the inner radius

Part No.	Bi [mm]	Ba [mm]	R [mm]	Bending radii					Weight [kg/m]
Z200.05.□.0	57	74,4	055	075	100	150	200	≈ 0,70	

Ba: pin dimension approx. 0,1 - 0,3 mm wider!

Supplement Part No. with required radius. Example: Z200.05.100.0

0 = standard color, other colors ▶ page 1.39 · Pitch = 46 mm/link - Links/m = 22

### Series Z200 - split crossbar along the inner radius with 2-chamber system

Part No.	Bi [mm]	Ba [mm]	R [mm]	Bending radii					Weight [kg/m]
Z200.2/35.□.0	37	94,4	055	075	100	150	200	≈ 0,79	
Z200.2/50.□.0	50	120,4	055	075	100	150	200	≈ 0,82	

Ba: pin dimension approx. 0,1 - 0,3 mm wider!

Supplement Part No. with required radius. Example: Z200.2/50.100.0

0 = standard color, other colors ▶ page 1.39 · Pitch = 46 mm/link - Links/m = 22



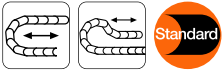

### The Standard - option polymer - pivoting

- Recommended for unsupported and gliding applications
- Well suited for tight installation conditions
- Strain relief with detachable tiewrap plates
- Variable traverse angle for flexible assembly
- The twistability of the e-chain® and the option to assemble the mounting brackets on the fixed end and/or the moving end, enable various installation options

Moving end with bore  
(outer link) 2...3PZ(B)

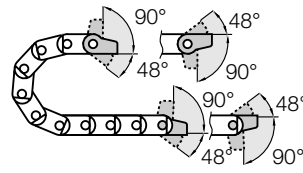

2...4PZ(B) Fixed end  
with pin (inner link)

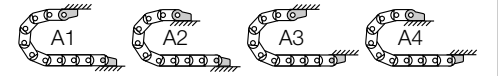

Possible installation conditions for assembled mounting brackets ► Order example "preassembled" below

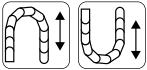

### Option polymer - locking

- Recommended for unsupported and gliding applications
- Furthermore:
- At very high speed and/or acceleration
  - If space is limited for height (the  $H_f$  measurement)
  - The twistability of the e-chain® and the option to assemble the mounting brackets on the fixed end and/or the moving end, enable various installation options

Moving end with bore  
(outer link) 2...1PZ(B)

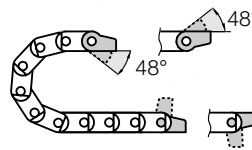

2...2PZ(B) Fixed end  
with pin (inner link)

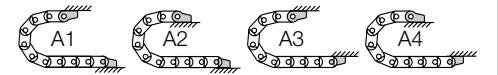

Possible installation conditions for assembled mounting brackets ► Order example "preassembled" below

2...3PZ(B) Standard! (pivoting)

2...1PZ(B) (locking)

Moving end

Standard! (pivoting) 2...4PZ(B)

(locking) 2...2PZ(B)

Fixed end

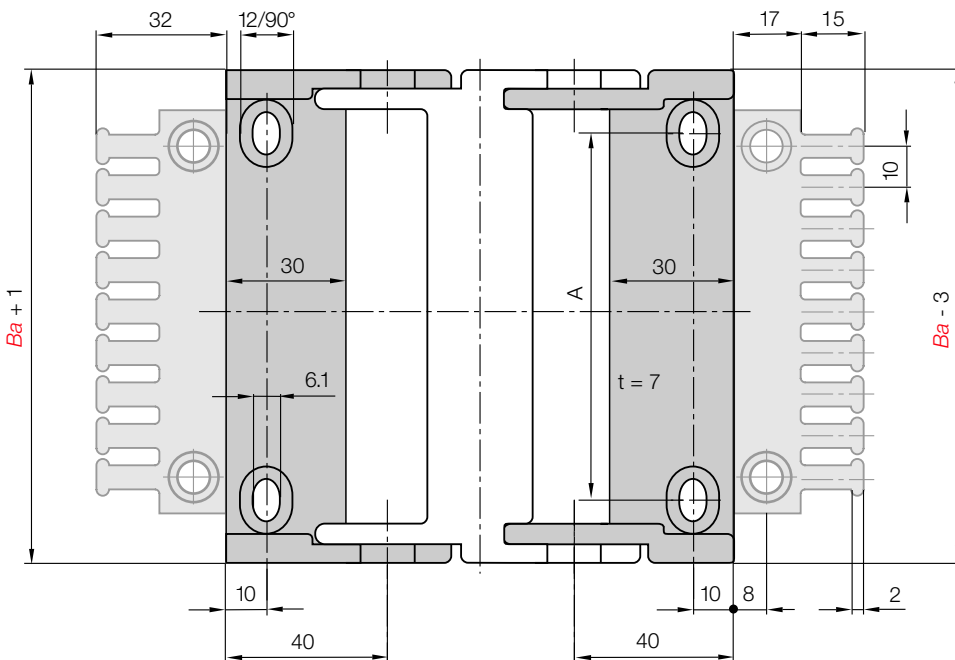

### Dimensions and order configurations

Strain relief is possible on the moving end and/or the fixed end.

#### Part No. structure (pivoting)

2050.	34	PZB	A1	
-------	----	-----	----	--

A... must be indicated on preassembled configurations with assembled tiewrap plates  
Full set pivoting = 34  
Mounting brackets for selected chain type

#### Full set, for both ends:

2050. 34 PZB + tiewrap plate

#### Single-part order:

2050. 3 PZB + tiewrap plate

Mounting bracket with bore

2050. 4 PZB + tiewrap plate

Mounting bracket with pin

#### Part No. structure (locking)

2050.	12	PZB	A1
-------	----	-----	----

A... must be indicated on preassembled configurations with assembled tiewrap plates  
Full set locking = 12  
Mounting brackets for selected chain type

#### Full set, for both ends:

2050. 12 PZB + tiewrap plate

#### Single-part order:

2050. 1 PZB + tiewrap plate

Mounting bracket with bore

2050. 2 PZB + tiewrap plate

Mounting bracket with pin

For e-chain®	Part No. full set with tiewrap plate	Part No. tiewrap plate + 10 cable tiewraps	Part No. full set without tiewrap plate	Number of teeth	Dim. A [mm]
E200-Z200.05	2050. <input type="text"/> PZB	2050. <input type="text"/> PZBK1	2050. <input type="text"/> PZ	6	44
E200-Z200.2/35	2070. <input type="text"/> PZB	2070. <input type="text"/> PZBK1	2070. <input type="text"/> PZ	8	64
E200-Z200.2/50	2100. <input type="text"/> PZB	2100. <input type="text"/> PZBK1	2100. <input type="text"/> PZ	10	90

Please add the Part No. with the requested index - 34 for the pivoting configuration

e.g. 2050. 34 PZB or 12 for the locking configuration e.g. 2050. 12 PZB

For the preassembled mode please add the index A1...A4 e.g. 2050. 34 PZB A1





**Strain relief for polymer mounting brackets (pivoting or locking)**

The strain relief tie-wrap plates can be directly snapped onto the mounting bracket. After bolting the mounting brackets to the machine, the strain relief tie-wrap plates are also firmly connected to the base. They do not need to be bolted on separately. Cable tiewraps secure the tie-wrap plate "teeth" and the cable to provide proper strain relief and save time. **Details ▶ chapter 10**



**Tie-wrap plate as individual part**

As an individual component screwed on or can be plugged into the mounting brackets. **Details ▶ chapter 10**

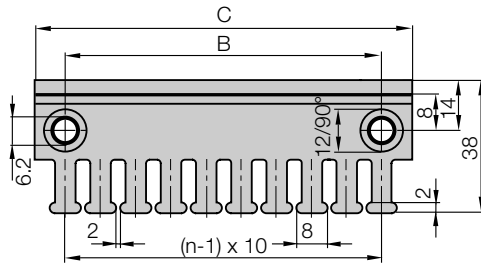
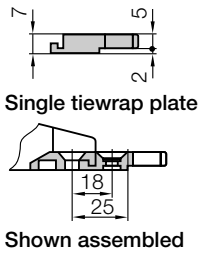

Tie-wrap plate	No. of teeth <i>n</i>	Dim. C [mm]	Dim. B [mm]
2020.ZB	3	30	15
2030.ZB	4	40	20
2040.ZB	5	50	30
2050.ZB	6	60	40
2070.ZB	8	80	60
2090.ZB = (2030.ZB + 2040.ZB)	9	90	-
2100.ZB	10	100	80
2125.ZB = (2050.ZB + 2050.ZB)	12	120	-



**Cable tiewraps as individual part**

Cable tiewraps 100 pieces/bag	Width x length	Max. Ø	Tensile strength
CFB.001	4,8 x 150 mm	36 mm	222 N



**"Double" strain relief**

If an e-chain® is harnessed with a very large number of cables, strain relief may be necessary at two levels. Our 2050.Z strain relief system was developed for this purpose. It can be placed in any position along the e-chain®. As required, the 2050.Z strain relief system is simply clamped onto the crossbar of the chain link. No additional installation elements are needed. **Details ▶ chapter 10**

Part No.	Width strain relief [mm]	No. of teeth
2050.Z	60	6



Other strain relief elements - optional ▶ chapter 10

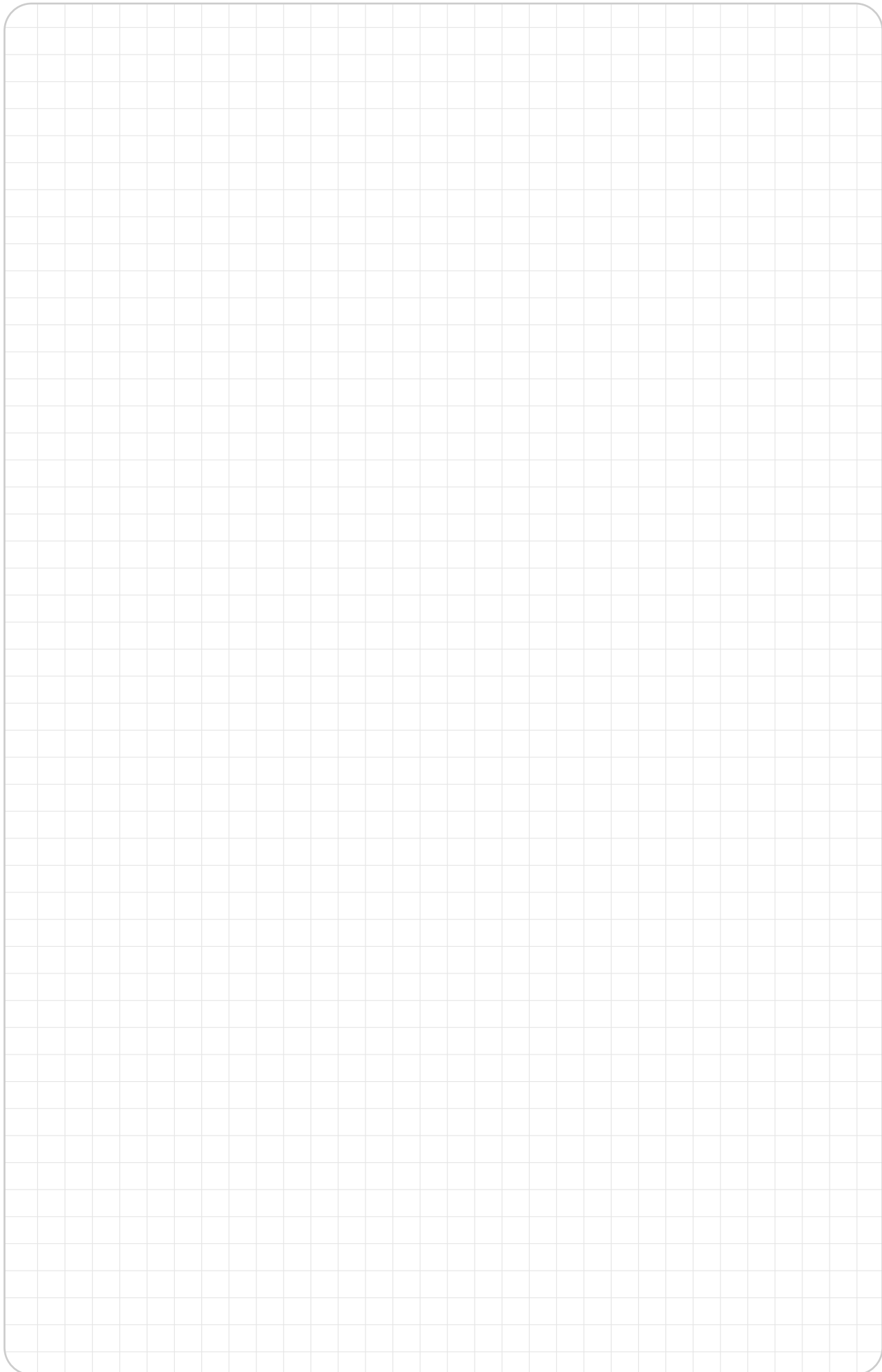

easy chain®

Inner height: 24,3 mm

Phone +49- (0) 22 03-96 49-800

Fax +49- (0) 22 03-96 49-222

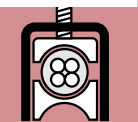
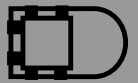

▶ chapter 10



▶ page 3.5