

Part No.	D	d1	d2	H	h1	h2	l1	Material	Color
A1321060	31	6	21.4	20	6.5	17.5	20	Duroplastic	Black

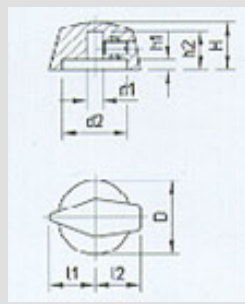

Part No.	D	d1	d2	H	h1	h2	l1	l2	Material	Color
A1311860	18.8	6	16.4	12.5	2.6	10	11.5	11.5	Duroplastic	Black

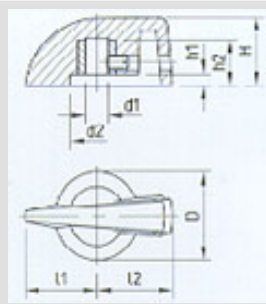

Part No.	D	d1	d2	H	h1	h2	l1	l2	Material	Color
A1319860	20.3	6	14	18	3	14.5	19	20	Duroplastic	Black

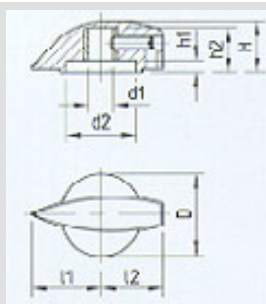

Part No.	D	d1	d2	H	h1	h2	l1	l2	Material	Color
A1317860	20.3	6	16.7	12.8	3	11	17	15	Duroplastic	Black
A1321860	23	6	20.2	16	3.4	14.5	21	19	Duroplastic	Black

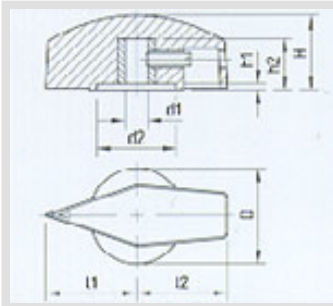
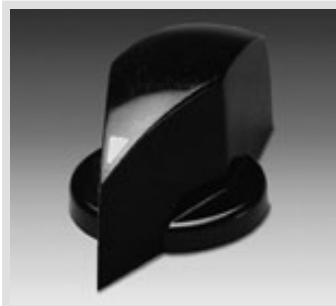

Part No.	D	d1	d2	H	h1	h2	l1	l2	Material	Color
A1324860	25	6	21.1	20	2	14.3	24	24	Duroplastic	Black

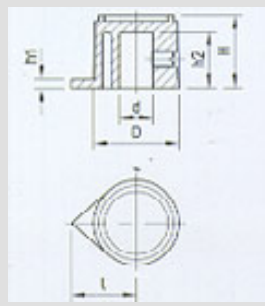

Part No.	D	d	H	h1	h2	l	Material	Color
A1310560	15.4	6	13.2	1.5	9.9	11.6	Duroplastic	Black

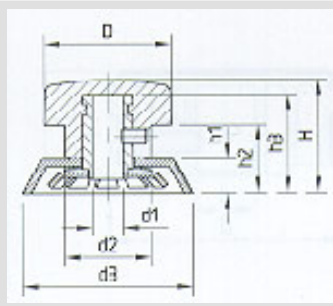

Part No.	D	d1	d2	d3	H	h1	h2	h3	Material	Color
A1331660	25	6	17	31.2	22	7	13	19	Duroplastic	Black
A1342660	31	6	21	41.5	25	8	14.5	22	Duroplastic	Black

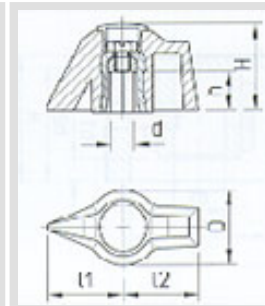

Part No.	D	d	H	h	l1	l2	Material	Color
A1220860	18.5	6	24.4	11.5	20	20	Duroplastic	Black