



Features

- Anti-surge
- Wide resistance range
- RoHS compliant*

Applications

- High voltage applications
- Consumer electronics
- Telecommunications
- Power supplies

CRS Series - High Power Anti-Surge Chip Resistor

Electrical Characteristics

Characteristic	CRS0805	CRS1206	CRS2010	CRS2512
Power Rating @ 70°C	0.25 W	0.5 W	1 W	2 W
Operating Temperature Range	-55 °C to +155 °C			
Maximum Operating Voltage	150 V	200 V	200 V	300 V
Maximum Working Voltage	300 V	400 V	400 V	600 V
Resistance Range / Temperature Coefficient	1 to 9.9 ohms / ±200 PPM/°C 10 ohms to 1 megohm / ±100 PPM/°C			
Tolerance / Standard Resistance Values	1 % / E96 + E24 5 % / E24			

Performance Characteristics

Test	Conditions	Specification
Short Time Overload	2 times rated voltage or maximum overload voltage for 5 seconds.	$\Delta R \leq \pm(2\% + 0.1 \Omega)$
Solderability	245 ±5 °C for 3 ±0.5 seconds.	Over 95 % coverage
Resistance to Solder Heat	260 ±5 °C for 10 ± 1 seconds.	$\Delta R \leq \pm(1\% + 0.1 \Omega)$
Load Life Humidity	40 ±2 °C, 90 to 95 %. 1.5 hours ON, 0.5 hours OFF for 1000 hours at rated power.	$\Delta R \leq \pm(3\% + 0.1 \Omega)$
Load Life	70 °C. 1.5 hours ON, 0.5 hours OFF for 1000 hours at rated power.	$\Delta R \leq \pm(3\% + 0.1 \Omega)$
Temperature Cycle	-55 °C (30 min.), +25 °C (2~3 min.), +155 °C (30 min.), +25 °C (2~3 min.) for five cycles.	$\Delta R \leq \pm(1\% + 0.05 \Omega)$

Recommended Solder Pad Layout

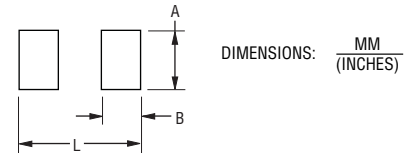

Model	Dimension		
	A	B	L
CRS0805	1.30 (0.051)	1.15 (0.045)	3.50 (0.138)
CRS1206	1.80 (0.071)	1.30 (0.051)	4.70 (0.185)
CRS2010	3.00 (0.118)	1.50 (0.059)	6.80 (0.268)
CRS2512	3.70 (0.146)	2.45 (0.096)	7.60 (0.299)

Construction

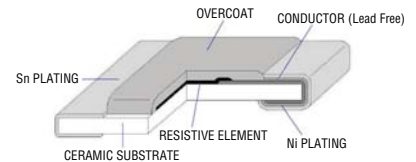

Derating Curve

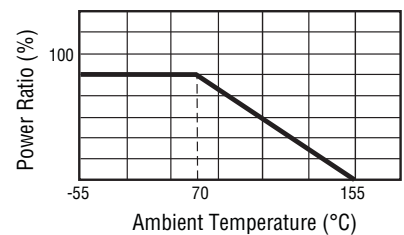

Product Dimensions

Model	Dimension				
	A	B	C	D	T
CRS0805	2.00 ± 0.10 (0.079 ± 0.004)	1.25 ± 0.10 (0.049 ± 0.004)	0.40 ± 0.20 (0.016 ± 0.008)	0.40 ± 0.20 (0.016 ± 0.008)	0.50 ± 0.10 (0.020 ± 0.004)
CRS1206	3.10 ± 0.10 (0.122 ± 0.004)	1.60 ± 0.10 (0.063 ± 0.004)	0.50 ± 0.20 (0.020 ± 0.008)	0.50 ± 0.20 (0.020 ± 0.008)	0.55 ± 0.10 (0.022 ± 0.004)
CRS2010	5.00 ± 0.20 (0.197 ± 0.008)	2.50 ± 0.20 (0.098 ± 0.008)	0.60 ± 0.25 (0.024 ± 0.010)	0.60 ± 0.25 (0.024 ± 0.010)	0.55 ± 0.10 (0.022 ± 0.004)
CRS2512	6.40 ± 0.20 (0.252 ± 0.008)	3.20 ± 0.20 (0.126 ± 0.008)	0.60 ± 0.25 (0.024 ± 0.010)	1.80 ± 0.25 (0.071 ± 0.010)	0.60 ± 0.15 (0.024 ± 0.006)

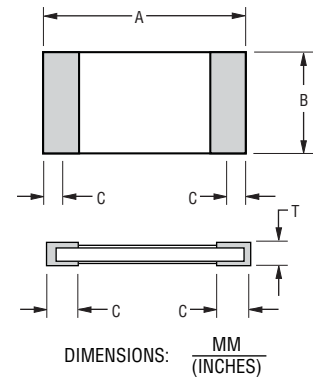

*RoHS Directive 2002/95/EC Jan. 27, 2003 including annex and RoHS Recast 2011/65/EU June 8, 2011.

Specifications are subject to change without notice.

The device characteristics and parameters in this data sheet can and do vary in different applications and actual device performance may vary over time. Users should verify actual device performance in their specific applications.

CRS Series - High Power Anti-Surge Chip Resistor

BOURNS®

Soldering Profile

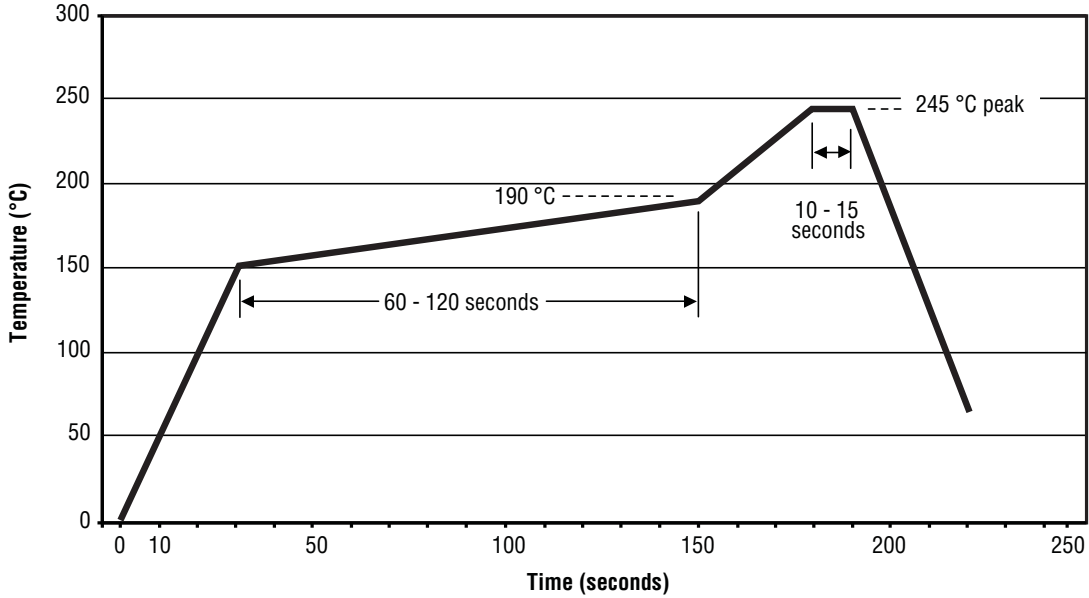

Surge Performance

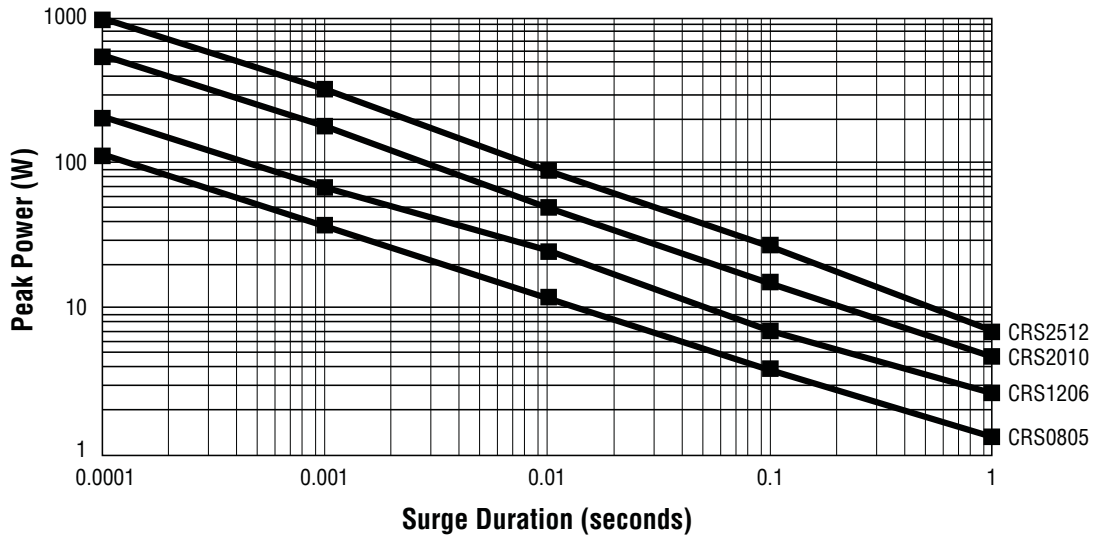

Specifications are subject to change without notice. The device characteristics and parameters in this data sheet can and do vary in different applications and actual device performance may vary over time. Users should verify actual device performance in their specific applications.

CRS Series - High Power Anti-Surge Chip Resistor

BOURNS®

Packaging Dimensions (Conforms to EIA RS-481A)

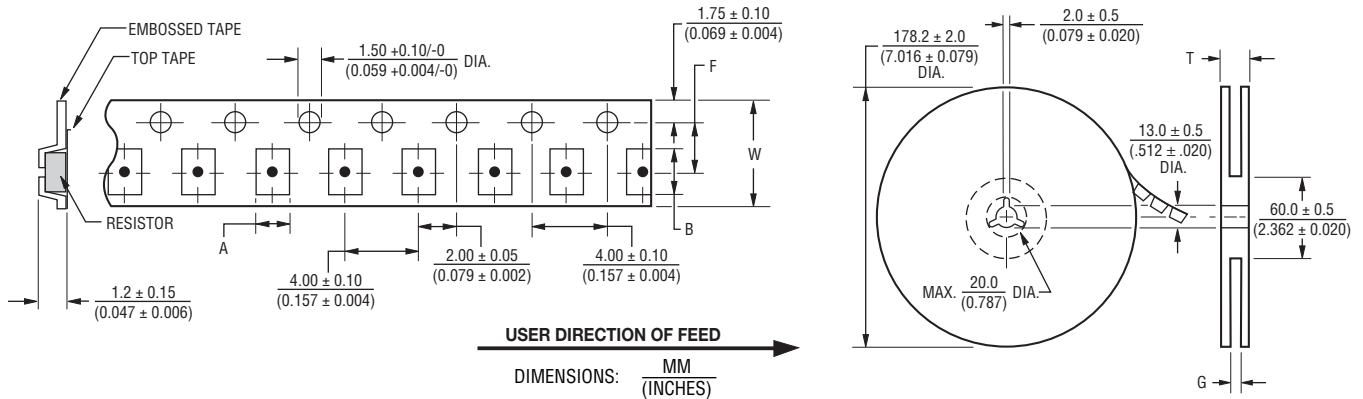

Model	Dimension			
	A	B	F	W
CRS0805	$\frac{1.65 \pm 0.20}{(0.065 \pm 0.008)}$	$\frac{2.40 \pm 0.20}{(0.094 \pm 0.008)}$	$\frac{3.50 \pm 0.05}{(0.138 \pm 0.002)}$	$\frac{8.00 \pm 0.30}{(0.315 \pm 0.012)}$
CRS1206	$\frac{2.00 \pm 0.20}{(0.079 \pm 0.008)}$	$\frac{3.60 \pm 0.10}{(0.142 \pm 0.004)}$	$\frac{3.50 \pm 0.05}{(0.138 \pm 0.002)}$	$\frac{8.00 \pm 0.30}{(0.315 \pm 0.012)}$
CRS2010	$\frac{2.80 \pm 0.20}{(0.110 \pm 0.008)}$	$\frac{5.50 \pm 0.20}{(0.217 \pm 0.008)}$	$\frac{5.50 \pm 0.05}{(0.217 \pm 0.002)}$	$\frac{12.00 \pm 0.30}{(0.472 \pm 0.012)}$
CRS2512	$\frac{3.50 \pm 0.20}{(0.138 \pm 0.008)}$	$\frac{6.70 \pm 0.20}{(0.264 \pm 0.008)}$	$\frac{5.50 \pm 0.05}{(0.217 \pm 0.002)}$	$\frac{12.00 \pm 0.30}{(0.472 \pm 0.012)}$

Model	Pcs. per Reel	Dimension	
		G	T (MAX.)
CRS0805	5,000	$\frac{10.00 \pm 1.50}{0.394 \pm 0.059}$	$\frac{20.00}{(0.587)}$
CRS1206			
CRS2010	4,000	$\frac{13.80 \pm 1.50}{(0.543 \pm 0.059)}$	$\frac{16.70}{(0.657)}$
CRS2512			

How to Order

CRS 2512 - F X - 24R3 E LF

Model _____
 CRS = Anti-Surge Chip Resistor

Size _____
 0805
 1206
 2010
 2512

Resistance Tolerance _____
 F = ±1 %
 J = ±5 %

TCR _____
 X = ±100 PPM/°C
 W = ±200 PPM/°C

Resistance Value _____
 1% Tolerance:
 <100 ohms ,,,,,, "R" represents decimal point (example: 24R3 = 24.3 ohms)
 ≥100 ohms,,,,,, First three digits are significant, fourth digit represents number of zeros to follow (example: 8252 = 82.5K ohms)

5% Tolerance:
 <10 ohms ,,,,,, "R" represents decimal point (example: 4R7 = 4.7 ohms)
 ≥10 ohms,,,,,, First two digits are significant, third digit represents number of zeros to follow (example: 474 = 470K ohms)

Packaging _____
 E = 5,000 pieces per 7-inch reel (CRS0805, CRS1206)
 4,000 pieces per 7-inch reel (CRS2010, CRS2512)

Termination _____
 LF = Tin-plated (RoHS Compliant)

BOURNS®

Asia-Pacific:

Tel: +886-2 2562-4117
 Fax: +886-2 2562-4116

EMEA:

Tel: +36 88 520 390
 Fax: +36 88 520 211

The Americas:

Tel: +1-951 781-5500
 Fax: +1-951 781-5700

www.bourns.com