



SERIES 1881 - SINGLE-POLE ROUND ROCKER SWITCHES

TO 12 (4) A 250 V AC



PRODUCT FEATURES

- Attractive round rocker switch
- High mechanical rating with at least 100 000 switching cycles
- Variants with IP 51
- Low depth with 18.7 mm
- Appliance cut-out with 20 mm

ON REQUEST





















- Other colors
- Other printing variants
- Other terminal variants (e.g. PCB)
- Cable assembly
- Gold-plated contacts for low voltages
- Other switching functions (e.g. 1888 - middle off)
- Painted variants

Mechanical life endurance	10E4
Operating force	3 N
Inrush current (capacitive)	70 A
Contact resistance (new condition)	< 100 mOhm (1 A 12 V DC)
Insulation resistance (new condition)	> 100 MOhm (500 V DC)
Proof tracking	250 PTI
Protection type	IP 40 and IP 51 (product-dependent)
Ambient temperature	terminal side -20 °C ... +100 °C actuating side -20 °C ... +55 °C
Flammability	UL 94 V-2 UL 94 V-0 (product-dependent)
Glow wire test temperature	850 °C
Material actuator housing terminals	PA PA silver plated
Plug force of the terminals	≤ 80 N
Approval marks	
Suitable for appliances of protection class II	



SERIES 1881 - SINGLE-POLE ROUND ROCKER SWITCHES

TO 12 (4) A 250 V AC

 single-pole	Actuator color / printing	Housing color	12 (4) A 250 V AC 1E4	10 (4) A 250 V AC 1E4	8 (8) A 250 V AC 5E4	6 (4) A 250 V AC 5E4	15 A 250 V AC 1 1/2 HP	15 A 125 V AC 3/4 HP	10 A 250 V AC 1/2 HP	10 A 125 V AC 1/3 HP	Terminal type	Terminal description	Contact distance (mm)	Contact material	Actuator	Miscellaneous	Stock version
ON / OFF switch (SPST)																	
1881.1103		Black	○	○		○	○					4.8	≥ 3	Ag	IP 40		○
1881.1104		Black	○	○		○	○					4.8	≥ 3	Ag	IP 40		○
1881.1105		White	○	○		○	○					4.8	≥ 3	Ag	IP 40		○
1881.1106		Black	○	○		○	○					4.8	≥ 3	Ag	IP 40	○	
1881.1108		Black	○	○		○	○					4.8	≥ 3	Ag	IP 51	○	with swtiching system cover
1881.1109		Black	○	○		○	○					4.8	≥ 3	Ag	IP 40		
1881.1111		Black	○	○		○	○					4.8	≥ 3	Ag	IP 40		
1881.1112		White	○	○		○	○					1 mm longer 4.8	≥ 3	Ag	IP 51	○	with swtiching system cover
Normally open contact (SPNO)																	
1881.1209		Black										4.8	≥ 3	Ag	IP 51		with swtiching system cover opening terminal 1b closed
Changeover switch (SPDT)																	
1883.1105		Black		○	○			○	○			4.8	≥ 3	Ag	IP 40		
1883.1106		Black		○	○			○	○			4.8	≥ 3	Ag	IP 40	○	

ROCKERSWITCHES
 PUSHBUTTON SWITCHES
 TOGGLE SWITCHES
 SLIDE SWITCHES
 ROTARY SWITCHES
 FOOT SWITCHES
 TACT AND KEY SWITCHES
 SNAP-ACTION SWITCHES
 MICRO-SIGNAL SWITCHES
 SENSORS
 ECO
 PUSH N'DRIVE



SERIES 1881 - SINGLE-POLE ROUND ROCKER SWITCHES

TO 12 (4) A 250 V AC



Basic type 1881

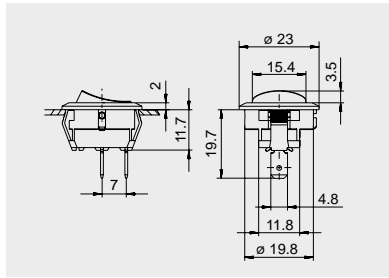

Quick-connect terminal 1 mm longer 4.8 x 0.8

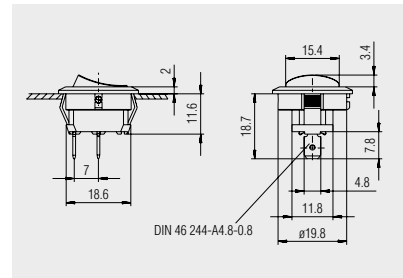

Quick-connect terminal 4.8 x 0.8

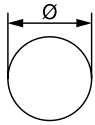

X = Wall thickness

x	Ø
0.75 ... 1.25	20.3
1.25 ... 2	20.8
2 ... 3	21.1



Basic type 1883

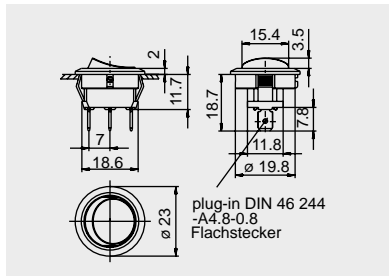

Quick-connect terminal 4.8 x 0.8

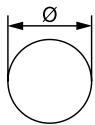

X = Wall thickness

x	Ø
0.75 ... 1.25	21.2 ^{+0.1}
1.25 ... 2	21.4 ^{+0.1}
2 ... 3	21.8 ^{+0.1}

ROCKERSWITCHES

PUSHBUTTON SWITCHES

TOGGLE SWITCHES

SLIDE SWITCHES

ROTARY SWITCHES

FOOT SWITCHES

TACT AND KEY SWITCHES

SNAP-ACTION SWITCHES

MICRO-SIGNAL SWITCHES

SENSORS

ECO

PUSH'N'DRIVE



SERIES 1881 - SINGLE-POLE ROUND ROCKER SWITCHES

TO 12 (4) A 250 V AC



Protection cap
207.122.011

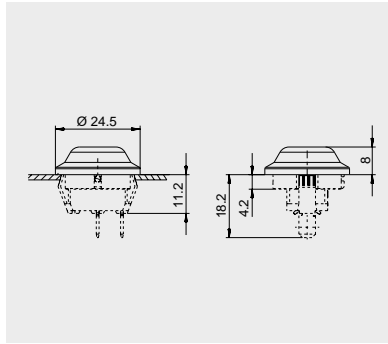

Transparent PVC - protection cap.
Serves as dust and water protection
of the actuation side.

Further information under

WWW.MARQUARDT-SWITCHES.COM

ROCKER SWITCHES

PUSHBUTTON SWITCHES

TOGGLE SWITCHES

SLIDE SWITCHES

ROTARY SWITCHES

FOOT SWITCHES

TACT AND KEY SWITCHES

SNAP-ACTION SWITCHES

MICRO-SIGNAL SWITCHES

SENSORS

ECO

PUSH-IN DRIVE