



SERIES 1855 - MINIATURE DOUBLE-POLE ROCKER SWITCHES

TO 4 (1) A 250 V AC





PRODUCT FEATURES

- Illuminated rocker switches
- Different lamp variants
- Powerful with 50 000 mechanical switching cycles
- Caulked terminals for reliable plugging of the receptacles

ON REQUEST



















- Other colors
- Other printing variants
- Other terminal types
- Other lamp variants
- Cable assembly

Mechanical life endurance	5E4
Contact resistance (new condition)	< 100 mOhm (1 A 12 V DC)
Insulation resistance (new condition)	> 100 MOhm (500 V DC)
Proof tracking	250 PTI
Protection type	IP 40
Ambient temperature	terminal side -20 °C ... +85 °C actuating side -20 °C ... +55 °C
Flammability	UL 94 V-2
Glow wire test temperature	850 °C
Material	actuator PA housing PA terminals silver plated
Plug force of the terminals	≤ 80 N
Approval marks	 /  / 
Suitable for appliances of protection class II	



SERIES 1855 - MINIATURE DOUBLE-POLE ROCKER SWITCHES

TO 4 (1) A 250 V AC

 double-pole	Lighting voltage (V)	Actuator color / printing	Housing color	4 (1) A 250 V AC 1E4			Terminal type	Terminal description	Contact distance (mm)	Contact material	EN 60335 cap. 30 conform "G"	Stock version
					6 A 125 V AC 1/10 HP	4 A 250 V AC 1/10 HP						
ON / OFF switch (DPST)												
1855.0102	230			○		○			≥ 3	Ag		○
1855.0108	230			○		○			≥ 3	Ag		○
1855.1102	230			○		○		4.8	≥ 3	Ag		○
1855.1104	230			○		○		4.8	≥ 3	Ag		○
1855.1108	230			○		○		4.8	≥ 3	Ag		○
1855.1115	230			○		○		4.8	≥ 3	Ag	○	
1855.1118	230			○		○		4.8	≥ 3	Ag	○	
1855.1122	110				○			4.8	≥ 3	Ag		
1855.1124	110				○			4.8	≥ 3	Ag		

ROCKERSWITCHES
 PUSHBUTTON SWITCHES
 TOGGLE SWITCHES
 SLIDE SWITCHES
 ROTARY SWITCHES
 FOOT SWITCHES
 TACT AND KEY SWITCHES
 SNAP-ACTION SWITCHES
 MICRO-SIGNAL SWITCHES
 SENSORS
 ECO
 PUSH N' DRIVE





SERIES 1855 - MINIATURE DOUBLE-POLE ROCKER SWITCHES

TO 4 (1) A 250 V AC

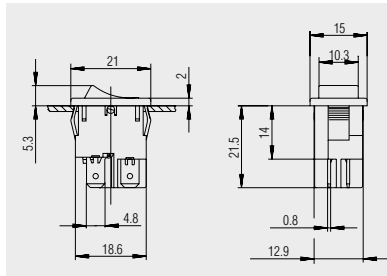

Basic type 1855



 Quick-connect terminal 4.8 x 0.8

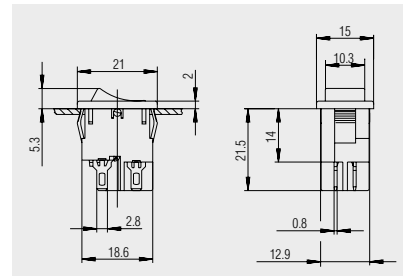

 Solder terminal

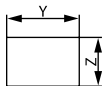

X = Wall thickness

x	y	z
0.75 ... 1.25	19.2 ^{-0.1}	12.9 ^{+0.1}
1.25 ... 2	19.4 ^{-0.1}	12.9 ^{+0.1}
2 ... 3	19.8 ^{-0.1}	12.9 ^{+0.1}



Protection cap
203.089.011

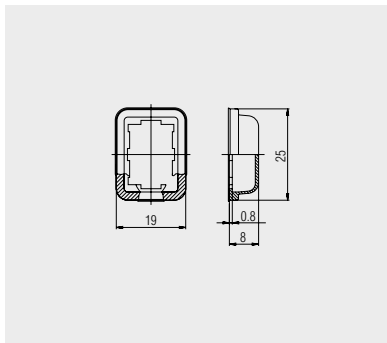

Transparent PVC-protection cap.
Serves as dust and water protection
for the actuating side.

ROCKERSWITCHES

PUSHBUTTON SWITCHES

TOGGLE SWITCHES

SLIDE SWITCHES

ROTARY SWITCHES

FOOT SWITCHES

TACT AND KEY SWITCHES

SNAP-ACTION SWITCHES

MICRO-SIGNAL SWITCHES

SENSORS

ECO

PUSH'N'DRIVE

1	2	3	4	
A	Empfohlener Ausschnitt für Rastbefestigung (Grat gegenüber Bestückungsseite) recommended cut-out for snap-in fixing (edge opposite to snap-in direction)	Wanddicke wall thickness	Ausschnittlänge length of cut-out	Ausschnittbreite width of cut-out
		0.75 to / bis 1.25	19.2 -0.1	12.9 +0.1
		1.25 to / bis 2	19.4 -0.1	12.9 +0.1
		2 to / bis 3	19.8 -0.1	12.9 +0.1

VERTRAULICH-CONFIDENTIAL

© Alle Rechte bei Marquardt, auch fuer den Fall von Schutzrechtsanmeldungen. Jede Veruegungsbefugnis, wie Kopier- und Weitergaberecht, bei uns.

© This document is the exclusive property of Marquardt. Without our consent, it may not be reproduced or given to third parties.

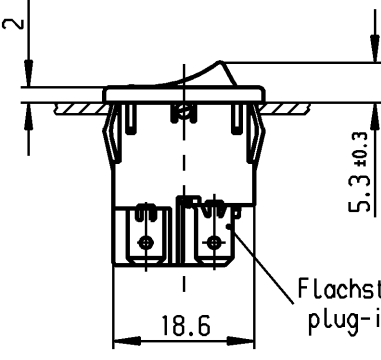
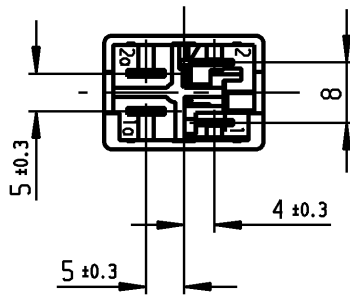

DIN 46 244-A4.8-0.8

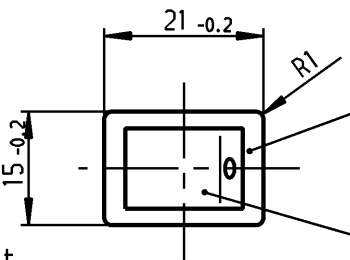
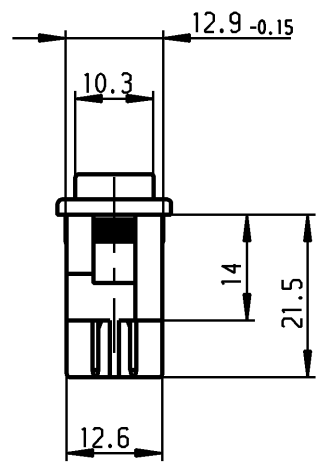

schwarz
black

Wippe grün transp.
Zeichen weiß
rocker green transp.
symbol white

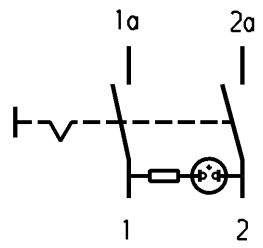

Aufschrift
Marking

1855.
6A 125V AC
1/10 HP
R53



1a 1
Herstellort/-jahr/-monat nach
code of manufacture
place/year/month acc. to:
DIN EN 60062

Ausschalter 2-polig
Glimmlampe mit R_v für 115 V ~
Für Geräte der Klasse II geeignet

DPST
neon lamp with R_v for 115V AC
suitable for appliances of class II

Schutzvermerk
nach DIN 34 beachten
COPYRIGHT RESERVED

Allgemeintoleranzen/UNTOLERANCED DIMENSIONS				PROJECTION		Pause COPY		Blatt SHEET		Zeichn./DRAWING NO.	
Für Längen und Radien FOR LENGTHS AND RADII.		Abmaße in mm für Nennmaßbereich in mm ALL DIMENSIONS ARE IN MILLIMETRES					Original DIN A4 Maßstab SCALE 1:1		K 1855.1122		
		bis/UP TO 6	über/OVER 6 bis/UP TO 30	über/OVER 30							
±	0.2	0.4				0 10 20 30 mm		Geraeteschalter Appliance Switch			
d	63303	28.05.09 hhe	i		gez./DRAWN BY 29.06.93 Mut gepr./CHECKED BY Lr						
c	23451	05.07.95 R5	h								
b	22297	29.06.93 Mut	g								
a	16760	08.07.85 Hs	f		Ersatz für/REPLACEMENT OF Zeichng. gl. Nr. vom 19.10.79						
			e	66876 21.01.10 hhe							
Ausg. ISSUE	Anderung REVISION	gez. DRAWN BY	Ausg. ISSUE	Anderung REVISION	gez. DRAWN BY	 Marquardt, D-78604 Riethem-Weilheim					