



SERIES 1800 - SINGLE AND DOUBLE-POLE ROCKER SWITCHES

T0 12 (4) A 250 V AC



PRODUCT FEATURES

- 100 million times proven switching principle
- High, flexible design variety
- Excellent actuating characteristic
- Illuminated and non-illuminated variants

ON REQUEST

- Other colors
- Other printing variants
- Other lamp variants
- Snap-on, customized actuators
- Cable assembly

Mechanical life endurance	10E4 5E4 (basic types 1808 and 1809)
Inrush current (capacitive)	50 A 70 A (contact pairing Ag / Ag, product-dependent)
Contact resistance (new condition)	< 100 mOhm (1 A 12 V DC)
Insulation resistance (new condition)	> 100 MOhm (500 V DC)
Proof tracking	250 PTI
Protection type	IP 40
Ambient temperature	terminal side -20 °C ... +100 °C ... +85 °C (product-dependent) actuating side -20 °C ... +55 °C
Flammability	UL 94 V-2 UL 94 V-0 (product-dependent)
Glow wire test temperature	850 °C
Material actuator housing terminals	PA / PC PA silver plated / tinned / gold plated
Plug force of the terminals	≤ 80 N
Approval marks	
Suitable for appliances of protection class II	



SERIES 1800 - SINGLE AND DOUBLE-POLE ROCKER SWITCHES

TO 12 (4) A 250 V AC

single-pole		ON / OFF switch (SPST)														
		1800.0102	1800.0108	1800.1102	1800.1104	1800.1108	1801.1121	1801.1148	1801.1520	1801.1908	1801.1926	1801.6122	1801.6130	1801.1101	1801.1102	1801.1119
Lighting voltage (V)		230	230	230	230	230										
Actuator color / printing																
Housing color																
12 (4) A 250 V AC 1E4							○	○	○	○	○	○	○			
10 (4) A 250 V AC 1E4		○	○	○	○	○								○	○	○
8 (8) A 250 V AC 5E4							○	○	○	○	○	○	○			
6 (4) A 250 V AC 5E4		○	○	○	○	○								○	○	○
6 (2) A 250 V AC 1E4																
4 (3) A 250 V AC 6E3																
4 (2) A 250 V AC 1E4																
30 mA 12 V DC 5E4																
15 A 250 V AC 1 1/2 HP							○	○	○	○	○	○	○			
15 A 125 V AC 3/4 HP							○	○	○	○	○	○	○			
10 A 250 V AC 1/2 HP																
10 A 125 V AC 1/3 HP																
6 A 250 V AC 1/2 HP		○	○	○	○	○								○	○	○
6 A 125 V AC 1/4 HP														○	○	○
6 A 125 - 250 V AC 1/8 HP																
6 A 125 V AC 1/10 HP																
4 A 250 V AC 1/10 HP																
Terminal type																
Terminal description				4.8	4.8	4.8	4.8	4.8	4.8	4.8	4.8	4.8		4.8	4.8	4.8
Inrush current (capacitive) (A)							70	70	70	70	70	70	70		50	50
Contact distance (mm)		≥ 3	≥ 3	≥ 3	≥ 3	≥ 3	≥ 3	≥ 3	≥ 3	≥ 3	≥ 3	≥ 3	≥ 3	≥ 3	≥ 3	≥ 3
Contact material		Ag	Ag	Ag	Ag	Ag	Ag	Ag	Ag	Ag	Ag	Ag	Ag	Ag	Ag	Ag
EN 60335 cap. 30 conform "G"											○	○				
Miscellaneous		sealing plate	sealing plate						snap-on rocker							
Stock version				○		○	○			○		○		○	○	○



SERIES 1800 - SINGLE AND DOUBLE-POLE ROCKER SWITCHES

TO 12 (4) A 250 V AC

<div style="text-align: center;">  <p>single-pole</p> </div>	ON / OFF switch (SPST)								Normally closed contact (SPNC)		Normally open contact (SPNO)		
	1801.1146	1801.1403	1801.2106	1801.2402	1801.2702	1801.5102	1801.6101	1801.6102	1801.6115	1801.1151	1801.1302	1801.1303	1801.6222
Lighting voltage (V)													
Actuator color / printing													
Housing color	black	black	black	black	black	black	white	black	black	black	black	black	black
12 (4) A 250 V AC 1E4													
10 (4) A 250 V AC 1E4	o	o	o	o	o	o	o	o	o				o
8 (8) A 250 V AC 5E4													
6 (4) A 250 V AC 5E4	o	o	o	o	o	o	o	o	o				o
6 (2) A 250 V AC 1E4													
4 (3) A 250 V AC 6E3													
4 (2) A 250 V AC 1E4											o	o	
30 mA 12 V DC 5E4										o			
15 A 250 V AC 1 1/2 HP													
15 A 125 V AC 3/4 HP													
10 A 250 V AC 1/2 HP													
10 A 125 V AC 1/3 HP													
6 A 250 V AC 1/2 HP	o	o	o	o	o	o	o	o	o				o
6 A 125 V AC 1/4 HP	o	o	o	o	o	o	o	o	o				o
6 A 125 - 250 V AC 1/8 HP													
6 A 125 V AC 1/10 HP											o	o	
4 A 250 V AC 1/10 HP											o	o	
Terminal type													
Terminal description	4.8	4.8							4.8		4.8		4.8
Inrush current (capacitive) (A)	50	50	50	50	50	50	50	50	50				
Contact distance (mm)	≥ 3	≥ 3	≥ 3	≥ 3	≥ 3	≥ 3	≥ 3	≥ 3	≥ 3	≥ 3	≥ 3	≥ 3	≥ 3
Contact material	Ag	Ag	Ag	Ag	Ag	Ag	Ag	Ag	Ag	Au	Ag	Ag	Ag
EN 60335 cap. 30 conform "G"										o			
Miscellaneous		with dust cap black		installation depth 13.2	installation depth 28.1								
Stock version	o	o	o				o	o	o				o

ROCKERSWITCHES
 PUSHBUTTON SWITCHES
 TOGGLE SWITCHES
 SLIDE SWITCHES
 ROTARY SWITCHES
 FOOT SWITCHES
 TACT AND KEY SWITCHES
 SMP-ACTION SWITCHES
 MICRO-SIGNAL SWITCHES
 SENSORS
 ECO
 PUSH N' DRIVE



SERIES 1800 - SINGLE AND DOUBLE-POLE ROCKER SWITCHES

TO 12 (4) A 250 V AC

<div style="text-align: center;">  <p>single-pole</p> </div>	Normally open contact (SPNO)		Changeover switch (SPDT)							Changeover switch with OFF position in the center (SPDT - Center OFF)				
	1801.1202	1801.2202	1803.1102	1803.1121	1803.2102	1803.5102	1803.6102	1803.6152	1808.1101	1808.1102	1808.1103	1808.1112	1808.1202	
Lighting voltage (V)														
Actuator color / printing														
Housing color														
12 (4) A 250 V AC 1E4														
10 (4) A 250 V AC 1E4			<input type="checkbox"/>	<input type="checkbox"/>	<input type="checkbox"/>	<input type="checkbox"/>	<input type="checkbox"/>							
8 (8) A 250 V AC 5E4														
6 (4) A 250 V AC 5E4			<input type="checkbox"/>	<input type="checkbox"/>	<input type="checkbox"/>	<input type="checkbox"/>	<input type="checkbox"/>							
6 (2) A 250 V AC 1E4									<input type="checkbox"/>	<input type="checkbox"/>	<input type="checkbox"/>	<input type="checkbox"/>	<input type="checkbox"/>	
4 (3) A 250 V AC 6E3														
4 (2) A 250 V AC 1E4	<input type="checkbox"/>	<input type="checkbox"/>												
30 mA 12 V DC 5E4								<input type="checkbox"/>						
15 A 250 V AC 1 1/2 HP														
15 A 125 V AC 3/4 HP														
10 A 250 V AC 1/2 HP				<input type="checkbox"/>										
10 A 125 V AC 1/3 HP				<input type="checkbox"/>										
6 A 250 V AC 1/2 HP			<input type="checkbox"/>		<input type="checkbox"/>	<input type="checkbox"/>	<input type="checkbox"/>							
6 A 125 V AC 1/4 HP			<input type="checkbox"/>		<input type="checkbox"/>	<input type="checkbox"/>	<input type="checkbox"/>							
6 A 125 - 250 V AC 1/8 HP									<input type="checkbox"/>	<input type="checkbox"/>	<input type="checkbox"/>	<input type="checkbox"/>	<input type="checkbox"/>	
6 A 125 V AC 1/10 HP	<input type="checkbox"/>	<input type="checkbox"/>												
4 A 250 V AC 1/10 HP	<input type="checkbox"/>	<input type="checkbox"/>												
Terminal type														
Terminal description	4.8		4.8	4.8					4.8	4.8	4.8	4.8	4.8	4.8
Inrush current (capacitive) (A)														
Contact distance (mm)	≥ 3	≥ 3	≥ 3	≥ 3	≥ 3	≥ 3	≥ 3	≥ 3	< 3	< 3	< 3	< 3	< 3	< 3
Contact material	Ag	Ag	Ag	Ag	Ag	Ag	Ag	Au	Ag	Ag	Ag	Ag	Ag	Ag
EN 60335 cap. 30 conform "G"												<input type="checkbox"/>		
Miscellaneous													momentary function one side	
Stock version	<input type="checkbox"/>		<input type="checkbox"/>		<input type="checkbox"/>		<input type="checkbox"/>			<input type="checkbox"/>	<input type="checkbox"/>		<input type="checkbox"/>	<input type="checkbox"/>

ROCKERSWITCHES

PUSHBUTTON SWITCHES

TOGGLE SWITCHES

SLIDE SWITCHES

ROTARY SWITCHES

FOOT SWITCHES

TACT AND KEY SWITCHES

SNAP-ACTION SWITCHES

MIKRO-SIGNALSCHALTER

SENSORS

ECO

PUSH'N'DRIVE



SERIES 1800 - SINGLE AND DOUBLE-POLE ROCKER SWITCHES

TO 12 (4) A 250 V AC

single-pole		Changeover switch with OFF position in the center (SPDT - Center OFF)										Changeover switch (SPDT momentary)		
		1808.1302	1808.2102	1808.2302	1808.2704	1808.6102	1808.6103	1808.6202	1808.6302	1808.1152	1808.1353	1803.6222	1803.1202	1803.1252
Lighting voltage (V)														
Actuator color / printing														
Housing color														
12 (4) A 250 V AC 1E4														
10 (4) A 250 V AC 1E4											○			
8 (8) A 250 V AC 5E4														
6 (4) A 250 V AC 5E4											○			
6 (2) A 250 V AC 1E4		○	○	○	○	○	○	○	○					
4 (3) A 250 V AC 6E3														
4 (2) A 250 V AC 1E4												○		
30 mA 12 V DC 5E4										○	○			○
15 A 250 V AC 1 1/2 HP														
15 A 125 V AC 3/4 HP														
10 A 250 V AC 1/2 HP											○			
10 A 125 V AC 1/3 HP											○			
6 A 250 V AC 1/2 HP														
6 A 125 V AC 1/4 HP														
6 A 125 - 250 V AC 1/8 HP		○	○	○	○	○	○	○	○					
6 A 125 V AC 1/10 HP												○		
4 A 250 V AC 1/10 HP												○		
Terminal type														
Terminal description		4.8								4.8		4.8	4.8	
Inrush current (capacitive) (A)														
Contact distance (mm)		< 3	< 3	< 3	< 3	< 3	< 3	< 3	< 3	< 3	>= 3	>= 3	>= 3	
Contact material		Ag	Ag	Ag	Ag	Ag	Ag	Ag	Ag	Au	Ag	Ag	Au	
EN 60335 cap. 30 conform "G"														
Miscellaneous		momentary function both sides	PCB tinned	PCB tinned momentary function both sides	installation depth 29.6			momentary function one side	momentary function both sides					
Stock version		○	○	○		○	○		○		○	○		

ROCKER SWITCHES
 PUSHBUTTON SWITCHES
 TOGGLE SWITCHES
 SLIDE SWITCHES
 ROTARY SWITCHES
 FOOT SWITCHES
 TACT AND KEY SWITCHES
 SMP-ACTION SWITCHES
 MICRO-SIGNAL SWITCHES
 SENSORS
 ECO
 PUSH N' DRIVE



SERIES 1800 - SINGLE AND DOUBLE-POLE ROCKER SWITCHES

TO 12 (4) A 250 V AC

 double-pole		ON / OFF switch (DPST)														
Lighting voltage (V)		1805.6102	1805.6108	1805.7104	1805.7109	1805.7110	1805.7112	1805.7118	1802.1121	1802.1123	1802.2504	1802.3311	1802.6123	1802.1101	1802.1102	1802.1108
Actuator color / printing																
Housing color																
12 (4) A 250 V AC 1E4							○	○	○	○	○	○	○			
10 (4) A 250 V AC 1E4		○	○	○	○	○								○	○	○
8 (8) A 250 V AC 5E4							○	○	○	○	○	○	○			
6 (4) A 250 V AC 5E4		○	○	○	○	○								○	○	○
6 (2) A 250 V AC 1E4																
4 (3) A 250 V AC 6E3																
4 (2) A 250 V AC 1E4																
30 mA 12 V DC 5E4																
15 A 250 V AC 1 1/2 HP							○	○	○	○	○	○	○			
15 A 125 V AC 3/4 HP							○	○	○	○	○	○	○			
10 A 250 V AC 1/2 HP																
10 A 125 V AC 1/3 HP																
6 A 250 V AC 1/2 HP		○	○	○	○	○								○	○	○
6 A 125 V AC 1/4 HP														○	○	○
6 A 125 - 250 V AC 1/8 HP																
6 A 125 V AC 1/10 HP																
4 A 250 V AC 1/10 HP																
Terminal type																
Terminal description				4.8	4.8	4.8	4.8	4.8	4.8	4.8	4.3 lang	4.8 75° angled M3		4.8	4.8	4.8
Inrush current (capacitive) (A)		50	50	50	50	50	70	70	70	70	70	70	70	50	50	50
Contact distance (mm)		≥ 3	≥ 3	≥ 3	≥ 3	≥ 3	≥ 3	≥ 3	≥ 3	≥ 3	≥ 3	≥ 3	≥ 3	≥ 3	≥ 3	≥ 3
Contact material		Ag	Ag	Ag	Ag	Ag	Ag	Ag	Ag	Ag	Ag	Ag	Ag	Ag	Ag	Ag
EN 60335 cap. 30 conform "G"							○									
Miscellaneous		installation depth 17.5	installation depth 17.5	installation depth 19.5	installation depth 19.5	installation depth 19.5	installation depth 20.5 ignition voltage < 100 V	installation depth 20.5 ignition voltage < 100 V			installation depth 16.2	shortened gate				
Stock version				○	○	○		○	○	○			○	○	○	○



SERIES 1800 - SINGLE AND DOUBLE-POLE ROCKER SWITCHES

TO 12 (4) A 250 V AC

 double-pole		ON / OFF switch (DPST)					Normally open contact (DPNO)	Changeover switch (DPDT)				Changeover switch with OFF position in the center (DPDT - Center OFF)	
Lighting voltage (V)	Actuator color / printing	1802.2102	1802.2104	1802.3102	1802.5103	1802.6152	1802.1221	1804.1102	1804.1125	1804.2102	1804.6121	1809.1102	1809.1202
Housing color		[Red/Black]					[Black]	[Black]				[Black]	
12 (4) A 250 V AC 1E4													
10 (4) A 250 V AC 1E4		○	○	○	○			○	○	○	○		
8 (8) A 250 V AC 5E4													
6 (4) A 250 V AC 5E4		○	○	○	○			○	○	○	○		
6 (2) A 250 V AC 1E4												○	
4 (3) A 250 V AC 6E3													○
4 (2) A 250 V AC 1E4							○						
30 mA 12 V DC 5E4						○							
15 A 250 V AC 1 1/2 HP													
15 A 125 V AC 3/4 HP													
10 A 250 V AC 1/2 HP									○				
10 A 125 V AC 1/3 HP									○				
6 A 250 V AC 1/2 HP		○	○	○	○			○		○			
6 A 125 V AC 1/4 HP		○	○	○	○			○		○			
6 A 125 - 250 V AC 1/8 HP												○	
6 A 125 V AC 1/10 HP												○	
4 A 250 V AC 1/10 HP												○	
Terminal type		U	U	U	J	U	U	U	U	U	U	U	U
Terminal description				4.8 M3			4.8	4.8	1 mm longer 4.8			4.8	4.8
Inrush current (capacitive) (A)		50	50	50	50								
Contact distance (mm)		≥ 3	≥ 3	≥ 3	≥ 3	≥ 3	≥ 3	≥ 3	≥ 3	≥ 3	≥ 3	< 3	< 3
Contact material		Ag	Ag	Ag	Ag	Au	Ag	Ag	Ag	Ag	Ag	Ag	Ag
EN 60335 cap. 30 conform "G"													
Miscellaneous													momentary function one side
Stock version		○	○	○	○		○	○	○	○	○	○	○

ROCKER SWITCHES
 PUSHBUTTON SWITCHES
 TOGGLE SWITCHES
 SLIDE SWITCHES
 ROTARY SWITCHES
 FOOT SWITCHES
 TACT AND KEY SWITCHES
 MICRO-SIGNAL SWITCHES
 SMP-ACTION SWITCHES
 SENSORS
 ECO
 PUSH N' DRIVE



SERIES 1800 - SINGLE AND DOUBLE-POLE ROCKER SWITCHES

TO 12 (4) A 250 V AC

ROCKERSWITCHES

PUSHBUTTON SWITCHES

TOGGLE SWITCHES

SLIDE SWITCHES

ROTARY SWITCHES

FOOT SWITCHES

TACT AND KEY SWITCHES

SNAP-ACTION SWITCHES

MIKRO-SIGNALSCHALTER

SENSORS

ECO











PUSH'N'DRIVE

<p>double-pole</p>		1809.1302		1809.2102		1804.1225	
		Changeover switch with OFF position in the center (DPDT - Center OFF)		Changeover switch (DPDT momentary)			
Lighting voltage (V)							
Actuator color / printing							
Housing color							
12 (4) A 250 V AC 1E4							
10 (4) A 250 V AC 1E4							
8 (8) A 250 V AC 5E4							
6 (4) A 250 V AC 5E4							
6 (2) A 250 V AC 1E4		○	○				
4 (3) A 250 V AC 6E3						○	
4 (2) A 250 V AC 1E4							
30 mA 12 V DC 5E4							
15 A 250 V AC 1 1/2 HP							
15 A 125 V AC 3/4 HP							
10 A 250 V AC 1/2 HP							
10 A 125 V AC 1/3 HP							
6 A 250 V AC 1/2 HP							
6 A 125 V AC 1/4 HP							
6 A 125 - 250 V AC 1/8 HP		○	○				
6 A 125 V AC 1/10 HP						○	
4 A 250 V AC 1/10 HP						○	
Terminal type							
Terminal description		4.8				1 mm longer 4.8	
Inrush current (capacitive) (A)							
Contact distance (mm)		< 3	< 3			≥ 3	
Contact material		Ag	Ag			Ag	
EN 60335 cap. 30 conform "G"							
Miscellaneous		momentary function both sides	PCB tinned				
Stock version		○					



SERIES 1800 - SINGLE AND DOUBLE-POLE ROCKER SWITCHES

TO 12 (4) A 250 V AC

















Combination 	ON / OFF switch (SPST)		Changeover switch with OFF position in the center (SPDT - Center OFF)
	1806.1102	1806.6108	
Lighting voltage (V)			
Actuator color / printing			
Housing color			
12 (4) A 250 V AC 1E4			
10 (4) A 250 V AC 1E4	○	○	
8 (8) A 250 V AC 5E4			
6 (4) A 250 V AC 5E4	○	○	
6 (2) A 250 V AC 1E4			○
4 (3) A 250 V AC 6E3			
4 (2) A 250 V AC 1E4			
30 mA 12 V DC 5E4			
15 A 250 V AC 1 1/2 HP			
15 A 125 V AC 3/4 HP			
10 A 250 V AC 1/2 HP			
10 A 125 V AC 1/3 HP			
6 A 250 V AC 1/2 HP	○	○	
6 A 125 V AC 1/4 HP	○	○	
6 A 125 - 250 V AC 1/8 HP			
6 A 125 V AC 1/10 HP			
4 A 250 V AC 1/10 HP			
Terminal type			
Terminal description	4.8		4.8
Inrush current (capacitive) (A)			
Contact distance (mm)	≥ 3	≥ 3	< 3
Contact material	Ag	Ag	Ag
EN 60335 cap. 30 conform "G"			
Miscellaneous		without separating gate	life endurance 50.000 cycles
Stock version	○		

ROCKER SWITCHES
PUSHBUTTON SWITCHES
TOGGLE SWITCHES
SLIDE SWITCHES
ROTARY SWITCHES
FOOT SWITCHES
TACT AND KEY SWITCHES
SNAP-ACTION SWITCHES
MICRO-SIGNAL SWITCHES
SENSORS
ECO
PUSH N' DRIVE



SERIES 1800 - SINGLE AND DOUBLE-POLE ROCKER SWITCHES

TO 12 (4) A 250 V AC

Lamp	Lamp				
	1806.1508	1807.1102	1807.1108	1807.1126	1807.6103
					
Lighting voltage (V)	230 230	230	230	230	230
Actuator color / printing					
Housing color					
12 (4) A 250 V AC 1E4					
10 (4) A 250 V AC 1E4					
8 (8) A 250 V AC 5E4					
6 (4) A 250 V AC 5E4					
6 (2) A 250 V AC 1E4					
4 (3) A 250 V AC 6E3					
4 (2) A 250 V AC 1E4					
30 mA 12 V DC 5E4					
15 A 250 V AC 1 1/2 HP					
15 A 125 V AC 3/4 HP					
10 A 250 V AC 1/2 HP					
10 A 125 V AC 1/3 HP					
6 A 250 V AC 1/2 HP					
6 A 125 V AC 1/4 HP					
6 A 125 - 250 V AC 1/8 HP					
6 A 125 V AC 1/10 HP					
4 A 250 V AC 1/10 HP					
Terminal type					
Terminal description	4.8	4.8	4.8	4.8	4.8
Inrush current (capacitive) (A)					
Contact distance (mm)					
Contact material					
EN 60335 cap. 30 conform "G"					
Miscellaneous		VDE	VDE	VDE	size basic type 1805 VDE
Stock version		○	○		

ROCKERSWITCHES

PUSHBUTTON SWITCHES

TOGGLE SWITCHES

SLIDE SWITCHES

ROTARY SWITCHES

FOOT SWITCHES

TACT AND KEY SWITCHES

SNAP-ACTION SWITCHES

MIKRO-SIGNALSCHALTER

SENSORS

ECO

PUSH'N'DRIVE



SERIES 1800 - SINGLE AND DOUBLE-POLE ROCKER SWITCHES

T0 12 (4) A 250 V AC



Basic types 1801
single-pole
illuminated / non-illuminated

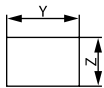

X = Wall thickness

x	y	z
0.75 ... 1.25	19.2 ^{-0.1}	12.9 ^{+0.1}
1.25 ... 2	19.4 ^{-0.1}	12.9 ^{+0.1}
2 ... 3	19.8 ^{-0.1}	12.9 ^{+0.1}

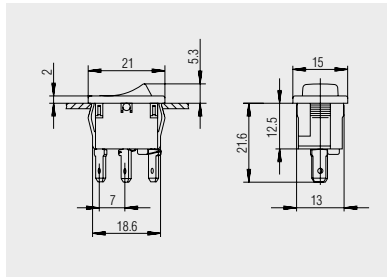

Quick-connect terminal 4.8 x 0.8
basic type 1800

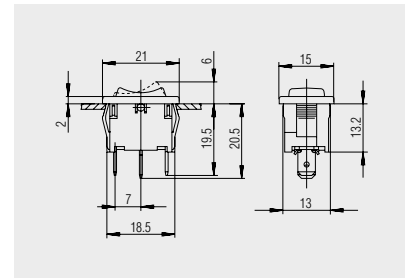

Quick-connect terminal 4.8 x 0.8
basic type 1808

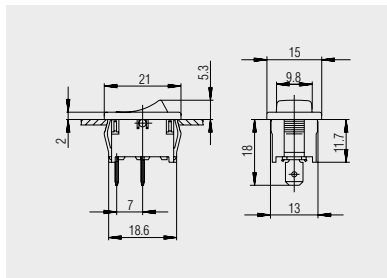

Quick-connect terminal 4.8 x 0.8
basic types 1801 and 1803

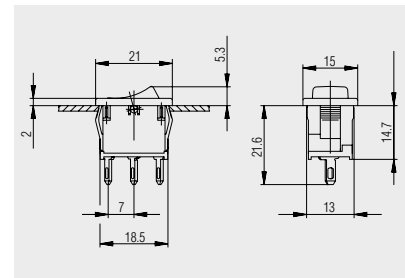

Solder terminal
basic type 1800

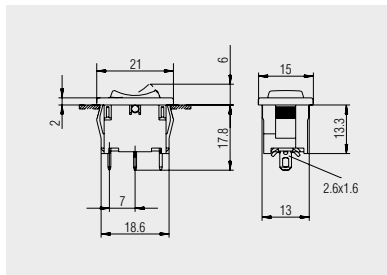

Solder terminal
basic type 1808

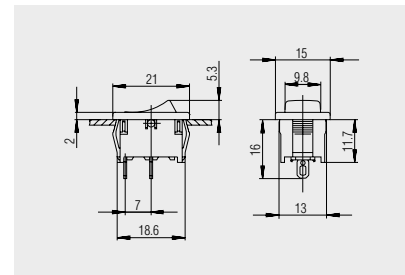

Solder terminal
basic types 1801 and 1803

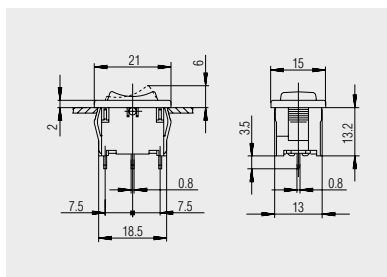

PCB terminal
basic type 1808

ROCKER SWITCHES

PUSHBUTTON SWITCHES

TOGGLE SWITCHES

SLIDE SWITCHES

ROTARY SWITCHES

FOOT SWITCHES

TACT AND KEY SWITCHES

SNAP-ACTION SWITCHES

MICRO-SIGNAL SWITCHES

SENSORS

ECO

PUSH 'N' DRIVE



SERIES 1800 - SINGLE AND DOUBLE-POLE ROCKER SWITCHES

TO 12 (4) A 250 V AC



Basic types 1802, 1804 and 1805
double-pole
illuminated / non-illuminated

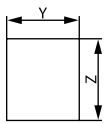

X = Wall thickness

x	y	z
0.75 ... 1.25	19.2 ^{-0.1}	21.9 ^{+0.1}
1.25 ... 2	19.4 ^{-0.1}	21.9 ^{+0.1}
2 ... 3	19.8 ^{-0.1}	21.9 ^{+0.1}

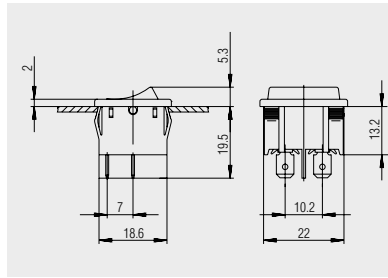

Quick-connect terminal 4.8 x 0.8
basic type 1805

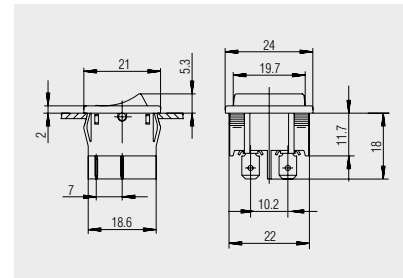

Quick-connect terminal 4.8 x 0.8
basic types 1802 and 1804

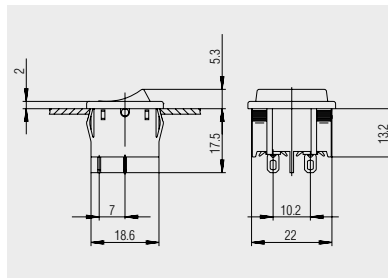

Solder terminal
basic type 1805

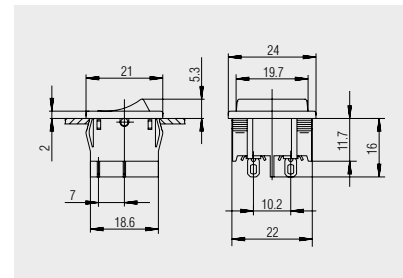

Solder terminal
basic types 1802 and 1804

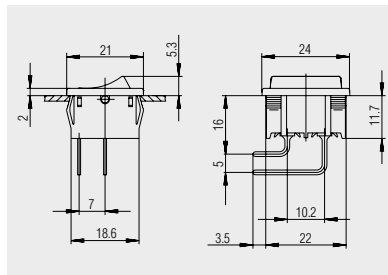

PCB terminal angled

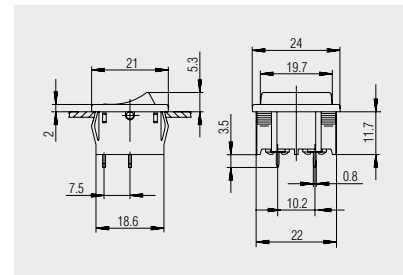

PCB terminal
basic types 1802 and 1804

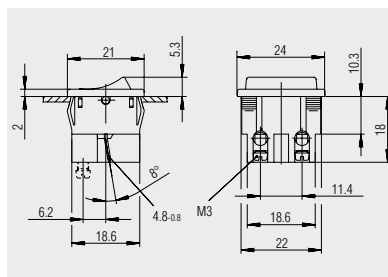

Terminal 1 2
Quick-connect terminal 4.8 x 0.8
Terminal 1a 2a
Socket terminal M3
1802.3102

ROCKERSWITCHES

PUSHBUTTON SWITCHES

TOGGLE SWITCHES

SLIDE SWITCHES

ROTARY SWITCHES

FOOT SWITCHES

TACT AND KEY SWITCHES

SNAP-ACTION SWITCHES

MICRO-SIGNAL SWITCHES

SENSORS

ECO

PUSH'N'DRIVE



SERIES 1800 - SINGLE AND DOUBLE-POLE ROCKER SWITCHES

TO 12 (4) A 250 V AC



Basic type 1809
double-pole
non-illuminated

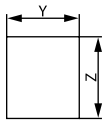

X = Wall thickness

x	y	z
0.75 ... 1.25	19.2 ^{-0.1}	21.9 ^{+0.1}
1.25 ... 2	19.4 ^{-0.1}	21.9 ^{+0.1}
2 ... 3	19.8 ^{-0.1}	21.9 ^{+0.1}

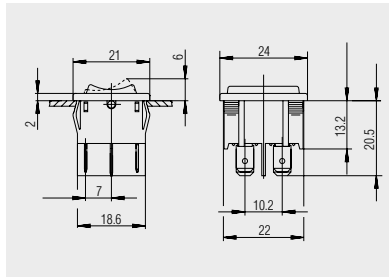

Quick-connect terminal 4.8 x 0.8

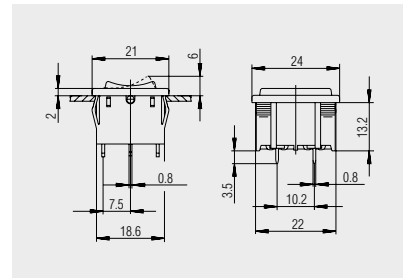

PCB terminal



Basic type 1806
combination

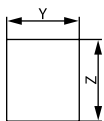

X = Wall thickness

x	y	z
0.75 ... 1.25	19.2 ^{-0.1}	21.9 ^{+0.1}
1.25 ... 2	19.4 ^{-0.1}	21.9 ^{+0.1}
2 ... 3	19.8 ^{-0.1}	21.9 ^{+0.1}

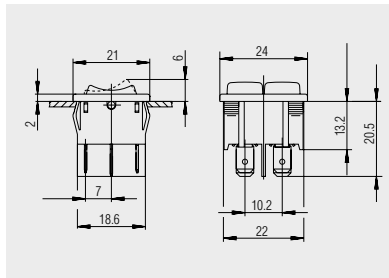

Quick-connect terminal 4.8 x 0.8
1806.1102

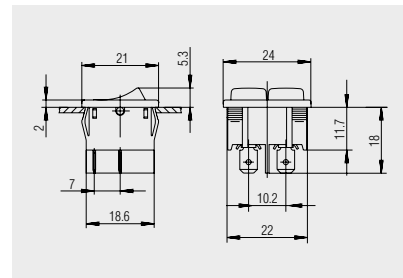

Quick-connect terminal 4.8 x 0.8
1806.1602

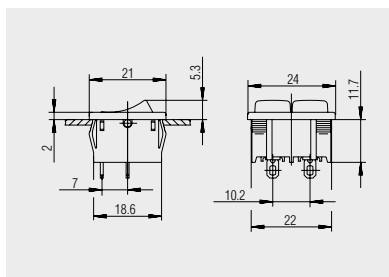

Solder terminal
1806.6108

ROCKER SWITCHES
PUSHBUTTON SWITCHES
TOGGLE SWITCHES
SLIDE SWITCHES
ROTARY SWITCHES
FOOT SWITCHES
TACT AND KEY SWITCHES
SNMP-ACTION SWITCHES
MICRO-SIGNAL SWITCHES
SENSORS
ECO
PUSH'N'DRIVE



SERIES 1800 - SINGLE AND DOUBLE-POLE ROCKER SWITCHES

TO 12 (4) A 250 V AC

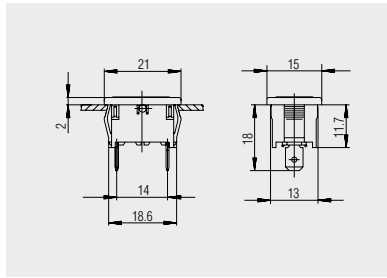

Basic type 1807 lamp

Quick-connect terminal 4.8 x 0.8

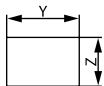

X = Wall thickness

x	y	z
0.75 ... 1.25	19.2 ^{-0.1}	12.9 ^{+0.1}
1.25 ... 2	19.4 ^{-0.1}	12.9 ^{+0.1}
2 ... 3	19.8 ^{-0.1}	12.9 ^{+0.1}

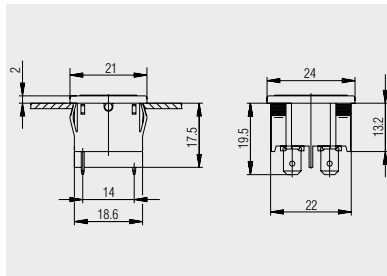

Basic type 1807 lamp

Quick-connect terminal 4.8 x 0.8

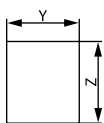

X = Wall thickness

x	y	z
0.75 ... 1.25	19.2 ^{-0.1}	21.9 ^{+0.1}
1.25 ... 2	19.4 ^{-0.1}	21.9 ^{+0.1}
2 ... 3	19.8 ^{-0.1}	21.9 ^{+0.1}



SERIES 1800 - SINGLE AND DOUBLE-POLE ROCKER SWITCHES

TO 12 (4) A 250 V AC



Protection cap
203.089.011

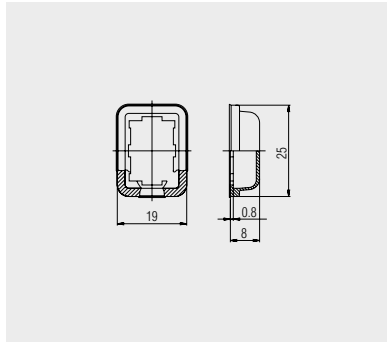

Transparent PVC-protection cap for single-pole switches of basic types 1800, 1801, 1803 and 1808. Serves as dust and water protection of the actuation side.



Protection cap
203.090.011

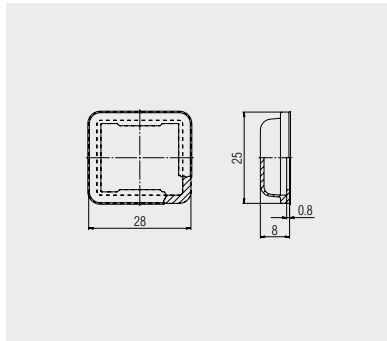

Transparent PVC-protection cap for double-pole switches of basic types 1802, 1804, 1805 and 1809. Serves as dust and water protection of the actuation side.



Dummy piece
203.086.013

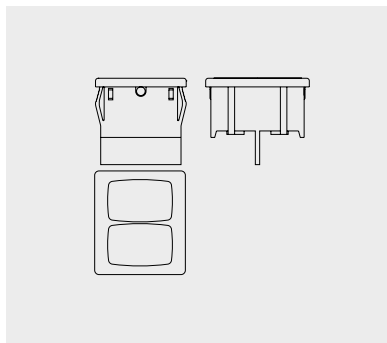

Dummy piece for size of basic type 1802, 1804, 1805, 1806, 1807 and 1809 made of PA with window and housing in black



Dummy piece
203.007.013
203.007.023 - V0 material

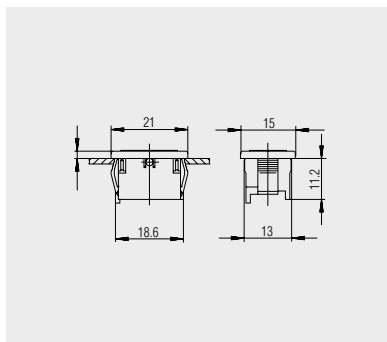

Dummy piece for size of basic type 1800, 1801, 1803, 1807, 1808, 1811, 1813, 1818, 1846, 1850 and 1858 made of PA with window and housing in black

	1	2	3	4	
A	Empfohlener Ausschnitt für Rastbefestigung (Grat gegenüber Bestückungsseite) recommended cut-out for snap-in fixing (edge opposite to snap-in direction)		Wanddicke wall thickness	Ausschnittlänge length of cut-out	Ausschnittbreite width of cut-out
			0.75 bis / to 1.25	19.2 -0.1	12.9 +0.1
			1.25 bis / to 2	19.4 -0.1	12.9 +0.1
			2 bis / to 3	19.8 -0.1	12.9 +0.1

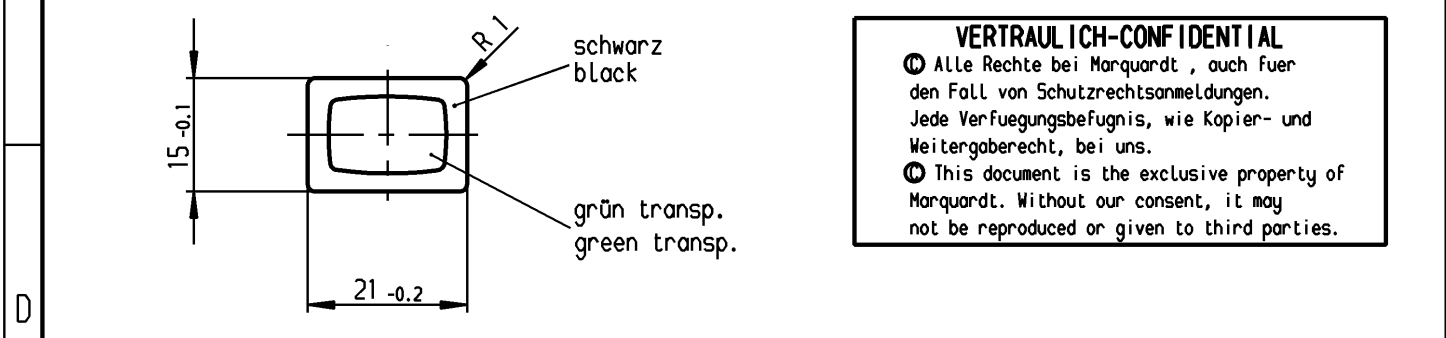
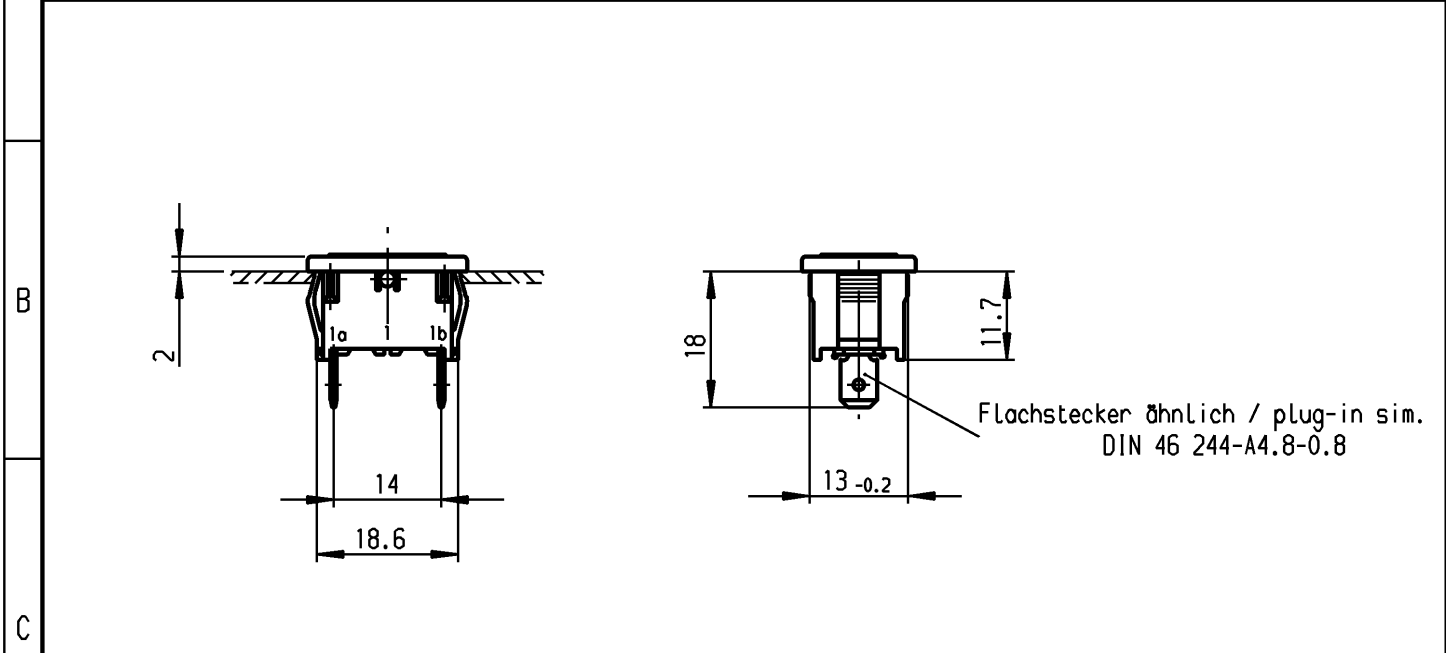

VERTRAULICH-CONFIDENTIAL

© Alle Rechte bei Marquardt, auch fuer den Fall von Schutzrechtsanmeldungen. Jede Veruegungsbefugnis, wie Kopier- und Weitergaberecht, bei uns.

© This document is the exclusive property of Marquardt. Without our consent, it may not be reproduced or given to third parties.



E

Aufschrift
Marking

Ⓜ
1807.
230V ~ T85°C

230V AC

UL Ⓢ

Leuchte
Glimmlampe mit R_v für 230V ~
Für Geräte der Klasse II geeignet

Pilot Light
neon lamp with R_v for 230V AC
suitable for appliances of class II

Herstellort /-jahr/-woche nach DIN EN 60062
date of manufacture: place/year/week acc. to DIN EN 60062

Schutzvermerk nach DIN 34 beachten
COPYRIGHT RESERVED

Allgemeintoleranzen/UNTOLERANCED DIMENSIONS				PROJECTION		Pause COPY		Blatt von SHEET OF		Zeichn./DRAWING NO.	
Für Längen und Radien FOR LENGTHS AND RADII.	Abmaße in mm für Nennmaßbereich in mm ALL DIMENSIONS ARE IN MILLIMETRES					Original DIN A4 Maßstab SCALE 1:1		K		1807.1108	
	bis/UP TO 6	über/OVER 6 bis/UP TO 30	über/OVER 30								
	± 0.2	0.4									
d	47974	26.06.06 vor	i		0 10 20 30 mm				Leuchte Pilot Light		
c	22679	24.02.94 Hs	h		gez./DRAWN BY 24.02.94 Hs						
b	17910	06.04.87 ZF	g		gepr./CHECKED BY Kiz						
a			f								
			e	64492	15.10.09 Mut	Ersatz für/REPLACEMENT OF Zeichng. gl. Nr. v. 19.05.78				 Marquardt, D-78604 Rietheim-Weilheim	
Ausg. ISSUE	Änderung REVISION	gez. DRAWN BY	Ausg. ISSUE	Änderung REVISION	gez. DRAWN BY						