



SERIES 1050 - SUBMINIATURE SNAP-ACTION SWITCHES

TO 10 (1.5) A 250 V AC



PRODUCT FEATURES

- Small, efficient snap-action switches up to 10 (1.5) A 250 V AC or 10.1 A 125 - 250 V AC 1/4 HP
- Lateral approach from both directions possible due to mushroom-shaped actuator
- Large selection of auxiliary actuators of chrome-nickel steel and plastic

ON REQUEST

- Extended overtravel
- Material conformant with the filament wire test acc. to IEC 60335-1:2001 chap. 30
- Increased or reduced difference travel
- Other operating forces and ratings
- Gold-plated contacts

Design	DIN 41635 B
Mechanical life endurance	10E6 1E6 (versions with auxiliary actuator)
Contact resistance (new condition)	< 100 mOhm (1 A 12 V DC)
Insulation resistance (new condition)	> 100 MOhm (500 V DC)
Proof tracking	175 PTI
Protection type	IP 40 (actuator side)
Ambient temperature	-40 °C ... +100 °C
Flammability	UL 94 V-2
Glow wire test temperature	850 °C
Material	additional actuator housing terminals
	PA glass fiber-reinforced / stainless steel spring steel PBTP tinned / silver plated / blank (product-dependent)
Bounce time	< 5 ms
Approval marks	
Suitable for appliances of protection class II under compliance with the installation conditions required on the equipment side	

ROCKERSWITCHES
 PUSHBUTTON SWITCHES
 TOGGLE SWITCHES
 SLIDE SWITCHES
 ROTARY SWITCHES
 FOOT SWITCHES
 TACT AND KEY SWITCHES
 SNAP-ACTION SWITCHES
 MICRO-SIGNAL SWITCHES
 SENSORS
 ECO
 PUSH N' DRIVE



SERIES 1050 - SUBMINIATURE SNAP-ACTION SWITCHES

TO 10 (1.5) A 250 V AC

		10 (1.5) A 250 V AC 1E4	5 A 250 V AC 5E4	2 (0.5) A 250 V AC 25E3	10.1 A 125 - 250 V AC 1/4 HP	5 A 125 - 250 V AC 1/10 HP	2 A 125 - 250 V AC	Terminal type	Terminal description	Contact material	Operating force (N)	Operating position (OP) (mm)	Difference travel max. (mm)	Free position (FP) max. (mm)	Permissible total travel position (TP) (mm)	Actuator description	Lever drawing	Miscellaneous	Stock version
Normally closed contact (SPNC)																			
1050.1142		○				○			2.8 x 0.5	Ag	≤ 1.5	8.4 ± 0.3	0.2	9.3	7.5				
Normally open contact (SPNO)																			
1050.0122		○				○				Ag	≤ 1.5	8.4 ± 0.3	0.2	9.3	7.5				○
1050.1122		○				○			2.8 x 0.5	Ag	≤ 1.5	8.4 ± 0.3	0.2	9.3	7.5				○
1050.2122		○				○			sealed	Ag	≤ 1.5	8.4 ± 0.3	0.2	9.3	7.5				
1050.1426									2.8 x 0.5	Ag	≤ 1.5	9.9 ± 0.3	0.2	10.8	8.6			greater overtravel without approval mark	
Changeover switch (SPDT momentary)																			
1050.0103		○				○				Ag	≤ 2.2	8.4 ± 0.3	0.2	9.3	7.5				○
1050.2403		○				○			sealed	Ag	≤ 2.2	8.4 ± 0.3	0.1	9.3	7			greater overtravel	
1050.0102		○				○			sealed	Ag	≤ 1.5	8.4 ± 0.3	0.2	9.3	7.5				○
1050.0202		○				○				Ag	≤ 1.5	9.9 ± 0.3	0.2	10.8	9.1				○
1050.0802		○				○				Ag	≤ 5	9.9 ± 0.3	0.2	10.8	9.3			foam sealing ring around pushbutton	
1050.1102		○				○			2.8 x 0.5	Ag	≤ 1.5	8.4 ± 0.3	0.2	9.3	7.5				○
1050.1202		○				○			2.8 x 0.5	Ag	≤ 1.5	9.9 ± 0.3	0.2	10.8	9.1				○
1050.2102		○				○			sealed	Ag	≤ 1.5	8.4 ± 0.3	0.2	9.3	7.5				○
1050.2202		○				○			sealed	Ag	≤ 1.5	9.9 ± 0.3	0.2	10.8	9.1				○
1050.3102		○				○				Ag	≤ 1.5	8.4 ± 0.3	0.2	9.3	7.5			fixing pin	○
1050.4102		○				○				Ag	≤ 1.5	8.4 ± 0.3	0.2	9.3	7.5			fixing pin	○
1050.5202		○				○			sealed	Ag	≤ 0.5	11.1 ± 1.5	1.0	15	7.4		L02		○
1050.5702		○				○			sealed	Ag	≤ 0.6	16.2 ± 1.5	1.0	20	13		L12		○
1050.6702		○				○			2.8 x 0.5	Ag	≤ 0.6	16.2 ± 1.5	1.0	20	13		L12		○
1050.7202		○				○			sealed	Ag	≤ 0.5	11.1 ± 1.5	1.0	15	7.4		L02		○
1050.7702		○				○			sealed	Ag	≤ 0.6	16.2 ± 1.5	1.0	20	13		L12		○
1050.0151			○			○			sealed	Au	≤ 1.5	8.4 ± 0.3	0.2	9.3	7.5				○
1050.1151			○			○			2.8 x 0.5	Au	≤ 1.5	8.4 ± 0.3	0.2	9.3	7.5				○
1050.2151			○			○			sealed	Au	≤ 1.5	8.4 ± 0.3	0.2	9.3	7.5				○
1050.5251			○			○			sealed	Au	≤ 0.5	11.1 ± 1.5	1.0	15	7.4		L02		○
1050.5305			○			○			sealed	Au	≤ 0.6	16.6 ± 0.2	1.0	20	13.6		L43		○



SERIES 1050 - SUBMINIATURE SNAP-ACTION SWITCHES

TO 10 (1.5) A 250 V AC



Terminal variants

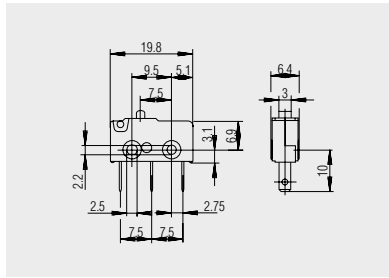

Quick-connect terminal 2.8 x 0.5

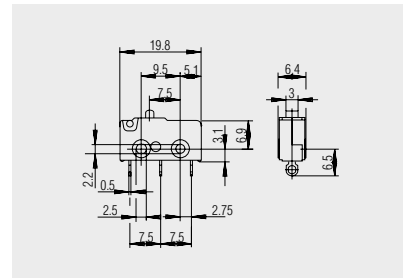

Solder terminal

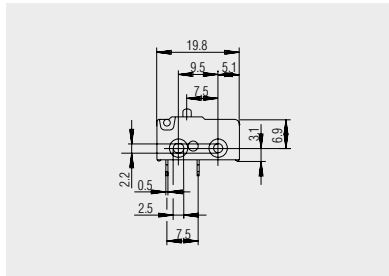

Solder terminal normally open contact version

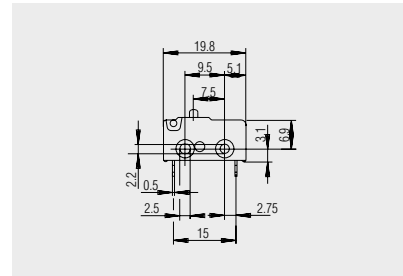

Solder terminal normally closed contact version

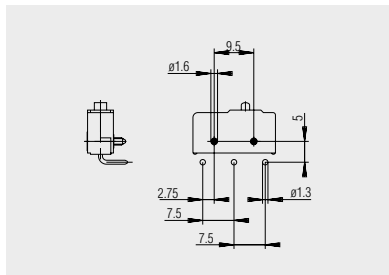

PCB terminal (cover side) right angled

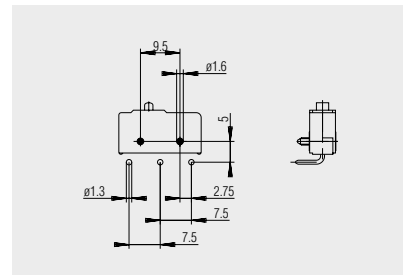

PCB terminal (base side) left angled

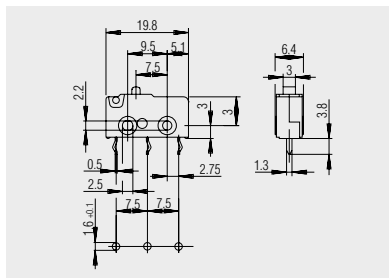

PCB terminal sealed

ROCKER SWITCHES
PUSHBUTTON SWITCHES
TOGGLE SWITCHES
SLIDE SWITCHES
ROTARY SWITCHES
FOOT SWITCHES
TACT AND KEY SWITCHES
SNAP-ACTION SWITCHES
MICRO-SIGNAL SWITCHES
SENSORS
ECO
PUSH N'DRIVE



SERIES 1050 - SUBMINIATURE SNAP-ACTION SWITCHES

TO 10 (1.5) A 250 V AC

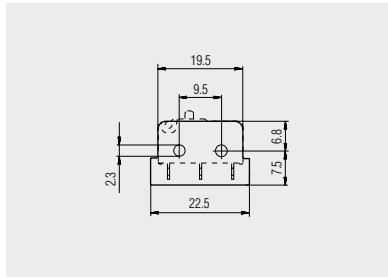

Additional parts

Insulating plate for solder terminal
0.5 mm: 231.005.021

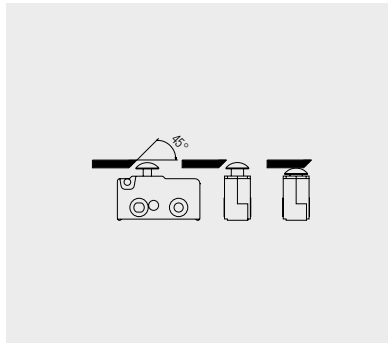

Mushroom-shaped actuator

The mushroom-shaped actuator allows, in addition to the vertical actuation from above, lateral approach from any direction. In such application cases, an angle of 45° is necessary on the actuating element (angle for versions with extended overtravel on request). To keep the friction here to a minimum, we recommend the use of materials with a low friction coefficient in relation to the material PA. In addition, the surface of the actuating element should be free from valleys. The mechanical life endurance depends on the material and surface properties as well as on the form of the slide.



SERIES 1050 - SUBMINIATURE SNAP-ACTION SWITCHES

TO 10 (1.5) A 250 V AC



Switching positions

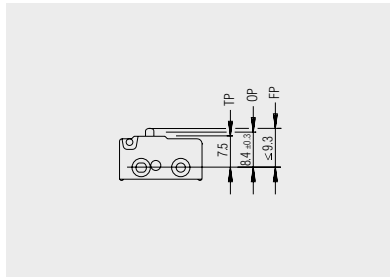

Standard actuator

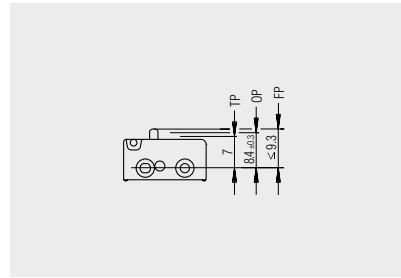

Standard actuator and extended overtravel

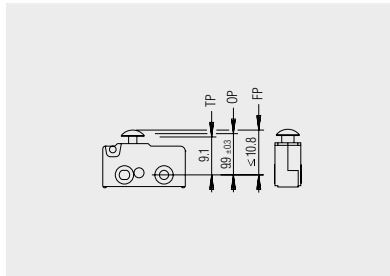

Mushroom-shaped actuator

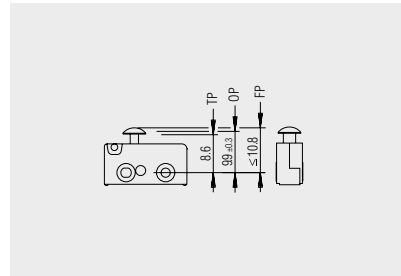

Mushroom-shaped actuator and extended overtravel

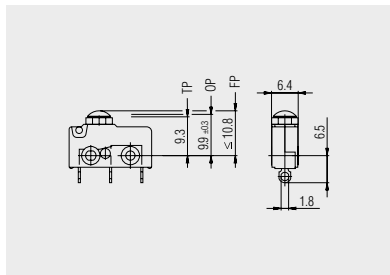

Mushroom-shaped actuator with foam sealing ring

ROCKER SWITCHES

PUSHBUTTON SWITCHES

TOGGLE SWITCHES

SLIDE SWITCHES

ROTARY SWITCHES

FOOT SWITCHES

TACT AND KEY SWITCHES

SNAP-ACTION SWITCHES

MICRO-SIGNAL SWITCHES

SENSORS

ECO

PUSH 'N' DRIVE



SERIES 1050 - SUBMINIATURE SNAP-ACTION SWITCHES

TO 10 (1.5) A 250 V AC



Auxiliary actuators

The auxiliary actuators are available as additional parts for later assembly or are already pre-assembled depending on the product. In the adjustable versions the operating position can be set application-specifically by the set screw.

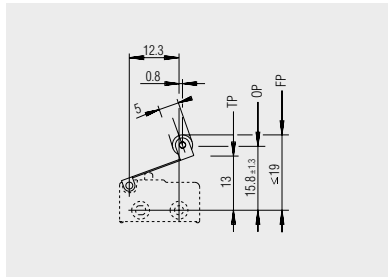

L11: roller lever
191.078.013

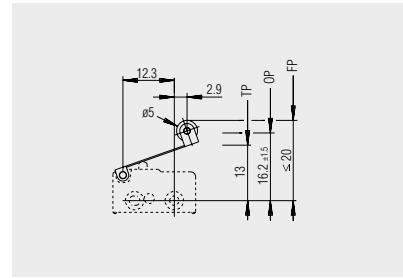

L12: roller lever
191.078.023

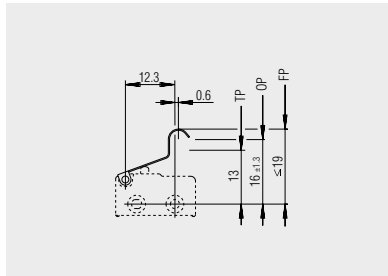

L21: simulated roller
191.071.041

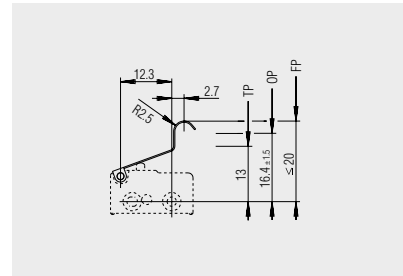

L22: simulated roller
191.071.051

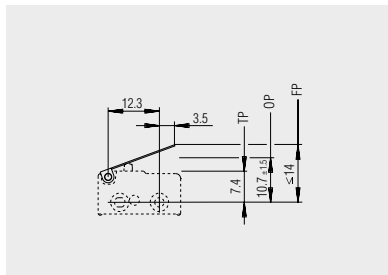

L01: straight lever
191.071.011

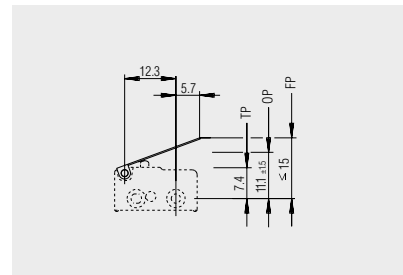

L02: straight lever
191.071.021

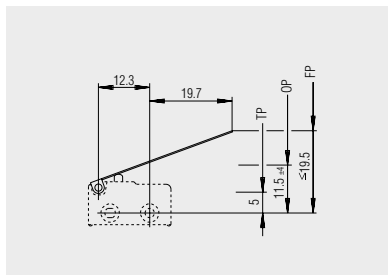

L03: straight lever
191.071.101

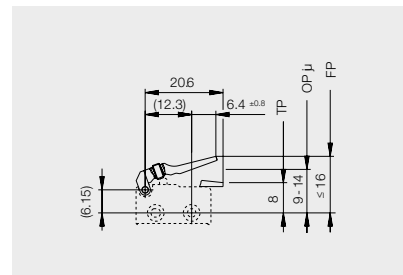

L41: adjustable plastic lever
190.075.013

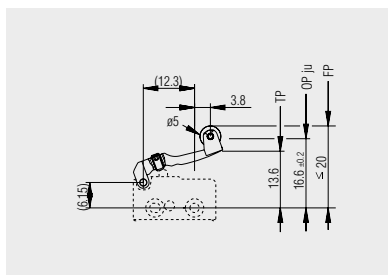

L43: adjustable roller lever
190.072.013

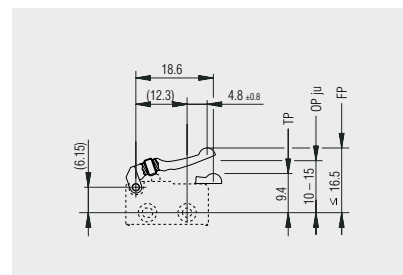

L45: adjustable simulated roller
190.074.013

ROCKERSWITCHES

PUSHBUTTON SWITCHES

TOGGLE SWITCHES

SLIDE SWITCHES

ROTARY SWITCHES

FOOT SWITCHES

TACT AND KEY SWITCHES

SNAP-ACTION SWITCHES

MICRO-SIGNAL SWITCHES

SENSORS

ECO

PUSH'N'DRIVE

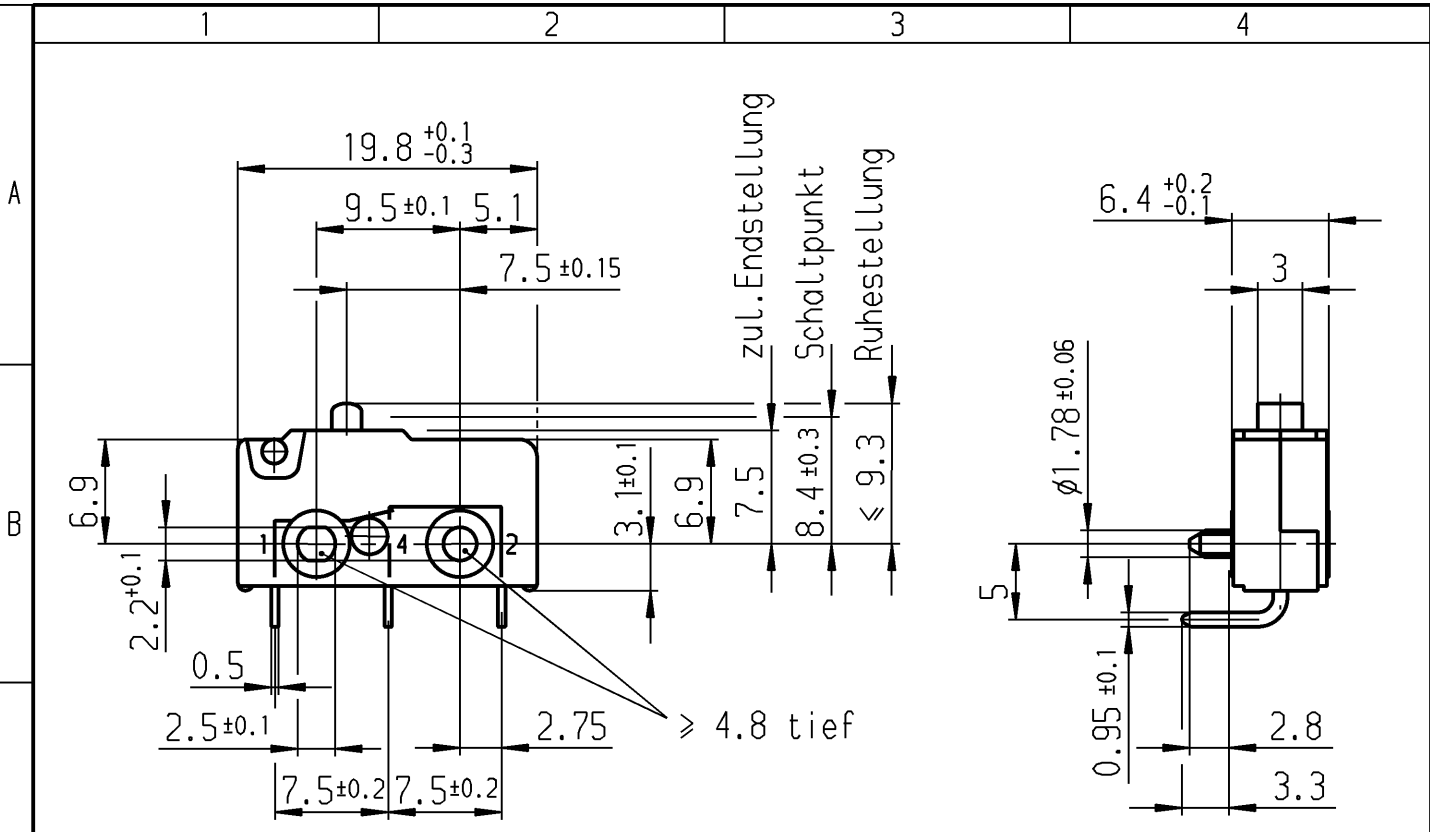

Empfohlenes Lochbild
 Bestückungsseite
 Toleranzen nach DIN IEC 326
 Teil 3 sehr fein

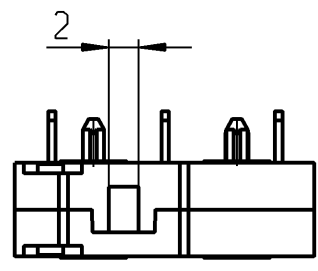

- Fixierloch $\varnothing 1.6^{+0.1}$
- Anschlußloch $\varnothing 1.3^{+0.1}$

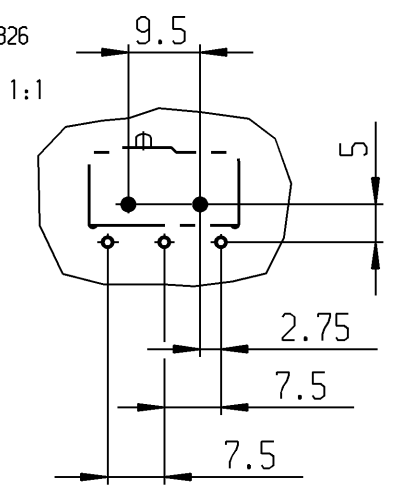

Aufschrift

Ⓜ
 1050 μ
 5/250~
 50E3 T100 
 5A 125-250V AC 1/10HP
 R 56  
 Herstelljahr/-woche
 nach DIN EN 60062

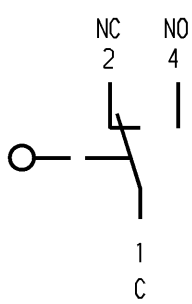

Wechsler 1-polig

- Schalt-Betätigungskraft ≤ 1.50 N
- Rückschaltkraft ≥ 0.50 N
- Differenzweg ≤ 0.20 mm

Schutzvermerk nach DIN 34 beachten COPYRIGHT RESERVED

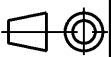
Allgemeintoleranzen/UNTOLERANCED DIMENSIONS				PROJECTION		Pause COPY	Blatt von SHEET OF		Zeichn./DRAWING NO.
Für Längen und Radien FOR LENGTHS AND RADII.	Abmaße in mm Für Nennmaßbereich in mm ALL DIMENSIONS ARE IN MILLIMETRES						Original DIN A4	Maßstab SCALE	
	\pm	bis/UP TO 6	über/OVER 6 bis/UP TO 30			über/OVER 30		2:1	
d				i		0 10 20 30 mm		Schnappschalter	
c				h		gez./DRAWN BY 22.11.93 mk			
b	29551	21.06.00	pfu	g		Ersatz für/REPLACEMENT OF			
a	0	07.04.94	mk	f		MARQUARDT Marquardt GmbH, D-78604 Riethim-Weilheim			
Ausg. ISSUE	Änderung REVISION	gez. DRAWN BY		Ausg. ISSUE	Änderung REVISION	gez. DRAWN BY			