



SERIES 2410 - ERGONOMIC FOOT SWITCHES

TO 6 (2.5) A 250 V AC



PRODUCT FEATURES

- Long life endurance up to 300 000 mechanical switching cycles
- Robust design
- Cable can be retrofitted by customer
- Ergonomical dimensions with different operating forces
- With wall hanger

ON REQUEST

- Other colors
- Customized cable assembly
- Special switching functions
- Other terminal variants

Mechanical life endurance	30E4
Proof tracking	250 PTI
Material actuator housing	PA PA
Approval marks	

ROCKER SWITCHES

PUSHBUTTON SWITCHES

TOGGLE SWITCHES

SLIDE SWITCHES

ROTARY SWITCHES

FOOT SWITCHES

TACT AND KEY SWITCHES

SNAP-ACTION SWITCHES

MICRO-SIGNAL SWITCHES

SENSORS









ECO





PUSH 'N' DRIVE











SERIES 2410 - ERGONOMIC FOOT SWITCHES

TO 6 (2.5) A 250 V AC

 single-pole	Actuator color / printing	Housing color	Terminal type	Terminal description	Contact distance (mm)	Contact material	Operating force (N)	Miscellaneous	Stock version
		6 (2.5) A 250 V AC 5E4							
Normally open contact (SPNO)									
2410.0301				2 terminals M3	< 3	Ag	31 ± 5	with switch 1005.1801	
Changeover switch (SPDT momentary)									
2410.0401				M3 3 terminals	< 3	Ag	31 ± 5	with switch 1005.1407	

 double-pole	Actuator color / printing	Housing color	Terminal type	Terminal description	Contact distance (mm)	Contact material	Operating force (N)	Miscellaneous	Stock version
		6 (2.5) A 250 V AC 5E4							
Normally open contact (DPNO)									
2410.1001				assembled	≥ 3	Ag	45 ± 7 N	1 x PE connector (3 000 mm) / 1 x PE coupling (250 mm) 2 x 1005.1802	

 Combination	Actuator color / printing	Housing color	Terminal type	Terminal description	Contact distance (mm)	Contact material	Operating force (N)	Miscellaneous	Stock version
		6 (2.5) A 250 V AC 5E4							
Normally closed contact (SPNC) / Changeover switch (SPDT momentary)									
2410.0101				M3 3 terminals	< 3	Ag	step 1: 25 ± 5 N / step 2: 85 ± 15 N	with switch 1005.1407 with switch 1005.1501 switching in sequence	
Normally open contact (SPNO) / Changeover switch (SPDT momentary)									
2410.0501				M3 5 terminals	< 3	Ag	step 1: 22 N ± 4 / step 2: 31 ± 5 N	with switch 1005.1407 with switch 1005.1801 switching in sequence Changeover switch and normally open contact can be connected separately	

ROCKERSWITCHES

PUSHBUTTON SWITCHES

TOGGLE SWITCHES

SLIDE SWITCHES

ROTARY SWITCHES

FOOT SWITCHES

TACT AND KEY SWITCHES

SNAP-ACTION SWITCHES

MICRO-SIGNAL SWITCHES

SENSORS

ECO

PUSH'N'DRIVE



SERIES 2410 - ERGONOMIC FOOT SWITCHES

TO 6 (2.5) A 250 V AC

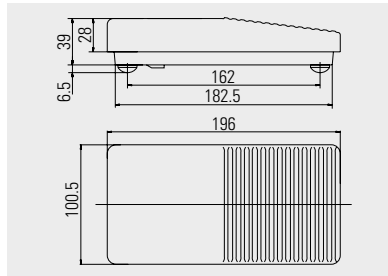

Basic type 2410

Socket terminal
2 terminals M3

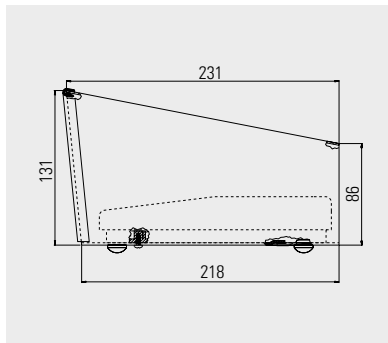

Protection hood
248.008.013

Steel plate protection hood in orange color similar to RAL 2004 with edge guard and rubber feet as well as fixation for foot switch of the basic type 2410

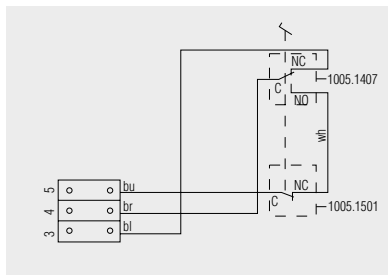

2410.0101

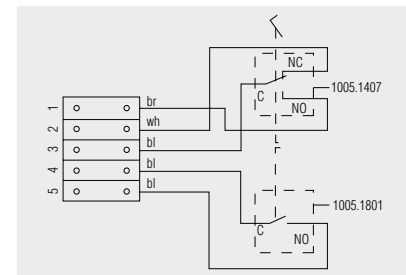

2410.0501

Circuit diagram

- bu - blue
- br - brown
- bl - black
- wh - white
- C - common terminal
- NC - normally closed contact
- NO - normally open contact

ROCKER SWITCHES
PUSHBUTTON SWITCHES
TOGGLE SWITCHES
SLIDE SWITCHES
ROTARY SWITCHES
FOOT SWITCHES
TACT AND KEY SWITCHES
SNAP-ACTION SWITCHES
MICRO-SIGNAL SWITCHES
SENSORS
ECO
PUSH-IN DRIVE

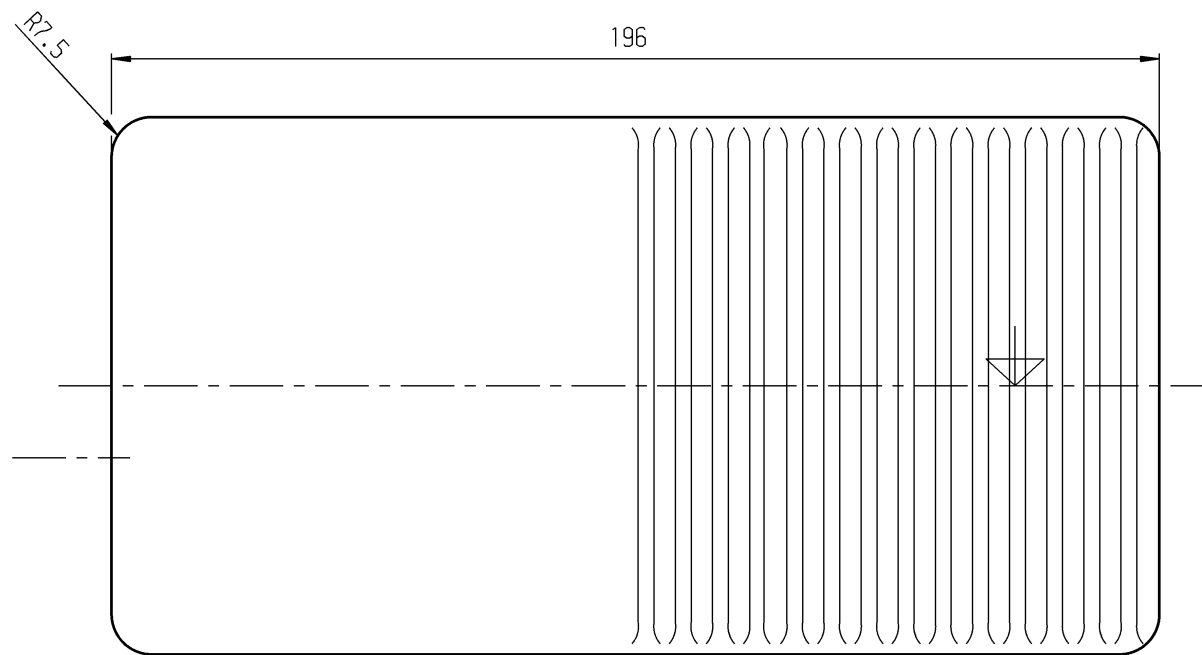
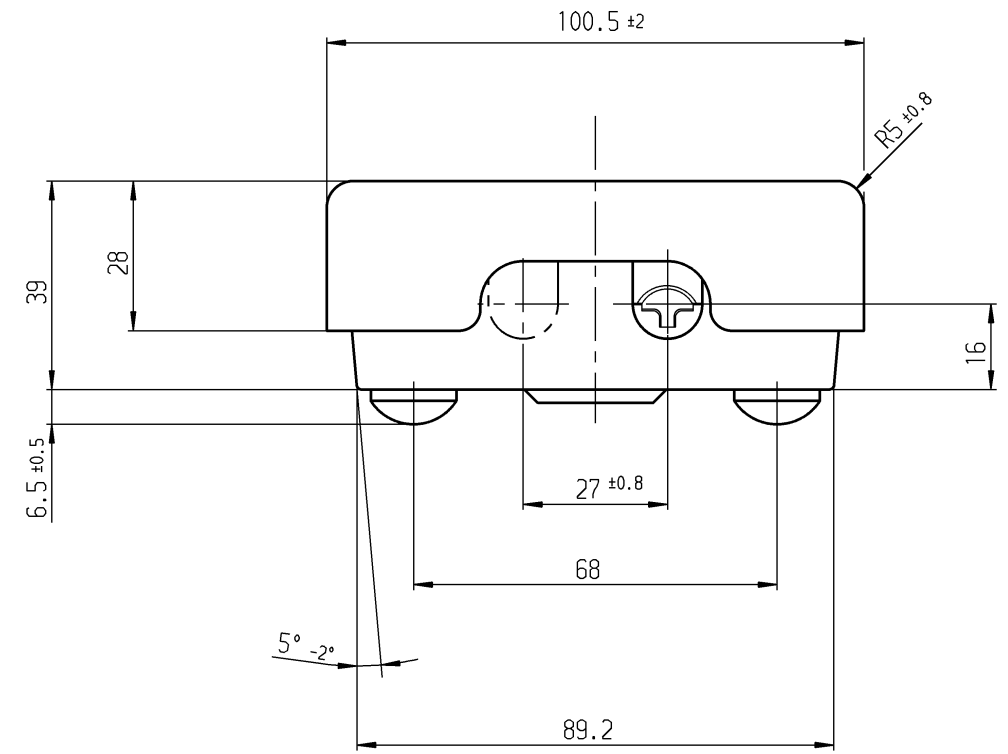
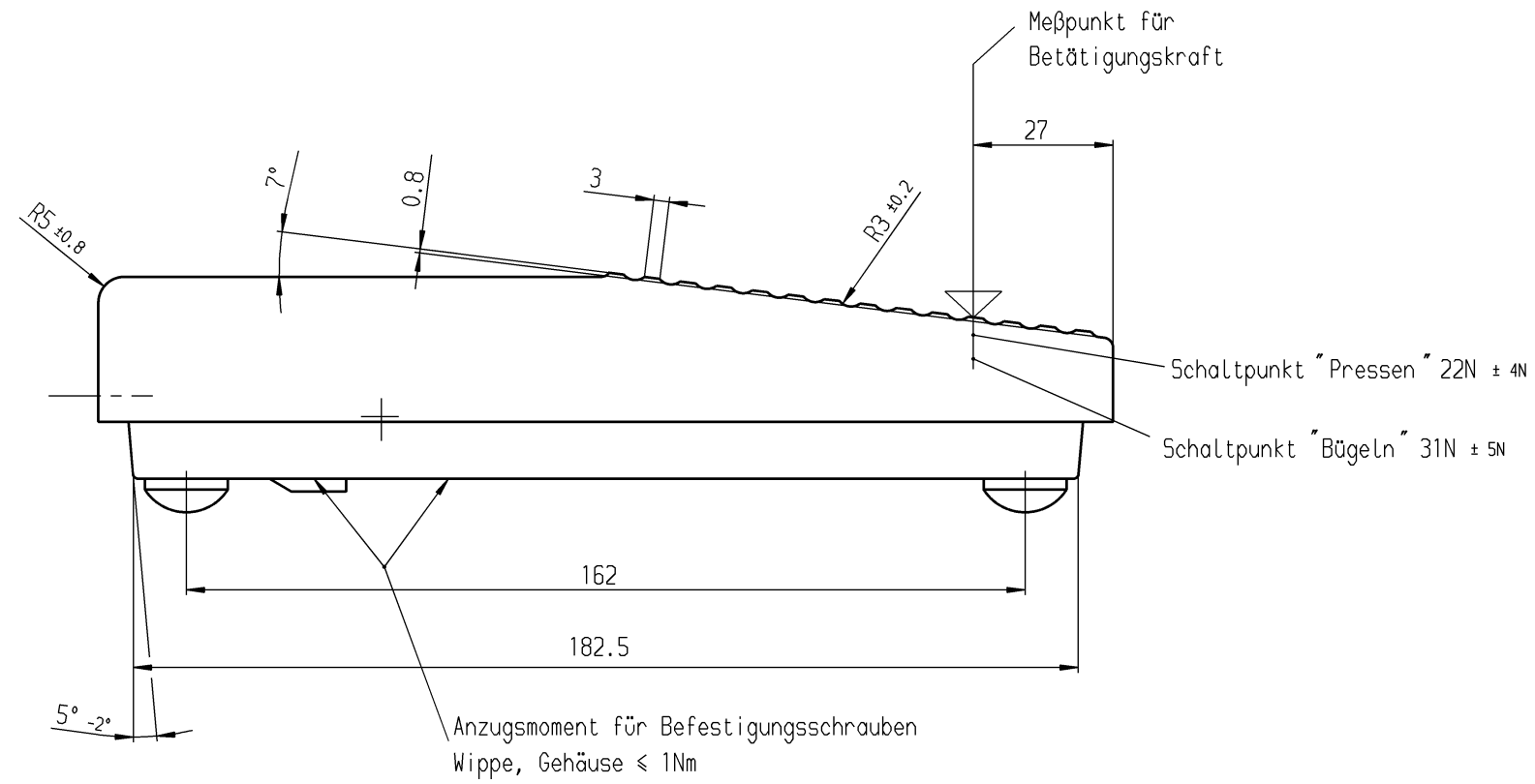

Schaltbild

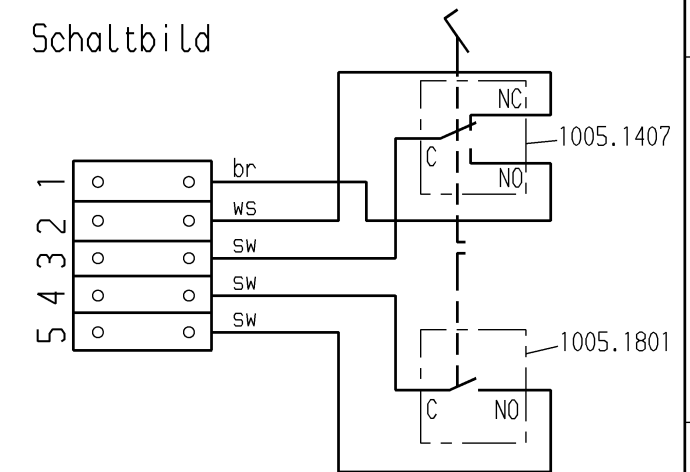

Wechsler 1-polig,
Schließer 1-polig,

Aufschrift:

MARQUARDT
2410.0501 μ
6 (2.5) / 250 ~ 50E3

Schaltbild

Schaltpunkt "Pressen" (gemessen von Ausgangsstellung) ≈ 2.3 mm
Schaltpunkt "Bügel" (gemessen von Ausgangsstellung) ≈ 8 mm } gemessen an der äußersten Kante des Oberteils

Allgemeintoleranzen/UNTOLERANCED DIMENSIONS				PROJECTION		Pause COPY		Blatt SHEET		Zeichn./DRAWING NO.	
Für Längen und Radien FOR LENGTHS AND RADII.		Abmaße in mm für Nennmaßbereich in mm ALL DIMENSIONS ARE IN MILLIMETRES		FIRST ANGLE		0 10 20 30 mm		Original DIN A2 Maßstab SCALE 1:1		K 2410.0501	
±		bis/UP TO 6	über/OVER 6 bis/UP TO 30	über/OVER 30						Fußdruckschalter	
e	23889	08.05.96	Moo	k							
d	23493	28.04.94	vn	i							
c	20708	15.03.91	Moo	h							
b				g	41282	13.10.04	bz				
a				f	30220	28.09.00	pfu				
ISSUE	Anderung REVISION	gez. DRAWN BY		Ausg. ISSUE	Anderung REVISION	gez. DRAWN BY				Ersatz für/REPLACEMENT OF Zchnng. gl. Nr. v. 01.03.68	
Schutzvermerk nach DIN 34 beachten COPYRIGHT RESERVED										MARQUARDT Marquardt GmbH, D-78604 Rietheim-Weilheim	