

## Features

- 1.0W Power Dissipation
- Ideally Suited for Automated Assembly
- 5.1V - 39V Nominal Zener Voltage Range
- Standard  $V_Z$  Tolerance is  $\pm 5\%$
- **Lead Free Finish/RoHS Compliant (Note 1)**
- **Green Molding Compound (No Halogen and Antimony) (Note 2)**

## Mechanical Data

- Case: SMA
- Case Material: Molded Plastic. UL Flammability Classification Rating 94V-0
- Moisture Sensitivity: Level 1 per J-STD-020D
- Terminals: Lead Free Plating (Matte Tin Finish). Solderable per MIL-STD-202, Method 208
- Polarity: Cathode Notch or Cathode Band
- Marking Information: See Page 3
- Ordering Information: See Page 3
- Weight: 0.064 grams (approximate)

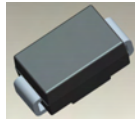

Top View

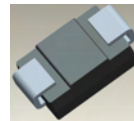

Bottom View

## Maximum Ratings @ $T_A = 25^\circ\text{C}$ unless otherwise specified

Characteristic	Symbol	Value	Unit
Forward Voltage @ $I_F = 200\text{mA}$	$V_F$	1.2	V
Zener Current (see Table page 2)	$I_{ZM}$	$P_D / V_Z$	mA

## Thermal Characteristics

Characteristic	Symbol	Value	Unit
Power Dissipation @ $T_A = 50^\circ\text{C}$	$P_D$	1.0	W
Derate Above $50^\circ\text{C}$ (Note 3)		8.0	mW/ $^\circ\text{C}$
Typical Thermal Resistance - Junction to Terminal (Note 3)	$R_{\theta JT}$	30	$^\circ\text{C}/\text{W}$
Typical Thermal Resistance - Junction to Ambient (Note 3)	$R_{\theta JA}$	125	$^\circ\text{C}/\text{W}$
Operating and Storage Temperature Range	$T_J, T_{STG}$	-65 to +150	$^\circ\text{C}$

- Notes:
1. EU Directive 2002/95/EC (RoHS). All applicable RoHS exemptions applied. Please visit our website at [http://www.diodes.com/quality/lead\\_free.html](http://www.diodes.com/quality/lead_free.html).
  2. No purposefully added lead. Halogen and Antimony free.
  3. Device mounted on FR-4 PCB, 1 inch x 0.85 inch x 0.062 inch; pad layout as shown on Diodes Inc. suggested pad layout document AP02001, which can be found on our website at <http://www.diodes.com/datasheets/ap02001.pdf>.

**Electrical Characteristics** @T<sub>A</sub> = 25°C unless otherwise specified

Type Number	Marking Code	Zener Voltage Range (Note 4)			Test Current	Maximum Zener Impedance			Maximum Reverse Current		I <sub>ZM Max</sub> (Note 3)
		V <sub>Z</sub> @ I <sub>ZT</sub>				Z <sub>ZT</sub> @ I <sub>ZT</sub>	Z <sub>ZK</sub> @ I <sub>ZK</sub>		I <sub>R</sub> @ V <sub>R</sub>		
		Nom (V)	Min (V)	Max (V)	mA	Ω	Ω	mA	μA	V	mA
SMAZ5V1	ZHK	5.1	4.84	5.40	100	5.0	500	1.0	2.5	1.0	196
SMAZ5V6	ZHL	5.60	5.32	5.88	100	2.0	250	2.0	5.0	2.0	179
SMAZ6V2	ZHN	6.20	5.89	6.51	100	2.0	200	2.0	5.0	3.0	161
SMAZ6V8	ZHO	6.80	6.46	7.14	100	2.0	200	1.0	5.0	4.0	147
SMAZ7V5	ZHQ	7.50	7.13	7.88	100	2.0	450	1.0	5.0	5.0	133
SMAZ8V2	ZHR	8.20	7.79	8.61	100	2.0	200	1.0	5.0	6.0	122
SMAZ9V1	ZHT	9.10	8.65	9.56	50	4.0	200	1.0	5.0	7.0	110
SMAZ10	ZHU	10.00	9.50	10.50	50	4.0	200	1.0	1.0	7.6	100
SMAZ12	ZHW	12.00	11.40	12.60	50	7.0	150	1.0	1.0	9.1	83
SMAZ15	ZHZ	15.00	14.25	15.75	50	10	150	1.0	1.0	11.4	67
SMAZ16	ZJA	16.00	15.20	16.80	25	15	150	1.0	0.5	12.2	63
SMAZ18	ZJF	18.00	17.10	18.90	25	15	150	1.0	0.5	13.7	56
SMAZ20	ZJG	20.00	19.00	21.00	25	15	180	1.0	0.5	15.2	50
SMAZ22	ZJK	22.00	20.90	23.10	25	15	180	1.0	0.5	16.7	45
SMAZ24	ZJL	24.00	22.80	25.20	25	15	180	1.0	0.5	18.2	42
SMAZ27	ZJN	27.00	25.65	28.35	25	15	200	1.0	0.5	20.5	37
SMAZ30	ZJQ	30.00	28.50	31.50	25	15	250	1.0	0.5	22.8	33
SMAZ33	ZJR	33.00	31.35	34.65	25	15	300	1.0	0.5	25.1	30
SMAZ36	ZJS	36.00	34.20	37.80	10	40	350	1.0	0.5	27.4	28
SMAZ39	ZJT	39.00	37.05	40.95	10	40	450	1.0	0.5	29.6	26

Notes: 4. Short duration pulse test used to minimize self-heating effect.

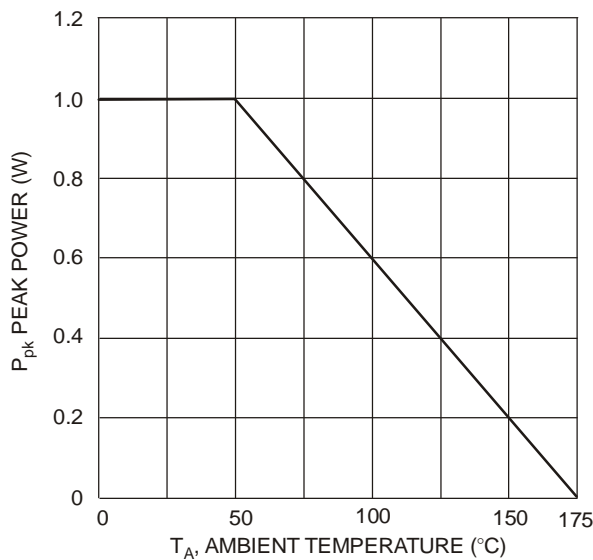

Fig. 1 Power Dissipation vs. Ambient Temperature

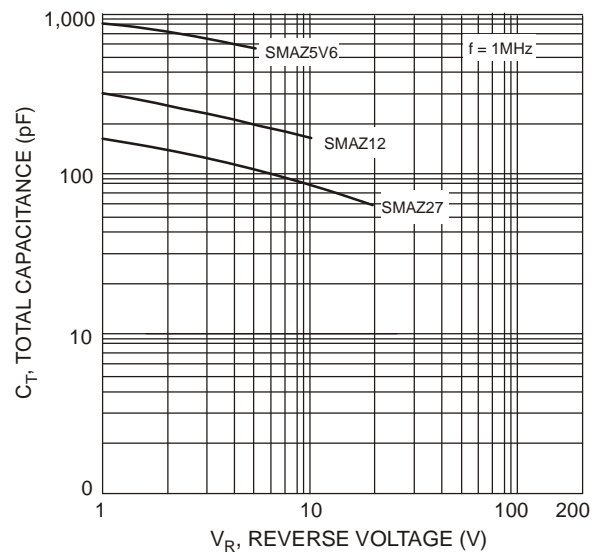

Fig. 2 Typical Total Capacitance vs. Reverse Voltage

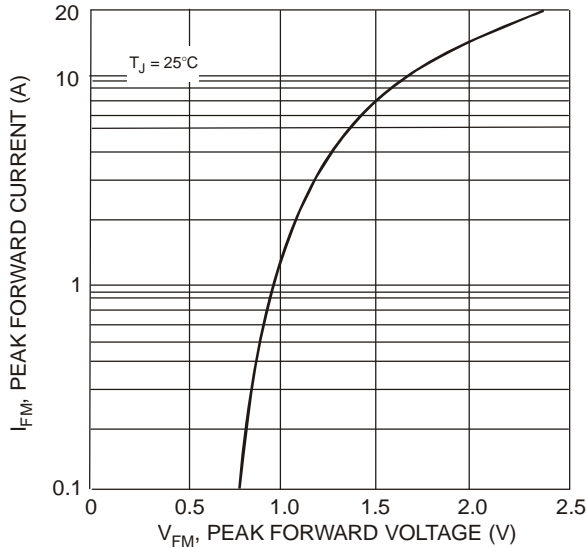

Fig. 3 Peak Forward Current vs. Peak Forward Voltage

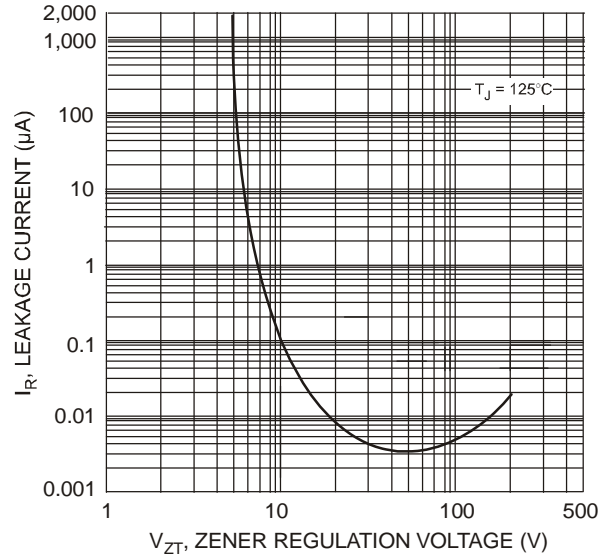

Fig. 4 Leakage Current vs. Regulation Voltage

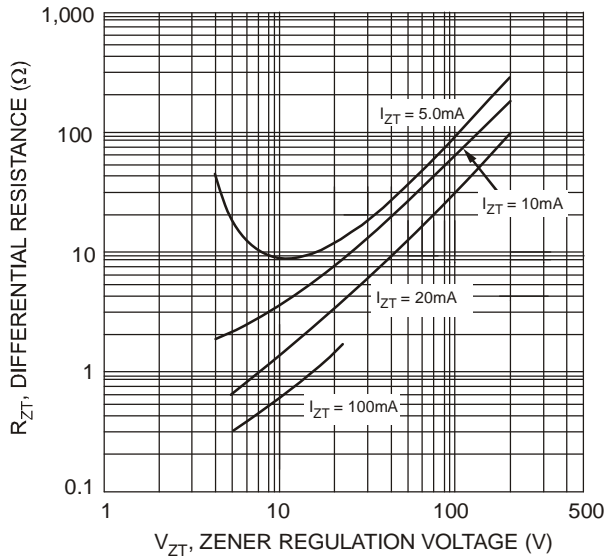

Fig. 5 Differential Resistance vs. Regulation Voltage

**Ordering Information** (Note 5)

Device*	Packaging	Shipping
SMAZx-13-F	SMA	5000/Tape & Reel

\*x = Device Voltage, e.g., SMAZ5V1-13-F.

Notes: 5. For packaging details, go to our website at <http://www.diodes.com/datasheets/ap02007.pdf>.

**Marking Information**

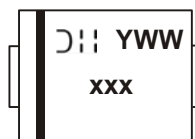

xxx = Product type marking code  
(See Electric Characteristics Table)  
YWW = Manufacturers' code marking  
YWW = Date code marking  
Y = Last digit of year (ex: 2 for 2002)  
WW = Week code 01 to 52

**Package Outline Dimensions**

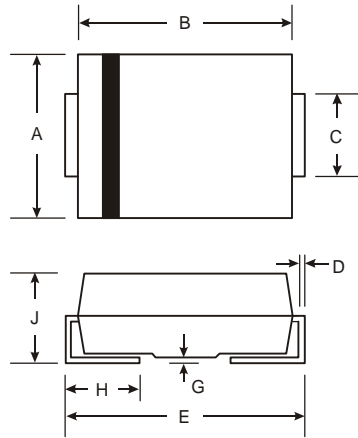

SMA		
Dim	Min	Max
A	2.29	2.92
B	4.00	4.60
C	1.27	1.63
D	0.15	0.31
E	4.80	5.59
G	0.05	0.20
H	0.76	1.52
J	2.01	2.30

All Dimensions in mm

**Suggested Pad Layout**

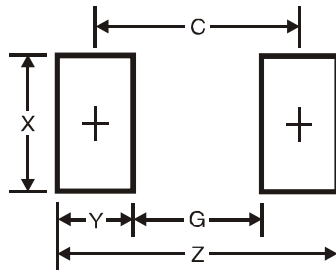

Dimensions	Value (in mm)
Z	6.5
G	1.5
X	1.7
Y	2.5
C	4.0

**IMPORTANT NOTICE**

DIODES INCORPORATED MAKES NO WARRANTY OF ANY KIND, EXPRESS OR IMPLIED, WITH REGARDS TO THIS DOCUMENT, INCLUDING, BUT NOT LIMITED TO, THE IMPLIED WARRANTIES OF MERCHANTABILITY AND FITNESS FOR A PARTICULAR PURPOSE (AND THEIR EQUIVALENTS UNDER THE LAWS OF ANY JURISDICTION).

Diodes Incorporated and its subsidiaries reserve the right to make modifications, enhancements, improvements, corrections or other changes without further notice to this document and any product described herein. Diodes Incorporated does not assume any liability arising out of the application or use of this document or any product described herein; neither does Diodes Incorporated convey any license under its patent or trademark rights, nor the rights of others. Any Customer or user of this document or products described herein in such applications shall assume all risks of such use and will agree to hold Diodes Incorporated and all the companies whose products are represented on Diodes Incorporated website, harmless against all damages.

Diodes Incorporated does not warrant or accept any liability whatsoever in respect of any products purchased through unauthorized sales channel. Should Customers purchase or use Diodes Incorporated products for any unintended or unauthorized application, Customers shall indemnify and hold Diodes Incorporated and its representatives harmless against all claims, damages, expenses, and attorney fees arising out of, directly or indirectly, any claim of personal injury or death associated with such unintended or unauthorized application.

Products described herein may be covered by one or more United States, international or foreign patents pending. Product names and markings noted herein may also be covered by one or more United States, international or foreign trademarks.

**LIFE SUPPORT**

Diodes Incorporated products are specifically not authorized for use as critical components in life support devices or systems without the express written approval of the Chief Executive Officer of Diodes Incorporated. As used herein:

A. Life support devices or systems are devices or systems which:

1. are intended to implant into the body, or
2. support or sustain life and whose failure to perform when properly used in accordance with instructions for use provided in the labeling can be reasonably expected to result in significant injury to the user.

B. A critical component is any component in a life support device or system whose failure to perform can be reasonably expected to cause the failure of the life support device or to affect its safety or effectiveness.

Customers represent that they have all necessary expertise in the safety and regulatory ramifications of their life support devices or systems, and acknowledge and agree that they are solely responsible for all legal, regulatory and safety-related requirements concerning their products and any use of Diodes Incorporated products in such safety-critical, life support devices or systems, notwithstanding any devices- or systems-related information or support that may be provided by Diodes Incorporated. Further, Customers must fully indemnify Diodes Incorporated and its representatives against any damages arising out of the use of Diodes Incorporated products in such safety-critical, life support devices or systems.

Copyright © 2009, Diodes Incorporated

[www.diodes.com](http://www.diodes.com)