

*ROHS COMPLIANT

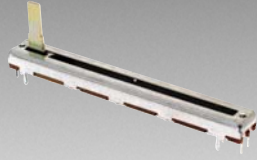

BOURNS®

Features

- Carbon element
- Metal housing
- 15-60 mm travel
- Single and dual gang
- Center detent option
- Dust cover option
- RoHS compliant*



PTA Series - Low Profile Slide Potentiometer

Electrical Characteristics

Taper..... Linear, audio
 Standard Resistance Range
 1 K ohms to 1 M ohms
 Standard Resistance Tolerance..... ±20 %
 Residual Resistance
 500 ohms or 1 % max.
 Insulation Resistance
 Min. 100 megohms at 250 V DC

Environmental Characteristics

Operating Temperature
 -10 °C to +50 °C
 Power Rating, Linear
 15 mm 0.05 W (0.025 W Dual Gang)
 20 mm 0.1 W (0.05 W)
 30 mm 0.2 W (0.1 W)
 45 mm 0.25 W (0.125 W)
 60 mm 0.25 W (0.125 W)
 Power Rating, Audio
 15 mm .. 0.025 W (0.015 W Dual Gang)
 20 mm 0.05 W (0.025 W)
 30 mm 0.1 W (0.05 W)
 45 mm 0.125 W (0.06 W)
 60 mm 0.125 W (0.06 W)
 Maximum Operating Voltage, Linear
 15 mm 100 V DC
 20-60 mm 200 V DC
 Maximum Operating Voltage, Audio
 15 mm 50 V DC
 20-60 mm 150 V DC
 Withstand Voltage, Audio
 1 Min. at 300 V AC
 Sliding Noise 100 mV maximum
 Tracking Error 3 dB at -40 to 0 dB

Mechanical Characteristics

Operating Force 30 to 250 g-cm
 Stop Strength 5 kg-cm min.
 Sliding Life 15,000 cycles
 Soldering Condition
 300 °C max. within 3 seconds
 Travel 15, 20, 30, 45, 60 mm

Derating Curve



Lever Style & Product Dimensions

Actuator Styles

DP METAL LEVER

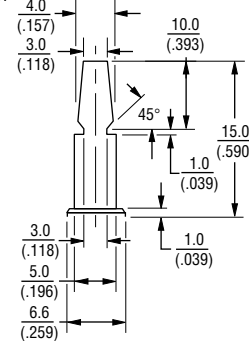

CP METAL LEVER



CI INSULATED LEVER

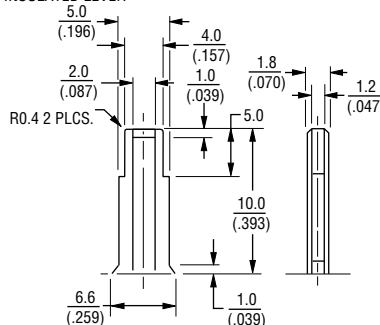

DIMENSIONS: $\frac{\text{MM}}{\text{(INCHES)}}$

How To Order

PTA 15 4 3 - 2 0 10 DP B 203

Model
 Stroke Length
 • 15 = 15 mm
 • 20 = 20 mm
 • 30 = 30 mm
 • 45 = 45 mm
 • 60 = 60 mm
 Dust Cover Option
 • 4 = No Dust Cover
 • 5 = Rubber Dust Cover**
 No. of Gangs
 • 3 = Single Gang
 • 4 = Dual Gang
 Pin Style
 • 2 = PC Pins Down Facing
 Center Detent Option
 • 0 = No Detent
 • 2 = Center Detent
 Standard Lever Length (See Table)
 • 10 = 10 mm (CI Lever)
 • 15 = 15 mm (DP, CP and CI)
 Lever Style
 • DP = Metal Lever (Refer to Drawing)
 • CP = Metal Lever (Refer to Drawing)
 • CI = Insulated Lever (Refer to Drawing)
 Resistance Taper
 • A = Audio Taper
 • B = Linear Taper
 Resistance Code (See Table)

Other styles available.

** Part numbers with dust covers must be mounted with screws to a panel to prevent issues with the dust cover during usage.

Standard Resistance Table

Resistance (Ohms)	Resistance Code
1,000	102
2,000	202
5,000	502
10,000	103
20,000	203
50,000	503
100,000	104
200,000	204
500,000	504
1,000,000	105

Optional Dust Cover

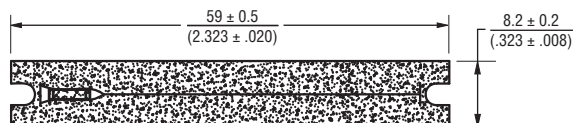

NOTE: DUST COVER HAS ADHESIVE BACK.

$$T = \frac{0.3 \pm 0.1}{(0.118 \pm .004)}$$

*RoHS Directive 2002/95/EC Jan. 27, 2003 including annex and RoHS Recast 2011/65/EU June 8, 2011.

Specifications are subject to change without notice.

The device characteristics and parameters in this data sheet can and do vary in different applications and actual device performance may vary over time.

Users should verify actual device performance in their specific applications.

Applications

- Audio/TV sets
- Car radio
- Amplifiers/mixers/drum machines/synthesizers
- PCs/monitors
- Appliances

PTA Series - Low Profile Slide Potentiometer **BOURNS®**

Product Dimensions

PTAxx43

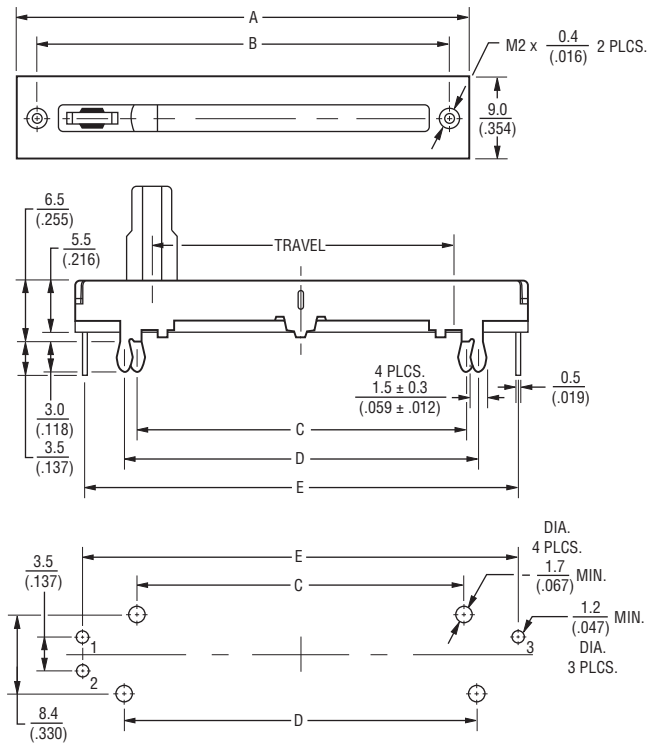

PTAxx44

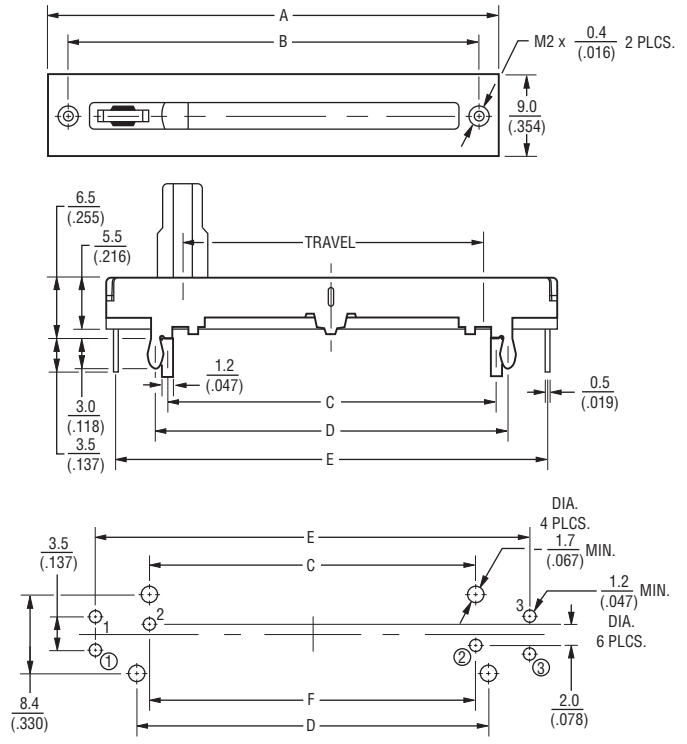

DIMENSIONS: $\frac{\text{MM}}{\text{(INCHES)}}$

Single Gang Dimensions

Model	A	B	C	D	E	Travel
PTA1543	$\frac{30}{(3.18)}$	$\frac{26}{(1.02)}$	$\frac{17.8}{(.700)}$	$\frac{20.2}{(.795)}$	$\frac{28.5}{(1.12)}$	$\frac{15}{(.59)}$
PTA2043	$\frac{35}{(1.37)}$	$\frac{31}{(1.22)}$	$\frac{22.8}{(.897)}$	$\frac{25.2}{(.992)}$	$\frac{33}{(1.29)}$	$\frac{20}{(.787)}$
PTA3043	$\frac{45}{(1.77)}$	$\frac{41}{(1.61)}$	$\frac{32.8}{(1.29)}$	$\frac{35.2}{(1.38)}$	$\frac{43.5}{(1.71)}$	$\frac{30}{(1.18)}$
PTA4543	$\frac{60}{(2.36)}$	$\frac{56}{(2.20)}$	$\frac{47.8}{(1.88)}$	$\frac{50.2}{(1.97)}$	$\frac{58.5}{(2.30)}$	$\frac{45}{(1.77)}$
PTA6043	$\frac{75}{(2.95)}$	$\frac{71}{(2.79)}$	$\frac{62.8}{(2.47)}$	$\frac{65.2}{(2.56)}$	$\frac{73.5}{(2.89)}$	$\frac{60}{(2.36)}$

Dual Gang Dimensions

Model	A	B	C	D	E	F	Travel
PTA1544	$\frac{30}{(3.18)}$	$\frac{26}{(1.02)}$	$\frac{17.8}{(.700)}$	$\frac{20.2}{(.795)}$	$\frac{28.5}{(1.12)}$	$\frac{18}{(.708)}$	$\frac{15}{(.59)}$
PTA2044	$\frac{35}{(1.37)}$	$\frac{31}{(1.22)}$	$\frac{22.8}{(.897)}$	$\frac{25.2}{(.992)}$	$\frac{33}{(1.29)}$	$\frac{23}{(.905)}$	$\frac{20}{(.787)}$
PTA3044	$\frac{45}{(1.77)}$	$\frac{41}{(1.61)}$	$\frac{32.8}{(1.29)}$	$\frac{35.2}{(1.38)}$	$\frac{43.5}{(1.71)}$	$\frac{33}{(1.29)}$	$\frac{30}{(1.18)}$
PTA4544	$\frac{60}{(2.36)}$	$\frac{56}{(2.20)}$	$\frac{47.8}{(1.88)}$	$\frac{50.2}{(1.97)}$	$\frac{58.5}{(2.30)}$	$\frac{48}{(1.88)}$	$\frac{45}{(1.77)}$
PTA6044	$\frac{75}{(2.95)}$	$\frac{71}{(2.79)}$	$\frac{62.8}{(2.47)}$	$\frac{65.2}{(2.56)}$	$\frac{73.5}{(2.89)}$	$\frac{63}{(2.48)}$	$\frac{60}{(2.36)}$

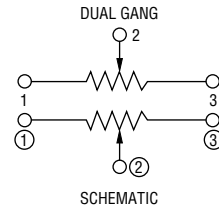

REV. 01/14

Specifications are subject to change without notice. The device characteristics and parameters in this data sheet can and do vary in different applications and actual device performance may vary over time. Users should verify actual device performance in their specific applications.