

SIRIUS SAFETY RELAY BASIC UNIT ADVANCED SERIES RELAY  
 ENABLING CIRCUITS 3 NO CONTACTS + RELAY SIGNALING  
 CIRCUIT 1 NC CONTACT US = 24 V DC SPRING-LOADED  
 TERMINAL



Figure similar

General technical data:	
product brand name	SIRIUS
Product designation	safety relays
Design of the product	For autonomous safety applications
Protection class IP of the enclosure	IP20
Protection against electrical shock	finger-safe
Insulation voltage Rated value	300 V
Ambient temperature	
• during storage	-40 ... +80 °C
• during operation	-25 ... +60 °C
Air pressure acc. to SN 31205	90 ... 106 kPa
Relative humidity during operation	10 ... 95 %
Installation altitude at height above sea level maximum	2 000 m
Vibration resistance acc. to IEC 60068-2-6	5 ... 500 Hz: 0,75 mm
Shock resistance	10g / 11 ms
Surge voltage resistance Rated value	4 000 V
EMC emitted interference	IEC 60947-5-1, Class A

<b>Installation environment regarding EMC</b>	This product is suitable for Class A environments only. It can cause undesired radio-frequency interference in residential environments. If this is the case, the user must take appropriate measures.
<b>Overvoltage category</b>	Installation category III
<b>Degree of pollution</b>	3
<b>Number of sensor inputs 1-channel or 2-channel</b>	1
<b>Design of the cascading</b>	yes
<b>Type of the safety-related wiring of the inputs</b>	single-channel and two-channel
<b>Product property cross-circuit-proof</b>	Yes
<b>Safety Integrity Level (SIL)</b> • acc. to IEC 61508	SIL3
<b>Performance level (PL)</b> • acc. to EN ISO 13849-1	e
<b>Category acc. to EN ISO 13849-1</b>	4
<b>Safe failure fraction (SFF)</b>	99 %
<b>PFHD with high demand rate acc. to EN 62061</b>	0.0000000025 1/h
<b>Average probability of failure on demand (PFDavg) with low demand rate acc. to IEC 61508</b>	0.000007 1/y
<b>T1 value for proof test interval or service life acc. to IEC 61508</b>	20 y
<b>Hardware fault tolerance acc. to IEC 61508</b>	1
<b>Safety device type acc. to IEC 61508-2</b>	Type B
<b>Number of outputs as contact-affected switching element</b> • as NC contact — for signaling function instantaneous contact — for signaling function delayed switching — safety-related instantaneous contact — safety-related delayed switching • as NO contact — for signaling function instantaneous contact — for signaling function delayed switching — safety-related instantaneous contact	1 0 0 0 0 0 0 3
<b>Number of outputs as contact-less semiconductor switching element</b> • safety-related — delayed switching — instantaneous contact • for signaling function instantaneous contact	0 0 0
<b>Stop category acc. to DIN EN 60204-1</b>	0

General technical data:

<b>Design of input</b>	
<ul style="list-style-type: none"> <li>• cascading input/functional switching</li> <li>• feedback input</li> <li>• Start input</li> </ul>	<p>Yes</p> <p>Yes</p> <p>Yes</p>
<b>Type of electrical connection Plug-in socket</b>	No
<b>Operating frequency maximum</b>	360 1/h
<b>Switching capacity current</b>	
<ul style="list-style-type: none"> <li>• of the NO contacts of the relay outputs <ul style="list-style-type: none"> <li>— at DC-13</li> <li>— at 24 V</li> <li>— at 115 V</li> <li>— at 230 V</li> </ul> </li> <li>— at AC-15 <ul style="list-style-type: none"> <li>— at 115 V</li> <li>— at 230 V</li> </ul> </li> <li>• of the NC contacts of the relay outputs <ul style="list-style-type: none"> <li>— at DC-13</li> <li>— at 24 V</li> <li>— at 115 V</li> <li>— at 230 V</li> </ul> </li> <li>— at AC-15 <ul style="list-style-type: none"> <li>— at 115 V</li> <li>— at 230 V</li> </ul> </li> </ul>	<p>5 A</p> <p>0.2 A</p> <p>0.1 A</p> <p>5 A</p> <p>5 A</p> <p>1 A</p> <p>0.2 A</p> <p>0.1 A</p> <p>1.5 A</p> <p>1.5 A</p>
<b>Thermal current of the switching element with contacts maximum</b>	5 A
<b>Operating current at 17 V minimum</b>	5 mA
<b>Mechanical service life (switching cycles) typical</b>	10 000 000
<b>Design of the fuse link for short-circuit protection of the NO contacts of the relay outputs required</b>	gL/gG: 6A or circuit breaker type A: 3A or circuit breaker type B: 2A or circuit breaker type C: 1A
<b>Design of the fuse link for short circuit protection of the NC contacts of the relay outputs required</b>	Diazed or Neozed fuses, operating class gL/gG: 6 A or MCB type A: 2 A or MCB type B: 2 A or MCB type C: 1 A
<b>Cable length</b>	
<ul style="list-style-type: none"> <li>• with Cu 1.5 mm<sup>2</sup> and 150 nF/km per sensor circuit maximum</li> </ul>	4 000 m
<b>Make time with automatic start</b>	
<ul style="list-style-type: none"> <li>• at DC maximum</li> </ul>	110 ms
<b>Make time with automatic start after power failure</b>	
<ul style="list-style-type: none"> <li>• typical</li> <li>• maximum</li> </ul>	<p>6 500 ms</p> <p>6 500 ms</p>
<b>Make time with monitored start</b>	
<ul style="list-style-type: none"> <li>• maximum</li> </ul>	110 ms

<b>Backslide delay time after opening of the safety circuits typical</b>	40 ms
<b>Backslide delay time in the event of power failure</b>	
• typical	30 ms
• maximum	50 ms
<b>Recovery time after opening of the safety circuits typical</b>	30 ms
<b>Recovery time after power failure typical</b>	6.5 s
<b>Pulse duration</b>	
• of the sensor input minimum	75 ms
• of the ON pushbutton input minimum	0.15 s

#### Control circuit/ Control:

<b>Type of voltage of the control supply voltage</b>	DC
<b>Control supply voltage</b>	
• at DC	
— Rated value	24 V
<b>Operating range factor control supply voltage rated value of the magnet coil</b>	
• at DC	0.8 ... 1.2
<b>Active power loss typical</b>	2 W

#### Installation/ mounting/ dimensions:

<b>mounting position</b>	any
<b>Required spacing for grounded parts at the side</b>	5 mm
<b>Required spacing with side-by-side mounting at the side</b>	0 mm
<b>Mounting type</b>	screw and snap-on mounting
<b>Width</b>	22.5 mm
<b>Height</b>	100 mm
<b>Depth</b>	121.6 mm





#### Connections/ Terminals:

<b>Type of electrical connection</b>	spring-loaded terminals
<b>Type of connectable conductor cross-section</b>	
• solid	1x (0.5 ... 1.5 mm <sup>2</sup> ), 2x (0.5 ... 1.5 mm <sup>2</sup> )
• finely stranded	
— with core end processing	1x (0.5 ... 1.0 mm <sup>2</sup> ), 2x (0.5 ... 1.0 mm <sup>2</sup> )
— without core end processing	1x (0.5 ... 1.5 mm <sup>2</sup> ), 2x (0.5 ... 1.5 mm <sup>2</sup> )
<b>Type of connectable conductor cross-section for AWG conductors</b>	
• solid	1x (20 ... 16), 2x (20 ... 16)
• stranded	1x (20 ... 16), 2x (20 ... 16)

#### Product Function:

<b>Product function parameterizable</b>	Sensor floating / sensor non-floating, monitored start / autostart, 1-channel / 2-channel sensor connection, cross-circuit detection, startup testing, antivalent sensors, 2-hand switches
<b>Suitability for operation Device connector 3ZY12</b>	Yes
<b>Suitability for interaction press control</b>	Yes
<b>Suitability for use</b>	
• safety switch	Yes
• Monitoring of floating sensors	Yes
• Monitoring of non-floating sensors	Yes
• magnetically operated switch monitoring	Yes
• safety-related circuits	Yes

#### Certificates/ approvals:

General Product Approval	EMC	Functional Safety/Safety of Machinery	Declaration of Conformity
 CCC	 C-TICK	<a href="#">Baumusterbescheinigung</a>	 EG-Konf.
 CSA	 UL		

Test Certificates	other
<a href="#">Typprüfbescheinigung/Werkszeugnis</a>	<a href="#">Bestätigungen</a>

#### Further information

##### Information- and Downloadcenter (Catalogs, Brochures,...)

<http://www.siemens.com/industrial-controls/catalogs>

##### Industry Mall (Online ordering system)

<http://www.siemens.com/industrymall>

##### Cax online generator

<http://support.automation.siemens.com/WW/CAXorder/default.aspx?lang=en&mfb=3SK11212AB40>

##### Service&Support (Manuals, Certificates, Characteristics, FAQs,...)

<https://support.industry.siemens.com/cs/ww/en/ps/3SK11212AB40>

##### Image database (product images, 2D dimension drawings, 3D models, device circuit diagrams, EPLAN macros, ...)

[http://www.automation.siemens.com/bilddb/cax\\_de.aspx?mfb=3SK11212AB40&lang=en](http://www.automation.siemens.com/bilddb/cax_de.aspx?mfb=3SK11212AB40&lang=en)

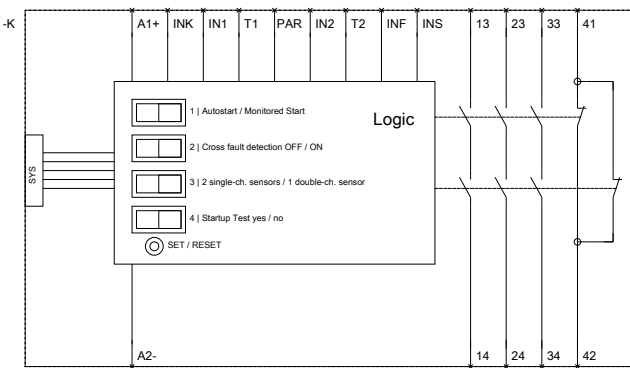
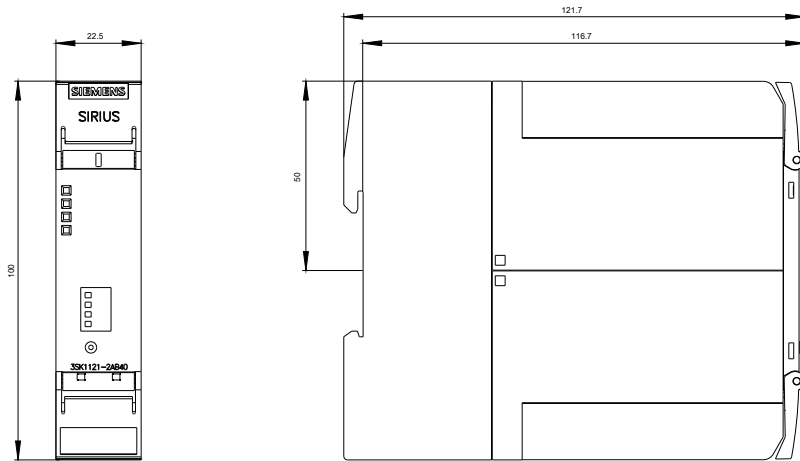

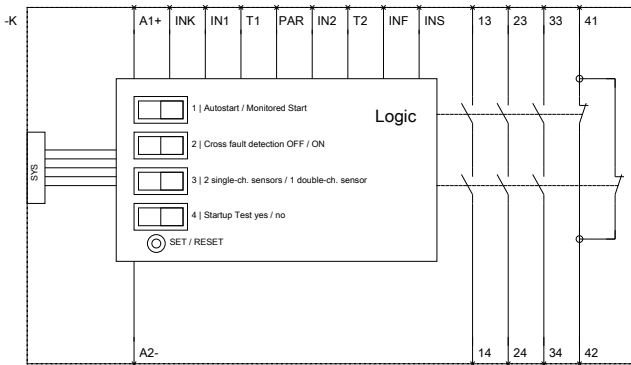

last modified:

20.07.2015