

## contents

### Thermal overload relays



**3RU21** overload relays up to 100 A with screw connection, CLASS 10

#### Selection and ordering data

- Basic Unit 3/10
- Accessories 3/11

Description	3/8 - 3/9
Technical data	3/12 - 3/14
Circuit diagrams	3/15
Dimension drawings	3/16 - 3/17

Page

### Solid state overload relays

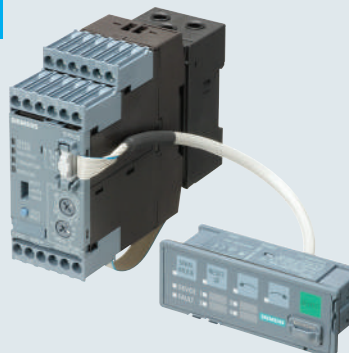

**3RB24** overload relays up to 630A with IO-Link current monitoring

#### Selection and ordering data

- Basic Unit 3/51
- Accessories 3/55

Description	3/52 - 3/53
Technical data	3/58 - 3/62

Page

### SIRIUS 3RV motor starter protectors up to 100 A



**3RB20/21, 3RB30/31** overload relays up to 630 A, **3RB20/30** CLASS 10 or 20 **3RB21/31** CLASS 5, 10, 20, 30

#### Selection and ordering data

- Basic Unit 3/22 - 3/23
- Accessories 3/11

Description	3/18 - 3/19
Cross Reference Aid	3/21
Technical data	3/24 - 3/28
Dimension drawings	3/30
Circuit diagrams	3/31

Page



**3RB22/23** overload relays up to 820 A for full motor protection, CLASS 5 to CLASS 30 adjustable

#### Selection and ordering data

- Basic Unit 3/34 - 3/35
- Accessories 3/49 - 3/50

Description	3/47
Technical data	3/40 - 3/43
Dimension drawings	3/45 - 3/46
Circuit diagrams	3/47

Page



**3UF7 SIMOCODE Pro** Motor management and control devices

#### Selection and ordering data

- Basic Unit 3/73 - 3/75
- Expansion modules 3/76 - 3/78
- Accessories 3/79 - 3/81

Description	3/63 - 3/67
Technical data	3/68 - 3/72
Software and licenses	3/82 - 3/85

Page

Overview



Features

**3RU21**    **3RB30/3RB31**    **3RB20/3RB21**    **3RB22/3RB23**    **3RB24**

Benefits

General data

Sizes	S00 ... S3	S00 ... S3	S6 ... S12	S00 ... S12	S00 ... S12	<ul style="list-style-type: none"> <li>• Are coordinated with the dimensions, connections and technical characteristics of the other devices in the SIRIUS modular system (contactors, etc., ...)</li> <li>• Permit the mounting of slim and compact load feeders in widths of 45 mm (S00), 45 mm (S0), 55 mm (S2), 70 mm (S3), 120 mm (S6) and 145 mm (S10/S12); this does not include the current measuring modules for the 3RB22 to 3RB24 evaluation modules sizes S00 to S3</li> <li>• Simplify configuration</li> </ul>
<b>Seamless current range</b>	0.11 ... 100 A	0.1 ... 100 A	50 ... 630 A	0.3 ... 630 A (up to 820 A) <sup>1)</sup>	0.3 ... 630 A (up to 820 A) <sup>1)</sup>	

Protection functions

<b>Tripping due to overload</b>	✓	✓	✓	✓	✓	<ul style="list-style-type: none"> <li>• Provides optimum inverse-time delayed protection of loads against excessive temperature rises due to overload</li> </ul>
<b>Tripping due to phase unbalance</b>	✓	✓	✓	✓	✓	<ul style="list-style-type: none"> <li>• Provides optimum inverse-time delayed protection of loads against excessive temperature rises due to phase unbalance</li> </ul>
<b>Tripping due to phase failure</b>	✓	✓	✓	✓	✓	<ul style="list-style-type: none"> <li>• Minimizes heating of induction motors during phase failure</li> </ul>
<b>Protection of single-phase loads</b>	✓	—	—	✓	✓	<ul style="list-style-type: none"> <li>• Enables the protection of single-phase loads</li> </ul>
<b>Tripping in the event of overheating</b> by <b>integrated thermistor motor protection function</b>	— <sup>2)</sup>	— <sup>2)</sup>	— <sup>2)</sup>	✓	✓	<ul style="list-style-type: none"> <li>• Provides optimum temperature-dependent protection of loads against excessive temperature rises e.g. for stator-critical motors or in the event of insufficient coolant flow, contamination of the motor surface or for long starting or braking operations</li> <li>• Eliminates the need for additional special equipment</li> <li>• Saves space in the control cabinet</li> <li>• Reduces wiring outlay and costs</li> </ul>
<b>Tripping in the event of a ground fault</b> by <b>internal ground-fault detection (activatable)</b>	—	✓ (only 3RB31)	✓ (only 3RB21)	✓	✓	<ul style="list-style-type: none"> <li>• Provides optimum protection of loads against high-resistance short circuits or ground faults due to moisture, condensed water, damage to the insulation material, etc.</li> <li>• Eliminates the need for additional special equipment</li> <li>• Saves space in the control cabinet</li> <li>• Reduces wiring outlay and costs</li> </ul>

✓ Available  
— Not available

<sup>1)</sup> Motor currents up to 820 A can be recorded and evaluated by a current measuring module, e.g. 3RB29 06-2BG1 (0.3 to 3 A), in combination with 3UF18 68-3GA00 (820 A/1 A) series transformer.

<sup>2)</sup> The SIRIUS 3RN thermistor motor protection devices can be used to provide additional temperature-dependent protection.

General data



Features	3RU21	3RB30/3RB31	3RB20/3RB21	3RB22/3RB23	3RB24	Benefits
<b>Features</b>						
<b>RESET function</b>	✓	✓	✓	✓	✓	<ul style="list-style-type: none"> <li>Allows manual or automatic resetting of the device</li> </ul>
<b>Remote RESET function</b>	✓ (by means of separate module)	✓ (only with 3RB31 and external auxiliary voltage 24 V DC)	✓ (only with 3RB21 and external auxiliary voltage 24 V DC)	✓ (electrically via external button)	✓ (electrically with button or via IO-Link)	<ul style="list-style-type: none"> <li>Allows the remote resetting of the device</li> </ul>
<b>TEST function for auxiliary contacts</b>	✓	✓	✓	✓	✓	<ul style="list-style-type: none"> <li>Allows easy checking of the function and wiring</li> </ul>
<b>TEST function for electronics</b>	—	✓	✓	✓	✓	<ul style="list-style-type: none"> <li>Allows checking of the electronics</li> </ul>
<b>Status display</b>	✓	✓	✓	✓	✓	<ul style="list-style-type: none"> <li>Displays the current operating state</li> </ul>
<b>Large current adjustment button</b>	✓	✓	✓	✓	✓	<ul style="list-style-type: none"> <li>Makes it easier to set the relay exactly to the correct current value</li> </ul>
<b>Integrated auxiliary contacts (1 NO + 1 NC)</b>	✓	✓	✓	✓ (2 ×)	—	<ul style="list-style-type: none"> <li>Allows the load to be switched off if necessary</li> <li>Can be used to output signals</li> </ul>
<b>Integrated auxiliary contacts (1 CO and 1 NO in series)</b>	—	—	—	—	✓	<ul style="list-style-type: none"> <li>Enables the controlling of contactors directly from the higher-level control system through IO-Link</li> </ul>
<b>IO-Link connection</b>	—	—	—	—	✓	<ul style="list-style-type: none"> <li>Reduction of wiring in the control cabinet</li> <li>Enables communication</li> </ul>
<b>Connection of optional handheld device</b>	—	—	—	—	✓	<ul style="list-style-type: none"> <li>Enables local operation</li> </ul>
<b>Communication capability through IO-Link</b>						
<b>Full starter functionality through IO-Link</b>	—	—	—	—	✓	<ul style="list-style-type: none"> <li>Enables in combination with the SIRIUS 3RT contactors the assembly of communication-capable motor starters (direct-on-line, reversing and wye-delta starting)</li> </ul>
<b>Reading out of diagnostics functions</b>	—	—	—	—	✓	<ul style="list-style-type: none"> <li>Enables the reading out of diagnostics information such as overload, open circuit, ground fault, etc.</li> </ul>
<b>Reading out of current values</b>	—	—	—	—	✓	<ul style="list-style-type: none"> <li>Enables the reading out of current values and their direct processing in the higher-level control system</li> </ul>
<b>Reading out all set parameters</b>	—	—	—	—	✓	<ul style="list-style-type: none"> <li>Enables the reading out of all set parameters, e.g. for plant documentation</li> </ul>

✓ Available  
 — Not available

General data



Features

3RU21    3RB30/3RB31    3RB20/3RB21    3RB22/3RB23    3RB24

Benefits

**Design of load feeders**

Features	3RU21	3RB30/3RB31	3RB20/3RB21	3RB22/3RB23	3RB24	Benefits
<b>Short-circuit strength up to 100 kA at 690 V</b> (in conjunction with the corresponding fuses or the corresponding motor starter protector)	✓	✓	✓	✓	✓	<ul style="list-style-type: none"> <li>Provides optimum protection of the loads and operating personnel in the event of short circuits due to insulation faults or faulty switching operations</li> </ul>
<b>Electrical and mechanical matching to 3RT contactors</b>	✓	✓	✓	✓ <sup>1)</sup>	✓ <sup>1)</sup>	<ul style="list-style-type: none"> <li>Simplifies configuration</li> <li>Reduces wiring outlay and costs</li> <li>Enables stand-alone installation as well as space-saving direct mounting</li> </ul>
<b>Straight-through transformers for main circuit<sup>2)</sup></b> (in this case the cables are routed through the feed-through openings of the overload relay and connected directly to the box terminals of the contactor)	—	✓ (S2, S3)	✓ (S3 to S6)	✓ (S00 ... S6)	✓ (S00 ... S6)	<ul style="list-style-type: none"> <li>Reduces the contact resistance (only one point of contact)</li> <li>Saves wiring costs (easy, no need for tools, and fast)</li> <li>Saves material costs</li> <li>Reduces installation costs</li> </ul>
<b>Spring-type connection system for main circuit<sup>2)</sup></b>	✓ (S00, S0)	✓ (S00, S0)	—	—	—	<ul style="list-style-type: none"> <li>Enables fast connections</li> <li>Permits vibration-resistant connections</li> <li>Enables maintenance-free connections</li> </ul>
<b>Spring-type connection system for auxiliary circuits<sup>2)</sup></b>	✓	✓	✓	✓	✓	<ul style="list-style-type: none"> <li>Enables fast connections</li> <li>Permits vibration-resistant connections</li> <li>Enables maintenance-free connections</li> </ul>
<b>Ring terminal lug connection method for main and auxiliary circuits<sup>2)</sup></b>	✓ (S00, S0)	—	—	—	—	<ul style="list-style-type: none"> <li>Enables fast connections</li> <li>Permits vibration-resistant connections</li> <li>Enables maintenance-free connections</li> </ul>
<b>Full starter functionality through IO-Link</b>	—	—	—	—	✓	<ul style="list-style-type: none"> <li>Enables in combination with the SIRIUS 3RT contactors the assembly of communication-capable motor starters (direct-on-line, reversing and wye-delta starting)</li> </ul>
<b>Starter function</b>	—	—	—	—	✓	<ul style="list-style-type: none"> <li>Integration of feeders via IO-Link in the control system up to 630 A or 820 A</li> </ul>

✓ Available  
— Not available

<sup>1)</sup> Exception: up to size S3, only stand-alone installation is possible.  
<sup>2)</sup> Alternatively available for screw terminals.

General data



Features	3RU21	3RB30/3RB31	3RB20/3RB21	3RB22/3RB23	3RB24	Benefits
<b>Other features</b>						
<b>Temperature compensation</b>	✓	✓	✓	✓	✓	<ul style="list-style-type: none"> <li>Allows the use of the relays at high temperatures without derating</li> <li>Prevents premature tripping</li> <li>Allows compact installation of the control cabinet without distance between the devices/load feeders</li> </ul>
<b>Very high long-term stability</b>	✓	✓	✓	✓	✓	<ul style="list-style-type: none"> <li>Provides safe protection for the loads even after years of use in severe operating conditions</li> </ul>
<b>Wide setting ranges</b>	—	✓ (1:4)	✓ (1:4)	✓ (1:10)	✓ (1:10)	<ul style="list-style-type: none"> <li>Minimize the configuration outlay and costs</li> <li>Minimize storage overheads, storage costs, tied-up capital</li> </ul>
<b>Fixed trip class</b>	CLASS 10 CLASS 10A	3RB30: CLASS 10E or CLASS 20E	3RB20: CLASS 10 or CLASS 20			<ul style="list-style-type: none"> <li>Optimum motor protection for standard starts</li> </ul>
<b>Trip classes adjustable on the device CLASS 5, 10, 20, 30</b>	—	3RB31: ✓	3RB21: ✓	✓	✓	<ul style="list-style-type: none"> <li>Enables solutions for very fast starting motors requiring special protection (e.g. Ex motors)</li> <li>Enables heavy starting solutions</li> <li>Reduces the number of versions</li> </ul>
<b>Low power loss</b>	—	✓	✓	✓	✓	<ul style="list-style-type: none"> <li>Reduces energy consumption and energy costs (up 98 % less energy is used than for thermal overload relays).</li> <li>Minimizes temperature rises of the contactor and control cabinet – in some cases this may eliminate the need for control-gear cabinet cooling.</li> <li>Direct mounting to contactor saves space, even for high motor currents (i.e. no heat decoupling is required).</li> </ul>
<b>Internal power supply</b>	— <sup>1)</sup>	✓	✓	—	—	<ul style="list-style-type: none"> <li>Eliminates the need for configuration and connecting an additional control circuit</li> </ul>
<b>Supplied from an external voltage through IO-Link</b>	—	—	—	—	✓	<ul style="list-style-type: none"> <li>Eliminates the need for configuration and connecting an additional control circuit</li> </ul>
<b>Overload warning</b>	—	—	—	✓	✓	<ul style="list-style-type: none"> <li>Indicates imminent tripping of the relay directly on the device due to overload, phase unbalance or phase failure through flickering of the LEDs or in the case of the 3RB24 as a signal through IO-Link</li> <li>Allows the imminent tripping of the relay to be signaled</li> <li>Allows measures to be taken in time in the event of inverse-time delayed overloading of the load for an extended period over the current limit</li> </ul>
<b>Analog output</b>	—	—	—	✓	✓	<ul style="list-style-type: none"> <li>Allows the output of an analog output signal for actuating moving-coil instruments, feeding programmable logic controllers or transfer to bus systems</li> <li>Eliminates the need for an additional measuring transducer and signal converter</li> </ul>

✓ Available  
— Not available

<sup>1)</sup> SIRIUS 3RU21 thermal overload relays use a bimetal contactor and therefore do not require a control supply voltage.

General data

Overview of overload relays – matching contactors

Overload relays	Current measurement	Current range	Contactors (type, size, rating in HP)							
			3RT20 1.	3RT20 2.	3RT20 3.	3RT20 4.	3RT20 5.	3RT20 6.	3RT20 7	3TF68/ 3TF69
		A	S00	S0	S2	S3	S6	S10	S12	Size 14
Type	Type	A	3/5/7.5/10	5/7.5/10/15/20/25	30/40/50	50/60/70	100/125/150	150/200/250	300/400	500/700

**SIRIUS 3RU21 thermal overload relays**



3RU21

3RU21 1	Integrated	0.11 ... 16	✓	—	—	—	—	—	—	—
3RU21 2	Integrated	1.8 ... 40	—	✓	—	—	—	—	—	—
3RU21 3	Integrated	22 ... 80	—	—	✓	—	—	—	—	—
3RU21 4	Integrated	28 ... 100	—	—	—	✓	—	—	—	—

**SIRIUS 3RB30 solid-state overload relays<sup>1)</sup>**



3RB30

3RB30 1	Integrated	0.1 ... 16	✓	—	—	—	—	—	—	—
3RB30 2	Integrated	0.1 ... 40	—	✓	—	—	—	—	—	—
3RB30 3	Integrated	12 ... 80	—	—	✓	—	—	—	—	—
3RB30 4	Integrated	32 ... 115	—	—	—	✓	—	—	—	—

**SIRIUS 3RB31 solid-state overload relays<sup>1)</sup>**



3RB31

3RB31 1	Integrated	0.1 ... 16	✓	—	—	—	—	—	—	—
3RB31 2	Integrated	0.1 ... 40	—	✓	—	—	—	—	—	—
3RB31 3	Integrated	12 ... 80	—	—	✓	—	—	—	—	—
3RB31 4	Integrated	32 ... 115	—	—	—	✓	—	—	—	—

**SIRIUS 3RB20 solid-state overload relays<sup>1)</sup>**



3RB20

3RB20 5	Integrated	50 ... 200	—	—	—	—	✓	—	—	—
3RB20 6	Integrated	55 ... 630	—	—	—	—	—	✓	✓	✓
3RB20 1 + 3UF18	Integrated	630 ... 820	—	—	—	—	—	—	—	✓

**SIRIUS 3RB21 solid-state overload relays<sup>1)</sup>**



3RB21

3RB21 5	Integrated	50 ... 200	—	—	—	—	✓	—	—	—
3RB21 6	Integrated	55 ... 630	—	—	—	—	—	✓	✓	✓
3RB21 1 + 3UF18	Integrated	630 ... 820	—	—	—	—	—	—	—	✓

✓ Can be used  
— Cannot be used

<sup>1)</sup> "Technical Specifications" for use of the overload relays with trip class ≥ CLASS 20 can be found in "Short-circuit protection with fuses for motor feeders".

General data

Overview of overload relays – matching contactors (continued)

Overload relays	Current measurement	Current range	Contactors (type, size, rating in HP)							
			3RT20 1	3RT20 2	3RT20 3	3RT20 4	3RT20 5	3RT20 6	3RT20 7	3TF68/ 3TF69
Type	Type	A	S00	S0	S2	S3	S6	S10	S12	Size 14
			3/5/7.5/1.	5/7.5/10/15/ 20/25	30/40/50	50/60/75	100/125/150	150/200/250	300/400	500/700

SIRIUS 3RB22 to 3RB24 solid-state overload relays<sup>1)</sup>



3RB22, 3RB23



3RB24

Overload relays	Current range	3RT20 1	3RT20 2	3RT20 3	3RT20 4	3RT20 5	3RT20 6	3RT20 7	3TF68/ 3TF69
3RB22 83/ 3RB23 83/ 3RB24 83+	3RB29 0	0.3 ... 25	✓	✓	—	—	—	—	—
	3RB29 0	10 ... 100	✓	✓	✓	✓	—	—	—
	3RB29 5	20 ... 200	—	✓	✓	✓	✓	—	—
	3RB29 6	63 ... 630	—	—	—	—	—	✓	✓
	3RB29 0 + 3UF18	630 ... 820	—	—	—	—	—	—	—

✓ Can be used  
— Cannot be used

<sup>1)</sup> "Technical Specifications" for use of the overload relays with trip class ≥ CLASS 20 can be found in "Short-circuit protection with fuses for motor feeders",

Connection methods

Depending on the device version of the 3RU2 and 3RB3 overload relays, the terminals for screw terminals, spring-type terminals or ring terminal lug connection are configured for both the main and auxiliary circuit in frame sizes S00 and S0.

The 3RU21 thermal overload relays come with screw terminals.

The electronic overload relays 3RB20 and 3RB21 are available with screw terminals (box terminals) or spring-type terminals on the auxiliary current side; the same applies for the evaluation modules of the 3RB22 to 3RB24 electronic overload relays for High-Feature applications.



# Thermal Overload Relays

3RU21 up to 100 A, CLASS 10

**Description**

The 3RU thermal overload relays up to 100 A are designed for current-dependent protection of applications with normal start-up conditions (see "Trip classes") against impermissibly high rises in temperature as a result of overload or phase failure (see "Phase failure protection"). An overload or phase failure causes the motor current to rise above the set rated motor current (see "Setting"). This current rise heats up the bimetal strips within the relay via heating elements which, in turn, operate the auxiliary contacts via a tripping mechanism due to their deflection (see "Auxiliary contacts"). These switch the load off via a contactor. The switch-off time is dependent on the ratio of tripping current to operational current  $I_e$  and is stored in the form of a tripping characteristic with long-term stability (see "Tripping characteristics"). The "Tripped" state is signalled by means of a switching position indicator (see "Indication of status").

Resetting takes place manually or automatically (see "Manual and automatic resetting") after a recovery time has elapsed (see "Recovery time").

The 3RU thermal overload relays are electrically and mechanically optimised to the 3RT contactors such that, in addition to individual mounting, they can also be directly mounted onto the contactors to save space (see "Design and mounting"). The main and auxiliary circuits can be connected in various ways (see "Connection"), including the use of Cage Clamp terminals. When the overload relay has been connected, it can be tested for correct functioning using a TEST slide (see "TEST function"). In addition to the TEST function, the 3RU thermal overload relay is equipped with a STOP function (see "STOP function").

For a wide variety of application possibilities for the 3RU thermal overload relay, please refer to the sections "Application", "Ambient conditions", "Overload relays in WYE-delta combinations" and "Operation with frequency converters".

The 3RU thermal overload relays can protect your loads from overload and phase failure. You must implement short-circuit protection (see "Short-circuit protection") by means of a fuse or circuit-breaker.

The 3RU thermal overload relays are environmentally friendly

(see "Environmental considerations") and comply with all the main international standards and approvals (see "Specifications" and "Increased safety type of protection EEx").

The accessories for the 3RU thermal overload relays have been designed on the principle that all requirements are covered by a small number of variants.

**Application**

The 3RU thermal overload relays are designed for the protection of three-phase and single-phase AC and DC motors.

If single-phase AC or DC loads are to be protected using 3RU thermal overload relays, all three bimetal strips should be heated. Therefore all main circuits of the relay must be connected in series.

**Overload relays in WYE-delta combinations**

When overload relays are used in WYE-delta combinations, it is important to note that only 1/√3 of the motor current flows through the mains contactor. An overload relay mounted on the main contactor must be set to 0.58 times the motor current.

A second overload relay must be mounted on the star contactor if your load is also to be optimally protected in WYE operation. The WYE current is 1/3 of the rated motor current. The relevant relay must be set to this current.

**Control circuit**

An additional power supply is not required for operation of the 3RU thermal overload relays.

**Ambient conditions**

The 3RU thermal overload relays are temperature compensating according to IEC 60 947-4-1/DIN VDE 0660 Part 102 in the temperature range -20 °C to +60 °C. For temperatures from +60 °C to +80 °C, the upper setting value of the setting range must be reduced by a specific factor as given in the table below.

Ambient temperature in °C	Reduction factor for the upper setting value
+60	1.0
+65	0.94
+70	0.87
+75	0.81
+80	0.73

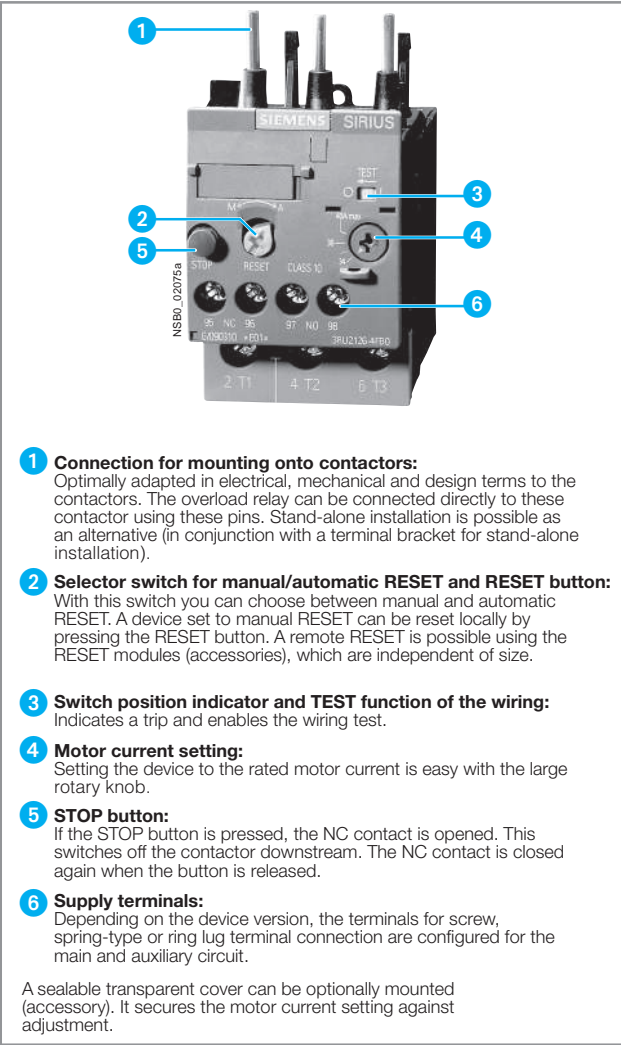

- 1 Connection for mounting onto contactors:**  
Optimally adapted in electrical, mechanical and design terms to the contactors. The overload relay can be connected directly to these contactor using these pins. Stand-alone installation is possible as an alternative (in conjunction with a terminal bracket for stand-alone installation).
  - 2 Selector switch for manual/automatic RESET and RESET button:**  
With this switch you can choose between manual and automatic RESET. A device set to manual RESET can be reset locally by pressing the RESET button. A remote RESET is possible using the RESET modules (accessories), which are independent of size.
  - 3 Switch position indicator and TEST function of the wiring:**  
Indicates a trip and enables the wiring test.
  - 4 Motor current setting:**  
Setting the device to the rated motor current is easy with the large rotary knob.
  - 5 STOP button:**  
If the STOP button is pressed, the NC contact is opened. This switches off the contactor downstream. The NC contact is closed again when the button is released.
  - 6 Supply terminals:**  
Depending on the device version, the terminals for screw, spring-type or ring lug terminal connection are configured for the main and auxiliary circuit.
- A sealable transparent cover can be optionally mounted (accessory). It secures the motor current setting against adjustment.

3RU21 26-4FB00 thermal overload relays

**Trip classes**

The 3RU thermal overload relay is available for normal start-up conditions in CLASS 10. For further details about trip classes, see "Tripping characteristics".

**Tripping characteristics**

The tripping characteristics show the relationship between the tripping time and the tripping current as a multiple of the operational current  $I_e$  and are specified for symmetrical three-pole and two-pole loading from cold.

The smallest current at which tripping occurs is called the limiting tripping current. In accordance with IEC 60 947-4-1/ DIN VDE 0660 Part 102, this must lie within certain specified limits. The limits of the limiting tripping current lie, in the case of the 3RU11 thermal overload re-

lay for symmetrical three-pole loading between 105 % and 120 % of the operational current. Starting from the limiting tripping current, the tripping characteristic moves on to larger tripping currents based on the characteristics of the so-called trip classes (CLASS 10, CLASS 20 etc.). The trip classes describe time-intervals within which the overload relay must trip with 7.2 times the operational current  $I_e$  for symmetrical three-pole loading from cold.

The tripping times are:

CLASS	Tripping times
10A	2 s to 10 s
10	4 s to 10 s
20	6 s to 20 s
30	9 s to 30 s





## Thermal Overload Relays

3RU21 up to 100 A, CLASS 10

## Description

This is the schematic representation of a characteristic. The characteristics of the individual 3RU thermal overload relays can be requested from Technical Assistance at the e-mail address: [nst.technical-assistance@siemens.de](mailto:nst.technical-assistance@siemens.de)

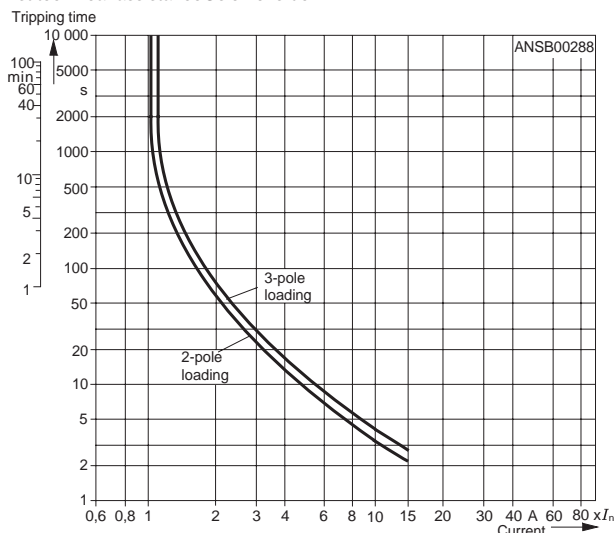

The tripping characteristic of a three-pole 3RU thermal overload relay (see characteristic for symmetrical three-pole loading from cold) is valid when all three bimetal strips are loaded with the same current simultaneously. If, however, only two bimetal strips are heated as a result of phase failure, these two strips would have to provide the force necessary for operating the release mechanism and, if no additional measures were implemented, they would require a longer tripping time or a higher current. These increased current levels over long periods usually result in damage to the consumer. To prevent damage, the 3RU thermal overload relay features phase failure sensitivity which, thanks to an appropriate mechanical mechanism, results in accelerated tripping according to the characteristic for two-pole loading from cold.

In contrast to a load in the cold state, a load at operating temperature has a lower heat reserve. This fact affects the 3RU thermal overload relay in that following an extended period of loading at operational current  $I_n$ , the tripping time reduces by about a quarter.

## Phase failure protection

The 3RU thermal overload relays feature phase failure protection (see "Tripping characteristics") for the purpose of minimizing the heating of the load during single-phase operation as a result of phase failure.

## Setting

The 3RU thermal overload relay is adjusted to the rated motor current using a rotary knob. The scale of the rotary knob is calibrated in Amperes.

## Manual and automatic resetting

It is possible to switch between manual resetting and automatic resetting by depressing and rotating the blue button (RESET button). When manual resetting is selected, a reset can be performed directly on the device by pressing the RESET button. Remote resetting can be implemented by using the mechanical and electrical RESET modules from the range of accessories (see "Accessories"). When the blue button is set to Automatic RESET, the relay will be reset automatically.

A reset is not possible until the recovery time has elapsed (see "Recovery time").

## Recovery time

After tripping due to an overload, it takes a certain length of time for the bimetal strips of the 3RU thermal overload relays to cool down. The relay can only be reset once it has cooled down. This time (recovery time) is dependent on the tripping characteristic and the level of the tripping current.

After tripping due to overload, the recovery time allows the load to cool down.

## TEST function

Correct functioning of the ready 3RU thermal overload relay can be tested with the TEST slide. The slide is operated to simulate tripping of the relay. During this simulation, the NC contact (95-96) is opened and the NO contact (97-98) is closed whereby the overload relay checks that the auxiliary circuit is wired correctly. When the 3RU thermal overload relay is set to Automatic RESET, an automatic reset takes place when the TEST slide is released. The relay must be reset using the RESET button when it is set to Manual RESET.

## STOP function

When the STOP button is pressed, the NC contact is opened and the series-connected contactor and therefore the load is switched Off. The load is reconnected via the contactor when the STOP button is released.

## Status indication

The current status of the 3RU thermal overload relay is indicated by the position of the marking on the "TEST function/switching position indicator" slide. The marking on the slide is on the left at the "O" mark following a trip due to overload or phase failure and at the "I" mark otherwise.

## Auxiliary contacts

The 3RU thermal overload relay is equipped with an NO contact for the tripped signal and an NC contact for switching off the contactor.

## Connection

All the 3RU thermal overload relays have screw terminals for the main and auxiliary circuits. Once the box terminals have been removed from the main conductor connections of the overload relays of size S3, it is possible to connect busbars.

Alternatively the devices are available with either spring loaded or with ring lug terminals on both the control and the main terminals. For details of various connection possibilities, see the "Technical data" and "Selection and ordering data".

## Design and mounting

The 3RU thermal overload relays are suitable for direct mounting on the 3RT contactors. They can also be mounted as single units if the appropriate adapters are used. For details of the mounting possibilities, see the "Selection and ordering data" and the "Technical data".

## Operation with frequency converters

The 3RU thermal overload relays are suitable for operation with frequency converters. Depending on the frequency of the converter, a current higher than the motor current may have to be set due to the occurrence of eddy currents and skin effects.

## Environmental considerations

The devices are manufactured taking environmental considerations into account and comprise environmentally-friendly and recyclable materials.

## Specifications

The 3RU thermal overload relays comply with the requirements of:

- IEC 60 947-1/  
DIN VDE 0660 Part 100
- IEC 60 947-4-1/  
DIN VDE 0660 Part 102
- IEC 60 947-5-1/  
DIN VDE 0660 Part 200
- IEC 60801-2, -3, -4, -5 and
- UL 508/CSA C 22.2.

The 3RU11 thermal overload relays are also safe from touch according to DIN VDE 0106 Part 100 and climate-proof to IEC 721.

## Degree of protection "Increased safety" EEx

The 3RU thermal overload relay meets the requirements for overload protection of motors of the "Increased safety" type of protection EEx e IEC 50 019/  
DIN VDE 0165, DIN VDE 0170, DIN VDE 171.  
KEMA test certificate number Ex-97.Y.3235,  
DMT 98 ATEX G001,  
EN 50 019: 1977 + A1 ... A5,  
Increased Safety "e". Appendix A, Guideline for temperature monitoring of squirrel cage motors during operation.

## Accessories

For the 3RU thermal overload relay, there are:

- one adapter for each of the four overload relay sizes S00 to S3 for individual mounting
- one electrical remote RESET module for all sizes in three different voltage variants
- one mechanical remote RESET module for all sizes
- one cable release for all sizes for resetting inaccessible devices
- terminal covers

The accessories can also be used for the 3RB solid state overload relay.

# Thermal Overload Relays

3RU21 up to 100 A, CLASS 10

### Selection and ordering data

#### Features and technical characteristics

- Auxiliary contacts: 1 NO + 1 NC
- Manual/automatic RESET
- Switching position indication
- CLASS 10
- TEST function
- STOP button
- Phase failure sensitivity
- Sealable cover: optional in S00, S0 & S2. Integrated in S3

### Ordering information

- Replace the (••) with the letter Number combination from the Terminal types I table
- Replace the (††) with the letter Number combination from the Terminal types II table
- For description, [see page 3/8](#)
- For technical data, [see pages 3/12-3/15](#)
- For circuit diagrams, [see page 3/15](#)
- For dimension drawings, [see page 3/16-3/17](#).

•• Terminal Types I			†† Terminal Types II		
Type	Mounting Type	Ltr	Type	Mounting Type	Ltr
Screw	Direct to Contactor	B0	Screw	Direct to Contactor	B0
Screw <sup>1)</sup>	Stand Alone	B1	Screw <sup>4)</sup>	Stand Alone	B1
Spring <sup>2)</sup>	Direct to Contactor	C0	Spring <sup>3)</sup>	Direct to Contactor	D0
Spring <sup>1)2)</sup>	Stand Alone	C1	Spring <sup>3)4)</sup>	Stand Alone	D1
Ring Lug	Direct to Contactor	J0			



3RU2116-1GB0



3RU2116-1GC0



3RU2126-4NB0



3RU2136-4RB1



3RU2146-4JB0

### Thermal Overload Relays up to 40A Frame Size S00 and S0 ••

Setting Range	Order No.	Setting Range	Order No.	Weight approx. (screw/spring) kg
A		A		
<b>Frame Size S00: For mounting directly to 3RT201 contactors or for stand-alone installation</b>				
0.11 - 0.16	3RU2116-0A••	1.4 - 2	3RU2116-1B••	0.13/0.15
0.14 - 0.2	3RU2116-0B••	1.8 - 2.5	3RU2116-1C••	
0.18 - 0.25	3RU2116-0C••	2.2 - 3.2	3RU2116-1D••	
0.22 - 0.32	3RU2116-0D••	2.8 - 4	3RU2116-1E••	
0.28 - 0.4	3RU2116-0E••	3.5 - 5	3RU2116-1F••	
0.35 - 0.5	3RU2116-0F••	4.5 - 6.3	3RU2116-1G••	0.13/0.15
0.45 - 0.63	3RU2116-0G••	5.5 - 8	3RU2116-1H••	
0.55 - 0.8	3RU2116-0H••	7 - 10	3RU2116-1J••	
0.7 - 1	3RU2116-0J••	9 - 12.5	3RU2116-1K••	
0.9 - 1.25	3RU2116-0K••	11 - 16	3RU2116-4A••	
1.1 - 1.6	3RU2116-1A••			0.13/0.15
<b>Frame Size S0: For mounting directly to 3RT202 contactors or for stand-alone installation</b>				
1.8 - 2.5	3RU2126-1C••	11 - 16	3RU2126-4A••	0.16/0.22
2.2 - 3.2	3RU2126-1D••	14 - 20	3RU2126-4B••	
2.8 - 4	3RU2126-1E••	17 - 22	3RU2126-4C••	
3.5 - 5	3RU2126-1F••	20 - 25	3RU2126-4D••	
4.5 - 6.3	3RU2126-1G••	23 - 28	3RU2126-4N••	
5.5 - 8	3RU2126-1H••	27 - 32	3RU2126-4E••	0.16/0.22
7 - 10	3RU2126-1J••	30 - 36	3RU2126-4P••	
9 - 12.5	3RU2126-1K••	34 - 40	3RU2126-4F••	

### Thermal Overload Relays up to 100A Frame Size S2 and S3 ††

Setting Range	Order No.	Setting Range	Order No.	Weight approx. (screw/spring) kg
A		A		
<b>Frame Size S2: For mounting directly to 3RT203 contactors<sup>4)</sup></b>				
22 - 32	3RU2136-4E††	47 - 57	3RU2136-4Q††	0.34
28 - 40	3RU2136-4F††	54 - 65	3RU2136-4J††	
36 - 45	3RU2136-4G††	62 - 73	3RU2136-4K††	
40 - 50	3RU2136-4H††	70 - 80	3RU2136-4R††	
<b>Frame Size S3: For mounting directly to 3RT104 contactors<sup>4)</sup></b>				
28 - 40	3RU2146-4F††	57 - 75	3RU2146-4K††	
36 - 50	3RU2146-4H††	70 - 90	3RU2146-4L††	
45 - 63	3RU2146-4J††	80 - 100 <sup>5)</sup>	3RU2146-4M††	

- 1) Not available for size S0 3RU212 with current setting range below 14 A.
- 2) Size S00 and S0: main and auxiliary conductor terminals are spring-type.
- 3) Size S2 and S3 auxiliary terminals are spring-type only. Main conductor terminals are screw.
- 4) 3RU Overloads in S2 and S3 frame are available preassembled with a terminal bracket for standalone mounting. S2 and S3 overloads can also be customer assembled to the terminal bracket (see Accessories).
- 5) For overload relays > 100A, see electronic overload relays.

**Accessories**

Design	for type		Order No.	Weight approx kg	
	Size				
<b>Terminal brackets for stand-alone installation <sup>1)</sup></b>					
 3RU29 36-3AA01	For separate mounting of the overload relay; panel mount or snapped onto 35 mm standard mounting rail, size S3 also for 75 mm standard mounting rail	<i>Screw terminals</i>	S00	3RU29 16-3AA01 3RU29 26-3AA01 3RU29 36-3AA01 3RU29 46-3AA01	0.04
			S0		0.05
			S2		0.18
			S3		0.28
		<i>Spring Loaded terminals</i>	S00	3RU29 16-3AC01 3RU29 26-3AC01	0.04 0.06
<b>Mechanical RESET</b>					
 with pushbutton, and reset extension 3RU29 00-1A	<b>Resetting plunger, holder, and former overload reset adapter</b>		S00 to S3	3RU29 00-1A	0.038
	<b>Pushbuttons with extended stroke</b>		S00 to S3	3SU1200-0FB10-0AA0	0.020
	<b>Extension plungers</b>		S00 to S3	3SU1900-0KG10-0AA0	0.004
	<b>Complete mechanical reset assembly</b>		S00 to S3	3SBES-RESET	
<b>Cable release with holder for RESET</b>					
 3RU29 00-1	For drilled hole Ø 6.5 mm in the control panel max. control panel thickness 8 mm	Length 400 mm	S00 to S3	3RU29 00-1B 3RU29 00-1C	0.063
		Length 600 mm	S00 to S3		0.073
<b>Module for remote RESET, electrical</b>					
 3RU19 00-2A.71	Operating range 0.85 to 1.1 × U <sub>s</sub> Power consumption AC 80 VA, DC 70 W ON period 0.2 s to 4 s AC/DC 24 V to 30 V AC/DC 110 V to 127 V AC/DC 220 V to 250 V		S00 to S3	3RU19 00-2AB71 3RU19 00-2AF71 3RU19 00-2AM71	0.066 0.066 0.066
<b>Terminal cover</b>					
 3RT1946-4EA1	Cover for cable lug and bar connection		S3	3RT19 46-4EA1	0.040
	Cover for box terminals		S2 S3	3RT29 36-4EA2 3RT29 46-4EA2	0.020 0.025
<b>Sealable covers</b>					
 3RV29 08-0P	For covering the rotary setting dials. Order in multiples of 10.		S00 to S2	3RV29 08-0P	0.100
<b>Tool for opening Spring Loaded terminal connections</b>					
 3RA2908-1A	Suitable up to a For all SIRIUS devices with spring-type terminals			3RA2908-1A	0.045
	<ul style="list-style-type: none"> <li>Length: approx. 200 mm; 3.0 × 0.5 mm (green)</li> </ul>				

<sup>1)</sup> The accessories are identical to those of the 3RB30/3RB31 solid-state overload relays.

# Thermal Overload Relays

3RU21 up to 100 A, CLASS 10

OVERLOAD RELAYS 3

**Technical data**

Type	3RU21 16	3RU21 26	3RU21 36	3RU21 46
Size	S00	S0	S2	S3
Width	45 mm	45 mm	55 mm	70 mm

**General data**

<b>Release on</b>	overload or phase failure			
<b>Trip class</b>	acc. to IEC 60947-4-1	CLASS 10	10, 10A	10
<b>Phase failure sensitivity</b>	Yes			
<b>Overload warning</b>	No			
<b>Resetting and recovery</b>	Manual, remote and automatic RESET <sup>1)</sup>			
Reset possibilities after tripping	depending on the level of tripping current and the tripping characteristic			
Recovery time	on automatic RESET	min	depending on the level of tripping current and the tripping characteristic	
	on manual RESET	min		
	on remote RESET	min		

**Features**

Indication of status on the device	Yes, using the slide "TEST function/ON-OFF indicator"			
TEST function	Yes			
RESET button	Yes			
STOP button	Yes			

**Safe operation of motors with "increased safety" type of protection**

EC type test certificate number according to directive 94/9/EC (ATEX)	DMT 98 ATEX G 001  II (2) GD	On request
---	------------------------------	------------

**Ambient temperatures**

Storage/transport	°C	-55 to +80	-55 to +80
Operation	°C	-40 to +70	-40 to +70
Temperature compensation	°C	up to +60	up to +60
Permissible rated current at	Internal cabinet temperature of 60 °C	%	100 (over +60°C, current reduction is not required)
	Internal cabinet temperature of 70 °C	%	87

**Repeat terminals**

Repeat coil terminal	Yes	Not required
Auxiliary switch repeat terminal	Yes	Not required

**Degree of protection**

acc. to IEC 60529	IP 20	IP 20 <sup>2)</sup>
-------------------	-------	---------------------

**Touch protection**

acc. to IEC 61140	Finger-safe for vertical contact from the front Finger-safe only with optional terminal covers	
-------------------	---	--

**Shock resistance (sine)**

acc. to IEC 60068-2-27	g/ms	15/11 (auxiliary contacts 95/96 and 97/98: 8g/11ms)	8/10
------------------------	------	---	------

**EMC**

• Interference immunity	Not relevant		
• Emitted interference	Not relevant		

**Resistance to extreme climates (humidity)**

%	90	100
---	----	-----

**Dimensions**

	see dimensional drawings		
--	--------------------------	--	--

**Site altitude**

m	Up to 2000; above this on request		
---	-----------------------------------	--	--

**Installation angle**

The permissible installation angles for mounting onto contactors and individual mounting are shown in the diagrams. For mounting in the shaded area, adjustment compensation of 10 % is necessary.

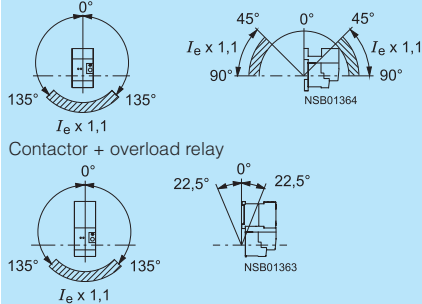

**Type of installation/mounting**

	Mounting onto contactor/stand-alone installation with terminal support (For screw and snap-on mounting onto TH 35 standard mounting rail)	Direct mounting/stand-alone installation with terminal support (For screw and snap-on mounting onto TH34 standard mounting rail size; size S3 also for TH 75 standard mounting rail.*
--	---	---

1) Remote RESET in combination with the appropriate accessories.  
2) Terminal compartment: IP 00 degree of protection.

Technical data					
Type		3RU21 16	3RU21 26	3RU21 36	3RU21 46
Size		S00	S0	S2	S3
Width		45 mm	45 mm	55 mm	70 mm
Main circuit					
Rated insulation voltage $U_i$ (pollution degree 3)	V	690			1000
Rated impulse withstand voltage $U_{imp}$	kV	6			8
Rated operational voltage $U_e$	V	690			1000
Type of current	DC AC	Yes Yes, frequency range up to 400 Hz			
Current setting	A	0.11– 0.16 to 11 – 16	1.8 – 2.5 to 34 – 40	11-16 up to 70-80	18 – 25 to 80 – 100
Power loss per device (max.)	W	4.1...6.3	6.2...7.5	8...14	10 to 16.5
Short-circuit protection	With fuse without contactor With fuse and contactor	See selection and ordering data See technical data (short-circuit protection with fuses / circuit-breaker for motor feeders)			
Protective separation between main and auxiliary current paths	V	440 440	690: Setting ranges $\leq 25$ A 440: Setting ranges $> 25$ A	690 690	690
Acc. to IEC 60947-1, • Screw terminals or ring terminal lug connections • Spring - type terminals					
Connection of the main circuit					
Type of connection		Screw terminals			Screw connection with box terminal <sup>2)</sup> / bar connection
Screw terminals					
• Terminal screw		M3, Pozidriv size 2	M4, Pozidriv size 2	M6, Pozidriv size 2	Hexagon socket screw 4 mm
• Operating devices	mm	$\varnothing 5 \dots 6$	$\varnothing 5 \dots 6$	$\varnothing 5 \dots 6$	$\varnothing 5 \dots 6$
• Tightening torque	Nm	0.8 to 1.2	2 to 2.5	3 to 4.5	4 to 6
• Conductor cross-section (min./max.), 1 or 2 wires	Solid or stranded	mm <sup>2</sup> 2 × (0.5 to 1.5), 2 × (0.75 to 2.5), max. 2 × 4	2 × (1 to 2.5), 2 × (2.5 to 6), max. 2 × (2.5 to 10)	2x(2.5 to 35) 1x(2.5 to 50)	2 × (2.5 to 16)
	Finely stranded with end sleeve	mm <sup>2</sup> 2 × (0.5 to 1.5), 2 × (0.75 to 2.5)	2 × (1 to 2.5), 2 × (2.5 to 6) max. 1 × 10	2 × (1 to 25) 1 × (1 to 35)	2 × (2.5 to 35), 1 × (2.5 to 50)
	AWG conductor con., solid or stranded	AWG 2 × (20 ... 16) 2 × (18 ... 14) 2 × 12	2 × (16 ... 12) 2 × (14 ... 8)	2 × (18 to 2) 1 × (18 to 1)	2 × (10 to 1/0), 1 × (10 to 2/0)
	Ribbon cable (No. × width × thickness)	mm	–	–	2 × (6 × 9 × 0.8)
Bar connection					
• Terminal screw		–	–	–	M 6 × 20
• Tightening torque	Nm	–	–	–	4 to 6
• Conductor cross-section (min./max.)	Finely stranded with cable lug	mm <sup>2</sup>	–	–	2 × 70
	Stranded with cable lug	mm <sup>2</sup>	–	–	2 × 70
	AWG conductor connections, solid or stranded with cable lug	AWG	–	–	2/0
	With connecting bars (max. width)	mm	–	–	12
Auxiliary circuit					
Main contacts: Number of NO contacts		1			
Number of NC contacts		1			
Assignment of auxiliary contacts		1 NO for the signal "tripped"; 1 NC for disconnecting the contactor			
Rated insulation voltage $U_i$ (pollution degree 3)	V	690			
Rated impulse withstand voltage $U_{imp}$	kV	6			
Switching capacity of auxiliary contacts					
NC for AC AC-14/AC-15	Rated operational current $I_e$ at $U_e$ :	A	4 4 4 3 2 0.75 0.75		
	• 24 V	A	4		
	• 120 V	A	4		
	• 125 V	A	4		
	• 230 V	A	3		
	• 400 V	A	2		
	• 600 V	A	0.75		
	• 690 V	A	0.75		

1) For conductor cross-sections for Cage Clamp terminals, see "Connection of the auxiliary circuit."

2) The box terminal can be removed. After the box terminal has been removed, bar connection and lug connection is possible.

# Thermal Overload Relays

3RU21 up to 100 A, CLASS 10

OVERLOAD RELAYS 3

## Technical data

Type			3RU21 16	3RU21 26	3RU21 36	3RU11 46	
Size			S00	S0	S2	S3	
Width			45 mm	45 mm	55 mm	70 mm	
NO for AC AC-14/AC-15	Rated operational current $I_e$ at $U_e$ :	• 24 V	A	3			3
		• 120 V	A	3			3
		• 125 V	A	3			3
		• 230 V	A	2			2
		• 400 V	A	1			1
		• 600 V	A	0.75			0.6
		• 690 V	A	0.75			0.5
NC, NO for DC DC-13	Rated operational current $I_e$ at $U_e$ :	• 24 V	A	1			1
		• 60 V	A	On request			On request
		• 110 V	A	0.22			0.22
		• 125 V	A	0.22			0.22
		• 220 V	A	0.11			0.11
		Conventional thermal current $I_{th}$		A	6		
Contact reliability	(suitable for PLC; 17 V, 5 mA)		Yes			Yes	
<b>Short-circuit protection</b>							
With fuse	Utilization cat. gL/gG fast	A	6				
		A	10				
<b>With miniature circuit-breaker (C characteristic)</b>		A	6 <sup>1)</sup>				
<b>Reliable operational voltage for protective separation between auxiliary current paths</b>		acc. to IEC 60947-1	V	440			

## Connection of the auxiliary circuit

Type of connection			Screw terminal or Cage Clamp terminal	
Connection characteristics			Screw terminals	Cage Clamp terminals
• Terminal screw			Pozidrive Size 2	–
• Tightening torque		Nm	0.8 to 1.2	2 × (0.25 to 2.5)
• Conductor cross-sections (min./max.), 1 or 2 wires	Solid or stranded	mm <sup>2</sup>	2 × (0.5 to 1.5), 2 × (0.75 to 2.5)	2 × (0.25 to 2.5)
	Finely stranded without end sleeve	mm <sup>2</sup>	–	2 × (0.25 to 2.5)
	Finely stranded with end sleeve	mm <sup>2</sup>	2 × (0.5 to 1.5), 2 × (0.75 to 2.5)	2 × (0.25 to 1.5)
	AWG conductor connections, solid or stranded	AWG	2 × (20 to 16) 2 × (18 to 14)	2 × (20 to 14)

1) Up to  $I_k \leq 0.5$  kA;  $\leq 260$  V.

# Thermal Overload Relays

3RU21 up to 100 A, CLASS 10

## Circuit diagrams

### Protection of DC motors

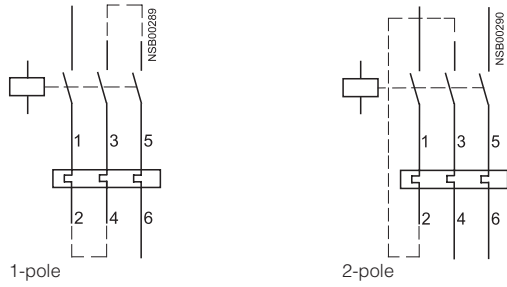

### 3RU21 16 overload relay

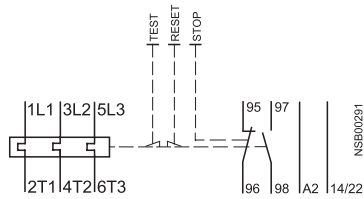

### 3RU21 26 to 3RU21 46 overload relays

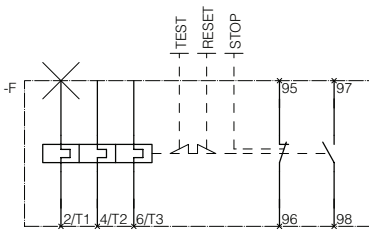



# Thermal Overload Relays

3RU21 up to 100 A, CLASS 10

## Dimension drawings

### Screw connection

Lateral clearance to grounded components: at least 6 mm.

**3RU21 16-..B0**  
Size S00

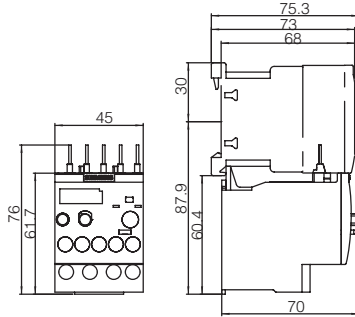

**3RU21 16-..B1**  
Size S00

with adapter for installation as a single unit with accessories

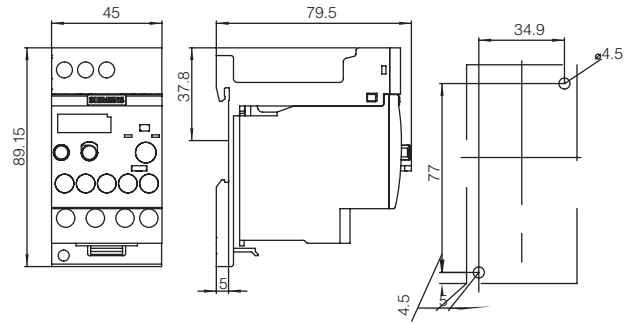

**3RU21 26-..B.**  
Size S0

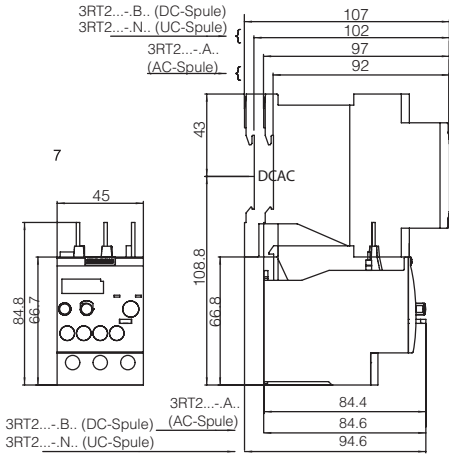

**3RU21 26-..B1**  
Size S0

with adapter for installation as a single unit

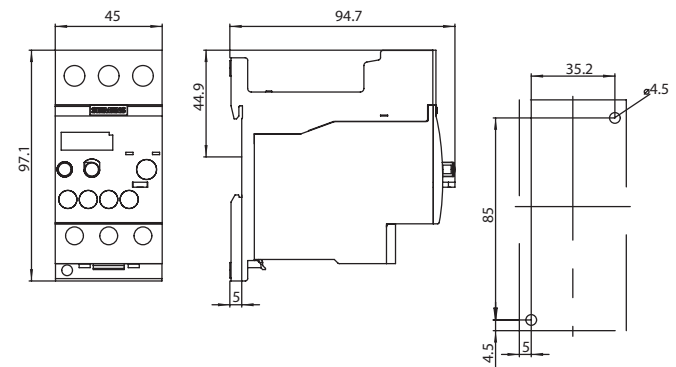

**3RU21 36-..B.**  
Size S2

with adapter for installation as a single unit

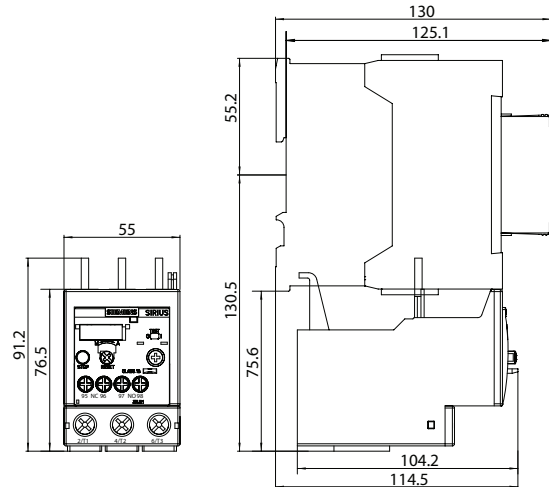

**3RU21 46-..B.**  
Size S3

with adapter for installation as a single unit

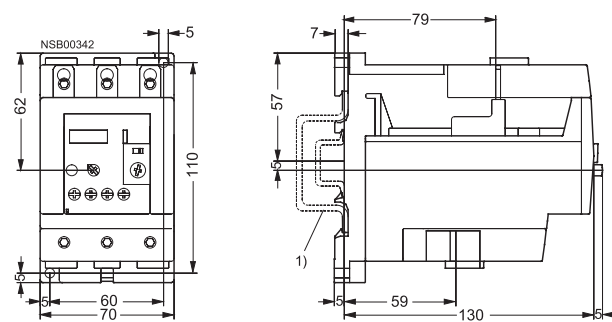

1) For mounting on 35 mm standard mounting rail (15 mm deep) acc. to EN 50 022 or 75 mm standard mounting rail acc. to EN 50023

Dimension drawings "Contactor with built-on overload relay" see contactors and contactor combinations.

### Dimension drawings

#### Spring Loaded terminals

Lateral clearance to grounded components: at least 6 mm.

**3RU21 16 -..C0**  
Size S00

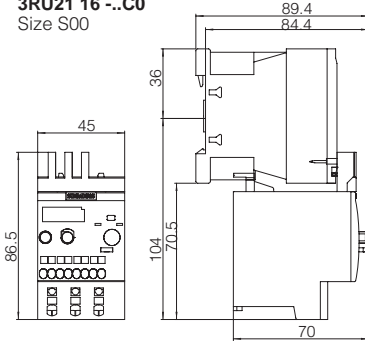

**3RU21 16 -..C1**

Size S00 with with adapter for installation as a single unit

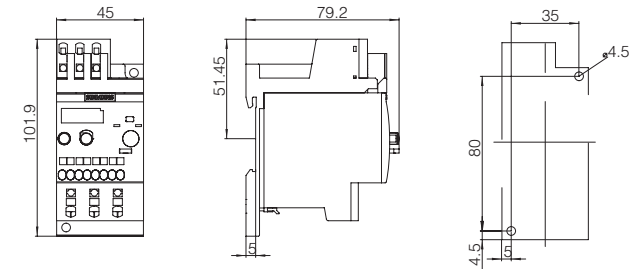

**3RU21 26-..C0**

Size S0

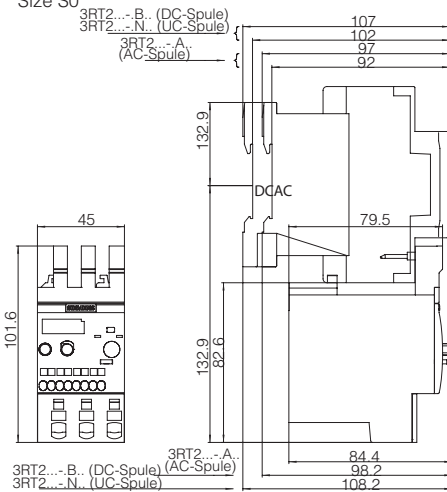

**3RU21 26-..C1**

Size S0 with adapter for installation as a single unit

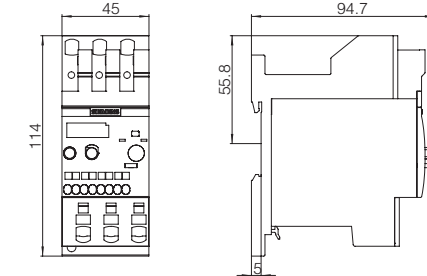

**3RU11 46-..D.**

Size S3

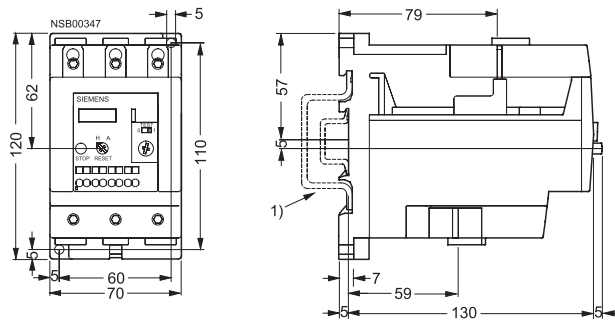

**3RU2136-..D.**

Size S2

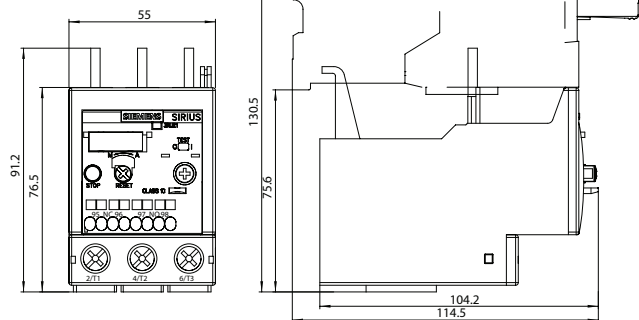

1) For mounting on 35 mm standard mounting rail (15 mm deep) acc. to EN 50 022 or 75 mm standard mounting rail acc. to EN 50 023

Dimension drawings "Contactor with built-on overload relay" see contactors and contactor combinations.

# 3RB2 / 3RB3 Solid-State Overload Relays

3RB20, 3RB21, 3RB30, 3RB31 up to 630A for standard applications

## Overview

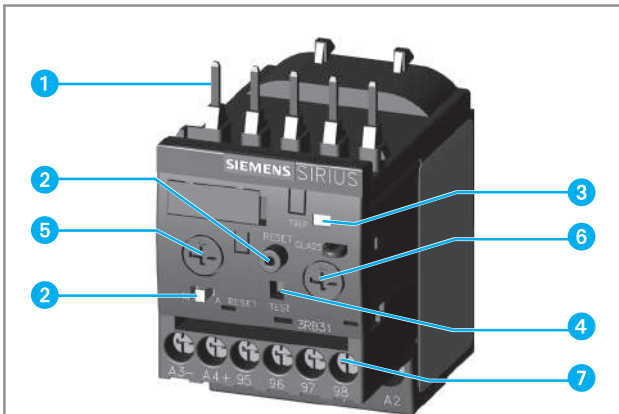

- 1 Connection for mounting onto contactors:**  
Optimally adapted in electrical, mechanical and design terms to the contactors. The overload relay can be connected directly to these contactor using these pins. Stand-alone installation is possible as an alternative (in conjunction with a terminal bracket for stand-alone installation).
- 2 Selector switch for manual/automatic RESET and RESET button:**  
With this switch you can choose between manual and automatic RESET. A device set to manual RESET can be reset locally by pressing the RESET button. On the 3RB21 a solid-state remote is integrated into the unit.
- 3 Switch position indicator and TEST function of the wiring:**  
Indicates a trip and enables the wiring test.
- 4 Solid state test:**  
Enables a test of all important device components and functions.
- 5 Motor current setting:**  
Setting the device to the rated motor current is easy with the large rotary knob.
- 6 Trip class setting/internal ground-fault detection (3RB21 only):**  
Using the rotary switch you can set the required trip class and activate the internal ground-fault detection dependent on the starting conditions.
- 7 Connecting terminals (removable terminal block for auxiliary circuits):**  
The generously sized terminals permit connection of two conductors auxiliary circuit can be connected with screw-type terminals or with spring-loaded terminals.

The 3RB and 3RB solid-state overload relays up to 630 A with internal power supply have been designed for inverse-time delayed protection of loads with normal and heavy starting (see [Function](#)) against excessive temperature rise due to overload, phase unbalance or phase failure. An overload, phase unbalance or phase failure result in an increase of the motor current beyond the set motor rated current. This current rise is detected by the current transformers integrated into the devices and evaluated by corresponding solid-state circuits which then output a pulse to the auxiliary contacts. The auxiliary contacts then switch off the load by means of the contactors control circuit. The break time depends on the ratio between the tripping current and set current  $I_e$  and is stored in the form of a long-term stable tripping characteristic (see [Characteristic Curves](#)).

In addition to inverse-time delayed protection of loads against excessive temperature rise due to overload, phase unbalance and phase failure, the 3RB21/31 solid-state overload relays also allow internal ground-fault detection (not possible in conjunction with wye-delta assemblies). This provides protection of loads against high-resistance short-circuits due to damage to the insulation material, moisture, condensed water etc.

The "tripped" status is signaled by means of a switch position indicator (see [Function](#)). Resetting takes place either manually or automatically after the recovery time has elapsed (see [Function](#)).

The devices are manufactured in accordance with environmental guidelines and contain environmentally friendly and reusable materials. They comply with important worldwide standards and approvals.

## Application

### Industries

The 3RB2 / 3RB3 solid-state overload relays are suitable for customers from all industries who want to provide optimum inverse-time delayed protection of their electrical loads (e.g. motors) under normal and heavy starting conditions (CLASS 5 to CLASS 30), minimize project completion times, inventories and power consumption, and optimize plant availability and maintenance management.

### Application

The 3RB2 / 3RB3 solid-state overload relays have been designed for the protection of three-phase motors in sinusoidal 50/60 Hz voltage networks. The relays are not suitable for the protection of single-phase AC or DC loads.

The 3RU thermal overload relay or the 3RB22/3RB23 solid-state overload relay can be used for single-phase AC loads. For DC loads the 3RU thermal overload relays are available.

### Ambient conditions

The devices are insensitive to external influences such as shocks, corrosive environments, ageing and temperature changes.

For the temperature range from  $-25\text{ °C}$  to  $+60\text{ °C}$ , the 3RB2 / 3RB3 solid-state overload relays compensate the temperature according to IEC 60947-4-1.

The 3RB2 / 3RB3 solid-state overload relays are suitable for the overload protection of explosion-proof motors with "increased safety" type of protection EEx e according to ATEX guideline 94/9/EC. The relays meet the requirements of EN 60079-7 (Electrical apparatus for potentially explosive atmospheres – Increased safety "e").

The basic safety and health requirements of ATEX guideline 94/9/EG are fulfilled by compliance with

- EN 60947-1
- EN 60947-4-1
- EN 60947-5-1
- EN 60079-14

EU type test certificate for Group II, Category (2) G/D under application. It has the number PTB 09 ATEX 3001.

## Accessories

The following accessories are available for the 3RB2/3RB3 solid-state overload relays:

- One terminal bracket each for the overload relays size S00 and S0 (sizes S2 to S12 can be installed as single units without a terminal bracket)
- One mechanical remote RESET module for all sizes
- One cable release for resetting devices which are difficult to access (for all sizes)
- One sealable cover for all sizes
- Box terminals for sizes S6 and S10/S12
- Terminal covers for sizes S2 to S10/S12

# 3RB2 / 3RB3 Solid-State Overload Relays

3RB20, 3RB21, 3RB30, 3RB31 up to 630A for standard applications

## Design

### Device concept

The 3RB2 / 3RB3 solid-state overload relays are compact devices, i.e. current measurement (transformer) and the evaluation unit are integrated in a single enclosure.

### Mounting options

The 3RB2 / 3RB3 solid-state overload relays are suitable for direct and space-saving mounting onto 3RT1 / 3RT2 contactors and 3RW30/3RW31 soft starters as well as for stand-alone installation. For more information on the mounting options, please see [Technical Specifications and Selection and Ordering Data](#)

### Connection technique

#### Main circuit

All sizes of the 3RB2 / 3RB3 solid-state overload relays can be connected with screw-type terminals. As an alternative for sizes S3 to S10/S12, the main circuits can be connected via the Busbar. Sizes S2 to S6 of the 3RB20/3RB21 relays are also available with a straight-through transformer. In this case, the cables of the main circuit are routed directly through the feed-through openings of the relay to the contactor terminals.

#### Auxiliary circuit

Connection of the auxiliary circuit (removable terminal block) is possible with either screw terminals or spring-loaded terminals.

For more information on the connection options, see [Technical Specifications and Selection and Ordering Data](#).

### Overload relays in contactor assemblies for Wye-Delta starting

When overload relays are used in combination with contactor assemblies for Wye-Delta starting it must be noted that only 0.58 times the motor current flows through the line contactor. An overload relay mounted onto the line contactor must be set to 0.58 times the motor current.

When 3RB21 / 31 solid-state overload relays are used in combination with contactor assemblies for Wye-Delta starting, the internal ground-fault detection must not be activated.

### Operation with frequency converter

The 3RB2 / 3RB3 solid-state overload relays are suitable for frequencies of 50/60 Hz and the associated harmonics. This permits the 3RB2 / 3RB3 overload relays to be used on the incoming side of the frequency converter.

If motor protection is required on the outgoing side of the frequency converter, the 3RN thermistor motor protection devices or the 3RU thermal overload relays are available for this purpose.

## 3RB2 / 3RB3 Solid-State Overload Relays

3RB20, 3RB21, 3RB30, 3RB31 up to 630A for standard applications

**Function****Basic functions**

The 3RB2 / 3RB3 solid-state overload relays are designed for:

- Inverse-time delayed protection of loads from overloading
- Inverse-time delayed protection of loads from phase unbalance
- Inverse-time delayed protection of loads from phase failure
- Protection of loads from high-resistance short-circuits (internal ground-fault detection only with 3RB21 / 31).

**Control circuit**

The 3RB2 / 3RB3 solid-state overload relays have an internal power supply, i.e. no additional supply voltage is required.

**Short-circuit protection**

Fuses or motor starter protectors must be used for short-circuit protection. For assignments of the corresponding short-circuit protection devices to the 3RB2 / 3RB3 solid-state overload relays with/without contactor see [Technical Specifications and Selection and Ordering Data](#).

**Trip classes**

The 3RB20 / 30 solid-state overload relays are available for normal starting conditions with trip CLASS 10 or for heavy starting conditions with trip CLASS 20 (fixed setting in each case).

The 3RB21 / 31 solid-state overload relays are suitable for normal and heavy starting. The required trip class (CLASS 5, 10, 20 or 30) can be adjusted by means of a rotary knob depending on the current starting condition.

For details of the trip classes see [Characteristic Curves](#).

**Phase failure protection**

The 3RB2 / 3RB3 solid-state overload relays are fitted with phase failure protection (see [Characteristic Curves](#)) in order to minimize temperature rise of the load during single-phase operation.

Phase failure protection is not effective for loads with star-connection and a grounded neutral point or a neutral point which is connected to a neutral conductor.

**Setting**

The 3RB2 / 3RB3 solid-state overload relays are set to the motor rated current by means of a rotary knob. The scale of the rotary knob is shown in amps.

With the 3RB21 / 31 solid-state overload relay it is also possible to select the trip class (CLASS 5, 10, 20 or 30) using a second rotary knob and to switch the internal ground-fault detection on and off.

**Manual and automatic reset**

In the case of the 3RB2 / 3RB3 solid-state overload relays, a slide switch can be used to choose between automatic and manual resetting.

If manual reset is set, a reset can be carried out directly on the device after a trip by pressing the blue RESET button. Resetting is possible in combination with the mechanical reset options from the accessories range (see [Accessories](#)). As an alternative to the mechanical RESET options, the 3RB21 / 31 solid-state overload relays are equipped with an electrical remote RESET which may be utilized by applying a voltage of 24 V DC to the terminals A3 and A4.

If the slide switch is set to automatic RESET, the relay is reset automatically.

The time between tripping and resetting is determined by the recovery time.

**Recovery time**

With the 3RB2 / 3RB3 solid-state overload relays the recovery time after inverse-time delayed tripping is between 0.5 and 3 minutes depending on the preloading when automatic RESET is set. These recovery times allow the load (e.g. motor) to cool down.

If the button is set to manual RESET, the 3RB2 / 3RB3 devices can be reset immediately after inverse-time delayed tripping.

After a ground fault trip the 3RB21 / 31 solid-state overload relays (with ground-fault detection activated) can be reset immediately without a recovery time regardless of the reset mode set.

**TEST function**

With motor current flowing, the TEST button can be used to check whether the relay is working correctly (device/solid-state TEST). Current measurement, motor model and trip unit are tested. If these components are OK, the device is tripped in accordance with the table below. If there is an error, no tripping takes place.

Trip class	Required loading with the rated current prior to pressing the test button	Tripping within
CLASS 5	2 min	8 s
CLASS 10	4 min	15 s
CLASS 20	8 min	30 s
CLASS 30	12 min	45 s

Note: The test button must be kept pressed throughout the test.

Testing of the auxiliary contacts and the control current wiring is possible with the switch position indicator slide. Actuating the slide simulates tripping of the relay. During this simulation the NC contact (95-96) is opened and the NO contact (97-98) is closed. This tests whether the auxiliary circuit has been correctly wired.

After a test trip the relay is reset by pressing the RESET button.

**Self-monitoring**

The 3RB2 / 3RB3 solid-state overload relays have a self-monitoring feature, i.e. the devices constantly monitor their own basic functions and trip if an internal fault is detected.

**Display of operating status**

The respective operating status of the 3RB2 / 3RB3 solid-state overload relays is displayed by means of the position of the marking on the switch position indicator slide. After tripping due to overload, phase failure, phase unbalance or ground fault (ground fault detection possible only with 3RB21 / 31) the marking on the slide is to the left on the "O" mark, otherwise it is on the "I" mark.

**Auxiliary contacts**

The 3RB2 / 3RB3 solid-state overload relays are fitted with an NO contact for the "tripped" signal, and an NC contact for switching off the contactor.

# 3RB2 / 3RB3 Solid-State Overload Relays

3RB20, 3RB21, 3RB30, 3RB31 up to 630A for standard applications

## Selection and ordering data

Conversion aid 3RB10 or 3RB20 → 3RB20 or 30

Size	Old Order No.	Setting range A	New Order No.	Setting range A
S00	3RB20 16-□RB0	0.1 ... 0.4	3RB30 16-□RB0	0.1 ... 0.4
	3RB20 16-□NB0	0.32 ... 1.25	3RB30 16-□NB0	0.32 ... 1.25
	3RB20 16-□PB0	1 ... 4	3RB30 16-□PB0	1 ... 4
	3RB20 16-□SB0	3 ... 12	3RB30 16-□SB0	3 ... 12
S0	3RB20 26-□RB0	0.1 ... 0.4	3RB30 26-□RB0	0.1 ... 0.4
	3RB20 26-□NB0	0.32 ... 1.25	3RB30 26-□NB0	0.32 ... 1.25
	3RB20 26-□PB0	1 ... 4	3RB30 36-□PB0	1 ... 4
	3RB20 26-□SB0	3 ... 12	3RB30 26-□SB0	3 ... 12
	3RB20 26-□QB0	6 ... 25	3RB30 26-□QB0	6 ... 25
S2	3RB20 36-□QB0	6 ... 25	3RB30 36-□UB0	12.5 ... 50
	3RB20 36-□UB0	13 ... 50	3RB30 36-□WB0	20 ... 80
S3	3RB10 46-□UB0	13 ... 50	3RB30 46-□UB0	12.5 ... 50
	3RB10 46-□EB0	25 ... 100	3RB30 46-□XB0	32 ... 115
S6	3RB10 56-□FW0	50 ... 200	3RB20 56-□FW2	50 ... 200
	3RB10 56-□FG0	50 ... 200	3RB20 56-□FC2	50 ... 200
S10/S12	3RB10 66-□GG0	55 ... 250	3RB20 66-□GC2	55 ... 250
	3RB10 66-□KG0	200 ... 540		
	3RB10 66-□LG0	300 ... 630	3RB20 66-□MC2	160 ... 630

CLASS 10  
CLASS 20

1  
2

1  
2

Conversion aid 3RB10 / 21 → 3RB21 / 31

Size	Old Order No.	Setting range A	New Order No.	Setting range A
S00	3RB21 13-□RB0	0.1 ... 0.4	3RB31 13-4RB0	0.1 ... 0.4
	3RB21 13-□NB0	0.4 ... 1.6	3RB31 13-4NB0	0.32 ... 1.25
	3RB21 13-□PB0	1.5 ... 6	3RB31 13-4PB0	1 ... 4
	3RB21 13-□SB0	3 ... 12	3RB31 13-4SB0	3 ... 12
S0	3RB21 23-□RB0	0.1 ... 0.4	3RB31 23-4RB0	0.1 ... 0.4
	3RB21 23-□NB0	0.32 ... 1.25	3RB31 23-4NB0	0.32 ... 1.25
	3RB21 23-□PB0	1 ... 4	3RB31 23-4PB0	1 ... 4
	3RB21 23-□SB0	3 ... 12	3RB31 23-4SB0	3 ... 12
	3RB21 23-□QB0	6 ... 25	3RB31 23-4QB0	6 ... 25
S2	3RB21 33-□QB0	6 ... 25	3RB31 33-4UB0	12.5 ... 50
	3RB21 33-□UB0	13 ... 50	3RB31 33-4WB0	20 ... 80
S3	3RB10 46-□UB0	12.5 ... 50	3RB31 43-4UB0	12.5 ... 50
	3RB10 46-□EB0	25 ... 100	3RB31 43-4XB0	32 ... 115
S6	3RB10 56-□FW0	50 ... 200	3RB21 53-4FW2	50 ... 200
	3RB10 56-□FG0	50 ... 200	3RB21 53-4FC2	50 ... 200
S10/S12	3RB10 66-□GG0	55 ... 250	3RB21 63-4GC2	55 ... 250
	3RB10 66-□KG0	200 ... 540		
	3RB10 66-□LG0	300 ... 630	3RB21 63-4MC2	160 ... 630

CLASS 10  
CLASS 20

1  
2

Note:

CLASS 5, 10, 20 and 30 can be set on the unit



# 3RB2 / 3RB3 Solid-State Overload Relays







3RB20, 3RB21, 3RB30, 3RB31 up to 630A for standard applications

**3RB20 solid-state overload relays and stand-alone installation<sup>2)3)</sup>, CLASS 10 or CLASS 20 for direct mounting<sup>1)2)</sup>**

Features and technical specifications:

- Overload protection, phase failure protection and unbalance protection
- Internal power supply
- Auxiliary contacts 1 NO + 1 NC
- Manual and automatic RESET
- Switch position indicator
- TEST function and self-monitoring

OVERLOAD RELAYS 3

Size Contactor <sup>4)</sup>	Set current value of the inverse-time delayed overload trip	Screw Terminal Order Number	Spring Loaded Terminal Order Number	Weight per PU approx. kg		
<b>Size S00<sup>1)</sup></b>						
 3RB30 16-1RB0	S00	0.1 ... 0.4	<b>3RB30 16-□RB0</b>	<b>3RB30 16-□RE0</b>	0.172	
		0.32 ... 1.25	<b>3RB30 16-□NB0</b>	<b>3RB30 16-□NE0</b>	0.172	
		1 ... 4	<b>3RB30 16-□PB0</b>	<b>3RB30 16-□PE0</b>	0.172	
		3 ... 12	<b>3RB30 16-□SB0</b>	<b>3RB30 16-□SE0</b>	0.172	
		4 ... 16	<b>3RB30 16-□TB0</b>	<b>3RB30 16-□TE0</b>	0.172	
<b>Size S0<sup>1)</sup></b>						
 3RB30 26-1QB0	S0	0.1 ... 0.4	<b>3RB30 26-□RB0</b>	<b>3RB30 26-□RE0</b>	0.250	
		0.32 ... 1.25	<b>3RB30 26-□NB0</b>	<b>3RB30 26-□NE0</b>	0.250	
		1 ... 4	<b>3RB30 26-□PB0</b>	<b>3RB30 26-□PE0</b>	0.250	
		3 ... 12	<b>3RB30 26-□SB0</b>	<b>3RB30 26-□SE0</b>	0.250	
		6 ... 25	<b>3RB30 26-□QB0</b>	<b>3RB30 26-□QE0</b>	0.250	
	10 ... 40	<b>3RB30 26-□VB0</b>	<b>3RB30 26-□VE0</b>	0.250		
<b>Size S2<sup>1)3)5)</sup></b>						
 3RB30 36-1UB0	S2	12 ... 50	with busbar with pass through CT's	<b>3RB30 36-□UB0</b>	<b>3RB30 36-□UD0</b>	0.360
				<b>3RB30 36-□UW1</b>	<b>3RB30 36-□UX1</b>	0.230
	20 ... 80	with busbar with pass through CT's	<b>3RB30 36-□WB0</b>	<b>3RB30 36-□WD0</b>	0.360	
			<b>3RB30 36-□WW1</b>	<b>3RB30 36-□WX1</b>	0.230	
<b>Size S3<sup>1)3)5)</sup></b>						
 3RB30 46-1XB0	S3	12.5 ... 50	with busbar with pass through CT's	<b>3RB30 46-□UB0</b>	<b>3RB30 46-□UD0</b>	0.560
				<b>3RB30 46-□UW1</b>	<b>3RB30 46-□UX1</b>	0.450
	32 ... 115	with busbar with pass through CT's	<b>3RB30 46-□XB0</b>	<b>3RB30 46-□XD0</b>	0.560	
			<b>3RB30 46-□XW1</b>	<b>3RB30 46-□XX1</b>	0.450	
<b>Size S6<sup>2)5)</sup></b>						
 3RB20 56-1FW2	S6	50 ... 200	with busbar	<b>3RB20 56-□FC2</b>	<b>3RB20 56-□FF2</b>	1.030
			with pass through CT's	<b>3RB20 56-□FW2</b>	<b>3RB20 56-□FX2</b>	0.690
<b>Size S10/S12<sup>2)</sup></b>						
 3RB20 66-1MC2	S10/S12 and size 14 (3TF68/3TF69)	55 ... 250	with busbar	<b>3RB20 66-□GC2</b>	<b>3RB20 66-□GF2</b>	1.820
		160 ... 630	with busbar	<b>3RB20 66-□MC2</b>	<b>3RB20 66-□MF2</b>	1.820

2 Class 20  
1 Class 10

2 Class 20  
1 Class 10

- 1) The relays with an Order No. ending with "0" are designed for direct mounting to the contactor. With the matching terminal brackets (see Accessories) the sizes S00 to S3 can also be installed as stand-alone units.
- 2) The relays with an Order No. ending with "2" are designed for direct mounting and stand-alone installation. For 3TF68/3TF69 contactors, direct mounting is not possible.
- 3) The relays with an Order No. ending with "1" are designed for stand-alone installation.
- 4) Observe maximum rated operational current of the devices.
- 5) The relays with an Order No. with "X" in 10th position are equipped with a straight-through transformer.

For accessories, see pages 3/49-3/50.  
For description, see pages 3/18-3/20.  
For technical data, see pages 3/24-3/29.  
For dimension drawings, see page 3/30.  
For schematic diagrams, see page 3/31.









# 3RB2 / 3RB3 Solid-State Overload Relays

3RB20, 3RB21, 3RB30, 3RB31 up to 630A for standard applications

**3RB21 / 3RB31 solid-state overload relays for direct mounting<sup>1)2)</sup> and stand-alone installation<sup>2)3)</sup>, CLASS 5, 10, 20 and 30 adjustable**

Features and technical specifications:

- Overload protection, phase failure protection and unbalance protection
- Internal ground fault detection (activatable)
- Internal power supply
- Auxiliary contacts 1 NO + 1 NC
- Manual and automatic RESET
- Electrical remote RESET integrated
- Switch position indicator
- TEST function and self-monitoring

Size	Set current value of the inverse-time delayed overload trip	Screw Terminal Order Number	Spring Loaded Terminal Order Number	Weight per PU approx.		
Contactor <sup>4)</sup>	A			kg		
<b>Size S00<sup>1)</sup></b>						
 3RB31 13-4RB0	S00	0.1 ... 0.4	<b>3RB31 13-4RB0</b>	<b>3RB31 13-4RE0</b>	0.175	
		0.32 ... 1.25	<b>3RB31 13-4NB0</b>	<b>3RB31 13-4NE0</b>	0.175	
		1 ... 4	<b>3RB31 13-4PB0</b>	<b>3RB31 13-4PE0</b>	0.175	
		3 ... 12	<b>3RB31 13-4SB0</b>	<b>3RB31 13-4SE0</b>	0.175	
		4 ... 16	<b>3RB31 13-4TB0</b>	<b>3RB31 13-4TE0</b>	0.175	
<b>Size S0<sup>1)</sup></b>						
 3RB31 23-4QB0	S0	0.1 ... 0.4	<b>3RB31 23-4RB0</b>	<b>3RB31 23-4RE0</b>	0.215	
		0.32 ... 1.25	<b>3RB31 23-4NB0</b>	<b>3RB31 23-4NE0</b>	0.215	
		1 ... 4	<b>3RB31 23-4PB0</b>	<b>3RB31 23-4PE0</b>	0.215	
		3 ... 12	<b>3RB31 23-4SB0</b>	<b>3RB31 23-4SE0</b>	0.215	
		6 ... 25	<b>3RB31 23-4QB0</b>	<b>3RB31 23-4QE0</b>	0.215	
	10 ... 40	<b>3RB31 23-4VB0</b>	<b>3RB31 23-4VE0</b>	0.215		
<b>Size S2<sup>1)3)5)</sup></b>						
 3RB31 33-4WB0	S2	12 ... 50	with busbar with pass through CT's	<b>3RB31 33-4UB0</b>	<b>3RB31 33-4UD0</b>	0.360
				<b>3RB31 33-4UW1</b>	<b>3RB31 33-4UX1</b>	0.230
		20 ... 80	with busbar with pass through CT's	<b>3RB31 33-4WB0</b>	<b>3RB31 33-4WD0</b>	0.360
				<b>3RB31 33-4WW1</b>	<b>3RB31 33-4WX1</b>	0.230
<b>Size S3<sup>1)3)5)</sup></b>						
 3RB31 43-4XB0	S3	12.5 ... 50	with busbar with pass through CT's	<b>3RB31 43-4UB0</b>	<b>3RB31 43-4UD0</b>	0.560
				<b>3RB31 43-4UW1</b>	<b>3RB31 43-4UX1</b>	0.450
		32 ... 115	with busbar with pass through CT's	<b>3RB31 43-4XB0</b>	<b>3RB31 43-4XD0</b>	0.560
				<b>3RB31 43-4XW1</b>	<b>3RB31 43-4XX1</b>	0.450
<b>Size S6<sup>2)5)</sup></b>						
 3RB21 53-4FC2	S6	50 ... 200	with busbar	<b>3RB21 53-4FC2</b>	<b>3RB21 53-4FF2</b>	1.030
			with pass through CT's	<b>3RB21 53-4FW2</b>	<b>3RB21 53-4FX2</b>	0.690
<b>Size S10/S12<sup>2)</sup></b>						
 3RB21 63-4MC2	S10/S12 and size 14 (3TF68/3TF69)	55 ... 250	<b>3RB21 63-4GC2</b>	<b>3RB21 63-4GF2</b>	1.820	
		160 ... 630	<b>3RB21 63-4MC2</b>	<b>3RB21 63-4MF2</b>	1.820	

- 1) The relays with an Order No. ending with "0" are designed for direct mounting to the contactor. With the matching terminal brackets (see Accessories) the sizes S00 to S3 can also be installed as stand-alone units.
- 2) The relays with an Order No. ending with "2" are designed for direct mounting and stand-alone installation. For 3TF68/3TF69 contactors, direct mounting is not possible.
- 3) The relays with an Order No. ending with "1" are designed for stand-alone installation.
- 4) Observe maximum rated operational current of the devices.
- 5) The relays with an Order No. with "X" in 10th position are equipped with a straight-through transformer.

For accessories, see pages 3/49-3/50.  
 For description, see pages 3/18-3/21.  
 For technical data, see pages 3/24-3/29.  
 For dimension drawings, see page 3/30.  
 For schematic diagrams, see page 3/31.



# 3RB2 / 3RB3 Solid-State Overload Relays

3RB20, 3RB21, 3RB30, 3RB31 up to 630A for standard applications

3  
OVERLOAD  
RELAYS

## Technical specifications

Type	3RB30 16, 3RB31 13	3RB30 26, 3RB31 23	3RB30 36 3RB31 33	3RB30 46, 3RB31 43	3RB30 56, 3RB31 53	3RB30 66, 3RB31 63
<b>Size</b>	<b>S00</b>	<b>S0</b>	<b>S2</b>	<b>S3</b>	<b>S6</b>	<b>S10/S12</b>
<b>Width</b>	<b>45 mm</b>	<b>45 mm</b>	<b>55 mm</b>	<b>70 mm</b>	<b>120 mm</b>	<b>145 mm</b>
<b>General data</b>						
<b>Trips in the event of</b>	Overload, phase failure, and phase unbalance + ground fault (for 3RB31 only)					
<b>Trip class</b> according to IEC 60947-4-1	CLASS 3RB30: 10E, 20E; 3RB31: 5E, 10E, 20E or 30E adjustable					
<b>Phase failure sensitivity</b>	Yes					
<b>Overload warning</b>					No	
<b>Reset and recovery</b>	Manual and automatic RESET, 3RB31 has an integrated connection for electrical remote RESET (24 V DC)			3RB20: Manual and automatic RESET; 3RB21: Manual, automatic and remote RESET		
• Reset options after tripping						
• Recovery time						
- For automatic RESET	min.	Approx. 3 min		Approx. 3 min		
- For manual RESET	min.	Immediately		Immediately		
- For remote RESET	min.	Immediately		Immediately		
<b>Features</b>	<ul style="list-style-type: none"> <li>• Display of operating status on device</li> <li>• TEST function</li> </ul>					
• RESET button	Yes					
• STOP button	No					
<b>Explosion protection – Safe operation of motors with "Increased safety" type of protection</b>	PTB 09 ATEX 3001 ⊗ II (2) G [Ex e] [Ex d] [Ex px] ⊗ II (2) G [Ex t] [Ex p]		On request	PTB 09 ATEX 3001 ⊗ II (2) G [Ex e] [Ex d] [Ex px] ⊗ II (2) G [Ex t] [Ex p]		
EC type test certificate number according to directive 94/9/EC (ATEX)						
<b>Ambient temperatures</b>						
• Storage/transport	°C	-40 ... +80				
• Operation	°C	-25 ... +60				
• Temperature compensation	°C	+60				
• Permissible rated current at						
- Temperature inside control cabinet 60 °C, stand-alone installation	%	—		100	100	100 or 90 <sup>2)</sup>
- Temperature inside control cabinet 60 °C, mounted on contactor	%	100		100	70	70
- Temperature inside control cabinet 70 °C	%	On request		On request		
<b>Repeat terminals</b>						
• Coil repeat terminal	Yes		Not required			
• Auxiliary contact repeat terminal	Yes		Not required			
<b>Degree of protection</b> according to IEC 60529	IP20				IP20 <sup>3)</sup>	
<b>Touch protection</b> according to IEC 61140	Finger-safe for vertical contact from the front				Finger-safe, for busbar connection with cover	Finger-safe with cover
<b>Shock resistance with sine</b> according to IEC 60068-2-27 9/ms	15/11 (signaling contact 97/98 in position "tripped": 9g/ms)		15/11 (signaling contact 97/98 in "Tripped" position: 8 g/11ms)	15/11 (signaling contact 97/98 in position "tripped": 4 g/11ms)		
<b>Electromagnetic compatibility (EMC) – Interference immunity</b>						
• Conductor-related interference						
- Burst according to IEC 61000-4-4 (corresponds to degree of severity 3)	kV	2 (power ports), 1 (signal ports)				
- Surge according to IEC 61000-4-5 (corresponds to degree of severity 3)	kV	2 (line to earth), 1 (line to line)				
• Electrostatic discharge according to IEC 61000-4-2 (corresponds to degree of severity 3)	kV	8 (air discharge), 6 (contact discharge)				
• Field-related interference according to IEC 61000-4-3 (corresponds to degree of severity 3)	V/m	10				
<b>Electromagnetic compatibility (EMC) – Emitted interference</b>	Degree of severity B according to EN 55011 (CISPR 11) and EN 55022 (CISPR 22)					
<b>Resistance to extreme climates – air humidity</b>	%	95			100	
<b>Dimensions</b>	See dimensional drawings					
<b>Installation altitude above sea level</b>	m	Up to 2000				
<b>Mounting position</b>	Any					
<b>Type of mounting</b>	Direct mounting/stand-alone installation with terminal support				Direct mounting / Stand-alone installation	

1) Permissible rated current in case of heavy starting  
Size S0 at 10 A up to 40 A  
- CLASS 20, I<sub>e</sub> max = 32 A  
- CLASS 30, I<sub>e</sub> max = 25 A

2) 90 % for relay with current setting range 160A to 630A  
3) Terminal compartment: degree of protection IP00.

# 3RB2 / 3RB3 Solid-State Overload Relays

3RB20, 3RB21, 3RB30, 3RB31 up to 630A for standard applications

Type		3RB30 16, 3RB31 13 S00 45 mm	3RB30 26, 3RB31 23 S0 45 mm	3RB30 36, 3RB31 33 S2 55 mm	3RB30 46, 3RB31 43 S3 70 mm
<b>Main circuit</b>					
Rated insulation voltage $U_i$ (pollution degree 3)	V	690	690	690	1000
Rated impulse withstand voltage $U_{imp}$	kV	6	6	6/8	8
Rated operational voltage $U_e$	V	690	690	690	1000
Type of current • Direct current • Alternating current		No Yes, 50/60 Hz ± 5%			
Set current	A	0.1 ... 0.4 to 4 ... 16	0.1 ... 0.4 to 10 ... 40	12.5 ... 50 and 20 to 80	12.5 ... 50 to 25 ... 100
Power loss per unit (max.)	W	0.05 ... 0.2			0.05
Short-circuit protection - With fuse without contactor - With fuse and contactor		See Selection and Ordering Data See Technical Specifications (short-circuit protection with fuses for motor feeders)			
Protective separation between main and auxiliary conducting path according to IEC 60947-1 (pollution degree 2)	V	690 for grounded networks, otherwise 600 V			
<b>Connection for main circuit</b>					
Electrical connection version		Screw terminal	Screw terminal	Screw terminal	Screw terminal with box terminal /
<b>Screw terminal</b>					
• Terminal screw • Tightening torque • Conductor cross-sections (min./max.) - Solid or stranded	Nm  mm <sup>2</sup>	M3, Pozidriv size 2 0.8 ... 1.2  2 × (0.5 ... 1.5) <sup>3)</sup> 2 × (0.75 ... 2.5) <sup>3)</sup> 2 × (0.05 ... 4) <sup>3)</sup>	M3, Pozidriv size 2 2 ... 2.5  2 × (1 ... 2.5) <sup>3)</sup> 2 × (2.5 ... 10)	M4, Pozidriv size 2 2 ... 2.5  1 × (1 ... 50) 2 × (1 ... 35) (Solid or Stranded)	M8, 4 mm Allen screw 4 ... 6  2 × (2.5 ... 16)
- Finely stranded with end sleeve (DIN 46228 T1)	mm <sup>2</sup>	2 × (0.5 ... 1.5) <sup>3)</sup> 2 × (0.75 ... 2.5) <sup>3)</sup>	2 × (1 ... 2.5) <sup>3)</sup> 2 × (2.5 ... 6) <sup>3)</sup> max. 1 × 10	2 × (1 ... 25), 1 × (1 ... 35)	2 × (2.5 ... 35), 1 × (2.5 ... 50)
- Stranded	mm <sup>2</sup>	--			2 × (10 ... 50), 1 × (10 ... 70)
- AWG cables, solid or stranded	AWG	2 × (20 ... 16) <sup>3)</sup> 2 × (18 ... 14) <sup>3)</sup> 2 × 12	2 × (16 ... 12) <sup>3)</sup> 2 × (14 ... 8) <sup>3)</sup>	2 × (18 ... 2) 1 × (18 ... 1)	2 × (10 ... 1/0), 2 × (10 ... 2/0)
- Ribbon cable conductors (number x width x circumference)	mm	--			2 × (6 × 9 × 0.8)
<b>Busbar connections</b>					
• Terminal screw • Tightening torque • Conductor cross-section (min./max.) - Finely stranded with cable lug - Stranded with cable lug - AWG connections, solid or stranded, with cable lug - With connecting bar (max. width)	Nm  mm <sup>2</sup> mm <sup>2</sup> AWG mm	-- -- -- -- --			M 6 × 20 4 ... 6  2 × 70 3 × 70 2/0 12
<b>Straight-through transformers</b>					
• Diameter of opening	mm	--		15	18

1) For version with straight-through transformer up to 1000 VAC.  
2) For version with straight-through transformer up to 8 kV.

3) If two different conductor cross-sections are connected to one clamping point, both cross-sections must lie in the range specified.



## 3RB2 /3RB3 Solid-State Overload Relays

3RB20, 3RB21, 3RB30, 3RB31 up to 630A for standard applications

Type	3RB20 56, 3RB21 53	3RB20 66, 3RB21 63
<b>Size</b>	<b>S6</b>	<b>S10/S12</b>
<b>Width</b>	<b>120 mm</b>	<b>145 mm</b>
<b>Main circuit</b>		
<b>Rated insulation voltage <math>U_i</math></b> (pollution degree 3)	V	1000
<b>Rated impulse withstand voltage <math>U_{imp}</math></b>	kV	8
<b>Rated operational voltage <math>U_e</math></b>	V	1000
<b>Type of current</b>	No	
• Direct current	Yes, 50/60 Hz $\pm$ 5 (other frequencies on request)	
• Alternating current		
<b>Set current</b>	A	50 ... 200
		55 ... 250 to 160 ... 630
<b>Power loss per unit (max.)</b>	W	0.05
<b>Short-circuit protection</b>	See Selection and Ordering Data	
- With fuse without contactor	See Technical Specifications (short-circuit protection with fuses for motor feeders)	
- With fuse and contactor		
<b>Safe isolation between main and auxiliary conducting path</b> according to IEC 60947-1	V	690 <sup>1)</sup>
<b>Connection for main circuit</b>		
<b>Electrical connection version</b>	Screw terminal with box terminal/ Bus connection / Straight-through transformer	Screw terminal with box terminal/ Bus connection
<b>Screw terminal</b>		
• Terminal screw	4 mm Allen screw	5 mm Allen screw
• Tightening torque	Nm 10 ... 12	20 ... 22
• Conductor cross-sections (min./max.), 1 or 2 conductors		
- Solid	mm <sup>2</sup> --	
- Finely stranded without end sleeve	mm <sup>2</sup> With 3RT19 55-4G box terminal: 2 $\times$ (1 $\times$ max. 50, 1 $\times$ max. 70), 1 $\times$ (10 ... 70) With 3RT19 56-4G box terminal: 2 $\times$ (1 $\times$ max. 95, 1 $\times$ max. 120), 1 $\times$ (10 ... 120)	2 $\times$ (50 ... 185), front clamping point only: 1 $\times$ (70 ... 240) rear clamping point only: 1 $\times$ (120 ... 185)
- Finely stranded with end sleeve	mm <sup>2</sup> With 3RT19 55-4G box terminal: 2 $\times$ (1 $\times$ max. 50, 1 $\times$ max. 70), 1 $\times$ (10 ... 70) With 3RT19 56-4G box terminal: 2 $\times$ (1 $\times$ max. 95, 1 $\times$ max. 120), 1 $\times$ (10 ... 120)	2 $\times$ (50 ... 185), front clamping point only: 1 $\times$ (70 ... 240) rear clamping point only: 1 $\times$ (120 ... 185)
- Stranded	mm <sup>2</sup> With 3RT19 55-4G box terminal: 2 $\times$ (max. 70), 1 $\times$ (16 ... 70) With 3RT19 56-4G box terminal: 2 $\times$ (max. 120), 1 $\times$ (16 ... 120)	2 $\times$ (70 ... 240), front clamping point only: 1 $\times$ (95 ... 300) rear clamping point only: 1 $\times$ (120 ... 240)
- AWG conductors, solid or stranded	AWG With 3RT19 55-4G box terminal: 2 $\times$ (max. 1/0), 1 $\times$ (6 ... 2/0) With 3RT19 56-4G box terminal: 2 $\times$ (max. 3/0), 1 $\times$ (6 ... 250 kcmil)	2 $\times$ (2/0 ... 500 kcmil), front clamping point only: 1 $\times$ (3/0 ... 600 kcmil) rear clamping point only: 1 $\times$ (250 kcmil ... 500 kcmil)
- Ribbon cable conductors (number $\times$ width $\times$ circumference)	mm With 3RT19 55-4G box terminal: 2 $\times$ (6 $\times$ 15.5 $\times$ 0.8), 1 $\times$ (3 $\times$ 9 $\times$ 0.8 ... 6 $\times$ 15.5 $\times$ 0.8) With 3RT19 56-4G box terminal: 2 $\times$ (10 $\times$ 15.5 $\times$ 0.8), 1 $\times$ (3 $\times$ 9 $\times$ 0.8 ... 10 $\times$ 15.5 $\times$ 0.8)	2 $\times$ (20 $\times$ 24 $\times$ 0.5), 1 $\times$ (6 $\times$ 9 $\times$ 0.8 ... 20 $\times$ 24 $\times$ 0.5)
<b>Busbar connections</b>		
• Terminal screw	M 8 $\times$ 25	M 10 $\times$ 30
• Tightening torque	Nm 10 ... 14	14 ... 24
• Conductor cross-section (min./max.)		
- Finely stranded with cable lug	mm <sup>2</sup> 16 ... 95 <sup>2)</sup>	50 ... 240 <sup>3)</sup>
- Stranded with cable lug	mm <sup>2</sup> 25 ... 120 <sup>2)</sup>	70 ... 240 <sup>3)</sup>
- AWG connections, solid or stranded, with cable lug	AWG 4 ... 250 kcmil	2/0 ... 500 kcmil
- With connecting bar (max. width)	mm 15	25
<b>Straight-through transformers</b>		
• Diameter of opening	mm 24.5	--
• Conductor cross-section (max.)		
- NYY	mm <sup>2</sup> 120	--
- H07RN-F	mm <sup>2</sup> 70	--

1) For grounded networks, otherwise 600 V.

2) When connecting cable lugs according to DIN 46235, use the 3RT19 56-4EA1 terminal cover for conductor cross-sections from 95 mm<sup>2</sup> to ensure phase spacing.3) When connecting cable lugs according to DIN 46234 for conductor cross-sections from 240 mm<sup>2</sup> as well as DIN 46235 for conductor cross-sections from 185 mm<sup>2</sup>, use the 3RT19 56-4EA1 terminal cover to ensure phase spacing.



Type	3RB30 16, 3RB31 13	3RB30 26, 3RB31 23	3RB30 36, 3RB31 33	3RB30 46, 3RB31 43	3RB30 56, 3RB31 53	3RB30 66, 3RB31 63
Size	S00	S0	S2	S3	S6	S10/S12
Width	45 mm	45 mm	55 mm	70 mm	120 mm	145 mm
<b>Auxiliary circuit</b>						
Number of NO contacts	1					
Number of NC contacts	1					
Auxiliary contacts – assignment	1 NO for the signal "tripped", 1 NC for switching off the contactor					
Rated insulation voltage $U_i$ (pollution degree 3)	V	300				
Rated impulse withstand voltage $U_{imp}$	kV	4				
<b>Auxiliary contacts – Contact rating</b>						
• NC contact with alternating current AC-14/AC-15 Rated operational current $I_e$ at $U_e$ :						
- 24 V	A	4				
- 120 V	A	4				
- 125 V	A	4				
- 250 V	A	3				
• NO contact with alternating current AC-14/AC-15: Rated operational current $I_e$ at $U_e$ :						
- 24 V	A	4				
- 120 V	A	4				
- 125 V	A	4				
- 250 V	A	3				
• NC, NO contact with direct current DC-13: Rated operational current $I_e$ at $U_e$ :						
- 24 V	A	1)				
- 60 V	A	0.55				
- 110 V	A	0.3				
- 125 V	A	0.3				
- 250 V	A	0.11				
• Continuous thermal current $I_{th}$	A	5				
• Contact reliability (suitability for PLC control; 17 V, 5 mA)		Yes				
<b>Short-circuit protection</b>						
• With fuse						
- gL/gG operational class	A	6				
<b>Ground-fault protection (only 3RB31)</b>						
• Tripping value $I_{\Delta}$						
• Operating range $I$						
• Response time $t_{trip}$ (in steady-state condition)						
	s	The information refers to sinusoidal residual currents at 50/60 Hz. > $0.75 \times I_{motor}$ Lower current setting value < $I_{motor}$ < $3.5 \times$ upper current setting value < 1				
<b>Integrated electrical remote RESET (only 3RB31)</b>						
Connecting terminals A3, A4						
		24 V DC, max. 200 mA for approx. 20 ms, then < 10 mA				
<b>Protective separation between main and auxiliary conducting path</b> according to IEC 60947-1						
	V	300				
<b>CSA, UL, and UR rated data</b>						
<b>Auxiliary circuit – switching capacity</b>						
3RB30: B600, R300				B300, R300		
3RB31: B300, R300						
<b>Connection of the auxiliary circuit</b>						
<b>Connection type</b>						
Screw terminal or spring-loaded terminals						
<b>Screw terminal</b>						
• Terminal screw						
• Tightening torque						
	Nm	Pozi driv size 2 0.8 ... 1.2				
• Conductor cross-sections (min./max.), 1 or 2 conductors						
- Solid or stranded	mm <sup>2</sup>	1 × (0.5 ... 4), 2 × (0.5 ... 2.5)				
- Finely stranded with end sleeve	mm <sup>2</sup>	1 × (0.5 ... 2.5), 2 × (0.5 ... 1.5)				
- AWG conductors, solid or stranded	AWG	2 × (20 ... 14)				
<b>Spring-loaded terminals</b>						
• Conductor cross-sections (min./max.), 1 or 2 conductors						
- Solid	mm <sup>2</sup>	2 × (0.25 ... 1.5)				
- Finely stranded without end sleeve	mm <sup>2</sup>	--				
- Finely stranded with end sleeve	mm <sup>2</sup>	2 × (0.25 ... 1.5)				
- Stranded	mm <sup>2</sup>	2 × (0.25 ... 1.5)				
- AWG conductors, solid or stranded	AWG	2 × (24 ... 16)				

# 3RB2 / 3RB3 Solid-State Overload Relays

3RB20, 3RB21, 3RB30, 3RB31 up to 630A for standard applications

## Short-circuit protection with fuses for motor starters

For short-circuit currents up to 50 kA at 400 to 690 V

Overload relays	Contactor	CLASS									690 V	
		5 and 10			20			30			Fuse links <sup>1)</sup>	Type of coordination <sup>2)</sup>
Setting range	Type	Rated operational current $I_e$ AC-3 in A at									1	2
		400 V	500 V	690 V	400 V	500 V	690 V	400 V	500 V	690 V		
<b>Size S00</b>												
0.1 ... 0.4 A	3RT20 15	0.4	0.4	0.4	0.4	0.4	0.4	0.4	0.4	0.4	35	4
0.32 ... 1.25 A	3RT20 15	1.25	1.25	1.25	1.25	1.25	1.25	1.25	1.25	1.25	35	6
1 ... 4 A	3RT20 15	4	4	4	4	4	4	4	4	4	35	20
	3RT20 16	4	4	4	4	4	4	4	4	4	35	20
	3RT20 17	4	4	4	4	4	4	4	4	4	35	20
4 ... 16 A	3RT20 16	9	6.5	5.2	9	6.5	5.2	9	6.5	5.2	35	20
	3RT20 17	12	9	6.3	10	9	6.3	9	9	6.3	35	20
	3RT20 18	16	12.4	8.9	12.9	11.6	8.1	11.6	11.6	8.1	50	25
<b>Size S0</b>												
3 ... 12 A	3RT20 23	9	6.5	5.2	9	6.5	5.2	--	--	--	63	25
	3RT20 24	12	12	9	12	12	9	12	12	9	63	25
	3RT20 25	12	12		12	12	12	12	12	12	63	25
10 ... 40	3RT20 24	12	12	9	12	12	9	12	12	9	63	25
	3RT20 25	17	17	13	16	16	13	14	14	13	63	25
	3RT20 26	25	18	13	16	16	13	14	14	13	100	35
	3RT20 27	32	32	21	18.6	18.6	15.1	16.2	16.2	15.1	125	50
	3RT20 28	38	32	21	22.4	22.4	18.2	19.6	19.6	18.2	125	50
<b>Size S2</b>												
12.5 ... 50 A	3RT20 35	40	40	24	40	40	24	36	36	36	160	80
	3RT20 36	50	50	24	45	45	24	38	38	24	160	80
	3RT20 37	50	50	47	48	48	47	42	42	42	250	125
	3RT20 38	50	50	50	49	49	49	43	43	43	250	160
20 ... 80 A	3RT20 35	40	40	24	40	40	24	36	36	36	160	80
	3RT20 36	50	50	24	45	45	24	38	38	24	160	80
	3RT20 37	65	65	47	48	48	47	42	42	42	250	125
	3RT20 38	80	80	58	49	49	49	43	43	43	250	160
<b>Size S3</b>												
12.5 ... 50 A	3RT20 45	50	50	47	49	49	47	41.7	41.7	41.7	200	125
	3RT20 46	50	50	50	50	50	50	45	45	45	200	160
32 ... 115 A	3RT20 45	65	65	47	49	49	47	41.7	41.7	41.7	200	125
	3RT20 46	80	80	58	53	53	53	45	45	45	200	160
	3RT20 47	95	95	58	59	59	58	50	50	50	200	160
	3RT10 54	100	100	100	81.7	81.7	81.7	69	69	69	355	315
	3RT10 55	--	--	--	100	100	100	90	90	90	355	315
<b>Size S6</b>												
50 ... 200 A	3RT10 54	115	115	115	81.7	81.7	81.7	69	69	69	355	315
	3RT10 55	150	150	150	107	107	107	90	90	90	355	315
	3RT10 56	185	185	170	131	131	131	111	111	111	355	315
<b>Size S10/S12</b>												
55 ... 250 A	3RT10 64	225	225	225	160	160	160	135	135	135	500	400
	3RT10 65	250	250	250	188	188	188	159	159	159	500	400
	3RT10 66	250	250	250	213	213	213	180	180	180	500	400
160 ... 630 A	3RT10 64	225	225	225	160	160	160	--	--	--	500	400
	3RT10 65	265	265	265	188	188	188	--	--	--	500	400
	3RT10 66	300	300	280	213	213	213	180	180	180	500	400
	3RT10 75	400	400	400	284	284	284	240	240	240	630	400
	3RT10 76	500	500	450	355	355	355	300	300	300	630	500
	3RT12 64	225	225	225	225	225	225	173	173	173	500	500
	3RT12 65	265	265	265	265	265	265	204	204	204	500	500
	3RT12 66	300	300	300	300	300	300	231	231	231	500	500
	3RT12 75	400	400	400	400	400	400	316	316	316	800	800
	3RT12 76	500	500	500	500	500	500	385	385	385	800	800
	3TF68 <sup>3)</sup>	630	630	630	440	440	440	376	376	376	800	500 <sup>4)</sup>
	3TF69 <sup>3)</sup>	630	630	630	572	572	572	500	500	500	800	630 <sup>4)</sup>

1) Please observe operational voltage.

2) Coordination and short-circuit equipment according to EN 60947-4-1:

**Type of coordination 1:** the contactor or starter must not endanger persons or the installation in the event of a short-circuit. They do not need to be suitable for further operation without repair and the renewal of parts.

**Type of coordination 2:** the contactor or starter must not endanger persons or the installation in the event of a short-circuit. They must be suitable for further operation. There is a risk of contact welding.

3) Contactor cannot be mounted.

4) Please ensure that the maximum AC-3 operational current has sufficient safety clearance from the rated current of the fuses.

# 3RB2 / 3RB3 Solid-State Overload Relays

3RB20, 3RB21, 3RB30, 3RB31 up to 630A for standard applications

## Characteristic curves

The tripping characteristics show the relationship between the tripping time and tripping current as multiples of the set current  $I_e$  and are given for symmetrical three-pole and two-pole loads from the cold state.

The smallest current used for tripping is called the minimum tripping current. According to IEC 60947-4-1, this current must be within specified limits. The limits of the total tripping current for the 3RB20/3RB21 solid-state overload relays for symmetrical three-pole loads are between 105 % and 120 % of the set current.

The tripping characteristic starts with the minimum tripping current and continues with higher tripping currents based on the characteristics of the so-called trip classes (CLASS 10, CLASS 20 etc.). The trip classes describe time intervals within which the overload relays have to trip with 7.2 times the set current  $I_e$  from the cold state for symmetrical three-pole loads.

The tripping times according to IEC 60947-4-1, tolerance band E, are as follows for:

Trip class	Tripping time
CLASS 5	3 ... 5 s
CLASS 10	5 ... 10 s
CLASS 20	10 ... 20 s
CLASS 30	20 ... 30 s

The tripping characteristic for a three-pole overload relay from the cold state (see illustration 1) only apply if all three phases are simultaneously loaded with the same current. In the event of a phase failure the 3RB20/3RB21 solid-state overload relays switch off the contactor more quickly in order to minimize heating of the load in accordance with the tripping characteristic for two-pole loads from the cold state (see illustration 2). With phase unbalance the devices switch off depending on the reason for the unbalance between the two characteristic curves.

Compared with a cold load, a load at operating temperature obviously has a lower temperature reserve. The tripping time of the 3RB2/3RB3 solid-state overload relays is reduced therefore to about 30 % when loaded with the set current  $I_e$  for an extended period.

Tripping characteristics for 3-pole loads

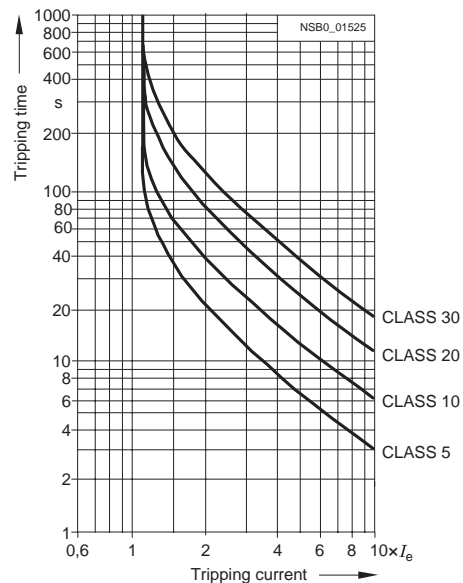

Illustration 1

Tripping characteristics for 2-pole loads

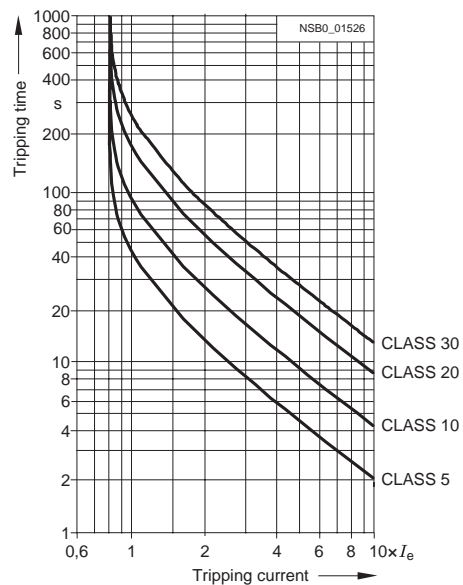

Illustration 2

The above illustrations are schematic representations of characteristic curves.



# 3RB2 / 3RB3 Solid-State Overload Relays

3RB20, 3RB21, 3RB30, 3RB31 up to 630A for standard applications

## Dimensional drawings

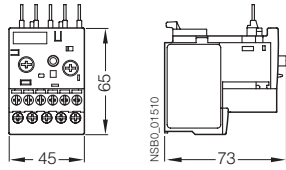

3RB30 16, 3RB31 13, size S00

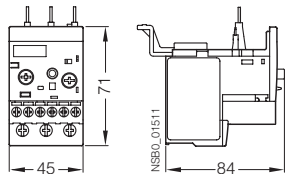

3RB30 26, 3RB31 23, size S0

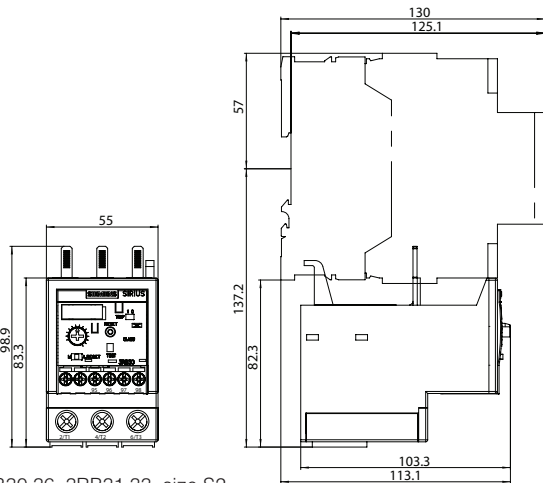

3RB30 36, 3RB31 33, size S2

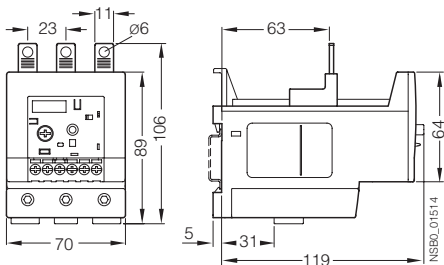

3RB30 46, 3RB31 43, size S3

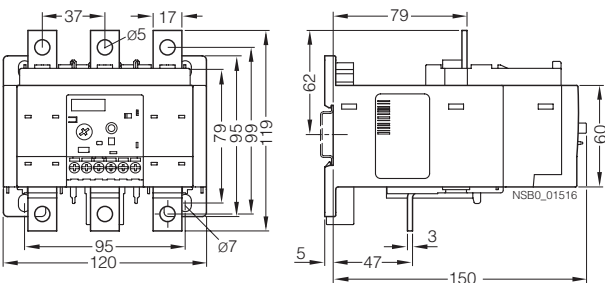

3RB20 56, 3RB21 53, size S6

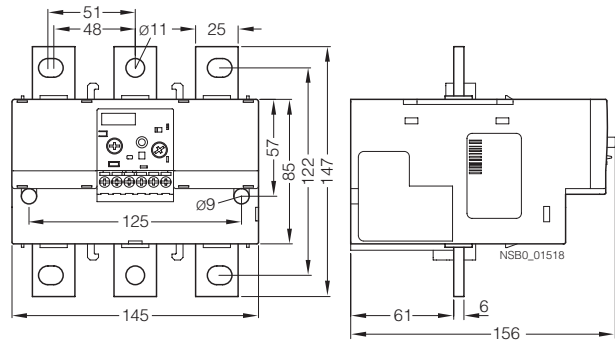

3RB20 66, 3RB21 63, size S10/S12

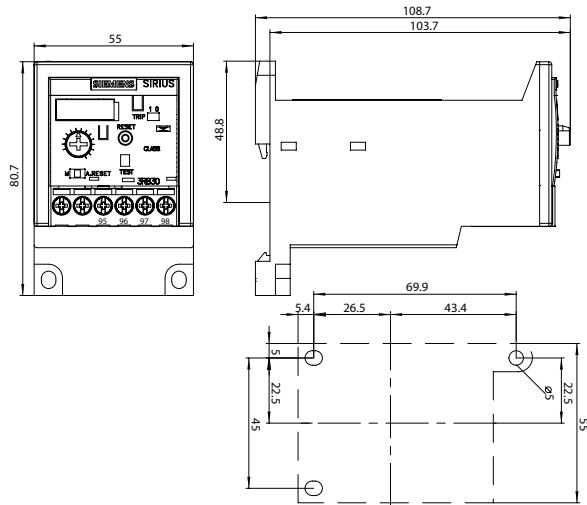

3RB30 36, 3RB31 33, size S2 with straight-through transformer

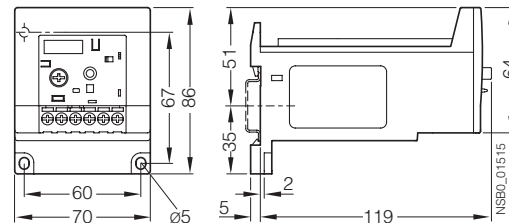

3RB30 46, 3RB31 43, size S3 with straight-through transformer

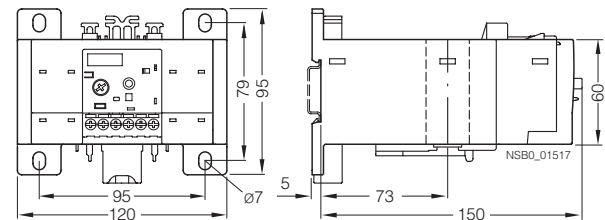

3RB20 56, 3RB21 53, size S6 with straight-through transformer

# 3RB2 / 3RB3 Solid-State Overload Relays

3RB20, 3RB21, 3RB30, 3RB31 up to 630A for standard applications

## Schematics

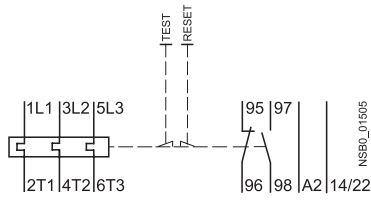

3RB30 16 overload relays

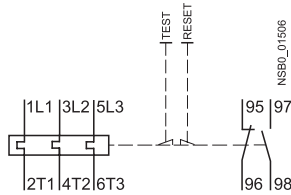

3RB30 26 to 3RB20 66 overload relays

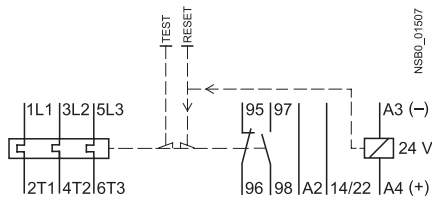

3RB31 13 overload relays

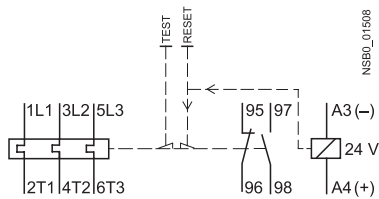

3RB31 23 to 3RB21 63 overload relays

# 3RB2 Solid-State Overload Relays

3RB22, 3RB23 for high-feature applications

## Overview

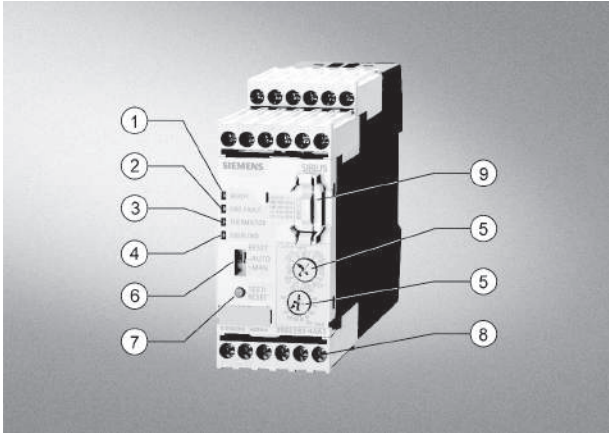

3RB22/3RB23 evaluation module

- (1) Green "Ready" LED:  
A continuous green light signals that the device is working correctly.
- (2) Red "Ground Fault" LED:  
A continuous red light signals a ground fault.
- (3) Red "Thermistor" LED:  
A continuous red light signals an active thermistor trip.
- (4) Red "Overload" LED:  
A continuous red light signals an active overload trip; a flickering red light signals an imminent trip (overload warning).
- (5) Motor current and trip class adjustment:  
Setting the device to the motor current and to the required trip class dependent on the starting conditions is easy with the two rotary knobs.
- (6) Selector switch for manual/automatic RESET:  
With this switch you can choose between manual and automatic RESET.
- (7) Test/RESET button:  
Enables testing of all important device components and functions, plus resetting of the device after a trip when manual RESET is selected.
- (8) Connecting terminals (removable terminal block):  
The generously sized terminals permit connection of two conductors with different cross-sections for the auxiliary, control and sensor circuits. Connection is possible with screw-type terminals and alternatively with spring-loaded terminals.
- (9) 3RB29 85 function expansion module:  
Enables more functions to be added, e.g. internal ground fault detection and/or an analog output with corresponding signals.

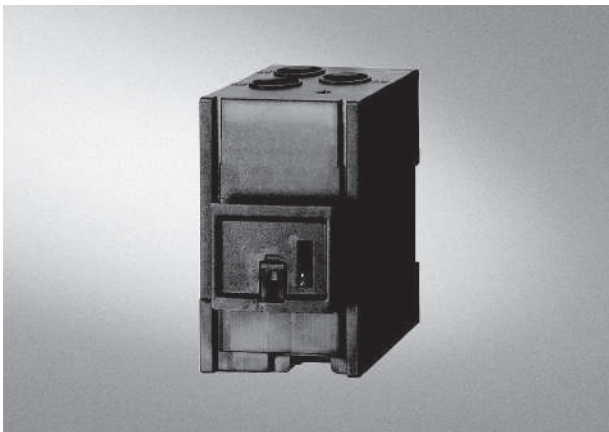

3RB29 06 current measuring module

The modular, solid-state overload relays with external power supply type 3RB22 (with monostable auxiliary contacts) and type 3RB23 (with bistable auxiliary contacts) up to 630 A (up to 820 A possible with a series transformer) have been designed for inverse-time delayed protection of loads with normal and heavy starting (see [Function](#)) against excessive temperature rises due to overload, phase unbalance or phase failure. An overload, phase unbalance or phase failure result in an increase of the motor current beyond the set motor rated current. This current rise is detected by means of a current measuring module and electronically evaluated by a special evaluation module which is connected to it. The evaluation electronics sends a signal to the auxiliary contacts. The auxiliary contacts then switch off the load by means of the contactors control circuit. The break time depends on the ratio between the tripping current and set current  $I_{\text{e}}$  and is stored in the form of a long-term stable tripping characteristic (see [Characteristic Curves](#)). The "tripped" status is signaled by means of a continuous red "Overload" LED.

The LED indicates imminent tripping of the relay due to overload, phase unbalance or phase failure by flickering when the limit current has been violated. This warning can also be used as a signal through auxiliary contacts.

In addition to the described inverse-time delayed protection of loads against excessive temperature rise, the 3RB22/3RB23 solid-state overload relays also allow direct temperature monitoring of the motor windings (full motor protection) by failsafe connection of a PTC sensor circuit. With this temperature-dependent protection, the loads can be protected against overheating caused indirectly by reduced coolant flow, for example, which cannot be detected by means of the current alone. In the event of overheating, the devices signal the contactor to switch off, and thus the load, by means of the auxiliary contacts. The "tripped" status is signaled by means of a continuous red "Thermistor" LED.

To also protect the loads against high-resistance short-circuits due to damage to the insulation, humidity, condensed water, etc., the 3RB22/3RB23 solid-state overload relays offer the possibility of internal ground fault monitoring in conjunction with a function expansion module; not possible in conjunction with a contactor assembly for Wye-Delta starting). In the event of a ground fault the 3RB22/3RB23 relays trip instantaneously. The "tripped" status is signaled by means of a red "Ground Fault" LED. Signaling through auxiliary contacts is also possible.

After tripping due to overload, phase unbalance, phase failure, thermistor tripping or ground fault, the relay may be reset manually or automatically after the recovery time has elapsed (see [Function](#)).

In conjunction with a function expansion module the motor current measured by the microprocessor can be output in the form of an analog signal 4 ... 20 mA DC for operating rotary coil instruments or for feeding into analog inputs of programmable logic controllers. With an additional AS-Interface analog module the current values can also be transferred over the AS-i bus system.

The devices are manufactured in accordance with environmental guidelines and contain environmentally friendly and reusable materials.

They comply with important worldwide standards and approvals.

# 3RB2 Solid-State Overload Relays

3RB22, 3RB23 for high-feature applications

## Benefits

The most important features and benefits of the 3RB22/3RB23 solid-state overload relays are listed in the overview table (see [Overload Relays, General Data](#)).

## Application

### Industries

The 3RB22/3RB23 solid-state overload relays are suitable for customers from all industries who want to provide optimum inverse-time delayed and temperature-dependent protection of their electrical loads (e.g. motors) under normal and heavy starting conditions (CLASS 5 to CLASS 30), minimize project completion times, inventories and power consumption, and optimize plant availability and maintenance management.

### Application

The 3RB22/3RB23 solid-state overload relays have been designed for the protection of three-phase asynchronous and single-phase AC motors.

If single-phase AC motors are to be protected by the 3RB22/3RB23 solid-state overload relays, the main circuits of the current measuring modules must be series-connected.

### Ambient conditions

The devices are insensitive to external influences such as shocks, corrosive environments, ageing and temperature changes.

For the temperature range from  $-25\text{ °C}$  to  $+60\text{ °C}$ , the 3RB22/3RB23 solid-state overload relays compensate the temperature according to IEC 60947-4-1.

Configuration notes for use of the devices below  $-25\text{ °C}$  or above  $+60\text{ °C}$  on request.

## "Increased safety" type of protection EEx e according to ATEX guideline 94/9/EC

The 3RB22/3RB23 solid-state overload relays are suitable for the overload protection of explosion-proof motors with "increased safety" type of protection EEx e. The relays meet the requirements of EN 60079-7 (Electrical apparatus for potentially explosive atmospheres – Increased safety "e").

When using 3RB23 solid-state overload relays for the protection of EEx e motors, separate monitoring of the control supply voltage is recommended.

The basic safety and health requirements of ATEX guideline 94/9/EG are fulfilled by compliance with

- EN 60947-1
- EN 60947-4-1
- EN 60947-5-1
- EN 60079-14

EU type test certificate for Group II, Category (2) G/D under application. Number on request.

## Accessories

The following accessories are available for the 3RB22/3RB23 solid-state overload relays:

- A sealable cover for the evaluation module
- Box terminal blocks for the current measuring modules size S6 and S10/S12
- Terminal covers for the current measuring modules size S6 and S10/S12
- Push-in lugs for screw (panel) mounting the size S00 to S3 current measuring modules

# 3RB2 Solid-State Overload Relays



3RB22, 3RB23 for high-feature applications

**3RB22/3RB23 solid-state overload relays for full motor protection with screw connection or spring-loaded terminals for stand-alone installation, CLASS 5, 10, 20 and 30 adjustable**

Features and technical specifications:

- Overload protection, phase failure protection and unbalance protection
- External power supply 24 ... 240 V AC/DC
- Auxiliary contacts 2 NO +2 NC
- Manual and automatic RESET
- Electrical remote RESET integrated
- 4 LEDs for operating and status displays
- TEST function and self-monitoring
- Internal ground fault detection with function expansion module
- Screw connection or spring-loaded terminals for auxiliary, control and sensor circuits
- Input for PTC sensor circuit
- Analog output with function expansion module

Size Contactor	Version	Connection type	Order No.	Weight per PU approx. kg
----------------	---------	-----------------	-----------	--------------------------

Evaluation modules				
	S00 ... S12	Monostable	Screw connection	<b>3RB22 83-4AA1</b> 0.300
			Spring-loaded terminals	<b>3RB22 83-4AC1</b> 0.300
		Bistable	Screw connection	<b>3RB23 83-4AA1</b> 0.300
			Spring-loaded terminals	<b>3RB23 83-4AC1</b> 0.300
				

Function expansion modules				
–		<b>Analog Basic 1 module<sup>1)</sup></b> Analog output DC 4 ... 20 mA, with overload warning		<b>3RB29 85-2AA0</b> 0.030
		<b>Analog Basic 1 GF module<sup>1)2)</sup></b> Analog output DC 4 ... 20 mA, with internal ground fault detection and overload warning		<b>3RB29 85-2AA1</b> 0.030
		<b>Analog Basic 2 GF module<sup>1)2)</sup></b> Analog output DC 4 ... 20 mA, with internal ground fault detection and ground fault signaling		<b>3RB29 85-2AB1</b> 0.030
		<b>Basic 1 GF module<sup>2)</sup></b> with internal ground fault detection and overload warning		<b>3RB29 85-2CA1</b> 0.030
		<b>Basic 2 GF module<sup>2)</sup></b> with internal ground fault detection and ground fault signaling		<b>3RB29 85-2CB1</b> 0.030

- 1) The analog signal 4 ... 20 mA DC can be used for operating rotary coil instruments or for feeding into analog inputs of programmable logic controllers.
- 2) The following information on ground fault protection refers to sinusoidal residual currents at 50/60 Hz:
  - With a motor current of between 0.3 and 2 times the set current  $I_n$  the unit will trip at a ground fault current equal to 30% of the set current.
  - With a motor current of between 2 and 8 times the set current  $I_n$  the unit will trip at a ground fault current equal to 15% of the set current.
  - The trip delay amounts to between 0.5 and 1 second.





*Note: Analog input modules, e. g. SM 331, must be configured for 4-wire measuring transducers. In this case the analog input module must not supply current to the analog output of the 3RB22/ 3RB23 relay.*

For accessories, see page 3/35  
 For description, see pages 3/32-3/33  
 For technical data, see pages 3/39-3/44.  
 For dimension drawings, see pages 3/45-3/46.  
 For schematic diagrams, see page 3/47.

# 3RB2 Solid-State Overload Relays

3RB22, 3RB23 for high-feature applications

## Current measuring modules for direct mounting<sup>1)</sup> and stand-alone installation<sup>1)2)</sup>

Size Con-factor <sup>3)</sup>	Set current value of the inverse-time delayed overload trip A	Order No.	Weight per PU approx. kg
<b>Size S00/S0<sup>2)4)</sup></b>			
 3RB29 06-2.G1	S00/S0	0.3 ... 3	<b>3RB29 06-2BG1</b> 0.100
		2.4 ... 25	<b>3RB29 06-2DG1</b> 0.150
<b>Size S2/S3<sup>2)4)</sup></b>			
 3RB29 06-2JG1	S2/S3	10 ... 100	<b>3RB29 06-2JG1</b> 0.350
<b>Size S6<sup>1)4)</sup></b>			
 3RB29 56-2TG2	S6	20 ... 200	<b>3RB29 56-2TG2</b> 0.600
		with pass through CT's with busbar	<b>3RB29 56-2TH2</b> 1.000
<b>Size S10/S12<sup>1)</sup></b>			
 3RB29 66-2WH2	S10/S12 and size 14 (3TF68/ 3TF69)	63 ... 630	<b>3RB29 66-2WH2</b> 1.750

- 1) The current measuring modules with an Order No. ending with "2" are designed for direct mounting and stand-alone installation. For 3TF68/3TF69 contactors, direct mounting is not possible.  
2) The current measuring modules with an Order No. ending with "1" are designed for stand-alone installation.

- 3) Observe maximum rated operational current of the devices.  
4) The modules with an Order No. with "G" in 11th position are equipped with a straight-through transformer.

Size Contactor	Version	Order No.	Weight per PU approx. kg
<b>Connecting cables (essential accessory)</b>			
 3RB29 87-2.	S00 ... S12	For connection between evaluation module and current measuring module	
		<ul style="list-style-type: none"> <li>Length 0.1 m</li> <li>Length 0.5 m</li> </ul>	<b>3RB29 87-2B</b> 0.010 <b>3RB29 87-2D</b> 0.020

For description, see pages 3/36-3/37.  
For technical data, see pages 3/39-3/44.  
For dimension drawings, see pages 3/45-3/46.  
For schematic diagrams, see page 3/47.

# 3RB2 Solid-State Overload Relays

3RB22, 3RB23 for high-feature applications

## Design

### Device concept

The 3RB22/3RB23 solid-state overload relays are based on a modular device concept. Each device always comprises an evaluation module, which is independent of the motor current, and a current measuring module, which is dependent on the motor current. The two modules are electrically interconnected by a connection cable through the system interface.

The basic functionality of the evaluation module can be optionally expanded with corresponding function expansion modules. The function expansion modules are integrated in the evaluation module for this purpose through a simple plug connection.

### Mounting options

#### Current measuring modules

The current measuring modules size S00/S0 and S2/S3 are designed for stand-alone installation. By contrast, the current measuring modules size S6 and S10/S12 are suitable for stand-alone installation or direct mounting.

#### Evaluation modules

The evaluation modules can be mounted either on the current measuring module (only sizes S00/S0 and S2/S3) or separately.

### Connection technique

#### Main circuit (current measuring module)

For sizes S00/S0, S2/S3 and S6, the main circuit can also be connected by the straight-through transformer method. In this case, the cables of the main circuit are routed directly through the feed-through openings of the relay to the contactor terminals.

For sizes S6 and S10/S12, the main circuit can be connected with the help of the Busbar. In conjunction with the corresponding box terminals, screw terminals are also available.

#### Auxiliary circuit (evaluation module)

Connection of the auxiliary circuit (removable terminal block) is possible with either screw terminals or spring-loaded terminals.

### Overload relays in contactor assemblies for Wye-Delta starting

When overload relays are used in combination with contactor assemblies for Wye-Delta starting it must be noted that only 0.58 times the motor current flows through the line contactor. An overload relay mounted onto the line contactor must be set to 0.58 times the motor current.

When 3RB22/3RB23 solid-state overload relays are used in combination with contactor assemblies for Wye-Delta starting, the function expansion modules for internal ground-fault detection must not be used.

### Operation with frequency converter

The 3RB22/3RB23 solid-state overload relays are suitable for frequencies of 50/60 Hz and the associated harmonics. This permits the 3RB22/3RB23 overload relays to be used on the incoming side of the frequency converter.

If motor protection is required on the outgoing side of the frequency converter, the 3RN thermistor motor protection devices or the 3RU11 thermal overload relays are available for this purpose.

## Function

### Basic functions

The 3RB22/3RB23 solid-state overload relays are designed for:

- Inverse-time delayed protection of loads from overloading
- Inverse-time delayed protection of loads from phase unbalance
- Inverse-time delayed protection of loads from phase failure
- Temperature-dependent protection of loads by connecting a PTC sensor circuit
- Protection of loads from high-resistance short-circuits (internal ground-fault detection; detection of fault currents > 30 % of the set current  $I_e$ )
- Output of an overload warning
- Output of an analog signal 4 to 20 mA DC as image of the flowing motor current

The basic functions of the evaluation modules in conjunction with function expansion modules are listed in the following table:

Evaluation module	Function expansion module	Basic functions
3RB22 83-4AA1 3RB22 83-4AC1 3RB23 83-4AA1 3RB23 83-4AC1	None	Inverse-time delayed protection, temperature-dependent protection, electrical remote RESET, overload warning
	3RB29 85-2CA1	Inverse-time delayed protection, temperature-dependent protection, internal ground-fault detection, electrical remote RESET, overload warning
	3RB29 85-2CB1	Inverse-time delayed protection, temperature-dependent protection, internal ground-fault detection, electrical remote RESET, ground fault signal
	3RB29 85-2AA0	Inverse-time delayed protection, temperature-dependent protection, electrical remote RESET, overload warning, analog output
	3RB29 85-2AA1	Inverse-time delayed protection, temperature-dependent protection, internal ground-fault detection, electrical remote RESET, overload warning, analog output
	3RB29 85-2AB1	Inverse-time delayed protection, temperature-dependent protection, internal ground-fault detection, electrical remote RESET, ground fault signal, analog output

### Control circuit

The 3RB22/3RB23 solid-state overload relays require an external power supply (24–240 V AC/DC), i.e. an additional supply voltage is necessary.

### Short-circuit protection

Fuses or motor starter protectors must be used for short-circuit protection. For assignments of the corresponding short-circuit protection devices to the 3RB22/3RB23 solid-state overload relays with/without contactor see [Technical Specifications and Selection and Ordering Data](#).

### Trip classes

The 3RB22/3RB23 solid-state overload relays are suitable for normal and heavy starting. The required trip class (CLASS 5, 10, 20 or 30) can be adjusted by means of a rotary knob depending on the current starting condition.

For details of the trip classes see [Characteristic Curves](#).



# 3RB2 Solid-State Overload Relays

## 3RB22, 3RB23 for high-feature applications

### Phase failure protection

The 3RB22/3RB23 solid-state overload relays are fitted with phase failure protection (see [Characteristic Curves](#)) in order to minimize temperature rises of the load during single-phase operation.

### Setting

The 3RB22/3RB23 solid-state overload relays are set to the motor rated current by means of two rotary knobs.

- The upper rotary knob (CLASS/ $I_{e\max}$ ) is divided into 4 ranges: 1 A, 10 A, 100 A and 1000 A. The zone must be selected which corresponds to the rated motor current and the current measuring module to be used with it. With the range selected the required trip class (CLASS 5, 10, 20 or 30) can be determined.
- The lower rotary knob with percent scale (10 % ... 100 %) is then used to set the rated motor current in percent of the range selected with the upper rotary button.

### Example

- Rating of induction motor = 45 kW (50 Hz, 400 V AC)
- Rated motor current = 80 A
- Required trip class = CLASS 20
- Selected transformer: 10 to 100 A

### Solution

- Step 1: Use the upper rotary knob (CLASS) to select the 100 A range
- Step 2: Within the 100 A range set the trip class CLASS 20
- Step 3: Set the lower rotary knob to 80 % (= 0.8) of 100 A  $\times$  0.8 = 80 A.

If the current which is set on the evaluation module does not correspond to the current range of the connected current transformer, an error will result.

### Manual and automatic reset

In the case of the 3RB22/3RB23 solid-state overload relays, a slide switch can be used to choose between automatic and manual resetting.

If manual reset is set, a reset can be carried out directly on the device after a trip by pressing the blue TEST/RESET button. A remote RESET can be carried out electrically by jumpering the terminals Y1 and Y2.

If the slide switch is set to automatic RESET, the relay is reset automatically.

The time between tripping and resetting is determined by the recovery time.

### Recovery time

With the 3RB22/3RB23 solid-state overload relays the recovery time after inverse-time delayed tripping is approx. 3 minutes regardless of the selected reset mode. The recovery time allows the load to cool down.

However, in the event of temperature-dependent tripping by means of a connected PTC thermistor sensor circuit, the device can only be manually or automatically reset once the winding temperature at the installation location of the PTC thermistor has fallen 5 Kelvin below its response temperature.

After a ground fault trip the 3RB22/3RB23 solid-state overload relay trips can be reset immediately without a recovery time.

### TEST function

The combined TEST/RESET button can be used to check whether the relay is working correctly. The test can be aborted at any time by letting go of the TEST/RESET button.

LEDs, the device configuration (this depends on which expansion module is plugged in) and the device hardware are tested while the button is kept pressed for 6 seconds. Simultaneously and for another 18 seconds a direct current proportional in size to the maximum phase of the main current is fed in at the terminals I(+) and I(-). By comparing the analog signal, which is to be measured, with the main current, the accuracy of the current measurement can be determined. In this case 4 mA corresponds to 0 % and 20 mA to 125 % of the set current. After 24 seconds the auxiliary contacts are switched and the feeder switch off as the result, bringing the test to an end.

After a test trip a faultless relay is reset by pressing the TEST/RESET button. If a hardware fault is detected, the device trips and cannot be reset.

### Self-monitoring

The 3RB22/3RB23 solid-state overload relays have a self-monitoring feature, i.e. the devices constantly monitor their own basic functions and trip if an internal fault is detected.

### Display of the operating status

The particular operating status of the 3RB22/3RB23 solid-state overload relays is displayed by means of four LEDs:

- Green "Ready" LED: A continuous green light signals that the overload relay is ready for operation. The 3RB22/3RB23 overload relays are not ready (LED "OFF") if there is no control supply voltage or if the function test was negative.
- Red "Ground fault" LED: A continuous red light signals a ground fault.
- Red "Thermistor" LED: A continuous red light signals a temperature-dependent trip.
- Red "Overload" LED: A continuous red light signals an inverse-time delayed trip; a flickering red light signals an imminent inverse-time delayed trip (overload warning).

### Auxiliary contacts

The 3RB22/3RB23 solid-state overload relays have two outputs, each with one NO contact and one NC contact. Their basic assignment/function may be influenced by function expansion modules.

The 3RB22 and 3RB23 differ with respect to the tripping characteristics of their auxiliary contacts – monostable or bistable:

The monostable 3RB22 solid-state overload relays will enter the "tripped" state if the control supply voltage fails (> 200 ms), and return to the original state they were in before the control supply voltage failed when the voltage returns. These devices are therefore especially suited for plants in which the control voltage is not strictly monitored.

The bistable 3RB23 overload relays do not change their "tripped" or "not tripped" status if the control voltage fails. The auxiliary contacts only switch over in the event of an overload and if the supply voltage is present. These devices are therefore especially suited for plants in which the control voltage is monitored separately.

### Response if the control supply voltage fails

If the control supply voltage fails for more than 0.2 s, the output relays respond differently depending on the version: Monostable or bistable.

# 3RB2 Solid-State Overload Relays

3RB22, 3RB23 for high-feature applications

Response of the output relays in the event of	Monostable 3RB22	Bistable 3RB23
Failure of the control supply voltage	The device trips	No change of the switching status of the auxiliary contacts
Return of the control supply voltage without previous tripping	The device resets	No change of the switching status of the auxiliary contacts
Return of the control supply voltage after previous tripping	The device remains tripped Reset: <ul style="list-style-type: none"> <li>• For overload tripping, after 3 minutes</li> <li>• For thermistor tripping, after the temperature has fallen 5 K below the response temperature</li> <li>• For ground-fault tripping, immediately</li> </ul>	The device remains tripped Reset: <ul style="list-style-type: none"> <li>• For overload tripping, after 3 minutes</li> <li>• For thermistor tripping, after the temperature has fallen 5 K below the response temperature</li> <li>• For ground-fault tripping, immediately</li> </ul>

Monostable and bistable responses of the output relays

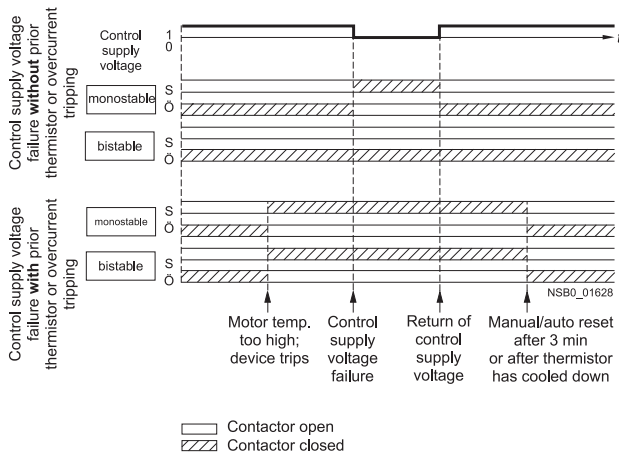

# 3RB2 Solid-State Overload Relays

3RB22, 3RB23 for standard applications



## Technical specifications

The following technical information is intended to provide an initial overview of the various types of device and functions.

Detailed information, see

- Reference Manual "Protection Equipment – 3RU1, 3RB2 Overload Relays", <http://support.automation.siemens.com/WWW/view/en/35681297>

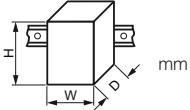
- or specific information on a particular article number via the product data sheet, <http://support.automation.siemens.com/WWW/view/en/20357046/133200>

Type – Overload relay: evaluation modules		3RB2283-4A.1	3RB2383-4A.1
Size contactor		S00 ... S10/S12	
Dimensions of evaluation modules (W x H x D)		45 x 111 x 95	
<b>General data</b>			
<b>Trips in the event of</b>		Overload, phase failure and phase unbalance (> 40 % according to NEMA), + ground fault (with corresponding function expansion module) and activation of the thermistor motor protection (with closed PTC sensor circuit)	
<b>Trip class</b> acc. to IEC 60947-4-1	CLASS	5, 10, 20 and 30 adjustable	
<b>Phase failure sensitivity</b>		Yes	
<b>Overload warning</b>		Yes, from $1.125 \times I_e$ for symmetrical loads and from $0.85 \times I_e$ for unsymmetrical loads	
<b>Reset and recovery</b>		Manual, automatic and remote RESET	
• Reset options after tripping			
• Recovery time			
- For automatic RESET	min.	- for tripping due to overcurrent: 3 (stored permanently) - for tripping by thermistor: time until the motor temperature has fallen 5 K below the response temperature	
- For manual RESET	min.	- for tripping due to a ground fault: no automatic RESET - for tripping due to overcurrent: 3 (stored permanently) - for tripping by thermistor: time until the motor temperature has fallen 5 K below the response temperature	
- For remote RESET	min.	- for tripping due to a ground fault: Immediately - for tripping due to overcurrent: 3 (stored permanently) - for tripping by thermistor: time until the motor temperature has fallen 5 K below the response temperature	
- For remote RESET	min.	- for tripping due to a ground fault: Immediately	
<b>Features</b>			
• Display of operating state on device		Yes, with four LEDs: - green LED "Ready" - red LED "Ground Fault" - red LED "Thermistor" - red LED "Overload"	
• TEST function		Yes, test of LEDs, electronics, auxiliary contacts and wiring of control circuit by pressing the button TEST/RESET / self-monitoring	
• RESET button		Yes, with the TEST/RESET button	
• STOP button		No	
<b>Protection and operation of explosion-proof motors</b>			
EC type test certificate number according to directive 94/9/EC (ATEX)		PTB 05 ATEX 3022  II (2) GD, see <a href="http://support.automation.siemens.com/WWW/view/en/23115758">http://support.automation.siemens.com/WWW/view/en/23115758</a>	--
<b>Ambient temperatures</b>			
• Storage/transport	°C	-40 ... +80	
• Operation	°C	-25 ... +60	
• Temperature compensation	°C	+60	
• Permissible rated current			
- Temperature inside control cabinet 60 °C	%	100	
- Temperature inside control cabinet 70 °C	%	On request	
<b>Degree of protection</b> acc. to IEC 60529		IP20: Current measuring modules in sizes S6 and S10/S12 with busbar connection in conjunction with cover.	
<b>Touch protection</b> acc. to IEC 61140		Finger-safe: Current measuring modules in sizes S6 and S10/S12 with busbar connection in conjunction with cover.	
<b>Shock resistance with sine</b> acc. to IEC 60068-2-27		g/ms	15/11
<b>Electromagnetic compatibility (EMC) – Interference immunity</b>			
• Conductor-related interference			
- Burst acc. to IEC 61000-4-4 (corresponds to degree of severity 3)	kV	2 (power ports), 1 (signal port)	
- Surge acc. to IEC 61000-4-5 (corresponds to degree of severity 3)	kV	2 (line to earth), 1 (line to line)	
• Electrostatic discharge according to IEC 61000-4-2 (corresponds to degree of severity 3)	kV	8 (air discharge), 6 (contact discharge)	
• Field-related interference according to IEC 61000-4-3 (corresponds to degree of severity 3)	V/m	10	
<b>Electromagnetic compatibility (EMC) – emitted interference</b>		Degree of severity A according to EN 55011 (CISPR 11) and EN 55022 (CISPR 22)	

# 3RB2 Solid-State Overload Relays

3RB22, 3RB23 for standard applications

Type – Overload relay of current measuring module	3RB29	3RB29	3RB29	3RB29
Size	S00/S0	S2/S3	S6	S10/S12
Width	45 mm	55 mm	120 mm	145 mm
<b>Main circuit</b>				
Rated insulation voltage $U_i$ (pollution degree 3)	V	1000	1000	
Rated impulse withstand voltage $U_{imp}$	kV	6	8	
Rated operational voltage $U_e$	V	690	1000	
Type of current		No		
• Direct current		Yes, 50/60 Hz $\pm$ 5 % (other frequencies on request)		
• Alternating current				
Set current	A	0.3 ... 3; 2.4 ... 25	10 ... 100	20 ... 200 63 ... 630
Power loss per unit (max.)	W	0.5		
Short-circuit protection		See Selection and Ordering Data		
• With fuse without contactor		See Technical Specifications (short-circuit protection with fuses for motor feeders)		
• With fuse and contactor				
Safe isolation between main and auxiliary conducting path according to IEC 60947-1	V	690 <sup>1)</sup>		
<b>Connection for main circuit</b>				
Electrical connection version		Screw terminals with box terminal		
<b>Screw terminal</b>				
• Terminal screw	--		4 mm Allen screw	5 mm Allen screw
• Tightening torque	--		10 ... 12	20 ... 22
• Conductor cross-sections (min./max.), 1 or 2 conductors				
- Solid	mm <sup>2</sup>	--	--	--
- Finely stranded without end sleeve	mm <sup>2</sup>	--	With 3RT19 55-4G box terminal: 2 x (1 x max. 50, 1 x max. 70), 1 x (10 ... 70)	2 x (50 ... 185), front clamping point only: 1 x (70 ... 240)
			With 3RT19 56-4G box terminal: 2 x (1 x max. 95, 1 x max. 120), 1 x (10 ... 120)	rear clamping point only: 1 x (120 ... 185)
- Finely stranded with end sleeve	mm <sup>2</sup>	--	With 3RT19 55-4G box terminal: 2 x (1 x max. 50, 1 x max. 70), 1 x (10 ... 70)	2 x (50 ... 185), front clamping point only: 1 x (70 ... 240)
			With 3RT19 56-4G box terminal: 2 x (1 x max. 95, 1 x max. 120), 1 x (10 ... 120)	rear clamping point only: 1 x (120 ... 185)
- Stranded	mm <sup>2</sup>	--	With 3RT19 55-4G box terminal: 2 x (max. 70), 1 x (16 ... 70)	2 x (70 ... 240), front clamping point only: 1 x (95 ... 300)
			With 3RT19 56-4G box terminal: 2 x (max. 120), 1 x (16 ... 120)	rear clamping point only: 1 x (120 ... 240)
- AWG conductors, solid or stranded	AWG	--	With 3RT19 55-4G box terminal: 2 x (max. 1/0), 1 x (6 ... 2/0)	2 x (2/0 ... 500 kcmil), front clamping point only: 1 x (3/0 ... 600 kcmil)
			With 3RT19 56-4G box terminal: 2 x (max. 3/0), 1 x (6 ... 250 kcmil)	rear clamping point only: 1 x (250 kcmil ... 500 kcmil)
- Ribbon cable conductors (number x width x circumference)	mm	--	With 3RT19 55-4G box terminal: 2 x (6 x 15.5 x 0.8), 1 x (3 x 9 x 0.8 ... 6 x 15.5 x 0.8)	2 x (20 x 24 x 0.5), 1 x (6 x 9 x 0.8 ... 20 x 24 x 0.5)
			With 3RT19 56-4G box terminal: 2 x (10 x 15.5 x 0.8), 1 x (3 x 9 x 0.8 ... 10 x 15.5 x 0.8)	
<b>Busbar connections</b>				
• Terminal screw	Nm	--	M8 x 25	M10 x 30
• Tightening torque	--	--	10 ... 14	14 ... 24
• Conductor cross-section (min./max.)				
- Solid with cable lug	mm <sup>2</sup>	--	16 ... 95 <sup>2)</sup>	50 ... 240 <sup>3)</sup>
- Stranded with cable lug	mm <sup>2</sup>	--	25 ... 120 <sup>2)</sup>	70 ... 240 <sup>3)</sup>
- AWG connections, solid or stranded, with cable lug	AWG	--	4 ... 250 kcmil	2/0 ... 500 kcmil
- With connecting bar (max. width)	mm	--	15	25
<b>Straight-through transformers</b>				
• Diameter of opening	mm	7.5	14	25
• Conductor cross-section (max.)				
- NYY	mm <sup>2</sup>	4)	4)	120
- H07RN-F	mm <sup>2</sup>	4)	4)	70

1) For grounded networks, otherwise 600 V.

2) When connecting cable lugs according to DIN 46235, use the 3RT19 56-4EA1 terminal cover for conductor cross-sections from 95 mm<sup>2</sup> to ensure phase spacing.

3) When connecting cable lugs according to DIN 46234 for conductor cross-sections from 240 mm<sup>2</sup> as well as DIN 46235 for conductor cross-sections from 185 mm<sup>2</sup>, use the 3RT19 56-4EA1 terminal cover to ensure phase spacing.

4) On request.

# 3RB2 Solid-State Overload Relays

3RB22, 3RB23 for standard applications

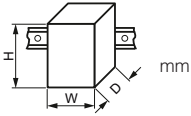

<b>Type – Overload relay: evaluation modules</b>		<b>3RB2283-4A.1</b>	<b>3RB2383-4A.1</b>
Size contactor		S00 ... S10/S12	
Dimensions of evaluation modules (W x H x D)		45 x 111 x 95	
<b>General data (continued)</b>			
<b>Resistance to extreme climates – air humidity</b>	%	100	
<b>Dimensions</b>		"Dimensional drawings", see <ul style="list-style-type: none"> <li>• Reference Manual "Protection Equipment – 3RU1, 3RB2 Overload Relays", <a href="http://support.automation.siemens.com/WW/view/en/35681297">http://support.automation.siemens.com/WW/view/en/35681297</a></li> <li>• Product data sheet, <a href="http://support.automation.siemens.com/WW/view/en/20357046/133200">http://support.automation.siemens.com/WW/view/en/20357046/133200</a></li> </ul>	
<b>Installation altitude above sea level</b>	m	Up to 2 000	
<b>Mounting position</b>		Any	
<b>Type of mounting</b>		Stand-alone installation	
• Evaluation modules		Stand-alone installation	
• Current measuring module	Size	S00 to S3: Stand-alone installation, S6 and S10/S12: stand-alone installation or mounting onto contactors	

<b>Type – Overload relay: evaluation modules</b>		<b>3RB2283-4A.1, 3RB2383-4A.1</b>	
Size contactor		S00 ... S10/S12	
<b>Auxiliary circuit</b>			
<b>Number of NO contacts</b>		2	
<b>Number of NC contacts</b>		2	
<b>Number of CO contacts</b>		--	
<b>Auxiliary contacts – assignment</b>		<ul style="list-style-type: none"> <li>• Alternative 1 <ul style="list-style-type: none"> <li>- 1 NO for the signal "tripped by overload and/or thermistor"</li> <li>- 1 NC for disconnecting the contactor</li> <li>- 1 NO for the signal "tripped by ground fault"</li> <li>- 1 NC for disconnecting the contactor</li> </ul> </li> <li>or<sup>1)</sup></li> <li>• Alternative 2 <ul style="list-style-type: none"> <li>- 1 NO for the signal "tripped by overload and/or thermistor and/or ground fault"</li> <li>- 1 NC for disconnecting the contactor</li> <li>- 1 NO for overload warning</li> <li>- 1 NC for disconnecting the contactor</li> </ul> </li> </ul>	
<b>Rated insulation voltage <math>U_i</math></b> (pollution degree 3)	V	300	
<b>Rated impulse withstand voltage <math>U_{imp}</math></b>	kV	4	
<b>Auxiliary contacts – contact rating</b>			
• NC contact with alternating current AC-14/AC-15, rated operational current $I_e$ at $U_e$			
- 24 V	A	6	
- 120 V	A	6	
- 125 V	A	6	
- 250 V	A	3	
• NO contact with alternating current AC-14/AC-15, rated operational current $I_e$ at $U_e$			
- 24 V	A	6	
- 120 V	A	6	
- 125 V	A	6	
- 250 V	A	3	
• NC contact, NO contact with direct current DC-13, rated operational current $I_e$ at $U_e$			
- 24 V	A	2	
- 60 V	A	0.55	
- 110 V	A	0.3	
- 125 V	A	0.3	
- 250 V	A	0.2	
• Conventional thermal current $I_{th}$	A	5	
• Contact reliability (suitability for PLC control; 17 V, 5 mA)		Yes	
<b>Short-circuit protection</b>			
• With fuse, operational class gG	A	6	
• With miniature circuit breaker, C characteristic	A	1.6	
<b>Protective separation between auxiliary current paths</b> acc. to IEC 60947-1	V	300	
<b>CSA, UL, UR rated data</b>			
<b>Auxiliary circuit – switching capacity</b>		B300, R300	

<sup>1)</sup> The assignment of auxiliary contacts may be influenced by function expansion modules.

# 3RB2 Solid-State Overload Relays

3RB22, 3RB23 for standard applications

<b>Type – Overload relay: evaluation modules</b>		<b>3RB2283-4A.1, 3RB2383-4A.1</b>	
Size contactor		S00 ... S10/S12	
<b>Control circuit</b>			
<b>Rated insulation voltage <math>U_i</math></b> (pollution degree 3)	V	300	
<b>Rated impulse withstand voltage <math>U_{imp}</math></b>	kV	4	
<b>Rated control supply voltage <math>U_s</math></b>			
• 50/60 Hz AC	V	24 ... 240	
• DC	V	24 ... 240	
<b>Operating range</b>			
• 50/60 Hz AC		$0.85 \times U_{s \min} \leq U_s \leq 1.1 \times U_{s \max}$	
• DC		$0.85 \times U_{s \min} \leq U_s \leq 1.1 \times U_{s \max}$	
<b>Rated power</b>			
• 50/60 Hz AC	W	0.5	
• DC	W	0.5	
<b>Mains buffering time</b>	ms	200	
<b>Sensor circuit</b>			
<b>Thermistor motor protection (PTC thermistor sensor)</b>			
• Summation cold resistance	k $\Omega$	$\leq 1.5$	
• Response value	k $\Omega$	3.4 ... 3.8	
• Return value	k $\Omega$	1.5 ... 1.65	
<b>Ground-fault detection</b>			
The information refers to sinusoidal residual currents at 50/60 Hz.			
• Tripping value $I_A^{(1)}$			
- For $0.3 \times I_e < I_{motor} < 2.0 \times I_e$		$> 0.3 \times I_e$	
- For $2.0 \times I_e < I_{motor} < 8.0 \times I_e$		$> 0.15 \times I_{motor}$	
• Response time $t_{trip}$	ms	500 ... 1 000	
<b>Analog output<sup>1)2)</sup></b>			
<b>Rated values</b>			
• Output signal	mA	4 ... 20	
• Measuring range		0 ... $1.25 \times I_e$ 4 mA corresponds to $0 \times I_e$ 16.8 mA corresponds to $1.0 \times I_e$ 20 mA corresponds to $1.25 \times I_e$	
• Load, max.	$\Omega$	100	
<b>Conductor cross-sections for the auxiliary, control and sensor circuit as well as the analog output</b>			
<b>Connection type</b>		 <b>Screw terminals</b>	
<b>Terminal screw</b>		M3, Pozidriv size 2	
<b>Operating devices</b>	mm	3.0 x 0.5	
<b>Prescribed tightening torque</b>	Nm	0.8 ... 1.2	
<b>Conductor cross-sections (min./max.),</b> 1 or 2 conductors can be connected			
• Solid or stranded	mm <sup>2</sup>	$1 \times (0.5 \dots 4)^3, 2 \times (0.5 \dots 2.5)^3$	
• Finely stranded without end sleeve	mm <sup>2</sup>	--	
• Finely stranded with end sleeve (DIN 46228-1)	mm <sup>2</sup>	$1 \times (0.5 \dots 2.5)^3, 2 \times (0.5 \dots 1.5)^3$	
• AWG cables, solid or stranded	AWG	2 x (20 ... 14)	
<b>Connection type</b>		 <b>Spring-type terminals</b>	
<b>Operating devices</b>	mm	3.0 x 0.5	
<b>Conductor cross-sections (min./max.),</b> 1 or 2 conductors can be connected			
• Solid or stranded	mm <sup>2</sup>	2 x (0.25 ... 1.5)	
• Finely stranded without end sleeve	mm <sup>2</sup>	--	
• Finely stranded with end sleeve (DIN 46228-1)	mm <sup>2</sup>	2 x (0.25 ... 1.5)	
• AWG cables, solid or stranded	AWG	2 x (24 ... 16)	

1) For the 3RB22 and 3RB23 overload relays in combination with a corresponding function expansion module.

2) Analog input modules, e.g. SM 331, must be configured for 4-wire measuring transducers. In this case the analog input module must not supply current to the analog output of the 3RB22 and 3RB23 relay.

3) If two different conductor cross-sections are connected to one clamping point, both cross-sections must be in the range specified.

# 3RB2 Solid-State Overload Relays

3RB22, 3RB23 for standard applications

## Short-circuit protection with fuses for motor feeders

For short-circuit currents up to 50 kA at 400 to 690 V

Overload relays	Contactor	CLASS									690 V		
		5 and 10			20			30			Fuse links <sup>1)</sup>		
Setting range	Type	Rated operational current $I_e$ AC-3 in A at									Type of coordination <sup>2)</sup>		
		400 V	500 V	690 V	400 V	500 V	690 V	400 V	500 V	690 V	1	2	
<b>Size S00/S0</b>													
0.3 ... 3 A	3RT20 15	3	3	3	3	3	3	3	3	3	3	35	20
	3RT20 16	3	3	3	3	3	3	3	3	3	3	35	20
2.4 ... 25 A	3RT20 15	7	5	4	7	5	4	7	5	4	35	20	
	3RT20 16	9	6.5	5.2	9	6.5	5.2	9	6.5	5.2	35	20	
	3RT20 17	12	9	6.3	10	9	6.3	9	9	6.3	35	20	
	3RT20 23	9	6.5	5.2	9	6.5	5.2	--	--	--	63	25	
	3RT20 24	12	12	9	12	12	9	12	12	9	63	25	
	3RT20 25	17	17	13	16	16	13	14	14	13	63	25	
	3RT20 26	25	18	13	16	16	13	14	14	13	100	35	
<b>Size S2/S3</b>													
On request	3RT20 35	On request											
	3RT20 36	On request											
	3RT20 45	On request											
	3RT20 46	On request											
	3RT20 47	On request											
<b>Size S6</b>													
20 ... 200 A	3RT10 54	115	115	115	81.7	81.7	81.7	69	69	69	355	315	
	3RT10 55	150	150	150	107	107	107	90	90	90	355	315	
	3RT10 56	185	185	170	131	131	131	111	111	111	355	315	
<b>Size S10/S12</b>													
160 ... 630 A	3RT10 64	225	225	225	160	160	160	135	135	135	500	400	
	3RT10 65	265	265	265	188	188	188	159	159	159	500	400	
	3RT10 66	300	300	280	213	213	213	180	180	180	500	400	
	3RT10 75	400	400	400	284	284	284	240	240	240	630	400	
	3RT10 76	500	500	450	355	355	355	300	300	300	630	500	
	3RT12 64	225	225	225	225	225	225	173	173	173	500	500	
	3RT12 65	265	265	265	265	265	265	204	204	204	500	500	
	3RT12 66	300	300	300	300	300	300	231	231	231	500	500	
	3RT12 75	400	400	400	400	400	400	316	316	316	800	800	
	3RT12 76	500	500	500	500	500	500	385	385	385	800	800	
	3TF68 <sup>3)</sup>	630	630	630	440	440	440	376	376	376	800	500 <sup>4)</sup>	
	3TF69 <sup>3)</sup>	630	630	630	572	572	572	500	500	500	800	630 <sup>4)</sup>	

- 1) Please observe operational voltage.
- 2) Coordination and short-circuit equipment according to EN 60947-4-1:  
**Type of coordination 1:** the contactor or starter must not endanger persons or the installation in the event of a short-circuit.  
 They do not need to be suitable for further operation without repair and the renewal of parts.  
**Type of coordination 2:** the contactor or starter must not endanger persons or the installation in the event of a short-circuit.  
 They must be suitable for further operation.  
 There is a risk of contact welding.
- 3) Contactor cannot be mounted.
- 4) Please ensure that the maximum AC-3 operational current has sufficient safety clearance from the rated current of the fuses.



# 3RB2 Solid-State Overload Relays

3RB22, 3RB23 for standard applications

## Characteristic curves

The tripping characteristics show the relationship between the tripping time and tripping current as multiples of the set current  $I_e$  and are given for symmetrical three-pole and two-pole loads from the cold state.

The smallest current used for tripping is called the minimum tripping current. According to IEC 60947-4-1, this current must be within specified limits. The limits of the minimum tripping current for the 3RB22/3RB23 solid-state overload relays for symmetrical three-pole loads are between 105 % and 120 % of the set current.

The tripping characteristic starts with the minimum tripping current and continues with higher tripping currents based on the characteristics of the so-called trip classes (CLASS 10, CLASS 20 etc.). The trip classes describe time intervals within which the overload relays have to trip with 7.2 times the set current  $I_e$  from the cold state for symmetrical three-pole loads.

The tripping times according to IEC 60947-4-1, tolerance band E, are as follows for:

Trip class	Tripping time
CLASS 5	3 ... 5 s
CLASS 10	5 ... 10 s
CLASS 20	10 ... 20 s
CLASS 30	20 ... 30 s

The tripping characteristic for a three-pole overload relay from the cold state (see illustration 1) only apply if all three phases are simultaneously loaded with the same current. In the event of a phase failure or a current unbalance of more than 40 %, the 3RB22/3RB23 solid-state overload relays switch off the contactor more quickly in order to minimize heating of the load in accordance with the tripping characteristic for two-pole loads from the cold state (see illustration 2).

Compared with a cold load, a load at operating temperature obviously has a lower temperature reserve. The tripping time of the 3RB22/3RB23 solid-state overload relays are reduced therefore to about 30 % when loaded with the set current  $I_e$  for an extended period.

Tripping characteristics for 3-pole loads

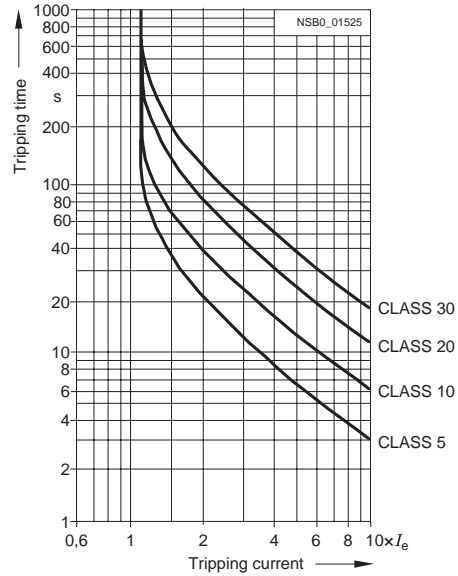

Illustration 1

Tripping characteristics for 2-pole loads

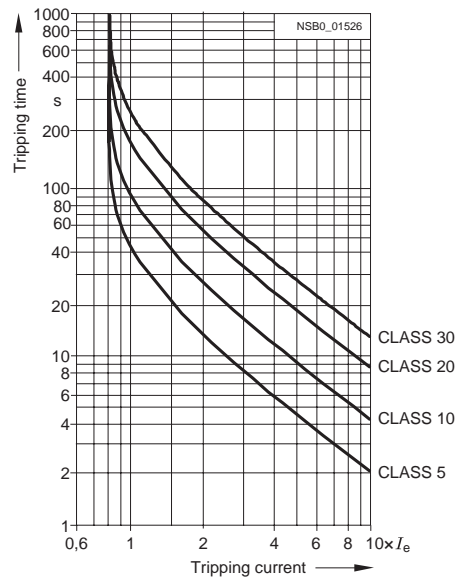

Illustration 2

The above illustrations are schematic representations of characteristic curves. The characteristic curves of the individual 3RB22/3RB23 solid-state overload relays can be requested from Technical Assistance at the following e-mail address:

[Technical-assistance@siemens.com](mailto:Technical-assistance@siemens.com)

# 3RB2 Solid-State Overload Relays

3RB22, 3RB23 for standard applications

## Dimensional drawings

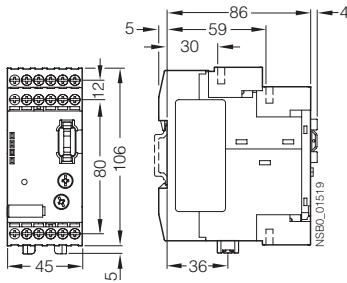

3RB22 83-4, 3RB23 83-4 evaluation module

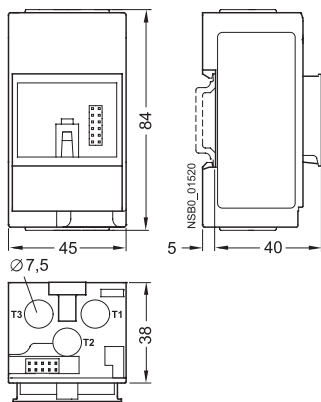

3RB29 06-2BG1, 3RB29 06-2DG1 current measuring module

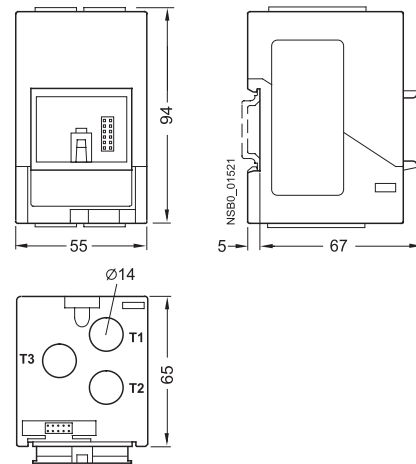

3RB29 06-2JG1 current measuring module

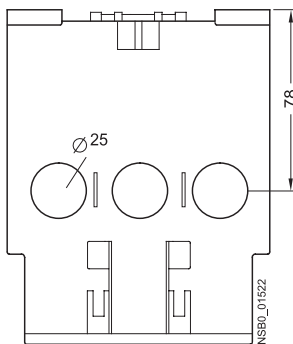
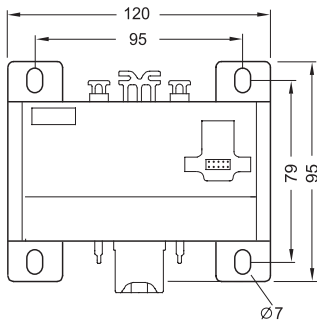

3RB29 56-2TG2 current measuring module

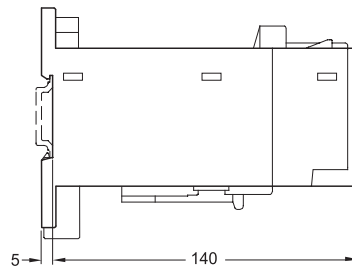

# 3RB2 Solid-State Overload Relays

3RB22, 3RB23 for standard applications

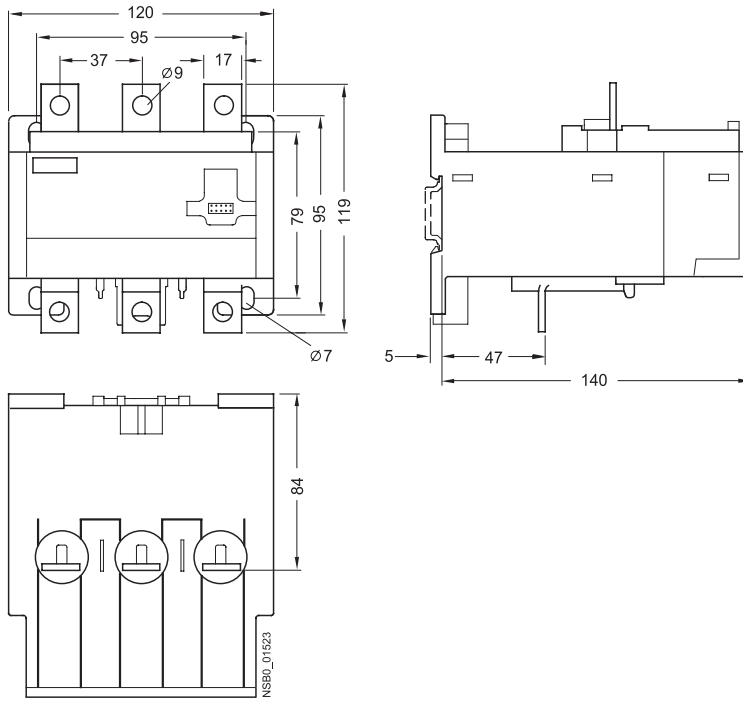

3RB29 56-2TH2 current measuring module

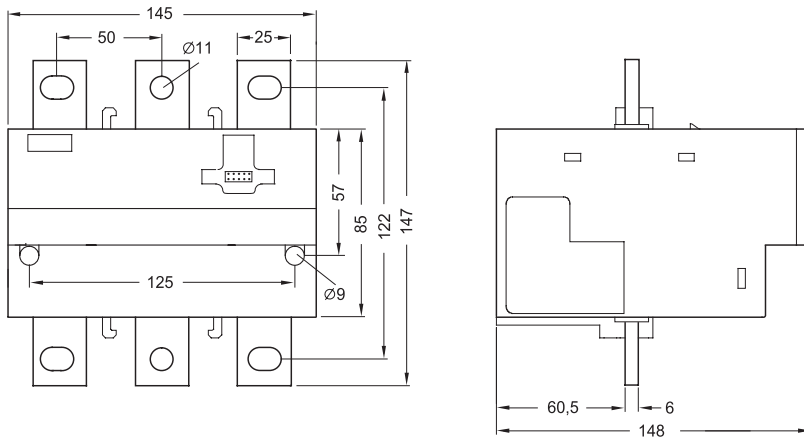

3RB29 66-2WH2 current measuring module

# 3RB2 Solid-State Overload Relays

3RB22, 3RB23 for standard applications

## Schematics

### Protection of single-phase motors

(not in conjunction with internal ground-fault detection)

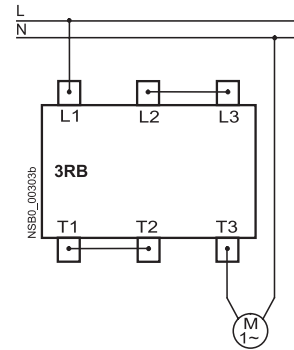
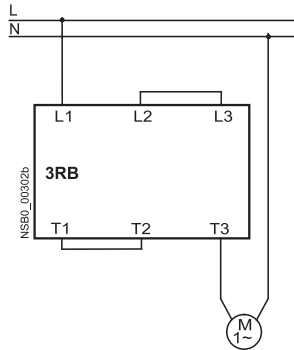

3RB29 06-2.G1, 3RB29 56-2TG2

3RB29 56-2TH2, 3RB29 66-2WH2

### Schematic representation of a possible application (3-phase)

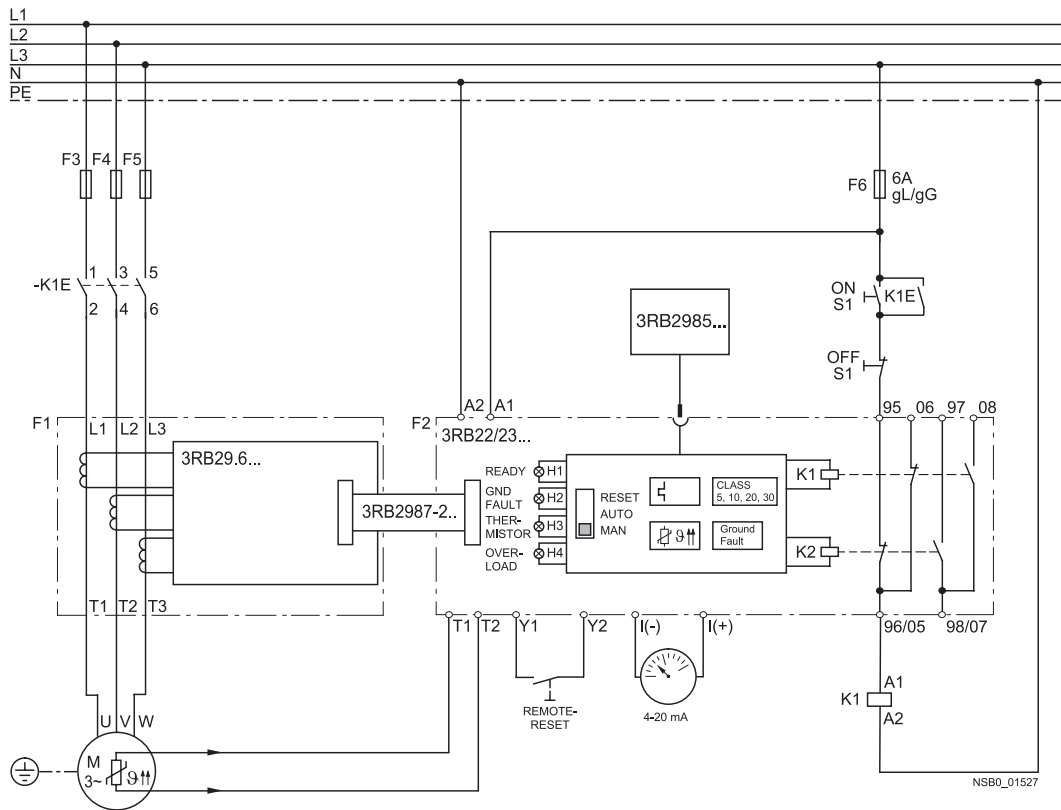

## 3RB2 Solid-State Overload Relays

## 3RB22, 3RB23 for standard applications

## Connections

Evaluation module	Function expansion module	Basic functions	Inputs		
			A1/A2	T1/T2	Y1/Y2
3RB22 83-4AA1 3RB22 83-4AC1 3RB23 83-4AA1 3RB23 83-4AC1	None	Inverse-time delayed protection, temperature-dependent protection, electrical remote RESET, overload warning	Power supply 24 ... 240 V AC/DC	Connection for PTC sensor	Electrical remote RESET
	3RB29 85-2CA1	Inverse-time delayed protection, temperature-dependent protection, internal ground-fault detection, electrical remote RESET, overload warning	Power supply 24 ... 240 V AC/DC	Connection for PTC sensor	Electrical remote RESET
	3RB29 85-2CB1	Inverse-time delayed protection, temperature-dependent protection, internal ground-fault detection, electrical remote RESET, ground fault signal	Power supply 24 ... 240 V AC/DC	Connection for PTC sensor	Electrical remote RESET
	3RB29 85-2AA0	Inverse-time delayed protection, temperature-dependent protection, electrical remote RESET, overload warning, analog output	Power supply 24 ... 240 V AC/DC	Connection for PTC sensor	Electrical remote RESET
	3RB29 85-2AA1	Inverse-time delayed protection, temperature-dependent protection, internal ground-fault detection, electrical remote RESET, overload warning, analog output	Power supply 24 ... 240 V AC/DC	Connection for PTC sensor	Electrical remote RESET
	3RB29 85-2AB1	Inverse-time delayed protection, temperature-dependent protection, internal ground-fault detection, electrical remote RESET, ground fault signal, analog output	Power supply 24 ... 240 V AC/DC	Connection for PTC sensor	Electrical remote RESET

Evaluation module	Function expansion module	Outputs				
		I (-) / I (+)	95/96 NC	97/98 NO	05/06 NC	07/08 NO
3RB22 83-4AA1 3RB22 83-4AC1 3RB23 83-4AA1 3RB23 83-4AC1	None	No	Switching off the contactor (inverse-time delayed/temperature-dependent protection)	Signal "tripped"	Overload warning	Overload warning
	3RB29 85-2CA1	No	Switching off the contactor (inverse-time delayed/temperature-dependent protection + ground fault)	Signal "tripped"	Overload warning	Overload warning
	3RB29 85-2CB1	No	Switching off the contactor (inverse-time delayed/temperature-dependent protection)	Signal "tripped"	Switching off the contactor (ground fault)	Signal "ground fault trip"
	3RB29 85-2AA0	Analog signal	Switching off the contactor (inverse-time delayed/temperature-dependent protection)	Signal "tripped"	Overload warning	Overload warning
	3RB29 85-2AA1	Analog signal	Switching off the contactor (inverse-time delayed/temperature-dependent protection + ground fault)	Signal "tripped"	Overload warning	Overload warning
	3RB29 85-2AB1	Analog signal	Switching off the contactor (inverse-time delayed/temperature-dependent protection)	Signal "tripped"	Switching off the contactor (ground fault)	Signal "ground fault trip"

## Overview

### Overload relays for standard applications

The following accessories are available for the 3RB2/3RB3 solid-state overload relays:



- One terminal bracket each for the overload relays size S00 and S0 (sizes S2 to S12 can be installed as single units without a terminal bracket)
- One mechanical RESET module for all sizes
- One cable release for resetting devices which are difficult to access (for all sizes)
- One sealable cover for all sizes
- Box terminal blocks for sizes S6 and S10/S12
- Terminal covers for sizes S2 to S10/S12

### Overload relays for high-feature applications

The following accessories are available for the 3RB22/3RB23 solid-state overload relays:

- A sealable cover for the evaluation module
- Box terminal blocks for the current measuring modules size S6 and S10/S12
- Terminal covers for the current measuring modules size S6 and S10/S12
- Push-in lugs for screw mounting the size S00 to S3 current measuring modules

## Selection and ordering data







Version	Size	Order No.	Weight per PU approx. kg		
<b>Terminal brackets for stand-alone installation <sup>1) 2)</sup></b>					
 <p>3RU29.6-3AA01</p>	For separate mounting of the overload relay panel mount or snapped onto 35 mm standard mounting rail, size S3 also for 75 mm standard mounting rail	<i>Screw terminals</i> S00	<b>3RU29 16-3AA01</b>	0.04	
			S0	<b>3RU29 26-3AA01</b>	0.05
			S2	<b>3RU29 36-3AA01</b>	0.18
			S3	<b>3RU29 46-3AA01</b>	0.28
		<i>Spring Loaded terminals</i> S00	<b>3RU29 16-3AC01</b>	0.04	
		S0	<b>3RU29 26-3AC01</b>	0.06	
<b>Mechanical RESET <sup>1) 2)</sup></b>					
 <p>3RU19 00-1A with pushbutton and extension plunger</p>	<b>Resetting plungers, holders and formers</b>	S00 to S3	<b>3RB39 80-0A</b>	0.030	
		S6 to S12	<b>3RU19 00-1A</b>	0.038	
	<b>Pushbuttons with extended stroke</b> (12 mm), IP65, Ø 22 mm	S3 to S12	<b>3SU1200-0FB10-0AA0</b>	0.020	
		<b>Extension plungers</b> For compensation of the distance between a pushbutton and the unlatching button of the relay	S3 to S12	<b>3SX1 335</b>	0.020
	<b>Complete mechanical reset assembly</b>	S3 to S12	<b>3SBES-RESET</b>		
<b>Cable releases with holder for RESET <sup>1) 2)</sup></b>					
 <p>3RU19 00-1.</p>	For holes with Ø 6.5 mm in the mounting plate; max. control panel thickness 8 mm	• Length 400 mm	S00 to S2	<b>3RB39 80-0B</b>	0.060
		• Length 600 mm	S00 to S2	<b>3RB39 80-0C</b>	0.073
		• Length 400 mm	S3 to S12	<b>3RU19 00-1B</b>	0.063
		• Length 600 mm	S3 to S12	<b>3RU19 00-1C</b>	0.073

1) Accessories with a prefix of 3RB39 are intended for 3RB20/3RB30 overload relays only.

2) Only for 3RB20/3RB21. The accessories are identical to those of the 3RU1/3RU2 thermal overload relays.

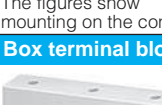
# 3RB2 Solid-State Overload Relays

## Accessories

Version	Size	Order No.	List Price \$	Pack Units	Weight per PU approx. kg
<b>Sealable covers</b>					
 3RB3984-0	For covering the setting knobs				
	• For 3RB30/3RB31	S00 to S3	<b>3RB39 84-0</b>	10 units	0.003
	• For 3RB20/3RB21	S6 to S12	<b>3RB29 84-0</b>	10 units	0.020
	• For 3RB22 to 3RB24	–	<b>3RB29 84-2</b>	10 units	0.050
<b>Terminal covers</b>					
 3RT19 46-4EA1	<b>Covers for cable lugs and rail connection</b>				
	• Length 100 mm	S6	<b>3RT19 56-4EA1</b>		0.067
	• Length 120 mm	S10/S12	<b>3RT19 66-4EA1</b>		0.124
 3RT19 36-4EA2	<b>Covers for box terminals</b>				
	• Length 20.6 mm <sup>1)</sup>	S2	<b>3RT29 36-4EA2</b>		0.016
	• Length 20.8 mm <sup>1)</sup>	S3	<b>3RT29 46-4EA2</b>		0.023
	• Length 25 mm	S6	<b>3RT19 56-4EA2</b>		0.028
	• Length 30 mm	S10/S12	<b>3RT19 66-4EA2</b>		0.038
 3RT19 56-4EA3 The figures show mounting on the contactor	<b>Covers for screw connections</b> between contactor and overload relay, without box terminals (1 unit required per combination)	S6	<b>3RT19 56-4EA3</b>		0.021
		S10/S12	<b>3RT19 66-4EA3</b>		0.062
<b>Box terminal blocks</b>					
 3RT19 5.-4G	For round and ribbon cables up to 70 mm <sup>2</sup> 2/0 AWG	S6 <sup>2)</sup>	<b>3RT19 55-4G</b>		0.237
	up to 120mm <sup>2</sup> 4/0 AWG	S6	<b>3RT19 56-4G</b>		0.270
	up to 240mm <sup>2</sup> 500 mcm	S10/S12	<b>3RT19 66-4G</b>		0.676
	For conductor cross-sections, see LV 1 T "Technical Specifications"				
<b>Push-in lugs</b>					
 3RP19 03	For screw fixing of 3RB22/3RB23 overload relays	--	<b>3RP19 03</b>	10 units	0.002
	 3RB19 00-0B	For screw mounting of 3RB29 06 current measuring modules (2 units are required per module)	S00 ... S3	<b>3RB29 00-0B</b>	10 units

For more accessories (tools for spring-loaded terminals and labeling plates), see page 3/57.

1) Only for 3RB20/3RB21. The accessories are identical to those of the 3RU11 thermal overload relays.

2) In the scope of supply for 3RT10 54-1 contactors (55 kW).



# 3RB2 Solid-State Overload Relays

## Accessories

### Overview

#### Overload relays for standard applications

The following accessories are available for the 3RB20/3RB21 solid-state overload relays:

- One terminal bracket each for the overload relays size S00 and S0 (sizes S2 to S12 can be installed as stand-alone installation without a terminal bracket)
- One mechanical remote RESET module for all sizes
- One cable release for resetting devices which are difficult to access (for all sizes)
- One sealable cover for all sizes
- Box terminal blocks for sizes S6 and S10/S12
- Terminal covers for sizes S2 to S10/S12

#### Overload relays for High-Feature applications

The following accessories are available for the 3RB22/3RB23 solid-state overload relays:

- A sealable cover for the evaluation module
- Box terminal blocks for the current measuring modules size S6 and S10/S12
- Terminal covers for the current measuring modules size S6 and S10/S12

### Technical specifications

#### Terminal brackets for stand-alone installation

Type	3RB29 13-0AA1	3RB29 23-0AA1
For overload relay	3RB20 16, 3RB21 13	3RB20 26, 3RB21 23
Size	S00	S0
Type of mounting	For screw and snap-on mounting onto TH35 standard mounting rail	
<b>Connection for main circuit</b>		
Connection type	Screw terminal	
<b>Screw terminal</b>		
• Terminal screw	Pozidriv size 2	
• Tightening torque	Nm 0.8 ... 1.2	2 ... 2.5
• Conductor cross-section (min./max.), 1 or 2 conductors		
- Solid	mm <sup>2</sup> 1 × (0.5 ... 2.5), Max. 1 × (... 4)	1 × (1 ... 6), Max. 1 × (... 10)
- Finely stranded without end sleeve	mm <sup>2</sup> --	--
- Finely stranded with end sleeve	mm <sup>2</sup> 1 × (0.5 ... 2.5)	1 × (1 ... 6)
- Stranded	mm <sup>2</sup> 1 × (0.5 ... 2.5), Max. 1 × (... 4)	1 × (1 ... 6), Max. 1 × (... 10)
- AWG conductors, solid or stranded	AWG 1 × (18 ... 14)	1 × (14 ... 10)

## 3RB24 Solid-State Overload Relays

3RB24 for IO-Link, up to 630 A for High-Feature applications

## Overview

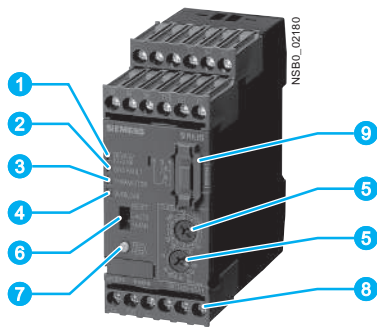

- 1 Green LED "DEVICE/IO-Link":  
A continuous green light signals that the device is working correctly, a green flickering light signals the communication through IO-Link.
- 2 Red LED "GND FAULT":  
A continuous red light signals an active ground-fault trip.
- 3 Red LED "THERMISTOR":  
A continuous red light signals an active thermistor trip.
- 4 Red LED "OVERLOAD":  
A continuous red light signals an active overload trip; a flickering red light signals an imminent trip (overload warning).
- 5 Motor current and trip class setting:  
Setting the device to the motor current and to the required trip class dependent on the start-up conditions is easy with the two rotary switches.
- 6 Selector switch for manual/automatic RESET:  
With this switch you can choose between manual and automatic RESET.
- 7 Test/RESET button:  
Enables testing of all important device components and functions, plus resetting of the device after a trip when manual RESET is selected.
- 8 Connecting terminals (removable terminal block):  
The generously sized terminals permit connection of two conductors with different cross-sections for the auxiliary, control and sensor circuits. Connection is possible with screw connection and alternatively with spring-type connection.
- 9 Plug-in point for operator panel:  
enables connection of the 3RA69 35-0A operator panel.

## SIRIUS 3RB24 evaluation module

The modular electronic overload relay 3RB24, which is powered via IO-Link (with monostable auxiliary contacts) up to 630 A (up to 820 A possible with a series transformer) have been designed for inverse-time delayed protection of loads with normal and heavy starting ("Function" see "Manual for SIRIUS 3RB24 Solid-State Overload Relay for IO-Link".) against excessive temperature rises due to overload, phase unbalance or phase failure. It comprises an evaluation unit, a current measuring module and a connecting cable. The evaluation module 3RB24 also offers an motor starter function: The contactors, which are connected via the auxiliary contacts, can also be actuated for operation via IO-Link. In this way, direct, reversing and star-delta starters up to 630 A (or 830 A) can be connected to the controller wirelessly via the IO-Link controller.

An overload, phase unbalance or phase failure result in an increase of the motor current beyond the set rated motor current.

This current rise is detected by means of the current measuring module (see page 3/55) and electronically evaluated by the evaluation module which is connected to it. The evaluation electronics sends a signal to the auxiliary contacts. The auxiliary contacts then switch off the load by means of a contactor. The

break time depends on the ratio between the tripping current and current setting  $I_e$  and is stored in the form of a long-term stable tripping characteristic (see [www.siemens.com/sirius/support](http://www.siemens.com/sirius/support) → "Characteristic Curves"). The "tripped" status is signaled by means of a continuously illuminated red "OVERLOAD" LED and also reported as a group fault via IO-Link.

The LED indicates imminent tripping of the relay due to overload, phase unbalance or phase failure by flickering when the limit current has been violated. This warning can also be reported to the higher-level PLC via IO-Link at the 3RB24 overload relay.

In addition to the described inverse-time delayed protection of loads against excessive temperature rises, the 3RB24 solid-state overload relays also allow direct temperature monitoring of the motor windings (full motor protection) by connection with broken-wire interlock of a PTC sensor circuit. With this temperature-dependent protection, the loads can be protected against overheating caused indirectly by reduced coolant flow, for example, which cannot be detected by means of the current alone. In the event of overheating, the devices switch off the contactor, and thus the load, by means of the auxiliary contacts. The "tripped" status is signaled by means of a continuously illuminated "THERMISTOR" LED and also reported as a group fault via IO-Link.

To the loads against incomplete ground faults due to damage to the insulation, humidity, condensation, etc., to protect the electronic overload relay 3RB24 offer the possibility of internal ground-fault detection (for details see "Manual for SIRIUS 3RB24 Solid-State Overload Relay for IO-Link", not possible in conjunction with contactor assembly for wye-delta starting). In the event of a ground fault, the 3RB24 relays trip instantaneously.

The "tripped" status is signaled by means of a flashing red LED "Ground Fault" and reported at the overload relay 3RB24 as a group fault via IO-Link.

The reset after overload, phase unbalance, phase failure, thermistor or ground-fault tripping is performed manually by key on site, via IO-Link or by electrical remote RESET or automatically after the cooling time (motor model) or for thermistor protection after sufficient cooling. Power cuts in devices due to function monitoring (broken wire or short circuit on the thermistor) can only be reset on-site ("Function" see "Manual for SIRIUS 3RB24 Solid-State Overload Relay for IO-Link"). In conjunction with a function expansion module, the motor current measured by the microprocessor can be output in the form of an analog signal DC 4 to 20 mA for operating rotary coil instruments or for feeding into analog inputs of programmable logic controllers.

The current values can be transmitted to the higher-level controller via IO-Link.

The devices are manufactured in accordance with environmental guidelines and contain environmentally friendly and reusable materials.

They comply with all important worldwide standards and approvals.

**Type of protection "increased safety EEx e and explosion-proof enclosure EEx d" in accordance with ATEX Directive 94/9/EC**

The electronic overload relay 3RB24 (monostable) are suitable for the overload protection of explosion-proof motors of types of protection EEx e and EEx d.

They comply with the requirements of EN 60079-7 (Electrical apparatus for areas subject to explosion hazards - Increased safety "e" as well as for flameproof enclosure "d"); see [www.siemens.com/sirius/atex](http://www.siemens.com/sirius/atex).

EC type test certificate for Group II, Category (2) G/D has been submitted. On request.

# 3RB24 Solid-State Overload Relays

3RB24 for IO-Link, up to 630 A for High-Feature applications

### Order No. scheme

Digit of the Order No.	1st - 3rd	4th	5th	6th	7th	8th	9th	10th	11th			
Solid-state overload relays	□□□	□	□	□	□	-	□	□	□			
SIRIUS 2nd generation	3 R B											
Device series	2											
Size, rated operational current and power				□								
Version of the automatic RESET, electrical remote RESET				□								
Trip class (CLASS)						□						
Setting range of the overload release						□						
Connection methods								□				
Installation type								□				
Example	3	R	B	2	4	8	3	-	4	A	A	1

**Note:**

The Order No. scheme is presented here merely for information purposes and for better understanding of the logic behind the order numbers.

For your orders, please use the order numbers quoted in the catalog in the Selection and ordering data.

### Benefits

The most important features and benefits of the 3RB24 solid-state overload relays for IO-Link are listed in the overview table (see "General Data", page 3/2 onwards).

### Advantages through energy efficiency

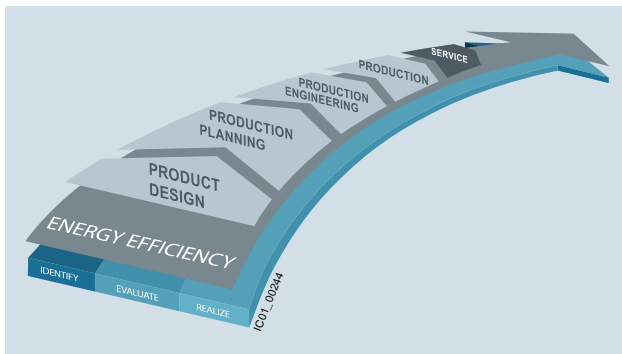

Overview of the energy management process

We offer you a unique portfolio for industrial energy management, using an energy management system that helps to optimally define your energy needs. We split up our industrial energy management into three phases – Identification, Evaluation and Realization – and we support you with the appropriate hardware and software solutions in every process phase.

The innovative products of the SIRIUS industrial controls portfolio can also make a substantial contribution to a plant's energy efficiency (see [www.siemens.com/sirius/energysaving](http://www.siemens.com/sirius/energysaving)).

3RB24 solid-state overload relays for IO-Link contribute to energy efficiency throughout the plant as follows:

- Transmission of current values
- Reduced inherent power loss
- Less heating of the control cabinet
- Smaller control cabinet air conditioners can be used

### Application

#### Industries

The 3RB24 solid-state overload relays are suitable for customers from all industries who want to guarantee optimum inverse-time delayed and temperature-dependent protection of their electrical loads (e.g. motors) under normal and heavy starting conditions (CLASS 5 to 30), minimize project completion times, inventories and energy consumption, and optimize plant availability and maintenance management.

#### Application

The 3RB24 solid-state overload relays have been designed for the protection of three-phase asynchronous and single-phase AC motors.

In addition to protection function, these devices can be used together with contactors as direct or reversing starters (star-delta (wye-delta) start also possible), which are controlled via IO-Link. This makes it possible to directly control drives via IO-Link from a higher-level controller or on site via the optional hand-held device lamps and also, for example, to return current values directly via IO-Link.

If single-phase AC motors are to be protected by the 3RB24 solid-state overload relays, the main current paths of the current measuring modules must be series-connected ("Schematics" see "Manual for SIRIUS 3RB24 Solid-State Overload Relay for IO-Link").

#### Ambient conditions

The devices are insensitive to external influences such as shocks, corrosive ambient conditions, ageing and temperature fluctuations.

For the temperature range from -25 °C to +60 °C, the 3RB24 solid-state overload relays compensate the temperature in accordance with IEC 60947-4-1.

Configuration notes for use of the devices below -25 °C or above +60 °C on request.

# 3RB24 Solid-State Overload Relays

3RB24 for IO-Link, up to 630 A for High-Feature applications

### Selection and ordering data

**3RB24 solid-state overload relays (evaluation module) for full motor protection, stand-alone installation, CLASS 5, 10, 20 and 30, adjustable**

Type	3RB24 83-4A.1
<b>Features and technical specifications</b>	
Overload protection, phase failure protection and unbalance protection	✓
Supplied from an external voltage	✓ 24 V DC through IO-Link
Direct-on-line or reversing starters (wye-delta starting also possible) controllable through IO-Link	✓
Auxiliary contacts	✓ 1 CO and 1 NO in series
Manual and automatic RESET	✓
Remote-RESET	✓ (electrically or via IO-Link)
4 LEDs for operating and status displays	✓
TEST function and self-monitoring	✓
Internal ground-fault detection	✓
Screw or spring-type terminals for auxiliary, control and sensor circuits	✓
Input for PTC sensor circuit	✓
Analog output	✓
<b>IO-Link-specific functions</b>	
• Connection of direct-on-line, reversing and star-delta starters to the controller via IO-Link	✓
• On-site controlling of the starter using the hand-held device	✓
• Accessing process data (e.g. current values in all three phases) via IO-Link	✓
• Accessing parameterization and diagnostics data (e.g. tripped signals) via IO-Link	✓

✓ Available



PU (UNIT, SET, M) = 1  
 PS\* = 1 unit  
 PG = 41G



3RB24 83-4AA1



3RB24 83-4AC1

Size of contactor	Version	Screw terminals 		Spring-type terminals 	
		Order No.	Price per PU	Order No.	Price per PU
<b>Evaluation modules</b>					
S00 ... S12	Monostable	<b>3RB24 83-4AA1</b>		<b>3RB24 83-4AC1</b>	

Notes:

- Analog input modules, e.g. SM 331, must be configured for 4-wire measuring transducers. The analog input module may not supply current to the analog output of the 3RB24 relay.





Current measuring modules and related connecting cables [see page 3/55](#), accessories [see pages 3/56 and 3/57](#).

# 3RB24 Solid-State Overload Relays

Current measuring modules for 3RB22, 3RB23, 3RB24

## Selection and ordering data

*Current measuring modules for mounting onto contactor<sup>1)</sup> and stand-alone installation<sup>1)2)</sup> (essential accessories)*

Size con-tactor <sup>3)</sup>	Rating for induction motor, <sup>4)</sup>	Current setting of the inverse-time delayed overload release	Short-circuit protection with fuse, type of coordination "2", operational class gG <sup>5)</sup>	For over-load relays	DT	Order No.	Price per PU	PU (UNIT, SET, M)	Pack Units	PG
	kW	A	A							
<b>Sizes S00/S0<sup>2)6)</sup></b>										
	S00/S0	0.09 ... 1.1	0.3 ... 3	20	3RB22 to 3RB24	▶ <b>3RB29 06-2BG1</b>		1	1 unit	41G
		1.1 ... 11	2.4 ... 25	63						
<b>Sizes S2/S3<sup>2)6)</sup></b>										
	S2/S3	5.5 ... 45	10 ... 100	315	3RB22 to 3RB24	▶ <b>3RB29 06-2JG1</b>		1	1 unit	41G
<b>Size S6<sup>1)6)</sup></b>										
	S6 with busbar connection	11 ... 90	20 ... 200	315	3RB22 to 3RB24	▶ <b>3RB29 56-2TH2</b>		1	1 unit	41G
	For mounting to S6 contactors with box terminals				3RB22 to 3RB24	▶ <b>3RB29 56-2TG2</b>		1	1 unit	41G
<b>Sizes S10/S12<sup>1)</sup></b>										
	S10/S12 and size 14 (3TF68/3TF69)	37 ... 450	63 ... 630	800	3RB22 to 3RB24	▶ <b>3RB29 66-2WH2</b>		1	1 unit	41G

**Note:**

The connecting cable between the current measuring module and the evaluation module is not included in the scope of supply; please order separately.

- 1) The current measuring modules with an Order No. ending with "2" are designed for mounting onto contactor and stand-alone installation. For 3TF68/3TF69 contactors, direct mounting is not possible.
- 2) The current measuring modules with an Order No. ending with "1" are designed for stand-alone installation.

- 3) Observe maximum rated operational current of the devices.
- 4) Guide value for 4-pole standard motors at 50 Hz 400 V AC. The actual starting and rated data of the motor to be protected must be considered when selecting the units.
- 5) Maximum protection by fuse for overload relay, type of coordination "2". "Fuse Values in Connection with Contactors" see - "Configuration Manual for Configuring SIRIUS – Selection Data for Load Feeders in Fuseless and Fused Designs" - "Configuration Manual for Configuring SIRIUS Innovations – Selection Data for Load Feeders in Fuseless and Fused Designs".
- 6) The modules with an Order No. with "G" in penultimate position are equipped with a straight-through transformer.

## Accessories

Size of con-tactor	Version	For over-load relays	DT	Order No.	Price per PU	PU (UNIT, SET, M)	Pack Units	PG
<b>Connecting cables (necessary accessories)</b>								
	S00 ... S3	For connection between evaluation module and current measuring module		▶ <b>3RB29 87-2B</b>		1	1 unit	41F
		• Length 0.1 m (only for mounting of the evaluation module directly onto the current measuring module)	3RB24, 3RB29					
3RB29 87-2.	S00 ... S12	• Length 0.5 m	3RB24, 3RB29	▶ <b>3RB29 87-2D</b>		1	1 unit	41F

Additional general accessories [see page 3/57](#).

# 3RB24 Solid-State Overload Relays

## Accessories for 3RB22, 3RB23, 3RB24

### Overview

#### Overload relays for High-Feature applications

The following optional accessories are available for the 3RB22 to 3RB24 solid-state overload relays:

- Operator panel for the evaluation modules 3RB24
- Manual 3RB24
- Sealable cover for the evaluation modules 3RB22 to 3RB24
- Terminal covers for the 3RB29 current measuring modules sizes S6 and S10/S12
- Box terminal blocks for the 3RB29 current measuring modules sizes S6 and S10/S12
- Push-in lugs for screw fixing for 3RB22 to 3RB24 evaluation modules and 3RB29 06 current measuring modules

### Selection and ordering data

#### Accessories for overload relay 3RB24

Version	For over-load relays	DT	Order No.	Price per PU	PU (UNIT, SET, M)	Pack Units	PG
<b>Operator panels for evaluation modules</b>							
 <p>3RA69 35-0A</p>	<b>Operator panels (set)</b>	3RB24	A	<b>3RA69 35-0A</b>	1	1 unit	42F
	1 set comprises: <ul style="list-style-type: none"> <li>• 1 x operator panel</li> <li>• 1 x 3RA69 36-0A enabling module</li> <li>• 1 x 3RA69 33-0B interface cover</li> <li>• 1 x fixing terminal</li> </ul> Note: The connecting cable between the evaluation module and the operator panel is not included in the scope of supply; please order separately.						
	<b>Connecting cable</b>	3RB24	▶	<b>3UF79 33-0BA00-0</b>	1	1 unit	42J
	<b>Enabling modules (replacement)</b>	3RB24	A	<b>3RA69 36-0A</b>	1	1 unit	42F
<b>Interface covers</b>	3RB24	A	<b>3RA69 33-0B</b>	1	5 units	42F	





<sup>1)</sup> The manual is also available as a free PDF download on the Internet at [www.siemens.com/sirius/support](http://www.siemens.com/sirius/support) → "Manuals/Operating Instructions".

Additional general accessories [see next page](#).

# 3RB24 Solid-State Overload Relays

Accessories for 3RB22, 3RB23, 3RB24

## General accessories

Version	Size	For over-load relays	Order No.	PU (UNIT, SET, M)	Pack Units
<b>Sealable covers for evaluation modules</b>					
	For covering the setting knobs	--	3RB22 to 3RB24	<b>3RB29 84-2</b>	1 10 units
<b>Terminal covers for current measuring modules</b>					
<b>Covers for cable lugs and busbar connections</b>					
	• Length 100 mm	S6	3RB29 56	<b>3RT19 56-4EA1</b>	1 1 unit
	• Length 120 mm	S10/S12	3RB29 66	<b>3RT19 66-4EA1</b>	1 1 unit
<b>Covers for box terminals</b>					
	• Length 25 mm	S6	3RB29 56	<b>3RT19 56-4EA2</b>	1 1 unit
	• Length 30 mm	S10/S12	3RB29 66	<b>3RT19 66-4EA2</b>	1 1 unit
<b>Covers for screw terminals</b>					
	between contactor and overload relay, without box terminals	S6	3RB29 56	<b>3RT19 56-4EA3</b>	1 1 unit
	(1 unit required per combination)	S10/S12	3RB29 66	<b>3RT19 66-4EA3</b>	1 1 unit
<b>Box terminal blocks for current measuring modules</b>					
	For round and ribbon cables				
	• Up to 70 mm <sup>2</sup>	S6 <sup>1)</sup>	3RB29 56	<b>3RT19 55-4G</b>	1 1 unit
	• Up to 120 mm <sup>2</sup>	S6	3RB29 56	<b>3RT19 56-4G</b>	1 1 unit
	• Up to 240 mm <sup>2</sup>	S10/S12	3RB29 66	<b>3RT19 66-4G</b>	1 1 unit
Technical specifications for conductor cross-sections see "Reference Manual for Protection Equipment-3RU1, 3RB2 Overload Relays".					
<b>Push-in lugs for evaluation modules and current measuring modules</b>					
	For screw fixing the evaluation modules	--	3RB22 to 3RB24	<b>3RP19 03</b>	1 10 units
	For screw fixing the current measuring modules (2 units per module)	S00 ... S3	3RB29 06	<b>3RB29 00-0B</b>	100 10 units

<sup>1)</sup> In the scope of supply for 3RT10 54-1 contactors (55 kW).

Version	Size	Color	For over-load relays	Order No.	PU (UNIT, SET, M)	Pack Units
---------	------	-------	----------------------	-----------	-------------------	------------

## Tools for opening spring-type terminals

	<b>Screwdrivers</b> For all SIRIUS devices with spring-type terminals	Length approx. 200 mm, 3.0 mm x 0.5 mm	Titanium gray/black, partially insulated	Main and auxiliary circuit connection: 3RB2	<b>3RA29 08-1A</b>	1 1 unit
---	--	---	--	---	--------------------	----------

## Blank labels

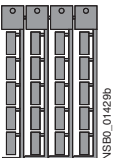
	<b>Unit labeling plates<sup>1)</sup></b> for SIRIUS devices	20 mm x 7 mm	Titanium gray	3RB24	<b>3RT29 00-1SB20</b>	100 340 units
		20 mm x 7 mm	Pastel turquoise	3RB22, 3RB23	<b>3RT29 00-1SB20</b>	100 340 units

<sup>1)</sup> PC labeling system for individual inscription of unit labeling plates available from: murrplastik Systemtechnik GmbH (see "Appendix" → "External Partners").



# 3RB24 Solid-State Overload Relays

3RB24 for IO-Link, up to 630 A for High-Feature applications

## Technical specifications

<b>Type – Overload relay of evaluation modules</b>	<b>3RB24 83-4A.1</b>	
<b>Size of contactor</b>	S00 ... S10/S12	
<b>General data</b>		
<b>Trips in the event of</b>	Overload, phase failure and phase unbalance (> 40 % according to NEMA), + ground fault (connectable and disconnectable) and activation of the thermistor motor protection (with closed PTC sensor circuit)	
<b>Trip class</b> acc. to IEC 60947-4-1	CLASS	5, 10, 20 and 30 adjustable
<b>Phase failure sensitivity</b>	Yes	
<b>Overload warning</b>	Yes, from $1.125 \times I_e$ for symmetrical loads and from $0.85 \times I_e$ for unsymmetrical loads	
<b>Reset and recovery</b>	Manual and automatic RESET, electrical remote RESET or through IO-Link	
<ul style="list-style-type: none"> <li>Reset options after tripping</li> <li>Recovery time                             <ul style="list-style-type: none"> <li>- For automatic RESET</li> </ul> </li> </ul>	min	<ul style="list-style-type: none"> <li>- for tripping due to overcurrent: 3 (stored permanently)</li> <li>- for tripping by thermistor: time until the motor temperature has fallen 5 K below the response temperature</li> </ul>
<ul style="list-style-type: none"> <li>- For manual RESET</li> </ul>	min	<ul style="list-style-type: none"> <li>- for tripping due to a ground fault: no automatic RESET</li> <li>- for tripping due to overcurrent: 3 (stored permanently)</li> <li>- for tripping by thermistor: time until the motor temperature has fallen 5 K below the response temperature</li> <li>- for tripping due to a ground fault: Immediately</li> </ul>
<ul style="list-style-type: none"> <li>- For remote RESET</li> </ul>	min	<ul style="list-style-type: none"> <li>- for tripping due to overcurrent: 3 (stored permanently)</li> <li>- for tripping by thermistor: time until the motor temperature has fallen 5 K below the response temperature</li> <li>- for tripping due to a ground fault: Immediately</li> </ul>
<b>Features</b>		
<ul style="list-style-type: none"> <li>Display of operating state on device</li> </ul>	Yes, with 4 LEDs <ul style="list-style-type: none"> <li>- Green LED "DEVICE/IO-Link"</li> <li>- Red "Ground Fault" LED</li> <li>- Red "Thermistor" LED</li> <li>- Red "Overload" LED</li> </ul>	
<ul style="list-style-type: none"> <li>TEST function</li> </ul>	Yes, test of LEDs, electronics, auxiliary contacts and wiring of control circuit by pressing the button TEST/RESET / self-monitoring	
<ul style="list-style-type: none"> <li>RESET button</li> <li>STOP button</li> </ul>	Yes, with the TEST/RESET button No	
<b>Explosion protection – Safe operation of motors with "increased safety EEx e and explosion-proof enclosure EEx d" type of protection</b>		
EC type test certificate number according to directive 94/9/EC (ATEX)	On request	
<b>Ambient temperatures</b>		
<ul style="list-style-type: none"> <li>Storage/transport</li> </ul>	°C	-40 ... +80
<ul style="list-style-type: none"> <li>Operation</li> </ul>	°C	-25 ... +60
<ul style="list-style-type: none"> <li>Temperature compensation</li> </ul>	°C	+60
<ul style="list-style-type: none"> <li>Permissible rated current                             <ul style="list-style-type: none"> <li>- Temperature inside control cabinet 60 °C</li> <li>- Temperature inside control cabinet 70 °C</li> </ul> </li> </ul>	%	100 On request
<b>Repeat terminals</b>		
<ul style="list-style-type: none"> <li>Coil repeat terminals</li> <li>Auxiliary contact repeat terminal</li> </ul>	Not required Not required	
<b>Degree of protection</b> acc. to IEC 60529	IP20: Current measuring modules in sizes S6 and S10/S12 with busbar connection in conjunction with the cover	
<b>Touch protection</b> acc. to IEC 61140	Finger-safe: Current measuring modules in sizes S6 and S10/S12 with busbar connection in conjunction with the cover	
<b>Shock resistance with sine</b> acc. to IEC 60068-2-27	g/ms	15/11
<b>Electromagnetic compatibility (EMC) – Interference immunity</b>		
<ul style="list-style-type: none"> <li>Conductor-related interference                             <ul style="list-style-type: none"> <li>- Burst acc. to IEC 61000-4-4 (corresponds to degree of severity 3) kV</li> <li>- Surge acc. to IEC 61000-4-5 (corresponds to degree of severity 3) kV</li> </ul> </li> <li>Electrostatic discharge according to IEC 61000-4-2 (corresponds to degree of severity 3) kV</li> <li>Field-related interference according to IEC 61000-4-3 (corresponds to degree of severity 3) V/m</li> </ul>	2 (power ports), 1 (signal ports) 2 (line to earth), 1 (line to line) 8 (air discharge), 6 (contact discharge) 10	
<b>Electromagnetic compatibility (EMC) – emitted interference</b>	Degree of severity A according to EN 55011 (CISPR 11) and EN 55022 (CISPR 22)	
<b>Resistance to extreme climates – air humidity</b>	%	100
<b>Dimensions</b>	"Dimensional drawings" see <a href="#">"Manual for SIRIUS 3RB24 Solid-State Overload Relay for IO-Link"</a> .	
<b>Installation altitude above sea level</b>	m	Up to 2000
<b>Mounting position</b>	Any	
<b>Type of mounting</b>		
<ul style="list-style-type: none"> <li>Evaluation modules</li> <li>Current measuring module</li> </ul>	Size	Stand-alone installation S00 to S3: Stand-alone installation, S6 and S10/S12: stand-alone installation or mounting onto contactors

# 3RB24 Solid-State Overload Relays



3RB24 for IO-Link, up to 630 A for High-Feature applications

<b>Type – Overload relay of evaluation modules</b>			<b>3RB24 83-4A.1</b>
Size of contactor			S00 ... S10/S12
Dimensions of evaluation modules (W x H x D)			45 x 111 x 95
<b>Auxiliary circuit</b>			
<b>Number of auxiliary switches</b>		1 CO contact, 1 NO contact connected in series internally	
<b>Auxiliary contacts – assignment</b>		<ul style="list-style-type: none"> <li>• 1 CO contact for selecting the contactor (for reversing starter function), actuated by the control system</li> <li>• 1 NO contact for normal switching duty, actuated by the control system (opens automatically when tripping occurs)</li> </ul>	
<b>Rated insulation voltage <math>U_i</math></b> (pollution degree 3)	V	300	
<b>Rated impulse withstand voltage <math>U_{imp}</math></b>	kV	4	
<b>Auxiliary contacts – contact rating</b>			
• NC contact with alternating current AC-14/AC-15, rated operational current $I_e$ at $U_e$	A		
- 24 V	A	6	
- 120 V	A	6	
- 125 V	A	6	
- 250 V	A	3	
• NO contact with alternating current AC-14/AC-15, rated operational current $I_e$ at $U_e$	A		
- 24 V	A	6	
- 120 V	A	6	
- 125 V	A	6	
- 250 V	A	3	
• NC contact, NO contact with direct current DC-13, rated operational current $I_e$ at $U_e$	A		
- 24 V	A	2	
- 60 V	A	0.55	
- 110 V	A	0.3	
- 125 V	A	0.3	
- 250 V	A	0.2	
• Conventional thermal current $I_{th}$	A	5	
• Contact reliability (suitability for PLC control; 17 V, 5 mA)		Yes	
<b>Short-circuit protection</b>			
• With fuse, operational class gG	A	6	
• With miniature circuit breaker, C characteristic	A	1.6	
<b>Protective separation between auxiliary conducting paths</b> acc. to IEC 60947-1	V	300	
<b>CSA, UL, UR rated data</b>			
<b>Auxiliary circuit – switching capacity</b>		B300, R300	
<b>Conductor cross-sections of the auxiliary circuit</b>			
<b>Connection type</b>		<b>Screw terminals</b>	
<b>Terminal screw</b>		M3, Pozidriv size 2	
<b>Operating devices</b>	mm	3.0 x 0.5	
<b>Prescribed tightening torque</b>	Nm	0.8 ... 1.2	
<b>Conductor cross-sections (min./max.), 1 or 2 conductors can be connected</b>			
• Solid	mm <sup>2</sup>	1 x (0.5 ... 4) <sup>1)</sup> , 2 x (0.5 ... 2.5) <sup>1)</sup>	
• Finely stranded without end sleeve	mm <sup>2</sup>	--	
• Finely stranded with end sleeve	mm <sup>2</sup>	1 x (0.5 ... 2.5) <sup>1)</sup> , 2 x (0.5 ... 1.5) <sup>1)</sup>	
• Stranded	mm <sup>2</sup>	--	
• AWG cables, solid or stranded	AWG	2 x (20 ... 14)	
<b>Connection type</b>		<b>Spring-type terminals</b>	
<b>Operating devices</b>	mm	3.0 x 0.5	
<b>Conductor cross-sections (min./max.), 1 or 2 conductors can be connected</b>			
• Solid	mm <sup>2</sup>	2 x (0.25 ... 1.5)	
• Finely stranded without end sleeve	mm <sup>2</sup>	--	
• Finely stranded with end sleeve	mm <sup>2</sup>	2 x (0.25 ... 1.5)	
• AWG cables, solid or stranded	AWG	2 x (24 ... 16)	

1) If two different conductor cross-sections are connected to one clamping point, both cross-sections must be in the range specified

# 3RB24 Solid-State Overload Relays

3RB24 for IO-Link, up to 630 A for High-Feature applications

<b>Type – Overload relay of evaluation modules</b>		<b>3RB24 83-4A.1</b>
Size of contactor		S00 ... S10/S12
<b>Control and sensor circuit as well as the analog output</b>		
<b>Rated insulation voltage <math>U_i</math></b> (pollution degree 3)	V	300
<b>Rated impulse withstand voltage <math>U_{imp}</math></b>	kV	4
<b>Rated control supply voltage <math>U_s</math></b>		
• DC	V	24 through IO-Link
<b>Operating range</b>		
• DC		$0.85 \times U_{s\ min} \leq U_s \leq 1.1 \times U_{s\ max}$
<b>Rated power</b>		
• DC	W	0.5
<b>Mains buffering time</b>	ms	200
<b>Thermistor motor protection (PTC thermistor detector)</b>		
• Summation cold resistance	k $\Omega$	$\leq 1.5$
• Response value	k $\Omega$	3.4 ... 3.8
• Return value	k $\Omega$	1.5 ... 1.65
<b>Ground-fault detection</b>		
		The information refers to sinusoidal residual currents at 50/60 Hz.
• Tripping value $I_A$		
- For $0.3 \times I_e < I_{motor} < 2.0 \times I_e$		$> 0.3 \times I_e$
- For $2.0 \times I_e < I_{motor} < 8.0 \times I_e$		$> 0.15 \times I_{motor}$
• Response time $t_{trip}$	ms	500 ... 1 000
<b>Analog output<sup>1)</sup></b>		
• Output signal	mA	4 ... 20
• Measuring range		$0 \dots 1.25 \times I_e$ 4 mA corresponds to $0 \times I_e$ 16.8 mA corresponds to $1.0 \times I_e$ 20 mA corresponds to $1.25 \times I_e$
• Load, max.	$\Omega$	100
<b>Conductor cross-sections for the control and sensor circuit as well as the analog output</b>		
<b>Connection type</b>		 <b>Screw terminals</b>
<b>Terminal screw</b>		M3, Pozidriv size 2
<b>Operating devices</b>	mm	3.0 x 0.5
<b>Prescribed tightening torque</b>	Nm	0.8 ... 1.2
<b>Conductor cross-sections (min./max.), 1 or 2 conductors can be connected</b>		
• Solid	mm <sup>2</sup>	$1 \times (0.5 \dots 4)^2, 2 \times (0.5 \dots 2.5)^2$
• Finely stranded without end sleeve	mm <sup>2</sup>	—
• Finely stranded with end sleeve	mm <sup>2</sup>	$1 \times (0.5 \dots 2.5)^2, 2 \times (0.5 \dots 1.5)^2$
• Stranded	mm <sup>2</sup>	—
• AWG cables, solid or stranded	AWG	$2 \times (20 \dots 14)$
<b>Connection type</b>		 <b>Spring-type terminals</b>
<b>Operating devices</b>	mm	3.0 x 0.5
<b>Conductor cross-sections (min./max.), 1 or 2 conductors can be connected</b>		
• Solid	mm <sup>2</sup>	$2 \times (0.25 \dots 1.5)$
• Finely stranded without end sleeve	mm <sup>2</sup>	—
• Finely stranded with end sleeve	mm <sup>2</sup>	$2 \times (0.25 \dots 1.5)$
• Stranded	mm <sup>2</sup>	$2 \times (0.25 \dots 1.5)$
• AWG cables, solid or stranded	AWG	$2 \times (24 \dots 16)$

1) Analog input modules, e.g. SM 331, must be configured for 4-wire measuring transducers. The analog input module may not supply current to the analog output of the 3RB24 overload relay.

2) If two different conductor cross-sections are connected to one clamping point, both cross-sections must be in the range specified.

# 3RB24 Solid-State Overload Relays

Current measuring modules for 3RB22, 3RB23, 3RB24

## Overview

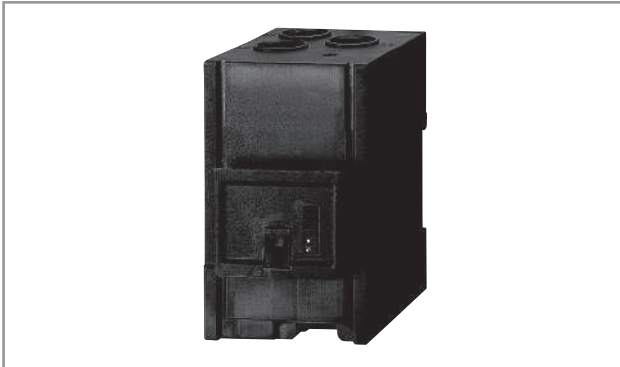

SIRIUS 3RB29 06 current measuring module

The current measuring modules are designed as system components for connecting to evaluation units 3RB22 to 3RB24. Using these evaluation units the motor current is measured and the measured value sent to the evaluation unit for evaluation. The current measuring modules in sizes S00 to S3 up to 55 mm wide are equipped with straight-through transformers and can be snap-fitted under the evaluation units. The larger evaluation units are installed directly on the contactor or as stand-alone units.

## Technical specifications

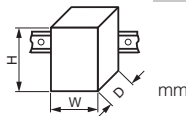
Type – Overload relays: Current measuring modules		3RB29 06		3RB29 56	3RB29 66
Size of contactor		S00/S0	S2/S3	S6	S10/S12
Dimensions of current measuring modules (W x H x D)	 mm	45 x 84 x 45	55 x 94 x 72	120 x 119 x 145	145 x 147 x 148
<b>Main circuit</b>					
Rated insulation voltage $U_i$ (pollution degree 3)	V	1 000			
Rated impulse withstand voltage $U_{imp}$	kV	6		8	
Rated operational voltage $U_e$	V	1 000			
Type of current		No			
• Direct current		Yes, 50/60 Hz $\pm 5\%$			
• Alternating current					
Current setting	A	0.3 ... 3; 2.4 ... 25	10 ... 100	20 ... 200	63 ... 630
Power loss per unit (max.)	W	0.5			
Short-circuit protection		See "Selection and ordering data" on page 3/55. See			
• With fuse without contactor					
• With fuse and contactor					
Protective separation between main and auxiliary conducting paths acc. to IEC 60947-1 (pollution degree 2)	V	690 for grounded networks, otherwise 600			

# 3RB24 Solid-State Overload Relays

Current measuring modules for 3RB22, 3RB23, 3RB24

**Type – Overload relays: Current measuring modules**

Size of contactor  
Dimensions of current measuring modules (W x H x D)

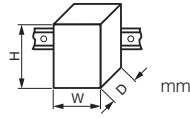

**Conductor cross-sections of the main circuit**

**Connection type**

3RB29 06		3RB29 56		3RB29 66	
S00/S0	S2/S3	S6		S10/S12	
45 x 84 x 45	55 x 94 x 72	120 x 119 x 145		145 x 147 x 148	

		Screw terminals with box terminal			
<b>Terminal screw</b>	mm	—	4 mm Allen screw		5 mm Allen screw
<b>Operating devices</b>	mm	—	4 mm Allen screw		5 mm Allen screw
<b>Prescribed tightening torque</b>	Nm	—	10 ... 12		20 ... 22

**Conductor cross-sections (min./max.), 1 or 2 conductors can be connected**

• Solid	mm <sup>2</sup>	—	—	—
• Finely stranded without end sleeve	mm <sup>2</sup>	—	With 3RT19 55-4G box terminal: 2 x (1 x max. 50, 1 x max. 70), 1 x (10 ... 70)	2 x (50 ... 185), rear clamping point only: 1 x (70 ... 240)
			With 3RT19 56-4G box terminal: 2 x (1 x max. 95, 1 x max. 120), 1 x (10 ... 120)	Rear clamping point only: 1 x (120 ... 185)
• Finely stranded with end sleeve	mm <sup>2</sup>	—	With 3RT19 55-4G box terminal: 2 x (1 x max. 50, 1 x max. 70), 1 x (10 ... 70)	2 x (50 ... 185), rear clamping point only: 1 x (70 ... 240)
			With 3RT19 56-4G box terminal: 2 x (1 x max. 95, 1 x max. 120), 1 x (10 ... 120)	Rear clamping point only: 1 x (120 ... 185)
• Stranded	mm <sup>2</sup>	—	With 3RT19 55-4G box terminal: 2 x (max. 70), 1 x (16 ... 70)	2 x (70 ... 240), rear clamping point only: 1 x (95 ... 300)
			With 3RT19 56-4G box terminal: 2 x (max. 120), 1 x (16 ... 120)	Rear clamping point only: 1 x (120 ... 240)
• AWG cables, solid or stranded	AWG	—	With 3RT19 55-4G box terminal: 2 x (max. 1/0), 1 x (6 ... 2/0)	2 x (2/0 ... 500 kcmil), rear clamping point only: 1 x (3/0 ... 600 kcmil)
			With 3RT19 56-4G box terminal: 2 x (max. 3/0), 1 x (6 ... 250 kcmil)	Rear clamping point only: 1 x (250 kcmil ... 500 kcmil)
• Ribbon cables (number x width x thickness)	mm	—	With 3RT19 55-4G box terminal: 2 x (6 x 15.5 x 0.8), 1 x (3 x 9 x 0.8 ... 6 x 15.5 x 0.8)	2 x (20 x 24 x 0.5), 1 x (6 x 9 x 0.8 ... 20 x 24 x 0.5)
			With 3RT19 56-4G box terminal: 2 x (10 x 15.5 x 0.8), 1 x (3 x 9 x 0.8 ... 10 x 15.5 x 0.8)	

**Connection type**

		Busbar connections			
<b>Terminal screw</b>	mm	—	M8 x 25		M10 x 30
<b>Prescribed tightening torque</b>	Nm	—	10 ... 14		14 ... 24

<b>Conductor cross-sections (min./max.), 1 or 2 conductors can be connected</b>					
• Solid with cable lug	mm <sup>2</sup>	—	16 ... 95 <sup>1)</sup>		50 ... 240 <sup>2)</sup>
• Stranded with cable lug	mm <sup>2</sup>	—	25 ... 120 <sup>1)</sup>		70 ... 240 <sup>2)</sup>
• AWG cable, solid or stranded, with cable lug	AWG	—	4 ... 250 kcmil		2/0 ... 500 kcmil
• with connecting bar (max. width)	mm	—	17		25

**Connection type**

		Straight-through transformers			
Diameter of opening	mm	7.5	14	25	—

<sup>1)</sup> When connecting cable lugs according to DIN 46235 with conductor cross-sections of 95 mm<sup>2</sup> and more, the 3RT19 56-4EA1 terminal cover must be used to ensure phase spacing.

<sup>2)</sup> When connecting cable lugs according to DIN 46234 with conductor cross-sections of 240 mm<sup>2</sup> and more as well as to DIN 46235 with conductor cross-sections of 185 mm<sup>2</sup> and more, the 3RT19 56-4EA1 terminal cover must be used for to keep the phase clearance.

# SIMOCODE pro 3UF7

## General data

### Overview



SIMOCODE pro S for efficient entry into motor management and SIMOCODE pro V for maximum functionality

#### More information

Home page, see [www.usa.siemens.com/simocode](http://www.usa.siemens.com/simocode)

Industry Mall, see [www.siemens.com/product?3UF7](http://www.siemens.com/product?3UF7)

SIMOCODE pro is a flexible, modular motor management system for motors with constant speeds in the low-voltage performance range. It optimizes the connection between I&C and motor feeder, increases plant availability and allows significant savings to be made for installation, commissioning, operation and maintenance of a system.

SIMOCODE pro offers, for example:

- Multifunctional, solid-state full motor protection that is independent of the automation system
- Integrated control functions instead of hardware for the motor control
- Detailed operational, service and diagnostics data
- Open communication via PROFIBUS DP, PROFINET/OPC UA, Modbus RTU or EtherNet/IP
- Safety relay function for the fail-safe disconnection of motors up to SIL 3 (IEC 61508, IEC 62061) or PL e with Category 4 (EN ISO 13849-1)
- SIMOCODE ES is the software package for SIMOCODE pro parameterization, start up and diagnostics.

#### Device series

##### SIMOCODE pro C

The compact system for direct-on-line starters and reversing starters or for controlling a motor starter protector.

##### SIMOCODE pro S

The smart system for direct-on-line, reversing, and wye-delta starters or for controlling a motor starter protector or soft starter. Its expandability with a multifunction module provides comprehensive input/output project data volume, precise ground-fault detection via the 3UL23 residual-current transformers and temperature measurement.

##### SIMOCODE pro V

The variable system with all control functions and with the possibility of expanding the inputs, outputs and functions of the system at will using expansion modules

Expansion possibilities	SIMOCODE pro C		pro S		pro V <sup>1)</sup>	
	PROFIBUS	PROFIBUS	PROFIBUS <sup>2)</sup>	PROFIBUS <sup>2)</sup>	Modbus RTU <sup>2)</sup>	PROFINET EtherNet/IP
Operator panels	✓	✓	✓	✓	✓	✓
Operator panels with display	--	--	✓	✓	✓	✓
Current measuring modules	✓	✓	✓	✓	✓	✓
Current/voltage measuring modules	--	--	✓	✓	✓	✓
Decoupling modules	--	--	✓	✓	✓	✓
Expansion modules:						
• Digital modules	--	--	2	2	2	2
• Fail-safe digital modules <sup>3)</sup>	--	--	1	1	1	1
• Analog modules	--	--	1	1	2	2
• Ground-fault modules	--	--	1	1	1	1
• Temperature modules	--	--	1	1	2	2
• Multifunction modules	--	1	--	--	--	--

✓ Available

-- Not available

<sup>1)</sup> Maximum of five expansion modules.

<sup>2)</sup> When an operator panel with display and/or a decoupling module are used, more restrictions on the number of expansion modules connectable per basic unit must be observed, see page 3/72.

<sup>3)</sup> The fail-safe digital module can be used instead of one of the two digital modules.

Per feeder each system always comprises one basic unit and one separate current measuring module. The two modules are connected together electrically through the system interface with a connection cable and can be mounted mechanically connected as a unit (one behind the other) or separately (side by side). The motor current to be monitored is decisive only for the choice of the current measuring module.

An operator panel for mounting in the control cabinet door is optionally connectable through a second system interface on the basic unit. Both the current measuring module and the operator panel are electrically supplied by the basic unit through the connection cable. More inputs, outputs and functions can be added to the SIMOCODE pro V and SIMOCODE pro S by means of optional expansion modules, thus supplementing the inputs and outputs already existing on the basic unit. With the DM-F Local and DM-F PROFIsafe fail-safe digital modules it is also possible to integrate the fail-safe disconnection of motors in the SIMOCODE pro V motor management system.

All modules are connected by connection cables. The connection cables are available in various lengths. The maximum distance between the modules (e.g. between the basic unit and the current measuring module) must not exceed 2.5 m. The total length of all the connection cables per system interface of the basic unit may be up to 3 m.

#### Note:

SIMOCODE pro can also be found in the TIA Selection Tool. The various system components can therefore be conveniently selected; see [www.siemens.com/tia-selection-tool](http://www.siemens.com/tia-selection-tool).

# SIMOCODE pro 3UF7

## General data

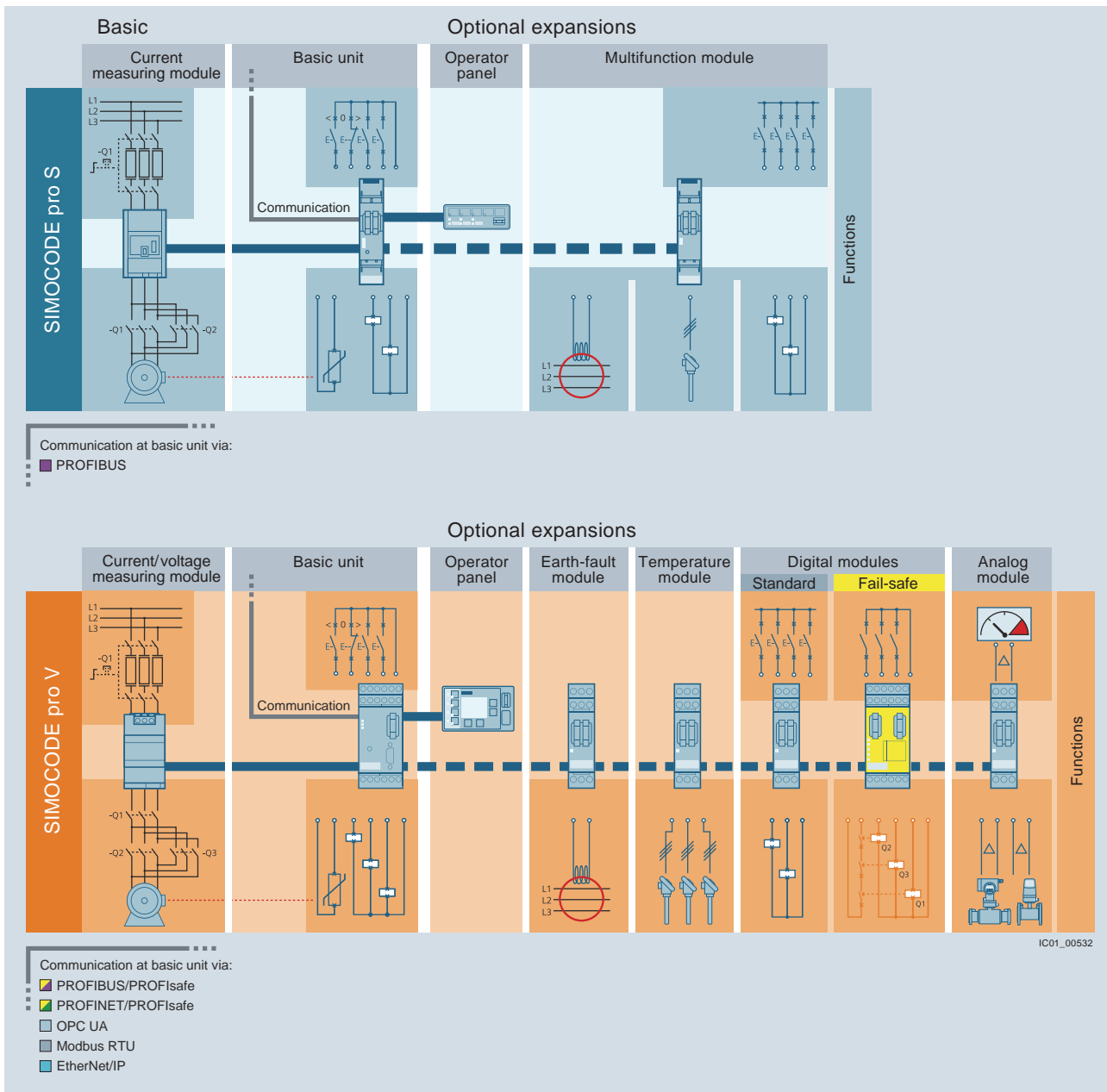

SIMOCODE pro S and SIMOCODE pro V: system structure

### Article No. scheme

Product versions		Article number	
<b>SIMOCODE pro motor management system</b>		<b>3UF7</b>	<input type="checkbox"/> <input type="checkbox"/> <input type="checkbox"/> - 1 <input type="checkbox"/> <input type="checkbox"/> <input type="checkbox"/> - 0
Type of unit/module	e.g. 0 = basic unit	<input type="checkbox"/>	<input type="checkbox"/>
Functional version of the module	e.g. 20 = SIMOCODE pro S	<input type="checkbox"/>	<input type="checkbox"/>
Connection type of the current transformer		<input type="checkbox"/>	<input type="checkbox"/>
Voltage version	e.g. B = 24 V DC	<input type="checkbox"/>	<input type="checkbox"/>
Enclosure color	e.g. 1 = titanium gray	<input type="checkbox"/>	<input type="checkbox"/>
Example		<b>3UF7</b>	<b>0 2 0 - 1 A B 0 1 - 0</b>

### Note:

The Article No. scheme shows an overview of product versions for better understanding of the logic behind the article numbers.

For your orders please use the article numbers quoted in the selection and ordering data.



## SIMOCODE pro 3UF7

## General data

## Benefits

**General customer benefits**

- Integrating the whole motor feeder into the process control by means of PROFIBUS DP, PROFINET/OPC UA, Modbus RTU or EtherNet/IP significantly reduces the wiring between the motor feeder and the PLC.
- Decentralization of the automated processes by means of configurable control and monitoring functions in the feeder saves resources in the automation system and ensures full functionality and protection of the feeder even if the I&C or bus system fails
- The acquisition and monitoring of operating, service and diagnostics data in the feeder and process control system increases plant availability as well as maintenance and service-friendliness
- The high degree of modularity allows users to perfectly implement their plant-specific requirements for each motor feeder
- The SIMOCODE pro system offers functionally graded and space-saving solutions for each customer application
- The replacement of the control circuit hardware with integrated control functions decreases the number of hardware components and wiring required and in this way limits stock keeping costs and potential wiring errors
- The use of electronic full motor protection permits better utilization of the motors and ensures long-term stability of the tripping characteristic and reliable tripping even after years of service
- Thanks to the precision of the current, voltage, power and energy measurements (especially those acquired by the 2nd-generation current/voltage measuring modules), costs can be internally allocated with a high degree of accuracy.
- By virtue of its wide frequency range of 20 to 400 Hz, SIMOCODE can be used in combination with the 2nd-generation current/voltage measuring modules in a wide range of motor applications.

**Multifunctional, electronic full motor protection for rated motor currents up to 820 A**

SIMOCODE pro offers comprehensive protection of the motor feeder by means of a combination of different, multi-step and delayable protection and monitoring functions:

- Inverse-time delayed electronic overload protection (CLASS 5E to 40E)
- Thermistor motor protection
- Phase failure / unbalance protection
- Stall protection
- Monitoring of adjustable limit values for the motor current
- Voltage and power monitoring
- Monitoring of the power factor (motor idling/load shedding)
- Ground-fault monitoring
- Temperature monitoring, e.g. over PT100/PT1000
- Monitoring of operating hours, downtime and number of starts etc.

**Recording of measuring curves**

SIMOCODE pro can record measuring curves and therefore is able, for example, to present the progression of motor current during motor start up.

**Flexible motor control implemented with integrated control functions (instead of comprehensive hardware interlocks)**

Many predefined motor control functions have already been integrated into SIMOCODE pro, including all necessary logic operations and interlocks:

- Overload relays
- Direct-on-line and reversing starters
- Wye/delta starters (also with direction reversal)
- Two speeds, motors with separate windings (pole-changing starter); also with direction reversal
- Two speeds, motors with separate Dahlander windings (also with direction reversal)
- Positioner actuation
- Solenoid valve actuation
- Actuation of a motor starter protector
- Soft starter actuation (also with direction reversal)

These control functions are predefined in SIMOCODE pro and can be freely assigned to the inputs and outputs of the device (including the PROFIBUS/PROFINET process image).

These predefined control functions can also be flexibly adapted to each customized configuration of a motor feeder by means of freely configurable logic modules (truth tables, counters, timers, edge evaluation, etc.) and with the help of standard functions (power failure monitoring, emergency start, external faults, etc.), without additional auxiliary relays being necessary in the control circuit.

SIMOCODE pro makes a lot of additional hardware and wiring in the control circuit unnecessary, which results in a high level of standardization of the motor feeder in terms of its design and circuit diagrams.

## SIMOCODE pro 3UF7

## General data

**Detailed operational, service and diagnostics data**

SIMOCODE pro makes different operational, service and diagnostics data available and helps to detect potential faults in time and to prevent them by means of preventative measures. In the event of a malfunction, a fault can be diagnosed, localized and rectified very quickly - there are no or very short downtimes.

Operating data

- Motor switching state derived from the current flow in the main circuit
- All phase currents
- All phase voltages and phase-to-phase voltages
- Active power, apparent power and power factor
- Phase unbalance and phase sequence
- Ground-fault current
- Frequency
- Time to trip
- Motor temperature
- Remaining cooling time etc.

Service data

- Motor operating hours
- Motor stop times
- Number of motor starts
- Number of overload trips
- Interval for compulsory testing of the enabling circuits
- Energy consumed
- Internal comments stored in the device etc.

Diagnostics data

- Numerous detailed early warning and fault messages
- Internal device fault logging with time stamp
- Time stamping of freely selectable status, alarm or fault messages etc.

**Easy operation and diagnostics**Operator panel

The operator panel is used to control the motor feeder and can replace all conventional pushbuttons and indicator lights to save space. It makes SIMOCODE pro or the feeder directly operable in the control cabinet. It features all the status LEDs available on the basic unit and externalizes the system interface for simple parameterization or diagnosis on a PC/PG.

Operator panel with display

As an alternative to the 3UF720 standard operator panel for SIMOCODE pro V, a 3UF721 operator panel with display is also available. This can additionally indicate current measured values, operational and diagnostics data or status information of the motor feeder at the control cabinet. The pushbuttons of the operator panel can be used to control the motor. Furthermore, it is possible to set parameters such as rated motor current, limit values, etc. directly via the operator panel with display (with SIMOCODE pro V PROFIBUS as of E15, SIMOCODE pro V Modbus RTU as of E02 and with all SIMOCODE pro V PROFINET and EtherNet/IP).

**Communication**

SIMOCODE pro has either an integrated PROFIBUS DP or Modbus RTU interface (SUB-D or terminal connection) or a PROFINET or EtherNet/IP interface (2 x RJ45).

Fail-safe disconnection through PROFIBUS or PROFINET with the PROFIsafe profile is also possible in conjunction with a fail-safe controller (F-CPU) and the DM-F PROFIsafe fail-safe digital module.

SIMOCODE pro PROFIBUS

SIMOCODE pro PROFIBUS supports, for example:

- Cyclic services (DPV0) and acyclic services (DPV1)
- Extensive diagnostics and hardware interrupts
- Time stamp with high timing precision (SIMATIC S7) for SIMOCODE pro V
- DPV1 communication after the Y-Link

SIMOCODE pro PROFINET

SIMOCODE pro PROFINET supports, for example:

- Line and ring bus topology thanks to an integrated switch
- Media redundancy via MRP protocol
- Operating, service and diagnostics data via standard web browser
- OPC UA server for open communication with visualization and control system
- NTP-synchronized time
- Interval function and measured values for energy management via PROFIenergy
- Module exchange without PC memory module through proximity detection
- Extensive diagnostics and maintenance alarms

System redundancy with SIMOCODE pro PROFINET

The device supports the system redundancy mechanisms of PROFINET IO and therefore can be operated directly on fault-tolerant systems such as SIMATIC S7-400 H. As such, SIMOCODE pro can provide decisive added value also for the field level of plants in which plant availability and control system redundancy are priorities.

SIMOCODE pro Modbus RTU

SIMOCODE pro Modbus RTU supports, for example:

- Communication at 1 200/2 400/4 800/9 600/19 200 or 57 600 baud
- Access to freely parameterizable process image via Modbus RTU
- Access to all operating, service and diagnostics data via Modbus RTU

SIMOCODE pro EtherNet/IP

SIMOCODE pro EtherNet/IP supports, for example:

- Line and ring bus topology thanks to an integrated switch
- Ring structures via Device Level Ring (DLR) protocol
- Operating, service and diagnostics data via standard web browser
- NTP-synchronized time
- Parameter assignment via SIMOCODE ES V14 – via local device interface and Ethernet

## SIMOCODE pro 3UF7

## General data

Notes on safety

In order to protect plants, systems, machines and networks against cyber threats, it is necessary to implement (and continuously maintain) a holistic, state-of-the-art industrial security concept. Siemens products and solutions represent only one component of such a concept.

For more information on industrial security, see [www.siemens.com/industrialsecurity](http://www.siemens.com/industrialsecurity).

For SIMOCODE pro motor management and control devices with communication function, see from page 3/73.

Accessories, see from page 3/79.

**Autonomous operation**

An essential feature of SIMOCODE pro is the autonomous execution of all protection and control functions, even when communication to the I&C system is interrupted. This means that even in the event of bus system or automation system failure, full functionality of the feeder is ensured or a specific behavior can be parameterized in case of such a fault, e.g. targeted shutdown of the feeder or execution of particular parameterized control mechanisms (such as reversal of the direction of rotation).

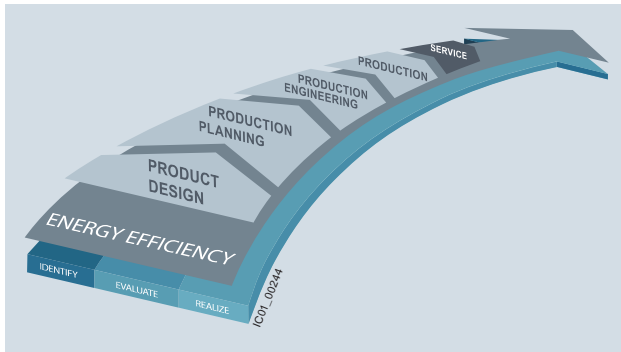
**Advantages through energy efficiency**

Overview of the energy management process

We offer you a unique portfolio for efficient energy management in the industry – a process that is used to optimize the energy requirements. We split up our industrial energy management into three phases – identify, evaluate, and realize – and we support you with the appropriate hardware and software solutions in every process phase.

The innovative SIRIUS industrial controls products can also make a major contribution to the energy efficiency of a plant ([www.siemens.com/sirius/energysaving](http://www.siemens.com/sirius/energysaving)).

The SIMOCODE pro 3UF7 motor management system makes the following contribution to the energy efficiency of the plant as a whole:

- **Energy consumption:**  
Clear display of the energy consumption of a motor feeder or process element by means of the acquisition and transmission of all operating and consumption data, such as current, voltage, active and reactive power, energy consumption, motor temperature, etc.
- **Energy management:**  
Evaluation of measured energy values (e.g. limit value monitoring) with exporting of local or central actions (= forwarding to higher-level)
- **PROFenergy:**  
SIMOCODE pro V PROFINET supports the PROFenergy functions. Reduced energy consumption thanks to automatic disconnection in the intervals and forwarding of the measured values for higher-level energy management systems.

**Advantages from integrated energy management**

[siemens.com/energysuite](http://siemens.com/energysuite)

Ready for  
SIMATIC  
Energy Suite

As an integrated option for the TIA Portal, the SIMATIC Energy Suite couples energy management with automation efficiently, making energy consumption at your production facility transparent.

Thanks to the simplified configuration of energy-measuring components, e.g. SIMOCODE pro V, configuration effort is also clearly reduced.

Thanks to the end-to-end connection with higher-level energy management systems or cloud-based services, you can seamlessly expand the recorded energy data to create a cross-site energy management system.

The advantages at a glance:

- Automatic generation of energy management data
- Integration into TIA Portal and into automation
- Simple configuration

For more information, see [www.siemens.com/energysuite](http://www.siemens.com/energysuite).

## SIMOCODE pro 3UF7

## Technical data

## Application

SIMOCODE pro is often used for automated processes where plant downtimes are very expensive (e.g. chemical, oil/gas, water/wastewater, steel or cement industries) and where it is important to prevent plant downtimes through detailed operational, service and diagnostics data or to locate faults very quickly when they occur.

SIMOCODE pro is modular and space-saving and suited especially for operation in motor control centers (MCCs) in the process industry and for power plant technology.

## Applications

Protection and control of motors in hazardous areas for types of protection EEx e/d according to ATEX guideline 94/9/EC

- With heavy starting (paper, cement, metal and water industries)
- In high-availability plants (chemical, oil, raw material processing industries, power plants)

## Use of SIMOCODE pro 3UF7 with IE3/IE4 motors

## Note:

When using the SIMOCODE pro 3UF7 in conjunction with highly energy-efficient IE3/IE4 motors, please observe the information on dimensioning and configuring; see [Application Manual "SIRIUS Controls with IE3/IE4 motors"](#), <https://support.industry.siemens.com/cs/ww/en/view/94770820>.

## Safety technology for SIMOCODE pro

The safe disconnection of motors in the process industry is becoming increasingly important as the result of new and revised standards and requirements in the safety technology field.

With the DM-F Local and DM-F PROFIsafe fail-safe expansion modules it is easy to integrate functions for fail-safe disconnection into the SIMOCODE pro V motor management system while retaining service-proven concepts. The strict separation of safety functions and operational functions proves particularly advantageous for planning, configuring and construction. Seamless integration in the motor management system leads to greater transparency for diagnostics and during operation of the system.

Suitable components for this purpose are the DM-F Local and DM-F PROFIsafe fail-safe expansion modules, depending on the requirements:

- The DM-F Local fail-safe digital module for when direct assignment between a fail-safe hardware shutdown signal and a motor feeder is required, or
- The DM-F PROFIsafe fail-safe digital module for when a fail-safe controller (F-CPU) creates the signal for disconnection and transmits it in a fail-safe manner through PROFIBUS/PROFIsafe or PROFINET/PROFIsafe to the motor management system

## Technical specifications

More information		
Technical specifications, see <a href="https://support.industry.siemens.com/cs/ww/en/ps/16337/td">https://support.industry.siemens.com/cs/ww/en/ps/16337/td</a>		"SIRIUS Controls with IE3/IE4 motors" Application Manual, see <a href="https://support.industry.siemens.com/cs/ww/en/view/94770820">https://support.industry.siemens.com/cs/ww/en/view/94770820</a>
SIMOCODE pro - Manual Collection see <a href="https://support.industry.siemens.com/cs/ww/en/view/109743951">https://support.industry.siemens.com/cs/ww/en/view/109743951</a>		Selection data for type-tested assemblies/load feeders
"SIMOCODE pro Safety Fail-Safe Digital Modules" System Manual, see <a href="https://support.industry.siemens.com/cs/ww/en/view/50564852">https://support.industry.siemens.com/cs/ww/en/view/50564852</a>		<ul style="list-style-type: none"> <li>• Manual "Configuring SIRIUS", see <a href="https://support.industry.siemens.com/cs/ww/en/view/40625241">https://support.industry.siemens.com/cs/ww/en/view/40625241</a></li> <li>• Manual "Configuring SIRIUS Innovations", see <a href="https://support.industry.siemens.com/cs/ww/en/view/39714188">https://support.industry.siemens.com/cs/ww/en/view/39714188</a></li> </ul>
General data		
Type		<b>3UF7</b>
Permissible ambient temperature		
• During operation	°C	-25 ... +60; 3UF721: 0 ... +60
• During storage and transport	°C	-40 ... +80; 3UF721: -20 ... +70
Degree of protection (acc. to IEC 60529)		
• Measuring modules with busbar connection		IP00
• Operator panel (front) and door adapter (front) with cover		IP54
• Other components		IP20
Shock resistance (sine pulse)	g/ms	15/11
Mounting position		Any
Frequency	Hz	50/60 ± 5 %
EMC interference immunity (according to IEC 60947-1)		
• Conducted interference, burst acc. to IEC 61000-4-4	kV	Corresponds to degree of severity 3
• Conducted interference, high frequency acc. to IEC 61000-4-6	kV	2 (power ports)
• Conducted interference, surge acc. to IEC 61000-4-5	V	1 (signal ports)
• Electrostatic discharge, ESD acc. to IEC 61000-4-2	kV	10
• Field-related interference acc. to IEC 61000-4-3	kV	2 (line to ground); 3UF7320-1AB, 3UF7330-1AB: 1 (line to ground)
	kV	1 (line to line); 3UF7320-1AB, 3UF7330-1AB: 0.5 (line to line)
	kV	8 (air discharge); 3UF7020: operator input during operation only on the front
	kV	6 (contact discharge); 3UF721: 4 (contact discharge)
	V/m	10
EMC emitted interference (according to IEC 60947-1)		
• Conducted and radiated interference emission		EN 55011/EN 55022 (CISPR 11/CISPR 22) (Corresponds to degree of severity A)
Protective separation (acc. to IEC 60947-1)		All circuits in SIMOCODE pro are safely separated from each other according to IEC 60947-1, i.e. they are designed with doubled creepage paths and clearances. In this context, compliance with the instructions in the test report "Safe Isolation" No. 2668 is required.

## SIMOCODE pro 3UF7

## Technical data

Basic units						
Type		3UF7000-1AU00-0, 3UF7010-1AU00-0, 3UF7000-1AB00-0, 3UF7010-1AB00-0, 3UF7011-1AU00-0, 3UF7020-1AU01-0, 3UF7011-1AB00-0, 3UF7020-1AB01-0, 3UF7012-1AU00-0, 3UF7013-1AU00-0, 3UF7012-1AB00-0, 3UF7013-1AB00-0				
<b>Control circuit</b>						
Rated control supply voltage $U_s$ (acc. to IEC 61131-2)		110 ... 240 AC/DC; 50/60 Hz		24 V DC		
<b>Operating range</b>						
• SIMOCODE pro C (3UF7000) and SIMOCODE pro V PROFIBUS (3UF7010) SIMOCODE pro V Modbus RTU (3UF7012)		0.85 ... 1.1 x $U_s$		0.80 ... 1.2 x $U_s$		
• SIMOCODE pro V PROFINET (3UF7011), SIMOCODE pro V EtherNet/IP (3UF7013) and SIMOCODE pro S (3UF7020)		0.85 ... 1.1 x $U_s$		0.80 ... 1.2 x $U_s$		
- Operation		0.85 ... 1.1 x $U_s$		0.85 ... 1.2 x $U_s$		
- Start up		0.85 ... 1.1 x $U_s$		0.85 ... 1.2 x $U_s$		
<b>Power consumption</b>						
• SIMOCODE pro C (3UF7000) and SIMOCODE pro S (3UF7020)		7 VA/5 W		5 W		
• SIMOCODE pro V PROFIBUS (3UF7010) and SIMOCODE pro V Modbus RTU (3UF7012) including two connected expansion modules		10 VA/7 W		7 W		
• SIMOCODE pro V PROFIBUS E15/V 4.0 (3UF7010-1A.00-0 -Z B01), incl. two connected expansion modules		7 VA/5 W		4 W		
• SIMOCODE pro V PROFINET (3UF7011) and SIMOCODE pro V EtherNet/IP (3UF7013), including two connected expansion modules		11 VA/8 W		8 W		
Rated insulation voltage $U_i$	V	300 (at pollution degree 3)				
Rated impulse withstand voltage $U_{imp}$	kV	4				
<b>Relay outputs</b>						
• Number		3 monostable relay outputs				
- SIMOCODE pro C, SIMOCODE pro V		2 monostable relay outputs				
- SIMOCODE pro S						
• Specified short-circuit protection for auxiliary contacts (relay outputs)		6 A operational class gG; 10 A quick-response (IEC 60947-5-1)				
- Fuse links		1.6 A, C characteristic (IEC 60947-5-1); 6 A, C characteristic ( $I_k < 500$ A)				
- Miniature circuit breaker		6				
• Rated uninterrupted current	A					
• Rated switching capacity		6 A/24 V AC      6 A/120 V AC      3 A/230 V AC				
- AC-15		2 A/DC 24 V      0.55 A/DC 60 V      0.25 A/DC 125 V				
- DC-13						
<b>Inputs (binary)</b>		4 inputs supplied internally by the device electronics (with 24 V DC) and connected to a common potential				
<b>Thermistor motor protection (binary PTC)</b>						
• Summation cold resistance	k $\Omega$	$\leq 1.5$				
• Response value	k $\Omega$	3.4 ... 3.8				
• Return value	k $\Omega$	1.5 ... 1.65				
<b>2nd generation current/voltage measuring modules</b>						
Type		3UF7110-1AA01-0	3UF7111-1AA01-0	3UF7112-1AA01-0	3UF7113-1.A01-0	3UF7114-1BA01-0
<b>Main circuit</b>						
Set current $I_e$	A	0.3 ... 4	3 ... +40	10 ... 115	20 ... 200	63 ... 630
Rated insulation voltage $U_i$	V	690				
Rated operational voltage $U_e$	V	690				
Rated impulse withstand voltage $U_{imp}$	kV	6				
Rated frequency	Hz	50/60				
Type of current		Three-phase current				
Short circuit		Additional short-circuit protection is required in the main circuit				
<b>Typical voltage measuring range</b>						
• Phase-to-phase voltage/line-to-line voltage (e.g. $U_{L1L2}$ )	V	110 ... 690				
• Phase voltage (e.g. $U_{L1N}$ )	V	65 ... 400				
<b>Accuracy at 25 °C, 50/60 Hz</b>						
Valid for current range and for voltage range	A	0.25 ... 8	7.5 ... 230	15 ... 400	15 ... 400	47 ... 1260
		• Phase-to-phase voltage $V_L$ in the range 0.85 x 110 V - 1.1 x 690 V				
		• Phase voltage $V_L$ in the range 0.85 x 65 V - 1.1 x 400 V				
• Current measurement	%	1.5				
• Voltage measurement	%	1.5				
• Power factor measurement (p.f. $\geq 0.5$ )	%	1.5				
• Apparent power measurement (p.f. $\geq 0.5$ )	%	3				
• Active power measurement (p.f. $\geq 0.5$ )	%	5				
• Energy measurement (p.f. $\geq 0.5$ )	%	5				
• Frequency measurement (p.f. $\geq 0.5$ )	%	1.5				
<b>Notes on voltage measurement</b>						
• Supply lines for voltage measurement		In the supply lines from the main circuit for voltage measurement of SIMOCODE pro it may be necessary to provide additional line protection!				

## SIMOCODE pro 3UF7

## Technical data

Current measuring modules or current/voltage measuring modules						
Type		3UF7110-1AA00-0	3UF7111-1AA00-0	3UF7112-1AA00-0	3UF7113-1.A00-0	3UF7114-1BA00-0
<b>Main circuit</b>						
Set current $I_e$	A	0.3 ... 3	2.4 ... 25	10 ... 100	20 ... 200	63 ... 630
Rated insulation voltage $U_i$	V	690; 3UF7103 and 3UF7104: 1 000 (at pollution degree 3)				
Rated operational voltage $U_o$	V	690				
Rated impulse withstand voltage $U_{imp}$	kV	6; 3UF7103 and 3UF7104: 8				
Rated frequency	Hz	50/60				
Type of current		Three-phase current				
Short circuit		Additional short-circuit protection is required in the main circuit				
Accuracy of current measurement (in the range of 1 x minimum current setting $I_u$ to 8 x max. current setting $I_o$ )	%	± 3				
<b>Typical voltage measuring range</b>						
• Phase-to-phase voltage/line-to-line voltage (e.g. $U_{L1L2}$ )	V	110 ... 690				
• Phase voltage (e.g. $U_{L1N}$ )	V	65 ... 400				
<b>Accuracy</b>						
• Voltage measurement (phase voltage $U_L$ in the range 230 ... 400 V)	%	± 3 (typical)				
• Power factor measurement (in the rated load range PF (cos $\varphi$ ) = 0.4 ... 0.8)	%	± 5 (typical)				
• Apparent power measurement (in the rated load range)	%	± 5 (typical)				
<b>Notes on voltage measurement</b>						
• In insulated, high-resistance or asymmetrically grounded forms of power supply system and for single-phase systems		In these networks the current/voltage measuring module can be used only with an upstream decoupling module on the system interface.				
• Supply lines for voltage measurement		In the supply lines from the main circuit for voltage measurement of SIMOCODE pro it may be necessary to provide additional line protection!				
Digital modules or multifunction modules						
Type		3UF7300, 3UF7310, 3UF7600				
<b>Control circuit</b>						
Rated insulation voltage $U_i$	V	300 (at pollution degree 3)				
Rated impulse withstand voltage $U_{imp}$	kV	4				
<b>Relay outputs</b>						
• Number		2 monostable or bistable relay outputs (depending on the version)				
• Specified short-circuit protection for auxiliary contacts (relay outputs)		6 A operational class gG; 10 A quick-response (IEC 60947-5-1)				
- Fuse links		1.6 A, C characteristic (IEC 60947-5-1); 6 A, C characteristic ( $I_k < 500$ A)				
- Miniature circuit breaker		6				
• Rated uninterrupted current	A	6				
• Rated switching capacity		6 A/24 V AC      6 A/120 V AC      3 A/230 V AC				
- AC-15		2 A/24 V DC      0.55 A/60 V DC      0.25 A/125 V DC				
- DC-13						
Inputs (binary)		4 inputs, electrically isolated, supplied externally with 24 V DC or 110 ... 240 V AC/DC depending on the version, connected to a common potential				
Ground-fault modules or multifunction modules						
Type		3UF7510, 3UF7600				
<b>Control circuit</b>						
Connectable residual-current transformer		3UL23				
Type of current for monitoring		Type A (AC and pulsating DC residual currents)				
Adjustable response value		30 mA ... 40 A				
Relative measurement error	%	7.5				
Temperature modules or multifunction modules						
Type		3UF7600, 3UF7700				
<b>Sensor circuit</b>						
<b>Number of temperature sensors</b>						
• 3UF7700		3 temperature sensors				
• 3UF7600		1 temperature sensor				
<b>Typical sensor current</b>						
• PT100	mA	1 (typical)				
• PT1000/KTY83/KTY84/NTC	mA	0.2 (typical)				
<b>Open-circuit/short-circuit detection</b>						
• Sensor type		PT100/PT1000	KTY83-110	KTY84	NTC	
- Open circuit		✓	✓	✓	--	
- Short circuit		✓	✓	✓	✓	
- Measuring range	°C	-50 ... +500	-50 ... +175	-40 ... +300	80 ... 160	
Measuring accuracy at 20 °C ambient temperature (T20)	K	< ± 2				
Deviations due to ambient temperature (in % of the measuring range)	%	0.05 per K deviation from T20				
Conversion time	ms	500				
Connection type		Two- or three-wire connection				

✓ Detection possible

-- Detection not possible



## SIMOCODE pro 3UF7

## Technical data

Analog module					
<b>Type</b>		<b>3UF74</b>			
<b>Control circuit</b>					
<b>Inputs</b>					
• Channels		2 (passive)			
• Parameterizable measuring ranges	mA	0/4 ... 20			
• Shielding		Up to 30 m shield recommended, from 30 m shield required			
• Max. input current (destruction limit)	mA	40			
• Accuracy	%	± 1			
• Input resistance	Ω	50			
• Conversion time	ms	150			
• Resolution	Bit	12			
• Open-circuit detection		With measuring range 4 ... 20 mA			
<b>Outputs</b>					
• Channels		1			
• Parameterizable output range	mA	0/4 ... 20			
• Shielding		Up to 30 m shield recommended, from 30 m shield required			
• Max. voltage at output	V DC	30			
• Accuracy	%	± 1			
• Max. output load	Ω	500			
• Conversion time	ms	25			
• Resolution	Bit	12			
• Short-circuit proof		Yes			
<b>Connection type</b>		Two-wire connection			
<b>Electrical separation of inputs/output to the device electronics</b>		No			
Fail-safe digital modules					
<b>Type</b>		<b>3UF7320-1AB00-0</b>	<b>3UF7320-1AU00-0</b>	<b>3UF7330-1AB00-0</b>	<b>3UF7330-1AU00-0</b>
<b>Control circuit</b>					
<b>Rated control supply voltage <math>U_s</math></b>	V	24 DC	110 ... 240 AC/DC; 50/60 Hz	24 DC	110 ... 240 AC/DC; 50/60 Hz
<b>Power consumption</b>		3 CO	9.5 VA/4.5 W	4 W	11 VA/5.5 W
<b>Rated insulation voltage</b>	V	300			
<b>Rated impulse withstand voltage <math>U_{imp}</math></b>	kV	4			
<b>Relay outputs</b>					
• Number		2 relay enabling circuits, 2 relay outputs			
<b>Version of the fuse link</b>	A	4, operational class gG			
For short-circuit protection of the relay enabling circuit					
<b>Rated uninterrupted current</b>	A	5			
<b>Rated switching capacity</b>					
• AC-15		3 A/AC 24 V; 3 A/AC 120 V; 1.5 A/AC 230 V			
• DC-13		4 A/24 V DC; 0.55 A/60 V DC; 0.22 A/125 V DC			
<b>Inputs (binary)</b>		5 (with internal power supply from the device electronics)			
<b>Cable length</b>					
• Between sensor/start signal and evaluation electronics	m	1500			
• For further digital signals	m	300			
<b>Safety data <sup>1)</sup></b>					
<b>SIL level max. according to IEC 61508</b>		3			
<b>Performance level PL according to EN ISO 13849-1</b>		e			
<b>Category according to EN ISO 13849-1</b>		4			
<b>Stop category according to EN 60204-1</b>		0			
<b>Probability of a dangerous failure (at 40 °C) for SIL 3 applications</b>					
• Per hour (PFH <sub>d</sub> ) at a high demand rate according to IEC 62061	1/h	4.5 × 10 <sup>-9</sup>	4.6 × 10 <sup>-9</sup>	4.4 × 10 <sup>-9</sup>	4.4 × 10 <sup>-9</sup>
• On demand (PFD <sub>avg</sub> ) at a low demand rate according to IEC 61508		5.4 × 10 <sup>-6</sup>	5.5 × 10 <sup>-6</sup>	5.1 × 10 <sup>-6</sup>	5.2 × 10 <sup>-6</sup>
<b>T1 value for proof-test interval or service life according to IEC 61508</b>	a	20			

<sup>1)</sup> More safety data, see system manual "SIMOCODE pro Safety Fail-Safe Digital Modules", <https://support.industry.siemens.com/cs/ww/en/view/50564852>.



# SIMOCODE pro 3UF7

## Technical data

### More information

#### Configuration instructions when using an operator panel with display and/or a decoupling module with SIMOCODE pro V with PROFIBUS or Modbus RTU

If you want to use an operator panel with display and/or a decoupling module in the SIMOCODE pro V system with PROFIBUS (product version earlier than E15) or Modbus RTU (product version earlier than E02), configuration instructions concerning the type and number of connectable expansion modules must be observed.

The following tables show the maximum possible configuration of the expansion modules for the various combinations. These are also conveniently stored in the TIA Selection Tool. See [www.siemens.com/tia-selection-tool](http://www.siemens.com/tia-selection-tool).

The DM-F Local and DM-F PROFIsafe fail-safe expansion modules behave in this connection like digital modules for standard applications.

#### Use of an operator panel with display

Digital module 1	Digital module 2	Analog module	Temperature module	Ground-fault module
<b>Only operator panel with display for SIMOCODE pro V (24 V DC or 110 ... 240 V AC/DC)</b>				
Max. four expansion modules can be used				
<b>Operator panel with display and current/voltage measurement with SIMOCODE pro V (110 ... 240 V AC/DC)</b>				
Max. three expansion modules can be used or:				
--	--	✓	✓	--

- ✓ Available
- Not available

#### Use of a decoupling module (voltage measurement in insulated networks)

Digital module 1	Digital module 2	Analog module	Temperature module	Ground-fault module
<b>SIMOCODE pro V (24 V DC)</b>				
✓ <sup>1)</sup>	✓ <sup>1)</sup>	✓	✓	✓
<b>SIMOCODE pro V (110 ... 240 V AC/DC)</b>				
✓	✓	--	✓	✓
✓ <sup>1)</sup>	✓ <sup>1)</sup>	✓	✓	--
✓	--	✓	✓	--
✓	--	✓	--	✓

- ✓ Available
  - Not available
- <sup>1)</sup> No bistable relay outputs and no more than five of seven relay outputs active simultaneously (> 3 s).

Use of a decoupling module (voltage measurement in insulated networks) in combination with an operator panel with display

Digital module 1	Digital module 2	Analog module	Temperature module	Ground-fault module
<b>SIMOCODE pro V (24 V DC)</b>				
✓	--	✓	✓	✓
✓	✓	--	✓	✓
<b>SIMOCODE pro V (110 ... 240 V AC/DC)</b>				
✓ <sup>1)</sup>	--	✓	✓	✓
✓	✓	--	--	--
✓ <sup>2)</sup>	✓ <sup>2)</sup>	✓ <sup>3)</sup>	--	--
✓	--	--	✓	✓

- ✓ Available
  - Not available
- <sup>1)</sup> No bistable relay outputs and no more than three of five relay outputs active simultaneously (> 3 s).
- <sup>2)</sup> No bistable relay outputs and no more than five of seven relay outputs active simultaneously (> 3 s).
- <sup>3)</sup> Analog module output is not used.

#### Configuration instructions for the use of a fail-safe expansion module

Fail-safe digital module	Digital module 2	Analog module	Temperature module	Ground-fault module
<b>DM-F Local</b>				
Max. four expansion modules can be used				
<b>DM-F PROFIsafe</b>				
Max. three expansion modules can be used or:				
✓	✓	✓	✓	--

- ✓ Available
- Not available

#### Protective separation

All circuits in SIMOCODE pro are safely isolated from each other in accordance with IEC 60947-1. That is, they are designed with double creepages and clearances. In the event of a fault, therefore, no parasitic voltages can be formed in neighboring circuits. The instructions of Test log No. 2668 must be complied with.

#### Types of protection EEx e and EEx d

The overload protection and the thermistor motor protection of the SIMOCODE pro system comply with the requirements for overload protection of explosion-proof motors to the type of protection:





- EEx d "flameproof enclosure" e.g. according to IEC 60079-1
- EEx e "increased safety" e.g. according to IEC 60079-7

When using SIMOCODE pro devices with a 24 V DC control voltage, electrical separation must be ensured using a battery or a safety transformer according to IEC 61558-2-6. EC type-examination certificate BVS 06 ATEX F 001 Test report: BVS PP 05.2029 EG.

# SIMOCODE pro 3UF7

Basic units IE3/IE4 ready

## Selection and ordering data

Version	SD	Screw terminals 	PU (UNIT, SET, M)	PS*
	d	Article No.	Price per PU	
<b>SIMOCODE pro PROFIBUS</b>				
 3UF7000-1A.00-0	<b>SIMOCODE pro C</b> PROFIBUS DP interface, 12 Mbps, RS 485 4 I/3 O freely assignable, input for thermistor connection, monostable relay outputs Rated control supply voltage $U_s$ : • 24 V DC • 110 ... 240 V AC/DC	▶ 3UF7000-1AB00-0 ▶ 3UF7000-1AU00-0	1 1 unit 1 1 unit	
	<b>SIMOCODE pro S<sup>1)</sup></b> PROFIBUS DP interface, 1.5 Mbps, RS 485 4 I/2 O freely assignable, input for thermistor connection, monostable relay outputs, can be expanded by a multifunction module Rated control supply voltage $U_s$ : • 24 V DC • 110 ... 240 V AC/DC	▶ 3UF7020-1AB01-0 ▶ 3UF7020-1AU01-0	1 1 unit 1 1 unit	
 3UF7010-1A.00-0	<b>SIMOCODE pro V<sup>2)</sup></b> PROFIBUS DP interface, 12 Mbps, RS 485 4 I/3 O freely assignable, input for thermistor connection, monostable relay outputs, can be expanded by expansion modules Rated control supply voltage $U_s$ : • 24 V DC • 110 ... 240 V AC/DC	▶ 3UF7010-1AB00-0 ▶ 3UF7010-1AU00-0	1 1 unit 1 1 unit	
	<b>SIMOCODE pro PROFINET</b>			
 3UF7011-1A.00-0	<b>SIMOCODE pro V PROFINET</b> ETHERNET/PROFINET IO, OPC UA server and web server, 100 Mbps, 2 x connection to bus through RJ45, PROFINET system redundancy, media redundancy protocol, 4 I/3 O freely assignable, input for thermistor connection, monostable relay outputs, can be expanded by expansion modules, web server in German/English/Chinese/Russian Rated control supply voltage $U_s$ : • 24 V DC • 110 ... 240 V AC/DC	▶ 3UF7011-1AB00-0 ▶ 3UF7011-1AU00-0	1 1 unit 1 1 unit	





<sup>1)</sup> The connection cable to the current measuring module must be at least 30 cm.

<sup>2)</sup> For the use of 2nd-generation current/voltage measuring modules, SIMOCODE pro V PROFIBUS with product version E15 (V 4.0) must be ordered. This version does not have marine certification or CCC approval and can be ordered at no extra charge. The article number must be supplemented by "-Z" and the order code "B01", e.g. 3UF7010-1A.00-0 -Z B01.

# SIMOCODE pro 3UF7

Basic units IE3/IE4 ready

OVERLOAD RELAYS

Version	SD	Screw terminals	⊕	PU (UNIT, SET, M)	PS*																		
	d	Article No.	Price per PU																				
<b>SIMOCODE pro Modbus RTU</b>																							
 <p><b>SIMOCODE pro V Modbus RTU<sup>1)</sup></b>                      Modbus RTU interface, 57.6 kbp, RS485, 4 I/3 O freely parameterizable, input for thermistor connection, monostable relay outputs, can be expanded using expansion modules                      Rated control supply voltage <math>U_s</math>:                      • 24 V DC                      • 110 ... 240 V AC/DC</p>																							
		3UF7012-1A00-0		1	1 unit																		
				1	1 unit																		
<b>SIMOCODE pro EtherNet/IP <i>NEW</i></b>																							
 <p><b>SIMOCODE pro V EtherNet/IP<sup>1)</sup></b>                      EtherNet/IP interface, web server, 100 Mbps, 2 x connection to bus through RJ45, media redundancy DLR, 4 I/3 O freely parameterizable, input for thermistor connection, monostable relay outputs, can be expanded using expansion modules, web server in German/English/Chinese/Russian                      Rated control supply voltage <math>U_s</math>:                      • 24 V DC                      • 110 ... 240 V AC/DC</p>																							
		3UF7013-1A00-0		1	1 unit																		
				1	1 unit																		
<b>SIMOCODE pro current or current/voltage measuring modules</b>																							
 <p><b>Current measuring modules</b></p> <ul style="list-style-type: none"> <li>• Straight-through transformers                             <table border="0"> <tr><td>0.3 ... 3</td><td>45</td><td>▶</td></tr> <tr><td>2.4 ... 25</td><td>45</td><td>▶</td></tr> <tr><td>10 ... 100</td><td>55</td><td>▶</td></tr> <tr><td>20 ... 200</td><td>120</td><td>▶</td></tr> </table> </li> <li>• Bus connections                             <table border="0"> <tr><td>20 ... 200</td><td>120</td><td>▶</td></tr> <tr><td>63 ... 630</td><td>145</td><td>▶</td></tr> </table> </li> </ul>	0.3 ... 3	45	▶	2.4 ... 25	45	▶	10 ... 100	55	▶	20 ... 200	120	▶	20 ... 200	120	▶	63 ... 630	145	▶					
	0.3 ... 3	45	▶																				
	2.4 ... 25	45	▶																				
	10 ... 100	55	▶																				
	20 ... 200	120	▶																				
	20 ... 200	120	▶																				
	63 ... 630	145	▶																				
		3UF7100-1AA00-0		1	1 unit																		
				1	1 unit																		
				1	1 unit																		
				1	1 unit																		
				1	1 unit																		
				1	1 unit																		
 <p><b>2nd generation current/voltage measuring modules for SIMOCODE pro V<sup>1)</sup> <i>NEW</i></b>                      Voltage measurement up to 690 V, measured values with increased accuracy, power, power factor and active current monitoring</p> <ul style="list-style-type: none"> <li>• Straight-through transformers                             <table border="0"> <tr><td>0.3 ... 4</td><td>45</td><td>▶</td></tr> <tr><td>3 ... +40</td><td>45</td><td>▶</td></tr> <tr><td>10 ... 115</td><td>55</td><td>▶</td></tr> <tr><td>20 ... 200</td><td>120</td><td>▶</td></tr> </table> </li> <li>• Bus connections                             <table border="0"> <tr><td>20 ... 200</td><td>120</td><td>▶</td></tr> <tr><td>63 ... 630</td><td>145</td><td>▶</td></tr> </table> </li> </ul>	0.3 ... 4	45	▶	3 ... +40	45	▶	10 ... 115	55	▶	20 ... 200	120	▶	20 ... 200	120	▶	63 ... 630	145	▶					
	0.3 ... 4	45	▶																				
	3 ... +40	45	▶																				
	10 ... 115	55	▶																				
	20 ... 200	120	▶																				
	20 ... 200	120	▶																				
	63 ... 630	145	▶																				
		3UF7110-1AA01-0		1	1 unit																		
				1	1 unit																		
				1	1 unit																		
				1	1 unit																		
				1	1 unit																		
				1	1 unit																		
 <p><b>Current/voltage measuring modules for SIMOCODE pro V</b>                      Voltage measurement up to 690 V                      If required in connection with a decoupling module</p> <ul style="list-style-type: none"> <li>• Straight-through transformers                             <table border="0"> <tr><td>0.3 ... 3</td><td>45</td><td>▶</td></tr> <tr><td>2.4 ... 25</td><td>45</td><td>▶</td></tr> <tr><td>10 ... 100</td><td>55</td><td>▶</td></tr> <tr><td>20 ... 200</td><td>120</td><td>▶</td></tr> </table> </li> <li>• Bus connections                             <table border="0"> <tr><td>20 ... 200</td><td>120</td><td>▶</td></tr> <tr><td>63 ... 630</td><td>145</td><td>▶</td></tr> </table> </li> </ul>	0.3 ... 3	45	▶	2.4 ... 25	45	▶	10 ... 100	55	▶	20 ... 200	120	▶	20 ... 200	120	▶	63 ... 630	145	▶					
	0.3 ... 3	45	▶																				
	2.4 ... 25	45	▶																				
	10 ... 100	55	▶																				
	20 ... 200	120	▶																				
	20 ... 200	120	▶																				
	63 ... 630	145	▶																				
		3UF7110-1AA00-0		1	1 unit																		
				1	1 unit																		
				1	1 unit																		
				1	1 unit																		
				1	1 unit																		
				1	1 unit																		

<sup>1)</sup> The SIMOCODE ES (TIA Portal) V14 software is necessary for parameterization, see page 3/82.

**Note:**

SIMOCODE pro V basic unit in a hardened version via SIPLUS extreme upon request.

# SIMOCODE pro 3UF7

Basic units IE3/IE4 ready

Version	Current setting	Width	SD	Screw terminals	⊕	PU (UNIT, SET, M)	PS*
	A	mm	d	Article No.	Price per PU		
<b>SIMOCODE pro decoupling modules</b>							
	<b>Decoupling module</b>						
For connecting upstream from a current/voltage measuring module on the system interface when using voltage detection in insulated, high-resistance or asymmetrically grounded systems and in single-phase systems				2	<b>3UF7150-1AA00-0</b>	1	1 unit
3UF7150-1AA00-0							
<b>SIMOCODE pro operator panels</b>							
<b>Operator panels</b>							
Installation in control cabinet door or front plate, for plugging into all SIMOCODE pro basic units, ten LEDs for status indication and user-assignable buttons for controlling the motor							
	• Titanium gray			▶	<b>3UF7200-1AA01-0</b>	1	1 unit
3UF7200-1AA01-0							
	• Light gray			▶	<b>3UF7200-1AA00-0</b>	1	1 unit
3UF7200-1AA00-0							
<b>Operator panels for SIMOCODE pro V</b>							
Installation in control cabinet door or front plate, for plugging into SIMOCODE pro V and SIMOCODE pro V PN, seven LEDs for status indication and user-assignable buttons for controlling the motor, multilingual display, e.g. for indication of measured values, status information or fault messages							
	• Titanium gray <b>NEW</b>			▶	<b>3UF7210-1AA01-0</b>	1	1 unit
- English/German/French/Spanish/Portuguese/Italian/Polish/Finnish				▶	<b>3UF7210-1BA01-0</b>	1	1 unit
- English/Chinese/Russian/Korean							
3UF7210-1.A01-0							
	• Light gray			▶	<b>3UF7210-1AA00-0</b>	1	1 unit
- English/German/French/Spanish/Portuguese/Italian/Polish/Finnish				▶	<b>3UF7210-1BA00-0</b>	1	1 unit
- English/Chinese/Russian/Korean							
3UF7210-1.A00-0							

# SIMOCODE pro 3UF7

## Fail-safe expansion modules

### Selection and ordering data

Version	SD	<b>Screw terminals</b>		PU (UNIT, SET, M)	PS*
	d	Article No.	Price per PU		

#### Expansion modules for SIMOCODE pro V

With SIMOCODE pro V, it is possible to expand the type and number of inputs and outputs in steps. Each expansion module has two system interfaces on the front. Through the one system interface the expansion module is connected to the system interface of the SIMOCODE pro V using a connection cable; through the second system interface, further expansion modules or the operator panel can be connected. The power supply for the expansion modules is provided by the connection cable through the basic unit.

**Note:**

Please order connection cable separately, [see page 3/79](#).

#### Digital modules

Up to two digital modules can be used to add additional binary inputs and relay outputs to the basic unit. The input circuits of the digital modules are supplied from an external power supply.

Four binary inputs and two relay outputs  
Up to two digital modules can be connected

Relay outputs	Input voltage			
Monostable	24 V DC	▶	<b>3UF7300-1AB00-0</b>	1 1 unit
	110 ... 240 V AC/DC	▶	<b>3UF7300-1AU00-0</b>	1 1 unit
Bistable	24 V DC	▶	<b>3UF7310-1AB00-0</b>	1 1 unit
	110 ... 240 V AC/DC	▶	<b>3UF7310-1AU00-0</b>	1 1 unit



3UF7300-1AU00-0

#### Analog module

By means of the analog module, the basic unit can be optionally expanded with analog inputs and outputs (0/4 ... 20 mA).

Two inputs (passive) for input and one output for output of 0/4 ... 20 mA signals, max. one analog module can be connected per pro V basic unit and max. two analog modules per pro V PN basic unit

▶ **3UF7400-1AA00-0** 1 1 unit



3UF7400-1AA00-0

#### Ground-fault modules<sup>1)</sup>

Ground-fault monitoring using 3UL23 residual-current transformers and ground-fault modules is used in cases where precise detection of the ground-fault current is required or power systems with high impedance are grounded.

With the ground-fault module, it is possible to determine the precise fault current as a measured value, and to define freely selectable warning and trip limits in a wide range from 30 mA ... 40 A.

One input for connecting a 3UL23 residual-current transformer, up to one ground-fault module can be connected

▶ **3UF7510-1AA00-0** 1 1 unit

**Note:**

For corresponding residual-current transformers, [see page 11/66 or Industry Mall](#).



3UF7510-1AA00-0

#### Temperature modules

Irrespective of the thermistor motor protection of the basic units, an additional max. three analog temperature sensors can be evaluated using a temperature module.

Sensor types: PT100/PT1000, KTY83/KTY84 or NTC

Three inputs for connecting up to three analog temperature sensors, up to one temperature module can be connected per pro V basic unit and up to two temperature modules per pro V PN basic unit

▶ **3UF7700-1AA00-0** 1 1 unit



3UF7700-1AA00-0

<sup>1)</sup> Possible with pro V PROFIBUS basic unit from product version E10, pro V PROFINET basic unit from product version E04, all pro V Modbus RTU or EtherNet/IP basic units.

# SIMOCODE pro 3UF7

## Accessories

Version	SD	Screw terminals 	PU (UNIT, SET, M)	PS*
	d	Article No.	Price per PU	

### Expansion modules for SIMOCODE pro S

With SIMOCODE pro S, it is possible to expand the type and number of inputs and outputs. The expansion module has two system interfaces on the front. Through the one system interface the expansion module is connected to the system interface of the SIMOCODE pro S using a connection cable; through the second system interface, the operator panel can be connected. The power supply for the expansion module is provided by the connection cable through the basic unit.

**Note:**

Please order connection cable separately, [see page 3/79](#).

#### Multifunction modules

The multifunction module is the expansion module of the SIMOCODE pro S device series with the following functions:

- Digital module function with four digital inputs and two monostable relay outputs
- Ground-fault module function with an input for the connection of a 3UL23 residual-current transformer with freely selectable warning and trip limits in a wide zone of 30 mA ... 40 A
- Temperature module function with an input for connecting an analog temperature sensor PT100, PT1000, KTY83, KTY84, or NTC

Max. one multifunction module can be connected per pro S basic unit

Input voltage of the digital inputs:

- 24 V DC
- 110 ... 240 V AC/DC

▶	<b>3UF7600-1AB01-0</b>	1	1 unit
▶	<b>3UF7600-1AU01-0</b>	1	1 unit



3UF7600-1AU01-0

# SIMOCODE pro 3UF7

## Fail-safe expansion modules

### Selection and ordering data

Version	SD	<b>Screw terminals</b>		PU (UNIT, SET, M)	PS*
	d	Article No.	Price per PU		

#### Fail-safe expansion modules for SIMOCODE pro V

Thanks to the fail-safe expansion modules, SIMOCODE pro V can be expanded with the function of a safety relay for the fail-safe disconnection of motors. A maximum of one fail-safe digital module can be connected; it can be used instead of a digital module.

The fail-safe expansion modules are equipped likewise with two system interfaces at the front for making the connection to other system components. Unlike other expansion modules, power is supplied to the modules through a separate terminal connection.

Note:

Please order connection cable separately, [see page 3/79](#).

#### DM-F Local fail-safe digital modules

For fail-safe disconnection using a hardware signal  
Two relay enabling circuits, joint switching; two relay outputs, common potential disconnected fail-safe; inputs for sensor circuit, start signal, cascading and feedback circuit, safety function adjustable using DIP switches  
Rated control supply voltage  $U_s$ :

- 24 V DC
- 110 ... 240 V AC/DC

- ▶ **3UF7320-1AB00-0**
- ▶ **3UF7320-1AU00-0**

- 1 1 unit
- 1 1 unit

#### DM-F PROFI-safe fail-safe digital modules<sup>1)</sup>

For fail-safe disconnection using PROFIBUS/PROFI-safe or PROFINET/PROFI-safe  
Two relay enabling circuits, joint switching; two relay outputs, common potential disconnected fail-safe; one input for feedback circuit; three binary standard inputs  
Rated control supply voltage  $U_s$ :

- 24 V DC
- 110 ... 240 V AC/DC

- ▶ **3UF7330-1AB00-0**
- ▶ **3UF7330-1AU00-0**

- 1 1 unit
- 1 1 unit



3UF7320-1AB00-0



3UF7330-1AB00-0

<sup>1)</sup> Cannot be used in conjunction with SIMOCODE pro V for Modbus RTU or EtherNet/IP communication.









# SIMOCODE pro 3UF7

## Accessories







3 OVERLOAD RELAYS

### Selection and ordering data

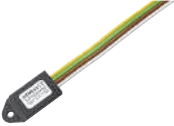
Version	SD	Article No.	Price per PU	PU (UNIT, SET, M)	PS*
<b>Connection cables (essential accessory)</b>					
In different lengths for connecting basic unit, current measuring module, current/voltage measuring module, operator panel or expansion modules or decoupling module					
					
3UF7932-0AA00-0					
Version	Length				
Flat	0.025 m	▶ 3UF7930-0AA00-0		1	1 unit
Flat	0.1 m	▶▶ 3UF7931-0AA00-0		1	1 unit
Flat	0.3 m	▶▶▶ 3UF7935-0AA00-0		1	1 unit
Flat	0.5 m	▶▶▶▶ 3UF7932-0AA00-0		1	1 unit
Round	0.5 m	▶▶▶▶▶ 3UF7932-0BA00-0		1	1 unit
Round	1.0 m	▶▶▶▶▶▶ 3UF7937-0BA00-0		1	1 unit
Round	2.5 m	▶▶▶▶▶▶▶ 3UF7933-0BA00-0		1	1 unit
<b>PC cables and adapters</b>					
	<b>USB PC cables</b>	▶	3UF7941-0AA00-0	1	1 unit
3UF7941-0AA00-0	For connecting to the USB interface of a PC/PG, for communication with SIMOCODE pro through the system interface				
	<b>USB/serial adapters</b>	5	3UF7946-0AA00-0	1	1 unit
	To connect an RS 232 PC cable to the USB interface of a PC, recommended for use in conjunction with SIMOCODE pro 3UF7				
<b>Memory modules</b>					
	Enable transmission to a new system, e.g. when a device is replaced, without the need for additional aids or detailed knowledge of the device.				
	<b>Memory module for SIMOCODE pro C</b>	▶	3UF7900-0AA00-0	1	1 unit
	For saving the complete parameterization of a SIMOCODE pro C system				
	<b>Memory module for SIMOCODE pro S and SIMOCODE pro V</b>				
	For saving the complete parameterization of a SIMOCODE pro system				
	• Titanium gray <b>NEW</b>	▶	3UF7901-0AA01-0	1	1 unit
3UF7901-0AA01-0					
	• Light gray	▶	3UF7901-0AA00-0	1	1 unit
3UF7901-0AA00-0					
<b>Interface covers</b>					
	For system interface				
	• Titanium gray	10	3RA6936-0B	1	5 units
3RA6936-0B					
	• Light gray	▶	3UF7950-0AA00-0	1	5 units
3UF7950-0AA00-0					
<b>Addressing plugs</b>					
	For assigning the PROFIBUS or Modbus RTU address without using a PC/PG to SIMOCODE pro through the system interface				
3UF7910-0AA00-0		▶	3UF7910-0AA00-0	1	1 unit





# SIMOCODE pro 3UF7

## Accessories

Version	SD	Article No.	Price per PU	PU (UNIT, SET, M)	PS*																							
<b>Accessories for motor control centers</b>																												
<p>With the draw-out technology often used in motor control centers it is possible to integrate a SIMOCODE pro initialization module in the switchboard on a permanent basis. Feeder-related parameter and address data can then be permanently assigned to this feeder.</p>																												
 <p>3UF7902-0AA00-0</p>	<p><b>Initialization module</b></p> <p>For automatic parameterization of SIMOCODE pro S and SIMOCODE pro V basic units (pro V PROFIBUS basic units from product version E09)</p>	▶ <b>3UF7902-0AA00-0</b>		1	1 unit																							
	<p><b>Y connection cable</b></p> <p>For use in conjunction with the initialization module; connects the basic unit, current measuring module or current/voltage measuring module, and initialization module</p> <table border="1"> <thead> <tr> <th>System interface length</th> <th>Open cable end</th> <th></th> <th></th> <th></th> <th></th> </tr> </thead> <tbody> <tr> <td>0.1 m</td> <td>1.0 m</td> <td>▶</td> <td><b>3UF7931-0CA00-0</b></td> <td>1</td> <td>1 unit</td> </tr> <tr> <td>0.5 m</td> <td>1.0 m</td> <td>▶▶</td> <td><b>3UF7932-0CA00-0</b></td> <td>1</td> <td>1 unit</td> </tr> <tr> <td>1.0 m</td> <td>1.0 m</td> <td>▶▶▶</td> <td><b>3UF7937-0CA00-0</b></td> <td>1</td> <td>1 unit</td> </tr> </tbody> </table>					System interface length	Open cable end					0.1 m	1.0 m	▶	<b>3UF7931-0CA00-0</b>	1	1 unit	0.5 m	1.0 m	▶▶	<b>3UF7932-0CA00-0</b>	1	1 unit	1.0 m	1.0 m	▶▶▶	<b>3UF7937-0CA00-0</b>	1
System interface length	Open cable end																											
0.1 m	1.0 m	▶	<b>3UF7931-0CA00-0</b>	1	1 unit																							
0.5 m	1.0 m	▶▶	<b>3UF7932-0CA00-0</b>	1	1 unit																							
1.0 m	1.0 m	▶▶▶	<b>3UF7937-0CA00-0</b>	1	1 unit																							
<b>Bus connection terminals</b>																												
 <p>3UF7960-0AA00-0</p>	<p>For shield support and strain relief of the PROFIBUS cable on a SIMOCODE pro S</p>	▶ <b>3UF7960-0AA00-0</b>		1	1 unit																							
	<p><b>Door adapters</b></p> <p>For external connection of the system interface, e.g. outside a control cabinet</p>																											
 <p>3UF7920-0AA00-0</p>	▶ <b>3UF7920-0AA00-0</b>		1	1 unit																								
<b>Adapters for operator panel</b>																												
 <p>3UF7922-0AA00-0</p>	<p>The adapter enables the smaller 3UF7200 operator panel from SIMOCODE pro to be used in a front panel cutout in which previously, e.g. after a change of system, a larger 3UF52 operator panel from SIMOCODE-DP had been used, degree of protection IP54</p>	▶ <b>3UF7922-0AA00-0</b>		1	1 unit																							
<b>Labeling strips</b>																												
 <p>3UF7925-0AA02-0</p>	<ul style="list-style-type: none"> <li>For pushbuttons of the 3UF720 operator panel</li> </ul>	▶ <b>3UF7925-0AA00-0</b>		100	400 units																							
	<ul style="list-style-type: none"> <li>For pushbuttons of the 3UF721 operator panel with display</li> </ul>	▶ <b>3UF7925-0AA01-0</b>		100	600 units																							
	<ul style="list-style-type: none"> <li>For LEDs of the 3UF720 operator panel</li> </ul>	▶ <b>3UF7925-0AA02-0</b>		100	1200 units																							
<b>Push-in lugs</b>																												
 <p>3RV2928-0B</p>	<p>For screw fixing, e.g. on mounting plate, two units required per device</p> <ul style="list-style-type: none"> <li>Can be used for 3UF71.0, 3UF71.1 and 3UF71.2</li> </ul>	2 <b>3RV2928-0B</b>		100	10 units																							
	<ul style="list-style-type: none"> <li>Can be used for 3UF700, 3UF701, 3UF73, 3UF74, 3UF75 and 3UF77</li> </ul>	5 <b>3RP1903</b>		1	10 units																							
	<ul style="list-style-type: none"> <li>Can be used for 3UF7020, 3UF7600</li> </ul>	2 <b>3ZY1311-0AA00</b>		1	10 units																							

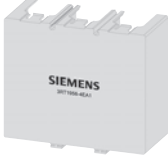
# SIMOCODE pro 3UF7

## Accessories

Version	SD	Article No.	Price per PU	PU (UNIT, SET, M)	PS*
<b>Terminal covers</b>					
<b>Covers for cable lugs and busbar connections</b>					
 <p>3RT1956-4EA1</p>	<ul style="list-style-type: none"> <li>Length 100 mm, can be used for 3UF71.3-1BA0.-0</li> </ul>	▶ <b>3RT1956-4EA1</b>		1	1 unit
	<ul style="list-style-type: none"> <li>Length 120 mm, can be used for 3UF71.4-1BA0.-0</li> </ul>	▶ <b>3RT1966-4EA1</b>		1	1 unit
<b>Covers for box terminals</b>					
 <p>3RT1956-4EA2</p>	<ul style="list-style-type: none"> <li>Length 25 mm, can be used for 3UF71.3-1BA0.-0</li> </ul>	▶ <b>3RT1956-4EA2</b>		1	1 unit
	<ul style="list-style-type: none"> <li>Length 30 mm, can be used for 3UF71.4-1BA0.-0</li> </ul>	▶ <b>3RT1966-4EA2</b>		1	1 unit
<b>Covers for screw terminals</b>					
Between contactor and current measuring module or current/voltage measuring module for direct mounting					
 <p>3RT1956-4EA2</p>	<ul style="list-style-type: none"> <li>Can be used for 3UF71.3-1BA0.-0</li> </ul>	▶ <b>3RT1956-4EA3</b>		1	1 unit
	<ul style="list-style-type: none"> <li>Can be used for 3UF71.4-1BA0.-0</li> </ul>	▶ <b>3RT1966-4EA3</b>		1	1 unit
<b>Box terminal blocks</b>					
For round and ribbon cables					
 <p>3RT195.-4G</p>	<ul style="list-style-type: none"> <li>Up to 70 mm<sup>2</sup>, can be used for 3UF71.3-1BA0.-0</li> </ul>	▶ <b>3RT1955-4G</b>		1	1 unit
	<ul style="list-style-type: none"> <li>Up to 120 mm<sup>2</sup>, can be used for 3UF71.3-1BA0.-0</li> </ul>	▶ <b>3RT1956-4G</b>		1	1 unit
	<ul style="list-style-type: none"> <li>Up to 240 mm<sup>2</sup>, can be used for 3UF71.4-1BA0.-0</li> </ul>	▶ <b>3RT1966-4G</b>		1	1 unit
<b>Bus termination modules</b>					
With separate control supply voltage for bus termination following the last unit on the bus line					
Supply voltage:					
 <p>3UF1900-1KA00</p>	<ul style="list-style-type: none"> <li>115/230 V AC</li> </ul>	5 <b>3UF1900-1KA00</b>		1	1 unit
	<ul style="list-style-type: none"> <li>24 V DC</li> </ul>	5 <b>3UF1900-1KB00</b>		1	1 unit

## SIMOCODE pro 3UF7

## SIMOCODE ES (TIA Portal)

## Selection and ordering data

## Parameterization and service software for SIMOCODE pro 3UF7

- Delivered without PC cable

Version	SD	Article No.	Price per PU	PU (UNIT, SET, M)	PS*
	d				

## SIMOCODE ES V14 Basic

**Floating license for one user**

Engineering software, software and documentation on DVD, 6 languages (English/German/French/Italian/Spanish/Chinese), combo license for parallel use of versions 2007 and V14 of SIRIUS ES, for all SIMOCODE pro, online functions via system interface

- License key on USB flash drive, Class A
- License key download, Class A

3ZS1322-4CC12-0YA5

▶ 3ZS1322-4CC12-0YA5

1 1 unit

▶ 3ZS1322-4CE12-0YB5

1 1 unit

## SIMOCODE ES V14 Standard

**Floating license for one user**

Engineering software, software and documentation on DVD, 6 languages (English/German/French/Italian/Spanish/Chinese), combo license for parallel use of versions 2007 and V14 of SIRIUS ES, for all SIMOCODE pro, online functions via system interface, parameterizing with the integrated graphics editor (CFC-based)

- License key on USB flash drive, Class A
- License key download, Class A

3ZS1322-5CC12-0YA5

▶ 3ZS1322-5CC12-0YA5

1 1 unit

▶ 3ZS1322-5CE12-0YB5

1 1 unit

**Upgrade for SIMOCODE ES 2007**

2

▶ 3ZS1322-5CC12-0YE5

1 1 unit

Floating license for one user, engineering software, software and documentation on DVD, license key on USB flash drive, Class A 6 languages (English/German/French/Italian/Spanish/Chinese), combo license for parallel use of versions 2007 and V14 of SIRIUS ES, for all SIMOCODE pro, online functions via system interface, parameterizing with the integrated graphics editor (CFC-based)

**Powerpack for SIMOCODE ES V14 Basic**

2

▶ 3ZS1322-5CC12-0YD5

1 1 unit

Floating license for one user, engineering software, license key on USB flash drive, Class A 6 languages (English/German/French/Italian/Spanish/Chinese), for all SIMOCODE pro, online functions via system interface, parameterizing with the integrated graphics editor (CFC-based)

**Software Update Service**

▶

▶ 3ZS1322-5CC12-0YL5

1 1 unit

For 1 year with automatic extension, requires software version of SIMOCODE ES (TIA Portal), engineering software, software and documentation on DVD, online functions via system interface, parameterizing with the integrated graphics editor (CFC-based)

Notes:

SIMOCODE ES V13 licenses can also be used for SIMOCODE ES V14.

# SIMOCODE pro 3UF7

## SIMOCODE ES (TIA Portal)

Version	SD	Article No.	Price per PU	PU (UNIT, SET, M)	PS*
---------	----	-------------	--------------	-------------------	-----

### SIMOCODE ES V14 Premium



3ZS1322-6CC12-0YA5

#### Floating license for one user

Engineering software, software and documentation on DVD, 6 languages (English/German/French/Italian/Spanish/Chinese), combo license for parallel use of versions 2007 and V14 of SIRIUS ES, for all SIMOCODE pro, online functions via system interface and PROFIBUS/PROFINET/Ethernet/IP, parameterizing with the integrated graphics editor (CFC-based)

- License key on USB flash drive, Class A ▶
- License key download, Class A ▶

<b>3ZS1322-6CC12-0YA5</b>	1	1 unit
<b>3ZS1322-6CE12-0YB5</b>	1	1 unit

#### Upgrade for SIMOCODE ES 2007

2

Floating license for one user, engineering software, software and documentation on DVD, license key on USB flash drive, Class A 6 languages (English/German/French/Italian/Spanish/Chinese), combo license for parallel use of versions 2007 and V14 of SIRIUS ES, for all SIMOCODE pro, online functions via system interface and PROFIBUS/PROFINET/EtherNet/IP, parameterizing with the integrated graphics editor (CFC-based)

<b>3ZS1322-6CC12-0YE5</b>	1	1 unit
---------------------------	---	--------

#### Powerpack for SIMOCODE ES V14 Standard

2

Floating license for one user, engineering software, license key on USB flash drive, Class A 6 languages (English/German/French/Italian/Spanish/Chinese), for all SIMOCODE pro, online functions via system interface and PROFIBUS/PROFINET/EtherNet/IP, parameterizing with the integrated graphics editor (CFC-based)

<b>3ZS1322-6CC12-0YD5</b>	1	1 unit
---------------------------	---	--------

#### Software Update Service

▶

For 1 year with automatic extension, requires software version of SIMOCODE ES (TIA Portal), engineering software, software and documentation on DVD, online functions via system interface and PROFIBUS/PROFINET/EtherNet/IP, parameterizing with the integrated graphics editor (CFC-based)

<b>3ZS1322-6CC12-0YL5</b>	1	1 unit
---------------------------	---	--------

### SIMOCODE ES V14 software download

#### Trial license, Class A

▶

Engineering software, 6 languages (English/German/French/Italian/Spanish/Chinese), for all SIMOCODE pro, online functions via system interface and PROFIBUS/PROFINET/EtherNet/IP, parameterizing with the integrated graphics editor (CFC-based)

<b>3ZS1322-6CE12-0YG8</b>	1	1 unit
---------------------------	---	--------

3

OVERLOAD RELAYS

# SIMOCODE pro 3UF7

## SIMOCODE pro block library for SIMATIC PCS 7

### Selection and ordering data

Version	SD	Article No.	Price per PU	PU (UNIT, SET, M)	PS*
	d				

#### SIMOCODE pro block library for SIMATIC PCS 7 Version V8 with Advanced Process Library (APL)



3ZS1632-1XX02-0YA0

#### Engineering software V8

For one engineering station (single license) including runtime software for execution of the AS modules in an automation system (single license), English/German

Scope of supply:  
AS blocks and faceplates for integrating SIMOCODE pro into the PCS 7 process control system with Advanced Process Library, for PCS 7 version V8.0, V8.1 and V8.2

Type of delivery:  
software and documentation on CD,  
one license for one engineering station  
one license for one automation station

▶ **3ZS1632-1XX02-0YA0** 1 1 unit

#### Runtime license V8

For execution of the AS modules in an automation system (single license)  
Required for using the AS modules of the engineering software V8 within a plant

Type of delivery:  
one license for one automation station,  
without software and documentation

▶ **3ZS1632-2XX02-0YB0** 1 1 unit

# SIMOCODE pro 3UF7

## SIMOCODE pro block library for SIMATIC PCS 7

Version	SD	Article No.	Price per PU	PU (UNIT, SET, M)	PS*
---------	----	-------------	--------------	-------------------	-----

**SIMOCODE pro block library for SIMATIC PCS 7 version V7 without Advanced Process Library (APL)**



3UF7982-0AA10-0

<p><b>Engineering software V7</b></p> <p>For one engineering station (single license) including runtime software for execution of the AS modules in an automation system (single license), English/German/French</p> <p>Scope of supply: AS modules and faceplates for integrating SIMOCODE pro into the PCS 7 process control system, for PCS 7 version V7.0/V7.1</p> <p>Type of delivery: software and documentation on CD, one license for one engineering station one license for one automation station</p>	▶	<b>3UF7982-0AA10-0</b>		1	1 unit
<p><b>Runtime license V7</b></p> <p>For execution of the AS modules in an automation system (single license)</p> <p>Required for using the AS modules of the engineering software V7 or the engineering software migration V7-V8 on an additional automation system within a plant</p> <p>Type of delivery: one license for one automation station, without software and documentation</p>	▶	<b>3UF7982-0AA11-0</b>		1	1 unit
<p><b>Upgrade for PCS 7 block library SIMOCODE pro, V6.0 or V6.1 to version SIMOCODE pro V7.0/V7.1</b></p> <p>For one engineering station (single license) including runtime software for execution of the AS modules in an automation system (single license), English/German/French</p> <p>Scope of supply: AS modules and faceplates for integrating SIMOCODE pro into the PCS 7 process control system, for PCS 7 version V7.0 or V7.1</p> <p>Type of delivery: software and documentation on CD, one license for one engineering station one license for one automation station</p>	2	<b>3UF7982-0AA13-0</b>		1	1 unit
<p><b>Engineering software migration V7-V8</b></p> <p>For upgrading (migrating) an existing engineering software V7 of the SIMOCODE pro block library for PCS 7</p> <p>Conditions of use: availability of the engineering software V7 (license) of the SIMOCODE pro block library for PCS 7 for the PCS 7 version V7.0 or V7.1</p> <p>Engineering software migration V7-V8 can be installed directly onto a system with PCS 7 version V8; installation of the previous version is unnecessary.</p> <p>For one engineering station (single license) including runtime software for execution of the AS modules in an automation system (single license), English/German/French</p> <p>Scope of supply: AS blocks and faceplates for integrating SIMOCODE pro into the PCS 7 process control system, for PCS 7 version V8.0 and higher</p> <p>Type of delivery: software and documentation on CD, license for upgrading an existing license for one engineering station and the associated runtime licenses of a plant</p>	▶	<b>3UF7982-0AA20-0</b>		1	1 unit