

Slim Relay G2RV

Industrial Slim Relay Rated at 6 Amps

- Large plug-in terminals for reliable connection.
- LED indicator, clear case, and mechanical flag allows easy and immediate visual operation verification.
- Has a maximum switching voltage of 440 VAC.
- Slim outline to save space in high volume rack and PLC applications.
- Low power consumption for system energy savings.

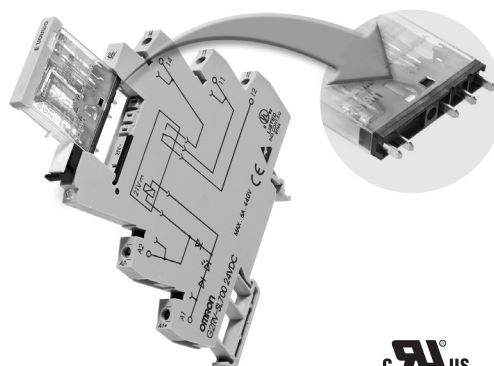

Model Number Structure

Model Number Legend

G2RV-SL □□□ - □
1 2 3 4 5

1. Auxiliary Type Designation

SL: Slim relay and socket combination

2. Wire Connection

- 7: Screw terminals
- 5: Push-in terminals

3. Relay LED

0: Without LED

4. Relay Pushbutton

0: Without pushbutton

5. Input Voltage

(Complete part numbers listed in the Relay and Socket Combinations Chart below)

Note: LED indicator standard feature on Socket.

Ordering Information

List of Models

Classification		Enclosure rating	Input voltage	Type of connection	Contact form
					SPDT
Plug-in terminals	General-purpose	Unsealed	AC/DC	Screw terminals	G2RV-SL700
				Push-in terminals	G2RV-SL500

Relay and Socket Combinations

Input voltage	Screw terminals	Push-in terminals
12 VDC	G2RV-SL700-DC12(DC11)	G2RV-SL500-DC12(DC11)
24 VDC	G2RV-SL700-DC24(DC21)	G2RV-SL500-DC24(DC21)
24 VAC/DC	G2RV-SL700-AC/DC24	G2RV-SL500-AC/DC24
48 VAC/DC	G2RV-SL700-AC/DC48	G2RV-SL500-AC/DC48
110 VAC	G2RV-SL700-AC110	G2RV-SL500-AC110
230 VAC	G2RV-SL700-AC230	G2RV-SL500-AC230



Note: Relay and Socket Combinations are cUL_{US} listed.

Specifications

■ Coil Ratings @ 23°C

Rated voltage	Rated current		Operate voltage	Release voltage	Power consumption		Input voltage	
	AC				% of rated voltage	AC (VA) Approx.		DC (mW) Approx.
	50 Hz	60 Hz	DC	% of rated voltage				
12 VDC	---	---	80% max.	10% min.	---	300 mW	±10%	
24 VDC	---	---			---	300 mW		
24 VAC/DC	21.1	22.5			13.0	0.5 VA		300 mW
48 VAC/DC	8.5	9.0			5.2	0.4 VA		250 mW
110 VAC	7.1	7.5			---	0.8 VA		---
230 VAC	7.3	7.9			---	1.7 VA		---

■ Contact Ratings

Number of poles	1 pole	
Load	Resistive load (cos φ = 1)	Inductive load (cos φ = 0.4, L/R = 7 ms)
Rated load	6 A at 250 VAC; 6 A at 30 VDC	2.5 A at 250 VAC; 2 A at 30 VDC
Rated carry current	6 A	
Max. switching voltage	400 VAC, 125 VDC	
Max. switching current	6 A	
Max. switching power	1,500 VA 180 W	500 VA 60 W
Minimum permissible load	10 mA at 5 VDC : P level: λ ₆₀ = 0.1 x 10 ⁻⁶ /operation	

■ Characteristics

Item	1 pole
Contact resistance	100 mΩ max.
Operate (set) time	20 ms max.
Release time	40 ms max.
Max. operating frequency	Mechanical: 18,000 operations/hr Electrical: 1,800 operations/hr (under rated load)
Insulation resistance	1,000 MΩ min. (at 500 VDC)
Dielectric strength	4,000 VAC, 50/60 Hz for 1 min between coil and contacts 1,000 VAC, 50/60 Hz for 1 min between contacts of same polarity
Vibration resistance	Destruction: 10 to 55 Hz, 1.0 mm double amplitude Malfunction: 10 to 55 Hz, 1.0 mm double amplitude
Shock resistance	Destruction: 1,000 m/s ² (approx. 100G) Malfunction: 200 m/s ² (approx. 20G) when energized; 100 m/s ² (approx. 10G) when not energized
Life expectancy	Mechanical: 5,000,000 operations min. Electrical: 100,000 typical; NO 70,000 operations min.; NC 50,000 operations min.
Ambient temperature	Operating: -40°C to 55°C (with no icing or condensation)
Ambient humidity	Operating: 5% to 85%
Weight	Approx. 35 g
Overvoltage category	III
Pollution degree	2
Contact Material	AgSnIn
Creepage distance	7.0 mm
Clearance distance	5.5 mm

Note: Data shown are of initial values.

■ Approved Standards

UL Recognized (File No. E41643) - - Ambient Temp. = 40°C

Model	Contact form	Coil ratings	Contact ratings	Operations
G2RV-SL Series	SPDT	12 to 48 VDC 24 to 230 VAC	250 VAC 6 A (Resistive Load) 30 VDC 6 A (Resistive Load) 400 VAC 2 A (Resistive Load)	6,000

IEC/VDE (EN 61810)

Contact form	Coil ratings	Contact ratings	Operations
1 pole	12, 24 VDC 24, 48 VAC/DC 110, 230 VAC	250 VAC 6 A (Res.) 30 VDC 6 A (Res.) 400 VAC 2 A (Res.)	50,000 50,000 6,000

Engineering Data

Endurance

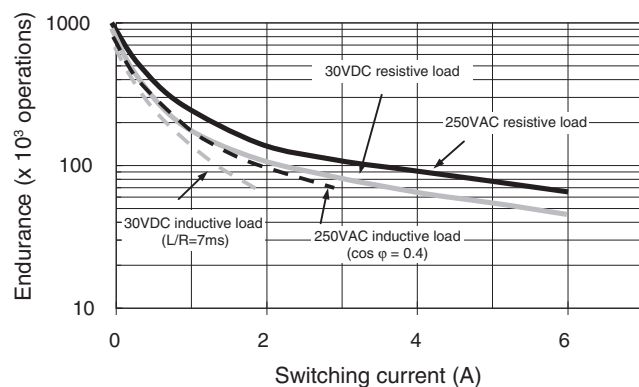

Switching Capacity, DC Resistive Load

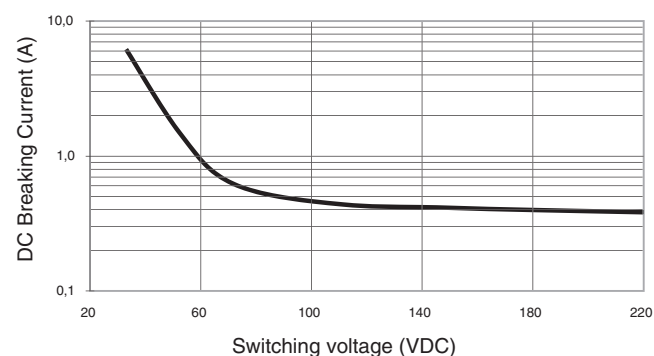

Switching Timing

Model number	Operating time (typical)	Release time (typical)
G2RV-SL7□□/5□□ DC12	5 ~ 7 ms	5 ~ 8 ms
G2RV-SL7□□/5□□ DC24	5 ~ 7 ms	6 ~ 9 ms
G2RV-SL7□□/5□□ AC/DC24	5 ~ 7 ms	17 ~ 22ms
G2RV-SL7□□/5□□ AC/DC48	5 ~ 7 ms	22 ~ 30 ms
G2RV-SL7□□/5□□ AC110	12 ~ 15 ms	22 ~ 30 ms
G2RV-SL7□□/5□□ AC230	12 ~ 15 ms	22 ~ 30 ms

Accessories

■ PLC Interface (for G2RV-SL700 series only)

List of Models

Model number	Description	Connection
P2RVC-8-O-F	PLC Output Interface for 8x G2RV-SL700 series. PnP-type	Flat cable (Ribbon cable connector, 10 pole, IEC603/1)

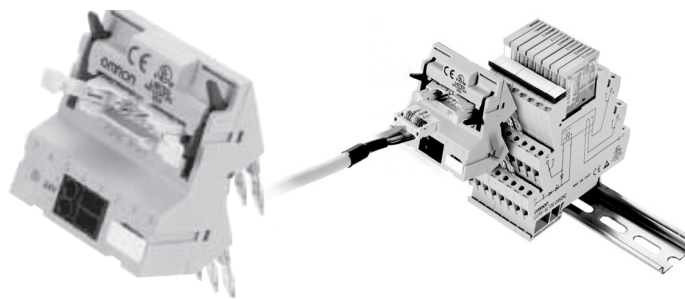

Specifications

Input	Rated voltage	30 VAC/VDC max.
	Current capacity	0.5 A per channel 2.0 A total current, power supply terminal
Characteristics	Ambient temperature	Operating: 0 to 55°C Storage: -20 to 85°C
	Overvoltage category	III
	Pollution degree	2

Electrical schematic P2RVC-8-O-F

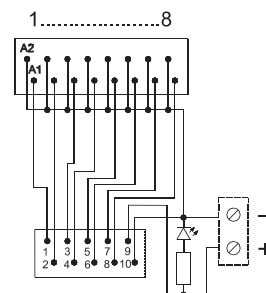

■ Cables for PLC Interface P2RVC-8-O-F

P2RV-4-□□□C

Cable to connect CJ1 to 4 x P2RVC-8-O-F

List of Models

Model number	Cable length
P2RV-4-100C	1.0 m
P2RV-4-200C	2.0 m
P2RV-4-300C	3.0 m
P2RV-4-500C	5.0 m

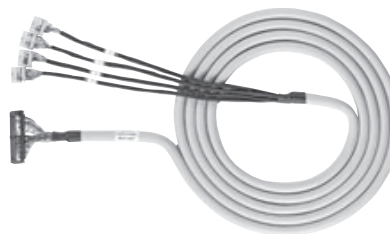

4x10 pole IDC mounting to 4 x P2RVC-8-O-F

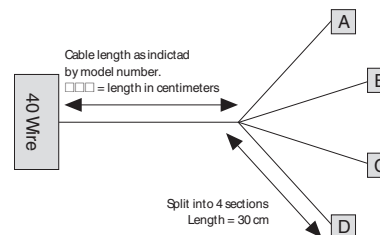
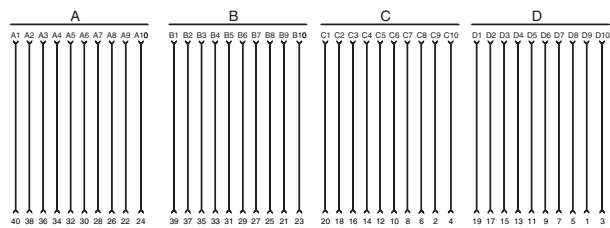

40 pole IDC mounting to Omron PLC CJ1-OD232

Technical data

Control line	AWG26/0.14 mm ² , tin-plated copper
Diameter cable	10.6 mm (one end splits into 4 sections: A, B, C, D)
Operating voltage	60 VDC
Continuous current per signal wire	0.5 A
Max. total current, 4 bytes, each	1.0 A
Test voltage	0.5 KV, 50 Hz, 1 min
Operating temperature range	-20°C to +50°C

P2RV-A□□□C

Cable, single sided 10 pole IDC connector, to connect to P2RVC-8-O-F

List of Models

Model number	Cable length
P2RV-A100C	1.0 m
P2RV-A200C	2.0 m
P2RV-A300C	3.0 m
P2RV-A500C	5.0 m

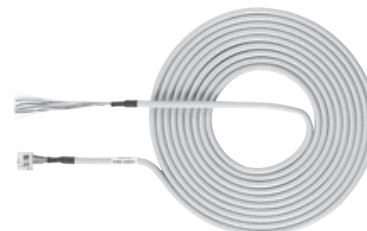

10 pole IDC mounting to P2RVC-8-O-F

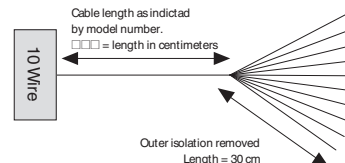

Technical data

Control line	AWG26/0.14 mm ² , tin-plated copper
Diameter cable	6.8 mm
Operating voltage	60 VDC
Continuous current per signal wire	0.5 A
Max. total current	1.0 A
Test voltage	0.5 KV, 50 Hz, 1 min
Operating temperature range	-20°C to +50°C

■ Stand-Alone Relays for MRO and Reference

Model Number Legend

G2RV-□ - □□□ DC□
 1 2 3 4 5

1. Number of Poles

1: 1 pole

2. Terminals

S: Plug-In

3. Relay LED

Blank: Without LED

4. Contact Material

Blank: AgSnIn

5. Rated Coil Voltage

11, 21, 48

List of Models

Model number	Replacement for
G2RV-1-S DC11	G2RV-SL7□□/5□□ DC12(DC11)
G2RV-1-S DC21	G2RV-SL7□□/5□□ DC24(DC21)
	G2RV-SL7□□/5□□ AC/DC24
G2RV-1-S DC48	G2RV-SL7□□/5□□ AC/DC48
	G2RV-SL7□□/5□□ AC110
	G2RV-SL7□□/5□□ AC230



Accessories (Order Separately)

■ Cross Bars

Model Number Legend

P2RVM-□□
1 2

1. Number of Poles

- 020: 2 poles
- 030: 3 poles
- 040: 4 poles
- 100: 10 poles
- 200: 20 poles

2. Color

- R:Red
- S:Blue
- B:Black

Model number	Poles	Color
P2RVM-020□	2	Red (R) Blue (S) Black (B)
P2RVM-030□	3	
P2RVM-040□	4	
P2RVM-100□	10	
P2RVM-200□	20	

Specification	Value
Max. current (EN60947-7-1 section 8.33 / 1991)	32 A
Max. voltage	400 VAC
Max. voltage (when cutting cross-bar without using separation plate or end bracket)	250 VAC

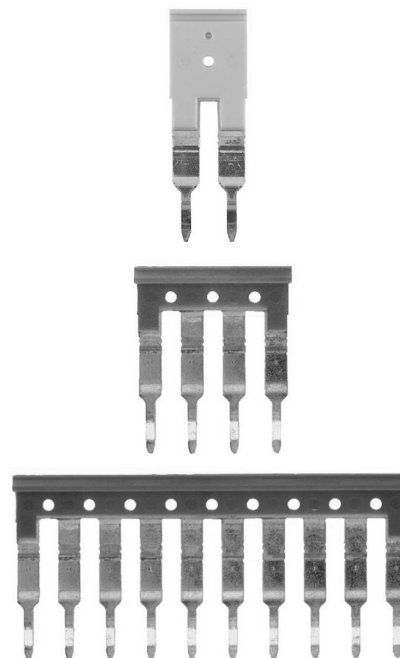

■ Plastic Labels for G2RV Sockets

Model number	Quantity	Color
R99-15 for G2RV	5 sheets x 120 labels = 600 labels (minimum order)	White

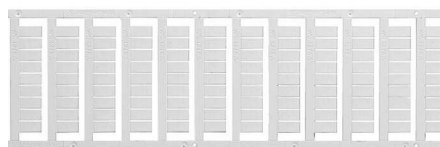

■ Labels (Stickers) for G2RV Sockets

Model number	Quantity	Color
R99-16 for G2RV	10 sheets x 484 labels = 4,840 labels (minimum order)	White

■ Separating Plates

Model number	Quantity	Description
P2RV-S	50 plates (minimum order)	Provides isolation between adjacent relays to achieve 400 V isolation.

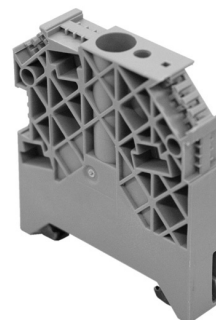

Dimensions

Note: All units are in millimeters unless otherwise indicated.

Complete Unit

G2RV-SL700

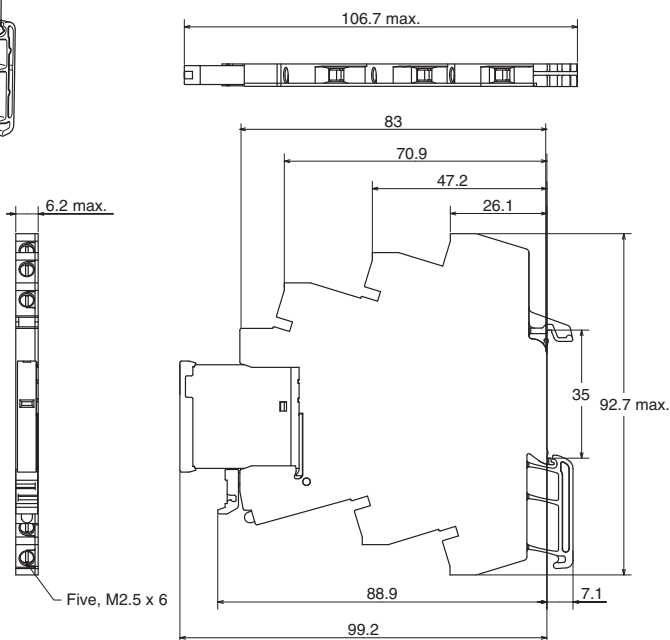
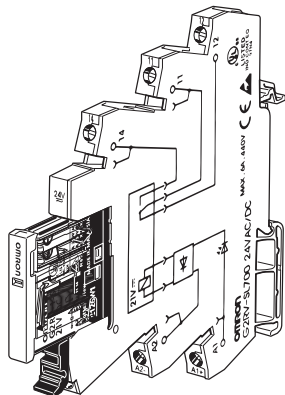

Input circuit

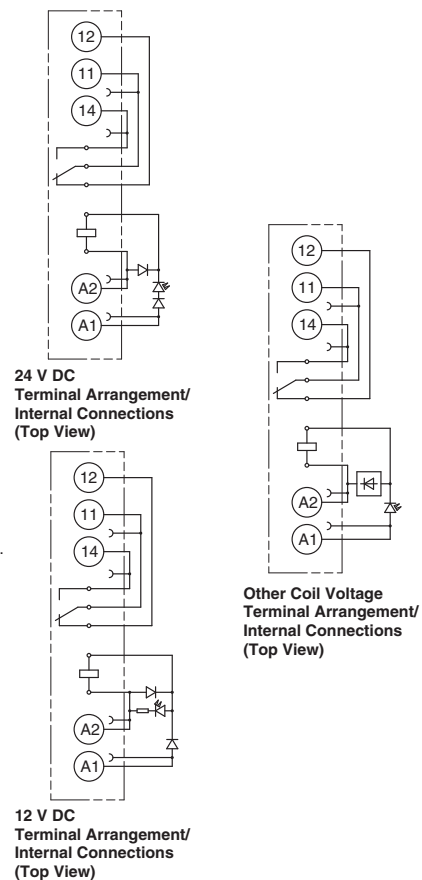

G2RV-SL500

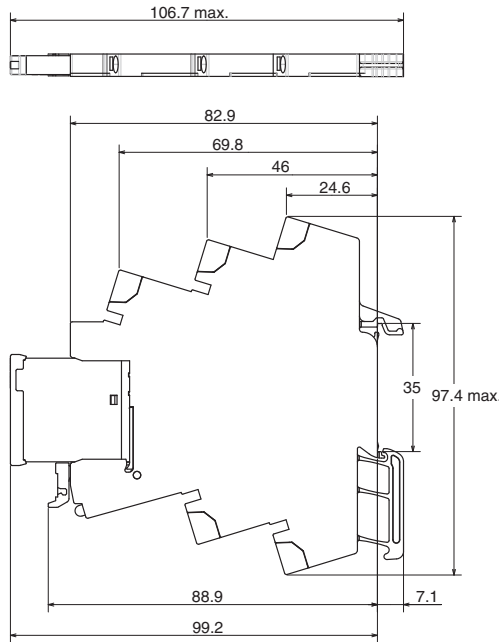
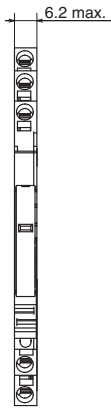
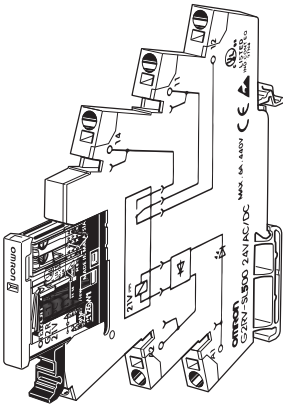

Input circuit

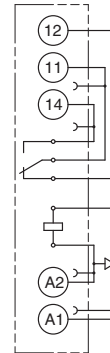

24 V DC Terminal Arrangement/ Internal Connections (Top View)

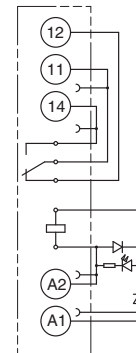

12 V DC Terminal Arrangement/ Internal Connections

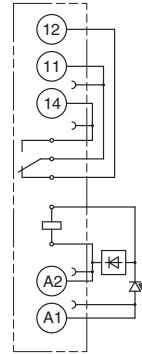

Other Coil Voltage Terminal Arrangement/ Internal Connections (Top View)

■ **Single Relay**

G2RV-1-S

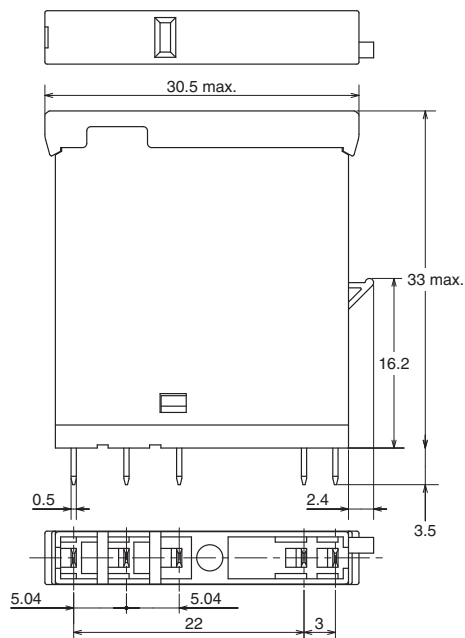
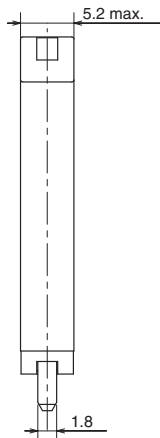
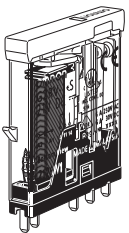

Input circuit

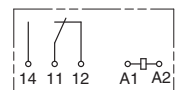

Terminal Arrangement/ Internal Connections (Bottom View)

Installation

Tools

G2RV-SL700 series: Flat-blade screwdriver should be used for mounting and / or releasing cables.

G2RV-SL500 series: Flat-bade screwdriver should be used for mounting stranded wires without ferrules and / or releasing cables.

Applicable Screwdriver

- Flat-blade, Parallel-tip, 2.5 mm diameter (3.0 mm max.)

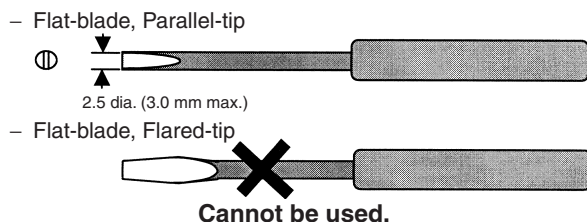

Examples: FACOM AEF2.5x75E (AEF. 3x75E)
 VESSEL No. 9900(-)2.5x75 (No. 9900(-)3x100)
 WAGO 210-119
 WIHA 260/2.5x40 (260/3x50)

*Chamfering the tip of the driver improves insertion when used as an exclusive tool.

Applicable Wires

Applicable Wire Sizes

G2RV-SL700 Series

Box Clamp Technology

Wire type	Applicable Wire Size	Stripping Length
Stranded without ferrules	0.5 - 2.5 mm ²	7 mm
Stranded with ferrules and plastic collar	0.5 - 2.5 mm ²	7 mm
Stranded with ferrules without plastic collar	0.5 - 2.5 mm ²	7 mm
Solid	0.5 - 2.5 mm ²	7 mm

G2RV-SL500 Series

Push-in Technology

Wire type	Applicable Wire Size	Stripping Length
Stranded without ferrules	0.5 - 2.5 mm ²	12 mm
Stranded with ferrules and plastic collar	0.5 - 2.5 mm ²	12 mm
Stranded with ferrules without plastic collar	0.5 - 2.5 mm ²	12 mm
Solid	0.5 - 2.5 mm ²	12 mm

Wiring

Use wires of the applicable sizes specified above. The length of the exposed conductor should be 7 mm for a G2RV-SL700 series, 12 mm for a G2RV-SL500 series.

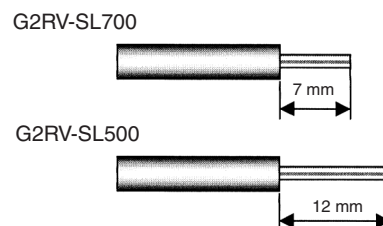

Fig. 1 Exposed Conductor Length

Precautions

■ Precautions for Connection

- Do not move the screwdriver up, down, or from side to side while it is inserted in the hole. Doing so may cause damage to internal components (e.g., deformation of the clamp spring or cracks in the housing) or cause deterioration of insulation.
- Do not insert the screwdriver at an angle. Doing so may break the side of socket and result in a short-circuit.
- Do not insert two or more wires in the hole. Wires may come in contact with the spring causing a temperature rise or be subject to sparks. (There are two wiring holes for each terminal.)
- Insert the screwdriver along the hole wall as shown below.
- If lubricating liquid, such as oil, is present on the tip of screwdriver, the screwdriver may fall out resulting in injury to the operator.
- Insert the screwdriver into the bottom of the hole. It may not be possible to connect cables properly if the screwdriver is inserted incorrectly.

■ General Precautions

- Do not use the product if it has been dropped on the ground. Dropping the product may adversely affect performance.
- Confirm that the socket is securely attached to the mounting track before wiring. If the socket is mounted insecurely it may fall and injure the operator.
- Insure that the socket is not charged during wiring and maintenance. Not doing so may result in electric shock.
- Do not pour water or cleansing agents on the product. Doing so may result in electric shock.
- Do not use the socket in locations subject to solvents or alkaline chemicals.
- Do not use the socket in locations subject to ultraviolet light (e.g., direct sunlight). Doing so may result in markings fading, rust, corrosion, or resin deterioration.
- Do not dispose of the product in fire.

■ Removing from Mounting Rail

To remove the socket from the mounting rail, insert the tip of screwdriver in the fixture rail, and move it in the direction shown on the right.



■ Wiring Procedure for G2RV-SL500 series

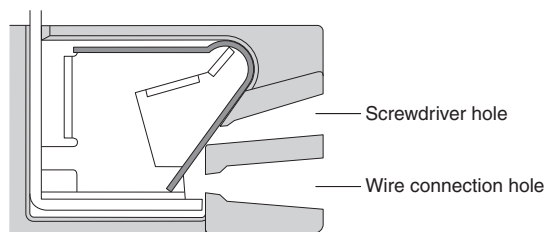

Wire insertion

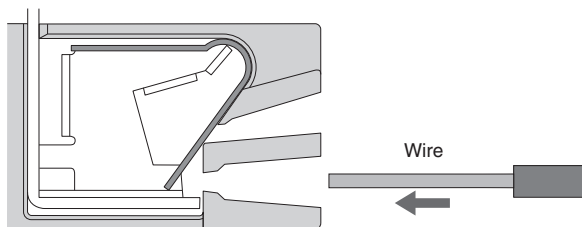

Insert the exposed conductor into the connection hole.

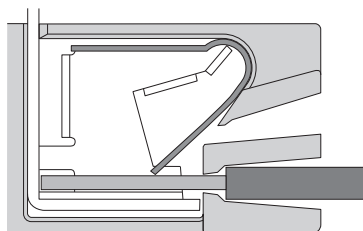

No other tools are required.

Note: In case of wiring stranded wires without ferrules screwdriver should be inserted before inserting the wire. Screwdriver should be removed after fully insertion of the wire.

Wire removal

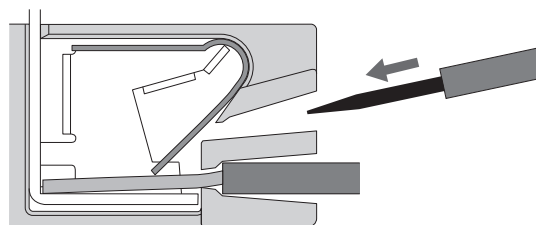

Insert the specified screwdriver into the release hole.

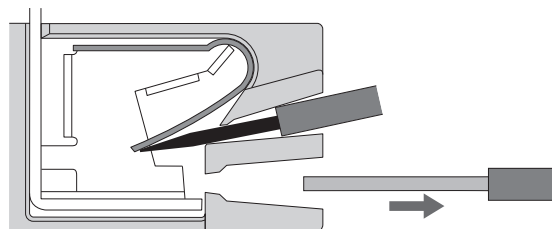

Removing wire.

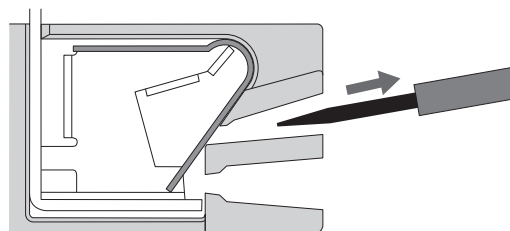

Removing screwdriver.

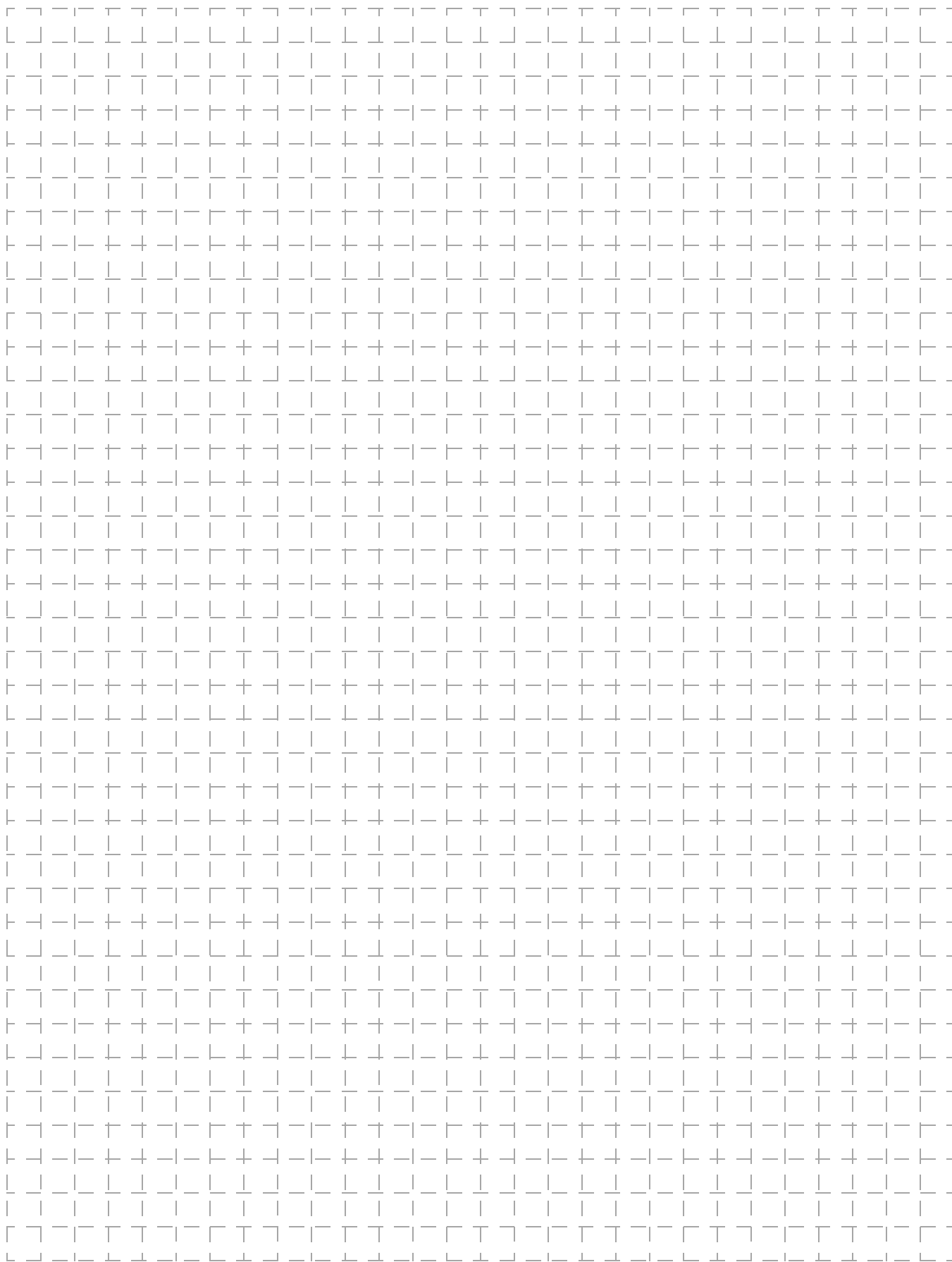

All sales are subject to Omron Electronic Components LLC standard terms and conditions of sale, which can be found at http://www.components.omron.com/components/web/webfiles.nsf/sales_terms.html

ALL DIMENSIONS SHOWN ARE IN MILLIMETERS.

To convert millimeters into inches, multiply by 0.03937. To convert grams into ounces, multiply by 0.03527.

OMRON[®]

**OMRON ELECTRONIC
COMPONENTS LLC**

55 E. Commerce Drive, Suite B
Schaumburg, IL 60173

847-882-2288

OMRON ON-LINE

Global - <http://www.omron.com>

USA - <http://www.components.omron.com>

Cat. No. X301-E-1b

09/11

Specifications subject to change without notice

Printed in USA

Mouser Electronics

Authorized Distributor

Click to View Pricing, Inventory, Delivery & Lifecycle Information:

Omron:

[G2RV-1-S DC21](#) [G2RV-1-S DC48](#) [G2RV-1-S DC11](#) [G2RV-SL700-AP AC230](#) [G2RV-SL500-AP DC12](#) [G2RV-SL500-AP AC230](#) [G2RV-SL500-AP DC24](#) [G2RV-SL500-AP AC110](#) [G2RV-SL500-AP AC/DC24](#) [G2RV-SL700-AP DC12](#) [G2RV-SL700-AP AC110](#) [G2RV-SL500-AP AC/DC48](#) [G2RV-SL700-AP AC/DC48](#) [G2RV-SL700-AP AC/DC24](#) [G2RV-SL700-AP DC24](#) [G2RV-SL700-AC/DC48](#) [G2RV-SL700-DC12](#) [G2RV-SL700 AC230](#) [G2RV-SL500 DC24\(DC21\)](#) [G2RV-SL500 AC/DC48](#) [G2RV-SL700-DC24](#) [G2RV-SL500 AC110](#) [G2RV-SL700-AC110](#) [G2RV-SL500 DC12\(DC11\)](#) [G2RV-SL700-AC/DC24](#) [G2RV-SL500 AC230](#) [G2RV-SL500 AC/DC24](#) [G2RV-1-S-AP DC11](#) [G2RV-1-S-AP DC48](#) [G2RV-1-S-AP DC21](#) [G2RV-SL700 DC12\(DC11\)](#) [G2RV-SL700 DC24\(DC21\)](#)