

## 2 Way Power Divider SMA Interface from 350 MHz to 6 GHz Rated at 30 Watts

FMDV1053 is a passive 2 way RF Power Divider with 50 ohm SMA female connectors operating from .35 to 6 GHz, with a max input power of 30 watts. The FMDV1053 has less than 20 dB Isolation, 0.8 dB Maximum Insertion loss and a Max VSWR of 1.4:1; along with a phase balance of  $\pm 3$  degrees and an amplitude balance of  $\pm 0.2$  dB. The RF Divider operates in a temperature range from  $-45^{\circ}\text{C}$  to  $85^{\circ}\text{C}$  and is rated for Humidity, Shock, Vibration, and Altitude. Power dividers have many applications and so perform many valuable functions within the RF/Microwave world. Examples are antenna beam forming, taps for cable distributed systems combining feeds to and from antennae.



### Electrical Specifications

Design			Wilkinson	
Number of Output Ports			2	
Description	Min	Typ	Max	Units
Frequency Range	0.35		6	GHz
Impedance		50		Ohms
Input VSWR		1.3:1	1.4:1	
Insertion Loss		0.6	0.8	dB
Isolation	18	20		dB
Amplitude Balance		$\pm 0.1$	$\pm 0.2$	dB
Phase Balance		$\pm 2$	$\pm 3$	Degrees
Input Power (CW)			30	Watts
Reverse Power (CW)			2	Watts
Input Power (Peak)			300	Watts

### Mechanical Specifications

<b>Size</b>	
Length	1.81 in [45.97 mm]
Width	0.79 in [20.07 mm]
Height	7.64 in [194.06 mm]
Weight	0.1915 lbs [86.86 g]
Finish	Gray
Housing Material and Plating	Aluminum
<b>Configuration</b>	
Package Type	Connectorized
Input Connector	SMA Female
Output Connectors	SMA Female

### Environmental Specifications

<b>Temperature</b>	
Operating Range	$-45$ to $+85$ deg C
Storage Range	$-55$ to $+125$ deg C
Humidity	100% RH at $35^{\circ}\text{C}$ , 95% RH at $40^{\circ}\text{C}$

### Features:

- Ultra Wide Band Operation
- 30 watt CW Rating
- 350 MHz to 6 GHz
- SMA Female Connector
- Meets Standards for Humidity, Shock, Vibration, Altitude

### Applications:

- Communications Systems
- Amplifier Systems
- Amplifier Power Dividing
- Aerospace/Aviation
- Defense Applications

Fairview Microwave  
 301 Leora Ln., Suite 100  
 Lewisville, TX 75056  
 Tel: 1-800-715-4396 / (972) 649-6678  
 Fax: (972) 649-6689  
[www.fairviewmicrowave.com](http://www.fairviewmicrowave.com)  
[sales@fairviewmicrowave.com](mailto:sales@fairviewmicrowave.com)

Shock  
Vibration  
Altitude

20G for 11msec half sine wave, 3 axis both directions  
25g RMS (15 degrees 2KHz) endurance, 1 hour per axis  
30,000 ft. (Epoxy Sealed Controlled environment)

**Compliance Certifications** (see [product page](#) for current document)

### Plotted and Other Data

Notes:

2 Way Power Divider SMA Interface from 350 MHz to 6 GHz Rated at 30 Watts from Fairview Microwave is in-stock and available to ship same-day. All of our RF/microwave products are available off-the-shelf from our ISO 9001:2008 certified facilities in Lewisville, Texas. Fairview Microwave is RF on-demand.

For additional information on this product, please click the following link: [2 Way Power Divider SMA Interface from 350 MHz to 6 GHz Rated at 30 Watts FMDV1053](#)

URL: <https://www.fairviewmicrowave.com/2-way-power-divider-sma-6-ghz-fmdv1053-p.aspx>

The information contained in this document is accurate to the best of our knowledge and representative of the part described herein. It may be necessary to make modifications to the part and/or the documentation of the part, in order to implement improvements. Fairview Microwave reserves the right to make such changes as required. Unless otherwise stated, all specifications are nominal. Fairview Microwave does not make any representation or warranty regarding the suitability of the part described herein for any particular purpose, and Fairview Microwave does not assume any liability arising out of the use of any part or documentation.

REVISIONS			
REV.	DESCRIPTION	DATE	APPROVED
A	INITIAL RELEASE	5/1/2020	S.PONG

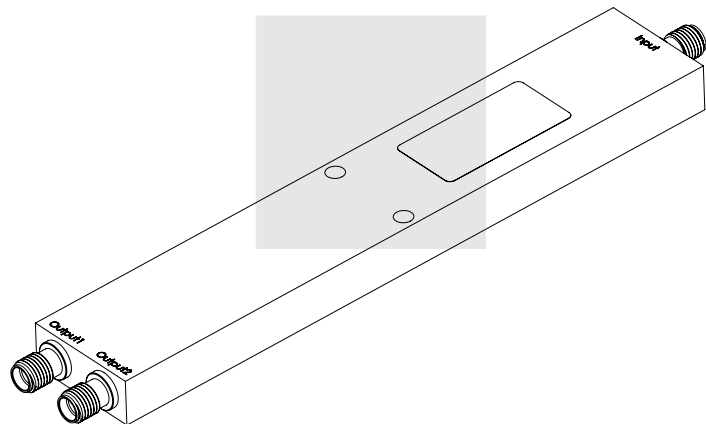
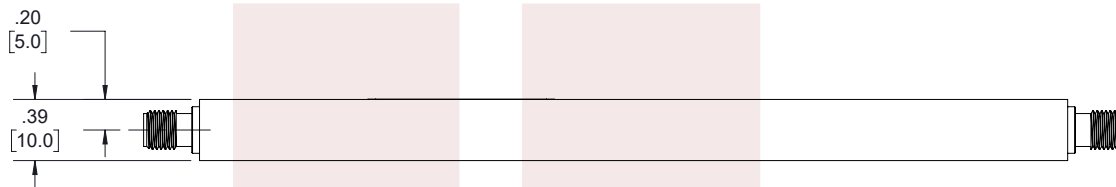
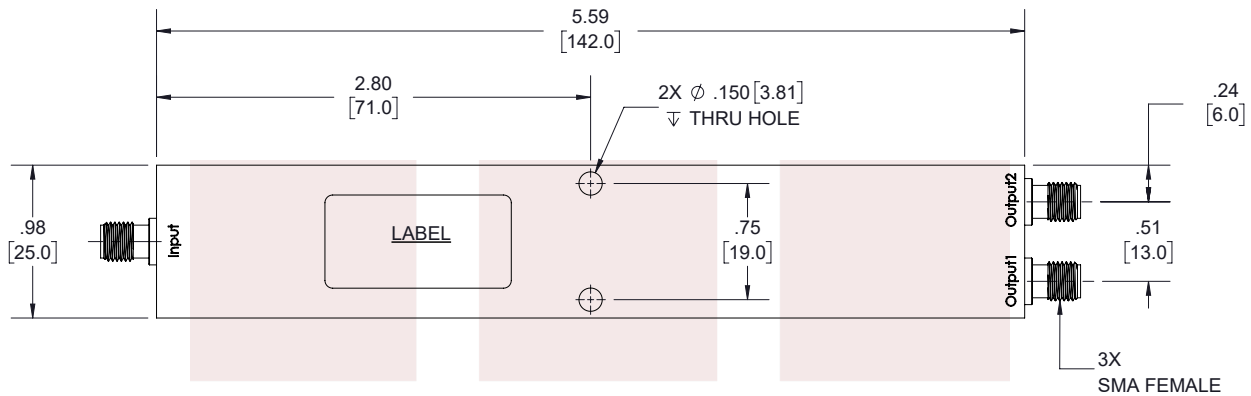

LABEL:

FAIRVIEW MICROWAVE  
FMDV1053  
D/C: YYWW

THESE COMMODITIES, TECHNOLOGY OR SOFTWARE WERE EXPORTED FROM THE UNITED STATES IN ACCORDANCE WITH THE EXPORT ADMINISTRATION REGULATIONS. DIVERSION CONTRARY TO U.S. LAW PROHIBITED.

TITLE  
2 Way Power Divider SMA Interface from 350 MHz to 6 GHz Rated at 30 Watts

UNLESS OTHERWISE SPECIFIED LEADING DIMENSIONS ARE INCHES  
DIMENSIONS IN [ ] ARE MILLIMETERS

TOLERANCES: CABLE LENGTH (L) TOLERANCES:

.X ± .2 [5.08]	FRACTIONS	L ≤ 12 [305] = +1 [25] / -0
.XX ± .02 [.51]	± 1/32	12 [305] < L ≤ 60 [1524] = +2 [51] / -0
.XXX ± .005 [.13]	ANGLES ± 1°	60 [1524] < L ≤ 120 [3048] = +4 [102] / -0
		120 [3048] < L ≤ 300 [7620] = +6 [152] / -0
		300 [7620] < L = +5%L / -0

THIRD-ANGLE PROJECTION



THE INFORMATION AND DESIGN IN THIS DOCUMENT IS THE PROPERTY OF FAIRVIEW MICROWAVE CORPORATION. ALL RIGHTS RESERVED.

SHEET 1 OF 1

SCALE N/A

ALL DIMENSIONS SHOWN ARE FOR REFERENCE ONLY.

SIZE A	CAGE CODE 3FKR5	DRAWN BY K.Dang	ITEM NO. FMDV1053	REV A
-----------	--------------------	--------------------	----------------------	----------

T-Rev.D