

Miniature circuit breakers

Circuit protection guide

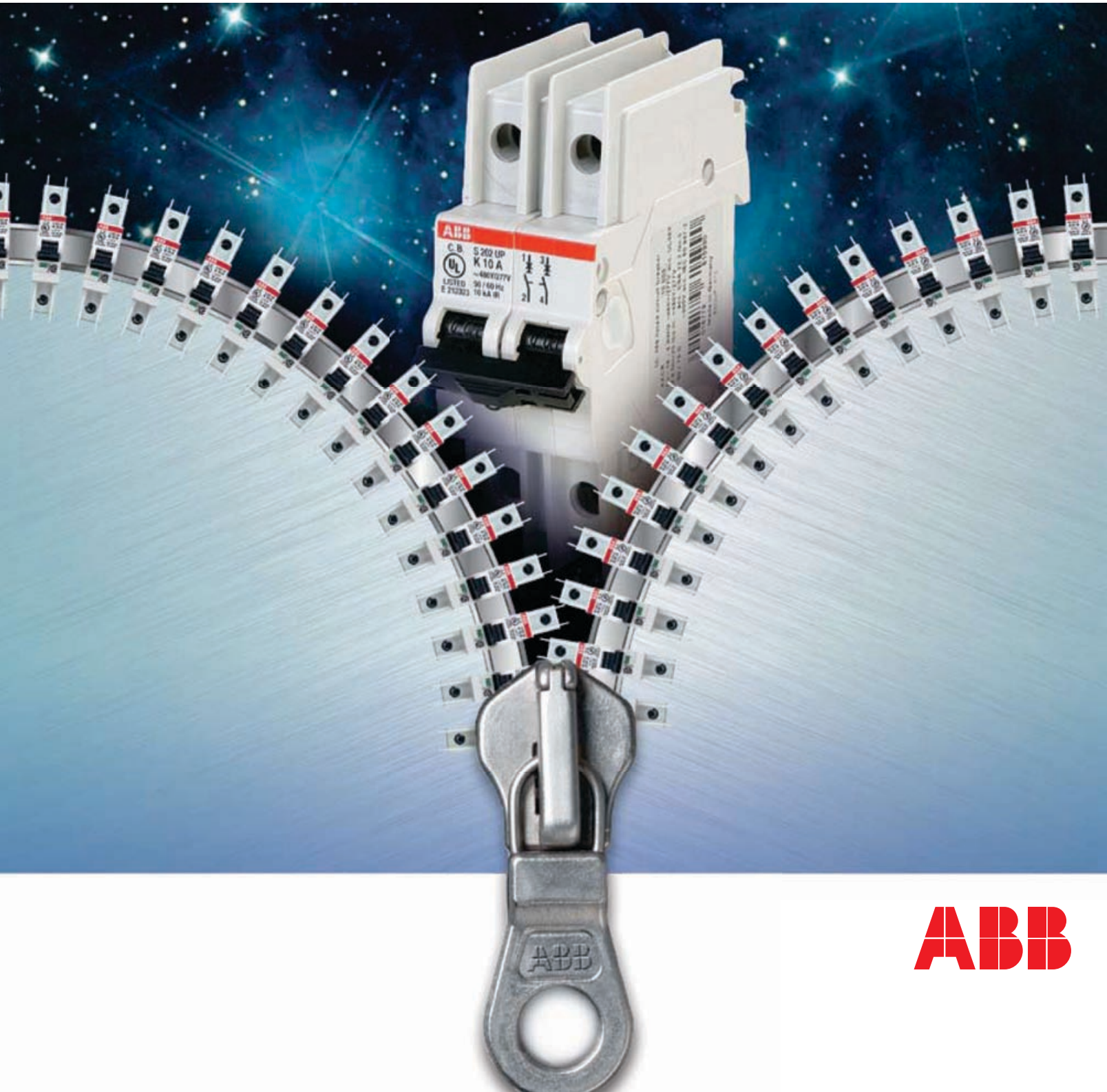

ABB



Miniature circuit breakers



S200 UL489 Miniature circuit breakers1 - 42

UL489 Series

Selection

Description.....	1
Features.....	1
S200U-K, 240 VAC.....	2
S200UP-K, 480Y/277 VAC.....	4
S200UP-Z, 480Y/277 VAC.....	5
S200U-Z, 240 VAC.....	3
S201DC, 60 VDC.....	6

Accessories

Auxiliary contacts.....	7
Bell alarm.....	7
Busbar tooth covers.....	10
Busbars, UL approved.....	10
Connection drawings.....	8
Feeder terminals.....	10
Mounting.....	9
Mounting arrangements of MCB accessories.....	7
Rotary operating mechanism.....	7
Shunt trip.....	7

Technical data

Shunt trip.....	11
Auxiliary contact S2C-H6RL & S2C-S6RU.....	11
Internal resistance & power loss.....	12
S200U, S200UP, S201DC.....	11
Temperature derating.....	13
Tripping characteristics.....	13

Dimensions

Approximate dimensions.....	8
-----------------------------	---

UL1077 Series

Selection

Description.....	15
Features.....	15
S200-B, 480Y/277 VAC.....	16
S200-C, 480Y/277 VAC.....	17
S200-D, 480Y/277 VAC.....	18
S200-K, 480Y/277 VAC.....	19
S200P-K, 480Y/277 VAC.....	20
S200P-Z, 480Y/277 VAC.....	21
S280UC-K, 500 VDC.....	23
S280UC-Z, 500 VDC.....	24
S280W-K, 480Y/277 VAC.....	22
S290, 480Y/277 VAC.....	25

Accessories

1-4 Phase w/1 auxiliary, S200, S200P, S280UC, S280W.....	30
1-4 Phase, S200, S200P, S280UC, S280W.....	29
Auxiliary contacts, S200, S200P, S280UC, S280W.....	26
Auxiliary contacts, S290.....	27
Bell alarm, S200, S200P, S280UC, S280W.....	26
Bell alarm, S290.....	27
Busbar mounted terminal block, S200, S200P, S280W, S280UC.....	31
Busbar tooth covers, S200, S200P, S280UC, S280W.....	31
Connection terminals, S200, S200P, S280UC, S280W.....	31
Mounting arrangements of MCB accessories.....	26
Shunt trip, S200, S200P, S280UC, S280W.....	26
Shunt trip, S290.....	27
Undervoltage release, S200, S200P, S280UC, S280W.....	26

Technical data

Auxiliary contact S2C-H6RU for S200U & S200UP.....	32
Internal resistance & power loss, S200 & S200P.....	33
S200 & S200P.....	33
S200, S200P, S280UC, S280W, S290.....	32
Shunt trip, S200 & S200P.....	32

Signal contact S2C-S6RU for S200U & S200UP.....	32
Temperature derating, S200 & S200P.....	33
Tripping characteristics, S200, S200P, S280UC, S280W & S290.....	34
Undervoltage release, S200 & S200P.....	32

Dimensions

S200, S200P, S280UC, S280W, S290.....	28
---------------------------------------	----

Application guide

Circuit breaker construction.....	36, 37
Circuit breaker current limitation.....	38, 39
General information.....	35
Miniature circuit breaker cutaway.....	42
Selective coordination and series ratings.....	40, 41

S800U Miniature circuit breakers.....43 - 66

UL489 Series

Selection

Description.....	43
Features.....	43
S800U-K, 240 VAC.....	44
S800U-Z, 240 VAC.....	45

IEC Series

Selection

Description.....	47
Features.....	47
S800S-B, 690 VAC.....	48
S800S-C, 690 VAC.....	49
S800S-D, 690 VAC.....	50
S800S-K, 690 VAC.....	51

UL & IEC Series

Accessories

Auxiliary contacts, S800 & S800S.....	52
Bell alarm, S800 & S800S.....	52
Rotary operating mechanisms, S800U & S800S.....	53
Shunt trip, S800 & S800S.....	52
Undervoltage release, S800 & S800S.....	52

Technical data

Accessories, S800U & S800S.....	57, 58
Auxiliary contact, S800-AUX.....	57
Backup, S800S-S200 @ 230/400 V.....	59
Combined auxiliary and bell alarm.....	58
Internal resistance and power loss, S800S.....	55
Selectivity, S800S - S200 @ 230/400 V.....	60, 61, 62, 63
Selectivity, S800S - S200P @ 230/400 V.....	64
Selectivity, S800S - S280 @ 230/400 V.....	65
Shunt operation release, S800-SOR.....	58
Temperature derating, S800S.....	55
Tripping characteristics, S800S.....	54
Undervoltage release, S800-UVR.....	57

Dimensions

S800U & S800S.....	56
--------------------	----

S500 Miniature circuit breakers67 - 74

Selection

Description.....	67
Features, UL 1077.....	67
S500-K, UL 600Y/277 VAC / IEC 690 VDC.....	68
S500-UC-B, UL 600 VDC / IEC 750 VDC.....	69
S500UC-K, UL 600 VDC / IEC 750 VDC.....	70

Continued next page

Accessories		
Auxiliary contacts.....	71	
Busbars.....	71	
Handle mechanism.....	71	
Power feed terminal.....	71	
Bell alarm.....	71	
Technical data		
S500-B & S500-K.....	72	
Dimensions		
S500 & accessories.....	73	
Technical data.....75 - 82		
Index.....	75	
S200DC-K, S201DC-Z, S200-B, S200-C,D.....	77	
S200-K, S200P-K, S200P-Z, S280W-K.....	78	
S200U-K, S200U-Z, S200UP-K, S200UP-Z.....	76	
S280UC-K, S280UC-Z, S280U-Z, S290-C.....	79	
S800U-K, Z; S800S-B, S800S-C, S800S-D.....	80	
S500UC-B, K; S500-K, Z.....	82	
S800S-K.....	81	
Residual current devices83 - 90		
Selection		
Description.....	83	
F200A, A Type.....	85	
F200AC, AC Type.....	84	
Features.....	83	
Technical data		
F200.....	86	
Performance in altitude of RCDs.....	86	
Power loss of RCDs.....	86	
F200AC & F200A.....	86, 90	
Application guide		
Difference between RCD & MCB.....	89	
Difference between Type A and AC.....	87	
Introduction.....	87	
Mechanical operations.....	88	
RCD Definitions.....	87	
RCD Mechanical operations.....	87	

PS 1/12/16BP – S202U-K0.3

Alphanumeric

Catalog No.	Page No.	Catalog No.	Page No.	Catalog No.	Page No.	Catalog No.	Page No.	Catalog No.	Page No.
PS 1/12/16BP	10	S201-D0.5	18	S201-K3	19	S201UP-K0.2	4	S202-C6	17
PS 1/18/16BP	10	S201-D0.5NA	18	S201-K32	19	S201UP-K0.3	4	S202-C63	17
PS 1/6/16BP	10	S201-D1	18	S201-K32NA	19	S201UP-K0.5	4	S202-C8	17
PS 2/12/16BP	10	S201-D1.6	18	S201-K3NA	19	S201UP-K0.75	4	S202-D0.5	18
PS 2/18/16BP	10	S201-D1.6NA	18	S201-K4	19	S201UP-K1	4	S202-D1	18
PS 2/6/16BP	10	S201-D10	18	S201-K40	19	S201UP-K1.6	4	S202-D1.6	18
PS 3/12/16BP	10	S201-D10NA	18	S201-K40NA	19	S201UP-K10	4	S202-D10	18
PS 3/18/16BP	10	S201-D13	18	S201-K4NA	19	S201UP-K15	4	S202-D13	18
PS 3/6/16BP	10	S201-D13NA	18	S201-K50	19	S201UP-K16	4	S202-D16	18
PS1/38/16H	30	S201-D16	18	S201-K50NA	19	S201UP-K2	4	S202-D2	18
PS1/38H	30	S201-D16NA	18	S201-K6	19	S201UP-K20	4	S202-D20	18
PS1/60	29	S201-D1NA	18	S201-K63	19	S201UP-K25	4	S202-D25	18
PS1/60/16	29	S201-D2	18	S201-K63NA	19	S201UP-K3	4	S202-D3	18
PS2/39/16SP	30	S201-D20	18	S201-K6NA	19	S201UP-K4	4	S202-D32	18
PS2/48/16SP	30	S201-D20NA	18	S201-K8	19	S201UP-K5	4	S202-D4	18
PS2/58/16SP	29	S201-D25	18	S201-K8NA	19	S201UP-K6	4	S202-D40	18
PS2/58SP	29	S201-D25NA	18	S201P-K0.2	20	S201UP-K8	4	S202-D50	18
PS3/60/16SP	29	S201-D2NA	18	S201P-K0.3	20	S201UP-Z0.5	5	S202-D6	18
PS3/60SP	29	S201-D3	18	S201P-K0.5	20	S201UP-Z1	5	S202-D63	18
PS4/58/16NSP	30	S201-D32	18	S201P-K0.75	20	S201UP-Z1.6	5	S202-D8	18
PS4/60/16SP	29	S201-D32NA	18	S201P-K1	20	S201UP-Z10	5	S202-K0.5	19
S201-B10	16	S201-D3NA	18	S201P-K1.6	20	S201UP-Z15	5	S202-K1	19
S201-B10NA	16	S201-D4	18	S201P-K10	20	S201UP-Z16	5	S202-K1.6	19
S201-B13	16	S201-D40	18	S201P-K13	20	S201UP-Z2	5	S202-K10	19
S201-B13NA	16	S201-D40NA	18	S201P-K16	20	S201UP-Z20	5	S202-K13	19
S201-B16	16	S201-D4NA	18	S201P-K2	20	S201UP-Z25	5	S202-K16	19
S201-B16NA	16	S201-D50	18	S201P-K20	20	S201UP-Z3	5	S202-K2	19
S201-B20	16	S201-D50NA	18	S201P-K25	20	S201UP-Z4	5	S202-K20	19
S201-B20NA	16	S201-D6	18	S201P-K3	20	S201UP-Z5	5	S202-K25	19
S201-B25	16	S201-D63	18	S201P-K32	20	S201UP-Z6	5	S202-K3	19
S201-B25NA	16	S201-D63NA	18	S201P-K4	20	S201UP-Z8	5	S202-K32	19
S201-B32	16	S201-D6NA	18	S201P-K40	20	S201U-Z0.5	3	S202-K4	19
S201-B32NA	16	S201-D8	18	S201P-K50	20	S201U-Z1	3	S202-K40	19
S201-B40	16	S201-D8NA	18	S201P-K6	20	S201U-Z1.6	3	S202-K50	19
S201-B40NA	16	S201DC-K1	6	S201P-K63	20	S201U-Z10	3	S202-K6	19
S201-B50	16	S201DC-K1.6	6	S201P-K8	20	S201U-Z15	3	S202-K63	19
S201-B50NA	16	S201DC-K10	6	S201P-Z0.5	21	S201U-Z16	3	S202-K8	19
S201-B6	16	S201DC-K13	6	S201P-Z1	21	S201U-Z2	3	S202P-K0.2	20
S201-B63	16	S201DC-K16	6	S201P-Z1.6	21	S201U-Z20	3	S202P-K0.3	20
S201-B63NA	16	S201DC-K2	6	S201P-Z10	21	S201U-Z25	3	S202P-K0.5	20
S201-B6NA	16	S201DC-K20	6	S201P-Z16	21	S201U-Z3	3	S202P-K0.75	20
S201-C0.5	17	S201DC-K25	6	S201P-Z2	21	S201U-Z30	3	S202P-K1	20
S201-C0.5NA	17	S201DC-K3	6	S201P-Z20	21	S201U-Z32	3	S202P-K1.6	20
S201-C1	17	S201DC-K4	6	S201P-Z25	21	S201U-Z4	3	S202P-K10	20
S201-C1.6	17	S201DC-K6	6	S201P-Z3	21	S201U-Z40	3	S202P-K13	20
S201-C1.6NA	17	S201DC-K8	6	S201P-Z32	21	S201U-Z5	3	S202P-K16	20
S201-C10	17	S201DC-Z1	6	S201P-Z4	21	S201U-Z50	3	S202P-K2	20
S201-C10NA	17	S201DC-Z1.6	6	S201P-Z40	21	S201U-Z6	3	S202P-K20	20
S201-C13	17	S201DC-Z10	6	S201P-Z50	21	S201U-Z60	3	S202P-K25	20
S201-C13NA	17	S201DC-Z16	6	S201P-Z6	21	S201U-Z63	3	S202P-K3	20
S201-C16	17	S201DC-Z2	6	S201P-Z63	21	S201U-Z8	3	S202P-K32	20
S201-C16NA	17	S201DC-Z20	6	S201P-Z8	21	S202-B10	16	S202P-K4	20
S201-C1NA	17	S201DC-Z25	6	S201U-K0.2	2	S202-B13	16	S202P-K40	20
S201-C2	17	S201DC-Z3	6	S201U-K0.3	2	S202-B16	16	S202P-K50	20
S201-C20	17	S201DC-Z4	6	S201U-K0.5	2	S202-B20	16	S202P-K6	20
S201-C20NA	17	S201DC-Z6	6	S201U-K0.75	2	S202-B25	16	S202P-K63	20
S201-C25	17	S201DC-Z8	6	S201U-K1	2	S202-B32	16	S202P-K8	20
S201-C25NA	17	S201-K0.5	19	S201U-K1.6	2	S202-B40	16	S202P-Z0.5	21
S201-C2NA	17	S201-K0.5NA	19	S201U-K10	2	S202-B50	16	S202P-Z1	21
S201-C3	17	S201-K1	19	S201U-K15	2	S202-B6	16	S202P-Z1.6	21
S201-C32	17	S201-K1.6	19	S201U-K16	2	S202-B63	16	S202P-Z10	21
S201-C32NA	17	S201-K1.6NA	19	S201U-K2	2	S202-C0.5	17	S202P-Z16	21
S201-C3NA	17	S201-K10	19	S201U-K20	2	S202-C1	17	S202P-Z2	21
S201-C4	17	S201-K10NA	19	S201U-K25	2	S202-C1.6	17	S202P-Z20	21
S201-C40	17	S201-K13	19	S201U-K3	2	S202-C10	17	S202P-Z25	21
S201-C40NA	17	S201-K13NA	19	S201U-K30	2	S202-C13	17	S202P-Z3	21
S201-C4NA	17	S201-K16	19	S201U-K32	2	S202-C16	17	S202P-Z32	21
S201-C50	17	S201-K16NA	19	S201U-K4	2	S202-C2	17	S202P-Z4	21
S201-C50NA	17	S201-K1NA	19	S201U-K40	2	S202-C20	17	S202P-Z40	21
S201-C6	17	S201-K2	19	S201U-K5	2	S202-C25	17	S202P-Z50	21
S201-C63	17	S201-K20	19	S201U-K50	2	S202-C3	17	S202P-Z6	21
S201-C63NA	17	S201-K20NA	19	S201U-K6	2	S202-C32	17	S202P-Z63	21
S201-C6NA	17	S201-K25	19	S201U-K60	2	S202-C4	17	S202P-Z8	21
S201-C8	17	S201-K25NA	19	S201U-K63	2	S202-C40	17	S202U-K0.2	2
S201-C8NA	17	S201-K2NA	19	S201U-K8	2	S202-C50	17	S202U-K0.3	2

Catalog No.	Page No.	Catalog No.	Page No.	Catalog No.	Page No.	Catalog No.	Page No.	Catalog No.	Page No.
S202U-K0.5	2	S203-B13NA	16	S203-D40NA	18	S203P-Z40	21	S203U-Z6	3
S202U-K0.75	2	S203-B16	16	S203-D4NA	18	S203P-Z50	21	S203U-Z60	3
S202U-K1	2	S203-B16NA	16	S203-D50	18	S203P-Z6	21	S203U-Z63	3
S202U-K1.6	2	S203-B20	16	S203-D50NA	18	S203P-Z63	21	S203U-Z8	3
S202U-K10	2	S203-B20NA	16	S203-D6	18	S203P-Z8	21	S204-B10	16
S202U-K15	2	S203-B25	16	S203-D63	18	S203U-K0.2	2	S204-B13	16
S202U-K16	2	S203-B25NA	16	S203-D63NA	18	S203U-K0.3	2	S204-B16	16
S202U-K2	2	S203-B32	16	S203-D6NA	18	S203U-K0.5	2	S204-B20	16
S202U-K20	2	S203-B32NA	16	S203-D8	18	S203U-K0.75	2	S204-B25	16
S202U-K25	2	S203-B40	16	S203-D8NA	18	S203U-K1	2	S204-B32	16
S202U-K3	2	S203-B40NA	16	S203-K0.5	19	S203U-K1.6	2	S204-B40	16
S202U-K30	2	S203-B50	16	S203-K0.5NA	19	S203U-K10	2	S204-B50	16
S202U-K32	2	S203-B50NA	16	S203-K1	19	S203U-K15	2	S204-B6	16
S202U-K4	2	S203-B6	16	S203-K1.6	19	S203U-K16	2	S204-B63	16
S202U-K40	2	S203-B63	16	S203-K1.6NA	19	S203U-K2	2	S204-C0.5	17
S202U-K5	2	S203-B63NA	16	S203-K10	19	S203U-K20	2	S204-C1	17
S202U-K50	2	S203-B6NA	16	S203-K10NA	19	S203U-K25	2	S204-C1.6	17
S202U-K6	2	S203-C0.5	17	S203-K13	19	S203U-K3	2	S204-C10	17
S202U-K60	2	S203-C0.5NA	17	S203-K13NA	19	S203U-K30	2	S204-C13	17
S202U-K63	2	S203-C1	17	S203-K16	19	S203U-K32	2	S204-C16	17
S202U-K8	2	S203-C1.6	17	S203-K16NA	19	S203U-K4	2	S204-C2	17
S202UP-K0.2	4	S203-C1.6NA	17	S203-K1NA	19	S203U-K40	2	S204-C20	17
S202UP-K0.3	4	S203-C10	17	S203-K2	19	S203U-K5	2	S204-C25	17
S202UP-K0.5	4	S203-C10NA	17	S203-K20	19	S203U-K50	2	S204-C3	17
S202UP-K0.75	4	S203-C13	17	S203-K20NA	19	S203U-K6	2	S204-C32	17
S202UP-K1	4	S203-C13NA	17	S203-K25	19	S203U-K60	2	S204-C4	17
S202UP-K1.6	4	S203-C16	17	S203-K25NA	19	S203U-K63	2	S204-C40	17
S202UP-K10	4	S203-C16NA	17	S203-K2NA	19	S203U-K8	2	S204-C50	17
S202UP-K15	4	S203-C1NA	17	S203-K3	19	S203UP-K0.2	4	S204-C6	17
S202UP-K16	4	S203-C2	17	S203-K32	19	S203UP-K0.3	4	S204-C63	17
S202UP-K2	4	S203-C20	17	S203-K32NA	19	S203UP-K0.5	4	S204-C8	17
S202UP-K20	4	S203-C20NA	17	S203-K3NA	19	S203UP-K0.75	4	S204-D0.5	18
S202UP-K25	4	S203-C25	17	S203-K4	19	S203UP-K1	4	S204-D1	18
S202UP-K3	4	S203-C25NA	17	S203-K40	19	S203UP-K1.6	4	S204-D1.6	18
S202UP-K4	4	S203-C2NA	17	S203-K40NA	19	S203UP-K10	4	S204-D10	18
S202UP-K5	4	S203-C3	17	S203-K4NA	19	S203UP-K15	4	S204-D13	18
S202UP-K6	4	S203-C32	17	S203-K50	19	S203UP-K16	4	S204-D16	18
S202UP-K8	4	S203-C32NA	17	S203-K50NA	19	S203UP-K2	4	S204-D2	18
S202UP-Z0.5	5	S203-C3NA	17	S203-K6	19	S203UP-K20	4	S204-D20	18
S202UP-Z1	5	S203-C4	17	S203-K63	19	S203UP-K25	4	S204-D25	18
S202UP-Z1.6	5	S203-C40	17	S203-K63NA	19	S203UP-K3	4	S204-D3	18
S202UP-Z10	5	S203-C40NA	17	S203-K6NA	19	S203UP-K4	4	S204-D32	18
S202UP-Z15	5	S203-C4NA	17	S203-K8	19	S203UP-K5	4	S204-D4	18
S202UP-Z16	5	S203-C50	17	S203-K8NA	19	S203UP-K6	4	S204-D40	18
S202UP-Z2	5	S203-C50NA	17	S203P-K0.2	20	S203UP-K8	4	S204-D50	18
S202UP-Z20	5	S203-C6	17	S203P-K0.3	20	S203UP-Z0.5	5	S204-D6	18
S202UP-Z25	5	S203-C63	17	S203P-K0.5	20	S203UP-Z1	5	S204-D63	18
S202UP-Z3	5	S203-C63NA	17	S203P-K0.75	20	S203UP-Z1.6	5	S204-D8	18
S202UP-Z4	5	S203-C6NA	17	S203P-K1	20	S203UP-Z10	5	S204-K0.5	19
S202UP-Z5	5	S203-C8	17	S203P-K1.6	20	S203UP-Z15	5	S204-K1	19
S202UP-Z6	5	S203-C8NA	17	S203P-K10	20	S203UP-Z16	5	S204-K1.6	19
S202UP-Z8	5	S203-D0.5	18	S203P-K13	20	S203UP-Z2	5	S204-K10	19
S202U-Z0.5	3	S203-D0.5NA	18	S203P-K16	20	S203UP-Z20	5	S204-K13	19
S202U-Z1	3	S203-D1	18	S203P-K2	20	S203UP-Z25	5	S204-K16	19
S202U-Z1.6	3	S203-D1.6	18	S203P-K20	20	S203UP-Z3	5	S204-K2	19
S202U-Z10	3	S203-D1.6NA	18	S203P-K25	20	S203UP-Z4	5	S204-K20	19
S202U-Z15	3	S203-D10	18	S203P-K3	20	S203UP-Z5	5	S204-K25	19
S202U-Z16	3	S203-D10NA	18	S203P-K32	20	S203UP-Z6	5	S204-K3	19
S202U-Z2	3	S203-D13	18	S203P-K4	20	S203UP-Z8	5	S204-K32	19
S202U-Z20	3	S203-D13NA	18	S203P-K40	20	S203U-Z0.5	3	S204-K4	19
S202U-Z25	3	S203-D16	18	S203P-K50	20	S203U-Z1	3	S204-K40	19
S202U-Z3	3	S203-D16NA	18	S203P-K6	20	S203U-Z1.6	3	S204-K50	19
S202U-Z30	3	S203-D1NA	18	S203P-K63	20	S203U-Z10	3	S204-K6	19
S202U-Z32	3	S203-D2	18	S203P-K8	20	S203U-Z15	3	S204-K63	19
S202U-Z4	3	S203-D20	18	S203P-Z0.5	21	S203U-Z16	3	S204-K8	19
S202U-Z40	3	S203-D20NA	18	S203P-Z1	21	S203U-Z2	3	S204U-K0.2	2
S202U-Z5	3	S203-D25	18	S203P-Z1.6	21	S203U-Z20	3	S204U-K0.3	2
S202U-Z50	3	S203-D25NA	18	S203P-Z10	21	S203U-Z25	3	S204U-K0.5	2
S202U-Z6	3	S203-D2NA	18	S203P-Z16	21	S203U-Z3	3	S204U-K0.75	2
S202U-Z60	3	S203-D3	18	S203P-Z2	21	S203U-Z30	3	S204U-K1	2
S202U-Z63	3	S203-D32	18	S203P-Z20	21	S203U-Z32	3	S204U-K1.6	2
S202U-Z8	3	S203-D32NA	18	S203P-Z25	21	S203U-Z4	3	S204U-K10	2
S203-B10	16	S203-D3NA	18	S203P-Z3	21	S203U-Z40	3	S204U-K15	2
S203-B10NA	16	S203-D4	18	S203P-Z32	21	S203U-Z5	3	S204U-K16	2
S203-B13	16	S203-D40	18	S203P-Z4	21	S203U-Z50	3	S204U-K2	2

S204U-K20 – S502UC-K45

Alphanumeric

Catalog No.	Page No.	Catalog No.	Page No.	Catalog No.	Page No.	Catalog No.	Page No.	Catalog No.	Page No.
S204U-K20	2	S281-K2W	22	S282UC-K3	23	S283UC-Z50	24	S501UC-B40	15.69
S204U-K25	2	S281-K32W	22	S282UC-K32	23	S283UC-Z6	24	S501UC-B50	15.69
S204U-K3	2	S281-K3W	22	S282UC-K4	23	S283UC-Z63	24	S501UC-B6	15.69
S204U-K30	2	S281-K40W	22	S282UC-K40	23	S283UC-Z8	24	S501UC-B63	15.69
S204U-K32	2	S281-K4W	22	S282UC-K50	23	S290-A1	27	S501UC-K0.15	15.70
S204U-K4	2	S281-K50W	22	S282UC-K6	23	S290-A2	27	S501UC-K0.21	15.70
S204U-K40	2	S281-K63W	22	S282UC-K63	23	S290-H11	27	S501UC-K0.3	15.70
S204U-K5	2	S281-K6W	22	S282UC-K8	23	S290-S	27	S501UC-K0.42	15.70
S204U-K50	2	S281-K8W	22	S282UC-Z0.5	24	S291-C100	25	S501UC-K0.58	15.70
S204U-K6	2	S281UC-K0,2	23	S282UC-Z1	24	S291-C125	25	S501UC-K0.8	15.70
S204U-K60	2	S281UC-K0,3	23	S282UC-Z1.6	24	S291-C80	25	S501UC-K1.1	15.70
S204U-K63	2	S281UC-K0,5	23	S282UC-Z10	24	S292-C100	25	S501UC-K1.5	15.70
S204U-K8	2	S281UC-K0,75	23	S282UC-Z16	24	S292-C125	25	S501UC-K11	15.70
S204UP-K0.2	4	S281UC-K1	23	S282UC-Z2	24	S292-C80	25	S501UC-K15	15.70
S204UP-K0.3	4	S281UC-K1,6	23	S282UC-Z20	24	S293-C100	25	S501UC-K2.1	15.70
S204UP-K0.5	4	S281UC-K10	23	S282UC-Z25	24	S293-C125	25	S501UC-K20	15.70
S204UP-K0.75	4	S281UC-K16	23	S282UC-Z3	24	S293-C80	25	S501UC-K26	15.70
S204UP-K1	4	S281UC-K2	23	S282UC-Z32	24	S294-C100	25	S501UC-K3	15.70
S204UP-K1.6	4	S281UC-K20	23	S282UC-Z4	24	S294-C125	25	S501UC-K32	15.70
S204UP-K10	4	S281UC-K25	23	S282UC-Z40	24	S294-C80	25	S501UC-K37	15.70
S204UP-K15	4	S281UC-K3	23	S282UC-Z50	24	S2C-A1	26	S501UC-K4.2	15.70
S204UP-K16	4	S281UC-K32	23	S282UC-Z6	24	S2C-A1U	7	S501UC-K41	15.70
S204UP-K2	4	S281UC-K4	23	S282UC-Z63	24	S2C-A2	26	S501UC-K45	15.70
S204UP-K20	4	S281UC-K40	23	S282UC-Z8	24	S2C-A2U	7	S501UC-K5.8	15.70
S204UP-K25	4	S281UC-K50	23	S283-K0.2W	22	S2C-DH	7	S501UC-K8	15.70
S204UP-K3	4	S281UC-K6	23	S283-K0.3W	22	S2C-H6R	26	S502-K0.15	15.68
S204UP-K4	4	S281UC-K63	23	S283-K0.5W	22	S2C-H6RU	7	S502-K0.21	15.68
S204UP-K5	4	S281UC-K8	23	S283-K0.75W	22	S2C-S/H6R	26	S502-K0.3	15.68
S204UP-K6	4	S281UC-Z0.5	24	S283-K1,6W	22	S2C-S6RU	7	S502-K0.42	15.68
S204UP-K8	4	S281UC-Z1	24	S283-K10W	22	S2C-UA 110	26	S502-K0.58	15.68
S204UP-Z0.5	5	S281UC-Z1.6	24	S283-K13W	22	S2C-UA 12	26	S502-K0.8	15.68
S204UP-Z1	5	S281UC-Z10	24	S283-K16W	22	S2C-UA 230	26	S502-K1.1	15.68
S204UP-Z1.6	5	S281UC-Z16	24	S283-K1W	22	S2C-UA 24	26	S502-K1.5	15.68
S204UP-Z10	5	S281UC-Z2	24	S283-K20W	22	S2C-UA 400	26	S502-K11	15.68
S204UP-Z15	5	S281UC-Z20	24	S283-K25W	22	S2C-UA 48	26	S502-K15	15.68
S204UP-Z16	5	S281UC-Z25	24	S283-K2W	22	S500-BB23	15.71	S502-K2.1	15.68
S204UP-Z2	5	S281UC-Z3	24	S283-K32W	22	S500-BB33	15.71	S502-K20	15.68
S204UP-Z20	5	S281UC-Z32	24	S283-K3W	22	S500-BB43	15.71	S502-K26	15.68
S204UP-Z25	5	S281UC-Z4	24	S283-K40W	22	S500-BB53	15.71	S502-K3	15.68
S204UP-Z3	5	S281UC-Z40	24	S283-K4W	22	S500-BB63	15.71	S502-K32	15.68
S204UP-Z4	5	S281UC-Z50	24	S283-K50W	22	S500-H02	15.71	S502-K37	15.68
S204UP-Z5	5	S281UC-Z6	24	S283-K63W	22	S500-H11	15.71	S502-K4.2	15.68
S204UP-Z6	5	S281UC-Z63	24	S283-K6W	22	S500-H20	15.71	S502-K41	15.68
S204UP-Z8	5	S281UC-Z8	24	S283-K8W	22	S500-K2	15.71	S502-K45	15.68
S204U-Z0.5	3	S282-K0.2W	22	S283UC-K0.2	23	S500-RD3	15.71	S502-K5.8	15.68
S204U-Z1	3	S282-K0.3W	22	S283UC-K0.3	23	S500-S02	15.71	S502-K8	15.68
S204U-Z1.6	3	S282-K0.5W	22	S283UC-K0.5	23	S500-S11	15.71	S502UC-B10	15.69
S204U-Z10	3	S282-K0.75W	22	S283UC-K0.75	23	S500-S20	15.71	S502UC-B13	15.69
S204U-Z15	3	S282-K1,6W	22	S283UC-K1	23	S501-K0.15	15.68	S502UC-B16	15.69
S204U-Z16	3	S282-K10W	22	S283UC-K1.6	23	S501-K0.21	15.68	S502UC-B20	15.69
S204U-Z2	3	S282-K13W	22	S283UC-K10	23	S501-K0.3	15.68	S502UC-B25	15.69
S204U-Z20	3	S282-K16W	22	S283UC-K16	23	S501-K0.42	15.68	S502UC-B32	15.69
S204U-Z25	3	S282-K1W	22	S283UC-K2	23	S501-K0.58	15.68	S502UC-B40	15.69
S204U-Z3	3	S282-K20W	22	S283UC-K20	23	S501-K0.8	15.68	S502UC-B50	15.69
S204U-Z30	3	S282-K25W	22	S283UC-K25	23	S501-K1.1	15.68	S502UC-B6	15.69
S204U-Z32	3	S282-K2W	22	S283UC-K3	23	S501-K1.5	15.68	S502UC-B63	15.69
S204U-Z4	3	S282-K32W	22	S283UC-K32	23	S501-K11	15.68	S502UC-K0.15	15.70
S204U-Z40	3	S282-K3W	22	S283UC-K4	23	S501-K15	15.68	S502UC-K0.21	15.70
S204U-Z5	3	S282-K40W	22	S283UC-K40	23	S501-K2.1	15.68	S502UC-K0.3	15.70
S204U-Z50	3	S282-K4W	22	S283UC-K50	23	S501-K20	15.68	S502UC-K0.42	15.70
S204U-Z6	3	S282-K50W	22	S283UC-K6	23	S501-K26	15.68	S502UC-K0.58	15.70
S204U-Z60	3	S282-K63W	22	S283UC-K63	23	S501-K3	15.68	S502UC-K0.8	15.70
S204U-Z63	3	S282-K6W	22	S283UC-K8	23	S501-K32	15.68	S502UC-K1.1	15.70
S204U-Z8	3	S282-K8W	22	S283UC-Z0.5	24	S501-K37	15.68	S502UC-K1.5	15.70
S281-K0.2W	22	S282UC-K0,2	23	S282UC-Z1	24	S501-K4.2	15.68	S502UC-K11	15.70
S281-K0.3W	22	S282UC-K0,3	23	S282UC-Z1.6	24	S501-K41	15.68	S502UC-K15	15.70
S281-K0.5W	22	S282UC-K0,5	23	S282UC-Z10	24	S501-K45	15.68	S502UC-K2.1	15.70
S281-K0.75W	22	S282UC-K0,75	23	S282UC-Z16	24	S501-K5.8	15.68	S502UC-K20	15.70
S281-K1.6W	22	S282UC-K1	23	S282UC-Z2	24	S501-K8	15.68	S502UC-K26	15.70
S281-K10W	22	S282UC-K1,6	23	S282UC-Z20	24	S501UC-B10	15.69	S502UC-K3	15.70
S281-K13W	22	S282UC-K10	23	S282UC-Z25	24	S501UC-B13	15.69	S502UC-K32	15.70
S281-K16W	22	S282UC-K16	23	S282UC-Z3	24	S501UC-B16	15.69	S502UC-K37	15.70
S281-K1W	22	S282UC-K2	23	S282UC-Z32	24	S501UC-B20	15.69	S502UC-K4.2	15.70
S281-K20W	22	S282UC-K20	23	S282UC-Z4	24	S501UC-B25	15.69	S502UC-K41	15.70
S281-K25W	22	S282UC-K25	23	S282UC-Z40	24	S501UC-B32	15.69	S502UC-K45	15.70

Catalog No.	Page No.	Catalog No.	Page No.	Catalog No.	Page No.	Catalog No.	Page No.	Catalog No.	Page No.
S502UC-K8	15.70	S504UC-K20	15.70	S801U-K20	44	S802U-K40	44	S803U-K70	44
S503-K0.15	15.68	S504UC-K26	15.70	S801U-K25	44	S802U-K50	44	S803U-K80	44
S503-K0.21	15.68	S504UC-K3	15.70	S801U-K30	44	S802U-K60	44	S803U-K90	44
S503-K0.3	15.68	S504UC-K32	15.70	S801U-K40	44	S802U-K70	44	S803U-Z10	45
		S504UC-K37	15.70	S801U-K50	44	S802U-K80	44	S803U-Z100	45
S503-K0.42	15.68	S504UC-K4.2	15.70	S801U-K60	44	S802U-K90	44	S803U-Z15	45
S503-K0.58	15.68	S504UC-K41	15.70	S801U-K70	44	S802U-Z10	45	S803U-Z20	45
S503-K0.8	15.68	S504UC-K45	15.70	S801U-K80	44	S802U-Z100	45	S803U-Z25	45
S503-K1.1	15.68	S504UC-K5.8	15.70	S801U-K90	44	S802U-Z15	45	S803U-Z30	45
S503-K1.5	15.68	S504UC-K8	15.70	S801U-Z10	45	S802U-Z20	45	S803U-Z40	45
S503-K11	15.68	S800-AUX	52	S801U-Z100	45	S802U-Z25	45	S803U-Z50	45
S503-K15	15.68	S800-AUX/ALT	52	S801U-Z15	45	S802U-Z30	45	S803U-Z60	45
S503-K2.1	15.68	S800-RD	53	S801U-Z20	45	S802U-Z40	45	S803U-Z70	45
S503-K20	15.68	S800-RHE-EM	53	S801U-Z25	45	S802U-Z50	45	S803U-Z80	45
S503-K26	15.68	S800-RHE-H	53	S801U-Z30	45	S802U-Z60	45	S803U-Z90	45
S503-K3	15.68	S800-RHE-S	53	S801U-Z40	45	S802U-Z70	45	S804S-B10	48
S503-K32	15.68	S800-RT2125	53	S801U-Z50	45	S802U-Z80	45	S804S-B100	48
S503-K37	15.68	S800-SOR130	52	S801U-Z60	45	S802U-Z90	45	S804S-B125	48
S503-K4.2	15.68	S800-SOR24	52	S801U-Z70	45	S803S-B10	48	S804S-B13	48
S503-K41	15.68	S800-SOR250	52	S801U-Z80	45	S803S-B100	48	S804S-B16	48
S503-K45	15.68	S800-UVR130	52	S801U-Z90	45	S803S-B125	48	S804S-B20	48
S503-K5.8	15.68	S800-UVR250	52	S802S-B10	48	S803S-B13	48	S804S-B25	48
S503-K8	15.68	S800-UVR36	52	S802S-B100	48	S803S-B16	48	S804S-B32	48
S503UC-B10	15.69	S800-UVR60	52	S802S-B125	48	S803S-B20	48	S804S-B40	48
S503UC-B13	15.69	S801S-B10	48	S802S-B13	48	S803S-B25	48	S804S-B50	48
S503UC-B16	15.69	S801S-B100	48	S802S-B16	48	S803S-B32	48	S804S-B63	48
S503UC-B20	15.69	S801S-B125	48	S802S-B20	48	S803S-B40	48	S804S-B80	48
S503UC-B25	15.69	S801S-B13	48	S802S-B25	48	S803S-B50	48	S804S-C10	49
S503UC-B32	15.69	S801S-B16	48	S802S-B32	48	S803S-B63	48	S804S-C100	49
S503UC-B40	15.69	S801S-B20	48	S802S-B40	48	S803S-B80	48	S804S-C125	49
S503UC-B50	15.69	S801S-B25	48	S802S-B50	48	S803S-C10	49	S804S-C13	49
S503UC-B6	15.69	S801S-B32	48	S802S-B63	48	S803S-C100	49	S804S-C16	49
S503UC-B63	15.69	S801S-B40	48	S802S-B80	48	S803S-C125	49	S804S-C20	49
S503UC-K0.15	15.70	S801S-B50	48	S802S-C10	49	S803S-C13	49	S804S-C25	49
S503UC-K0.21	15.70	S801S-B63	48	S802S-C100	49	S803S-C16	49	S804S-C32	49
S503UC-K0.3	15.70	S801S-B80	48	S802S-C125	49	S803S-C20	49	S804S-C40	49
S503UC-K0.42	15.70	S801S-C10	49	S802S-C13	49	S803S-C25	49	S804S-C50	49
S503UC-K0.58	15.70	S801S-C100	49	S802S-C16	49	S803S-C32	49	S804S-C63	49
S503UC-K0.8	15.70	S801S-C125	49	S802S-C20	49	S803S-C40	49	S804S-C80	49
S503UC-K1.1	15.70	S801S-C13	49	S802S-C25	49	S803S-C50	49	S804S-D10	50
S503UC-K1.5	15.70	S801S-C16	49	S802S-C32	49	S803S-C63	49	S804S-D100	50
S503UC-K11	15.70	S801S-C20	49	S802S-C40	49	S803S-C80	49	S804S-D125	50
S503UC-K15	15.70	S801S-C25	49	S802S-C50	49	S803S-D10	50	S804S-D13	50
S503UC-K2.1	15.70	S801S-C32	49	S802S-C63	49	S803S-D100	50	S804S-D16	50
S503UC-K20	15.70	S801S-C40	49	S802S-C80	49	S803S-D125	50	S804S-D20	50
S503UC-K26	15.70	S801S-C50	49	S802S-D10	50	S803S-D13	50	S804S-D25	50
S503UC-K3	15.70	S801S-C63	49	S802S-D100	50	S803S-D16	50	S804S-D32	50
S503UC-K32	15.70	S801S-C80	49	S802S-D125	50	S803S-D20	50	S804S-D40	50
S503UC-K37	15.70	S801S-D10	50	S802S-D13	50	S803S-D25	50	S804S-D50	50
S503UC-K4.2	15.70	S801S-D100	50	S802S-D16	50	S803S-D32	50	S804S-D63	50
S503UC-K41	15.70	S801S-D125	50	S802S-D20	50	S803S-D40	50	S804S-D80	50
S503UC-K45	15.70	S801S-D13	50	S802S-D25	50	S803S-D50	50	S804S-K10	51
S503UC-K5.8	15.70	S801S-D16	50	S802S-D32	50	S803S-D63	50	S804S-K100	51
S503UC-K8	15.70	S801S-D20	50	S802S-D40	50	S803S-D80	50	S804S-K125	51
S504UC-B10	15.69	S801S-D25	50	S802S-D50	50	S803S-K10	51	S804S-K13	51
S504UC-B13	15.69	S801S-D32	50	S802S-D63	50	S803S-K100	51	S804S-K16	51
S504UC-B16	15.69	S801S-D40	50	S802S-D80	50	S803S-K125	51	S804S-K20	51
S504UC-B20	15.69	S801S-D50	50	S802S-K10	51	S803S-K13	51	S804S-K25	51
S504UC-B25	15.69	S801S-D63	50	S802S-K100	51	S803S-K16	51	S804S-K32	51
S504UC-B32	15.69	S801S-D80	50	S802S-K125	51	S803S-K20	51	S804S-K40	51
S504UC-B40	15.69	S801S-K10	51	S802S-K13	51	S803S-K25	51	S804S-K50	51
S504UC-B50	15.69	S801S-K100	51	S802S-K16	51	S803S-K32	51	S804S-K63	51
S504UC-B6	15.69	S801S-K125	51	S802S-K20	51	S803S-K40	51	S804S-K80	51
S504UC-B63	15.69	S801S-K13	51	S802S-K25	51	S803S-K50	51	S804U-K10	44
S504UC-K0.15	15.70	S801S-K16	51	S802S-K32	51	S803S-K63	51	S804U-K100	44
S504UC-K0.21	15.70	S801S-K20	51	S802S-K40	51	S803S-K80	51	S804U-K15	44
S504UC-K0.3	15.70	S801S-K25	51	S802S-K50	51	S803U-K10	44	S804U-K20	44
S504UC-K0.42	15.70	S801S-K32	51	S802S-K63	51	S803U-K100	44	S804U-K25	44
S504UC-K0.58	15.70	S801S-K40	51	S802S-K80	51	S803U-K15	44	S804U-K30	44
S504UC-K0.8	15.70	S801S-K50	51	S802U-K10	44	S803U-K20	44	S804U-K40	44
S504UC-K1.1	15.70	S801S-K63	51	S802U-K100	44	S803U-K25	44	S804U-K50	44
S504UC-K1.5	15.70	S801S-K80	51	S802U-K15	44	S803U-K30	44	S804U-K60	44
S504UC-K11	15.70	S801U-K10	44	S802U-K20	44	S803U-K40	44	S804U-K70	44
S504UC-K15	15.70	S801U-K100	44	S802U-K25	44	S803U-K50	44	S804U-K80	44
S504UC-K2.1	15.70	S801U-K15	44	S802U-K30	44	S803U-K60	44	S804U-K90	44

S804U-Z10 – SZ-ESK2

Alphanumeric

Catalog No.	Page No.	Catalog No.	Page No.	Catalog No.	Page No.	Catalog No.	Page No.	Catalog No.	Page No.
S804U-Z10	45								
S804U-Z100	45								
S804U-Z15	45								
S804U-Z20	45								
S804U-Z25	45								
S804U-Z30	45								
S804U-Z40	45								
S804U-Z50	45								
S804U-Z60	45								
S804U-Z70	45								
S804U-Z80	45								
S804U-Z90	45								
SZ-AST 50U	10								
SZ-AST 50UP	10								
SZ-AST 55U	10								
SZ-AST 55UP	10								
SZ-AST50I	31								
SZ-AST55I	31								
SZ-BSK	10, 31								
SZ-ESK2	31								

<i>Catalog No.</i>	<i>Page No.</i>	<i>Catalog No.</i>	<i>Page No.</i>	<i>Catalog No.</i>	<i>Page No.</i>	<i>Catalog No.</i>	<i>Page No.</i>	<i>Catalog No.</i>	<i>Page No.</i>
--------------------	-----------------	--------------------	-----------------	--------------------	-----------------	--------------------	-----------------	--------------------	-----------------

--	--	--	--	--	--	--	--	--	--

S200 UL 489 Series Miniature Circuit Breakers



S200
UL 489 Series



Description

The S200 Series miniature circuit breaker offers a compact solution for protection requirements. The S200 devices are UL tested current limiting and DIN rail mounted. The S200 is available with application-specific trip characteristics to provide maximum circuit protection. The breakers offer thermal-magnetic trip protection according to B, C, D, K and Z characteristics.

For the worldwide market, the breakers carry UL, CSA, IEC, CE and many other agency approvals and certifications.

Features

- Current limiting
- Fast breaking time (2.3 – 2.5 ms)
- Bus connection system
- Wide range of accessories
- Available with variable depth handle mechanism
- CE certified and marked
- DIN rail mounting
- Finger safe terminals
- Multi-function terminals
- Suitable for reverse feed
- UL 489 Listed - branch circuit protective device. UL File #E212323

	S200U	S200UP	S201DC
Amperage	0.2 – 63	0.2 – 25	1 – 25
Voltage	240 VAC	480Y/277VAC	60 VDC
Poles	1, 2, 3, 4	1, 2, 3, 4	1
Trip characteristics	K, Z	K, Z	K, Z
Interrupting ratings	10 kA: IEC 947-2 10 kA: UL 489 10 kA: CSA C22.2 No. 5	10 kA: IEC 947-2 10 kA: UL 489 10 kA: CSA C22.2 No. 5	10 kA: UL489 10 kA: CSA C22.2
Auxiliary contacts	Yes	Yes	Yes
Bell alarm	Yes	Yes	Yes
Shunt trip	Yes	Yes	Yes
Undervoltage release	No	No	No
Bus bar	Yes	Yes	Yes

S200U-K, 240 VAC

Branch circuit protection

UL 489, CSA C 22.2

K



S201U-K



S202U-K



S203U-K



S204U-K

No. of poles	Rated current	Catalog number	No. of poles	Rated current	Catalog number
1	0.2	S201U-K0.2	3	0.2	S203U-K0.2
	0.3	S201U-K0.3		0.3	S203U-K0.3
	0.5	S201U-K0.5		0.5	S203U-K0.5
	0.75	S201U-K0.75		0.75	S203U-K0.75
	1	S201U-K1		1	S203U-K1
	1.6	S201U-K1.6		1.6	S203U-K1.6
	2	S201U-K2		2	S203U-K2
	3	S201U-K3		3	S203U-K3
	4	S201U-K4		4	S203U-K4
	5	S201U-K5		5	S203U-K5
	6	S201U-K6		6	S203U-K6
	8	S201U-K8		8	S203U-K8
	10	S201U-K10		10	S203U-K10
	15	S201U-K15		15	S203U-K15
	16	S201U-K16		16	S203U-K16
	20	S201U-K20		20	S203U-K20
25	S201U-K25	25	S203U-K25		
30	S201U-K30	30	S203U-K30		
32	S201U-K32	32	S203U-K32		
40	S201U-K40	40	S203U-K40		
50	S201U-K50	50	S203U-K50		
60	S201U-K60	60	S203U-K60		
63	S201U-K63	63	S203U-K63		
2	0.2	S202U-K0.2	4	0.2	S204U-K0.2
	0.3	S202U-K0.3		0.3	S204U-K0.3
	0.5	S202U-K0.5		0.5	S204U-K0.5
	0.75	S202U-K0.75		0.75	S204U-K0.75
	1	S202U-K1		1	S204U-K1
	1.6	S202U-K1.6		1.6	S204U-K1.6
	2	S202U-K2		2	S204U-K2
	3	S202U-K3		3	S204U-K3
	4	S202U-K4		4	S204U-K4
	5	S202U-K5		5	S204U-K5
	6	S202U-K6		6	S204U-K6
	8	S202U-K8		8	S204U-K8
	10	S202U-K10		10	S204U-K10
	15	S202U-K15		15	S204U-K15
	16	S202U-K16		16	S204U-K16
	20	S202U-K20		20	S204U-K20
25	S202U-K25	25	S204U-K25		
30	S202U-K30	30	S204U-K30		
32	S202U-K32	32	S204U-K32		
40	S202U-K40	40	S204U-K40		
50	S202U-K50	50	S204U-K50		
60	S202U-K60	60	S204U-K60		
63	S202U-K63	63	S204U-K63		

Tripping characteristic K

UL 489
240 VAC
10 kA

Inductive loads

- K Curve
- Designed for allowing higher in-rush currents during system start up
- Example: motors, transformers

Accessories & technical data

Accessories – See page 7

Technical data – See page 76 - 82

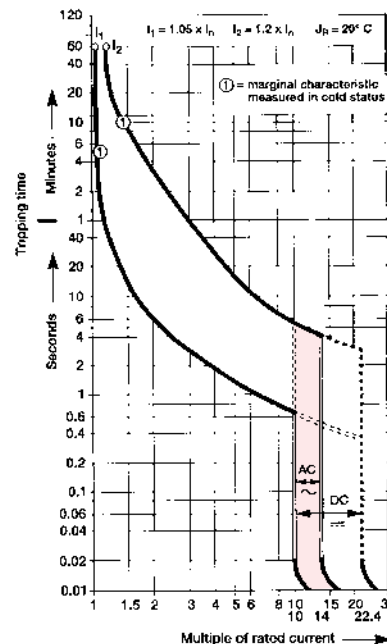

Note: This breaker for AC use only

S200U-Z, 240 VAC

Branch circuit protection

UL 489, CSA C 22.2

Miniature
circuit breakers

Z



S201U-Z



S202U-Z



S203U-Z



S204U-Z

No. of poles	Rated current	Catalog number	No. of poles	Rated current	Catalog number
1	0.5	S201U-Z0.5	3	0.5	S203U-Z0.5
	1	S201U-Z1		1	S203U-Z1
	1.6	S201U-Z1.6		1.6	S203U-Z1.6
	2	S201U-Z2		2	S203U-Z2
	3	S201U-Z3		3	S203U-Z3
	4	S201U-Z4		4	S203U-Z4
	5	S201U-Z5		5	S203U-Z5
	6	S201U-Z6		6	S203U-Z6
	8	S201U-Z8		8	S203U-Z8
	10	S201U-Z10		10	S203U-Z10
	15	S201U-Z15		15	S203U-Z15
	16	S201U-Z16		16	S203U-Z16
	20	S201U-Z20		20	S203U-Z20
	25	S201U-Z25		25	S203U-Z25
	30	S201U-Z30		30	S203U-Z30
32	S201U-Z32	32	S203U-Z32		
40	S201U-Z40	40	S203U-Z40		
50	S201U-Z50	50	S203U-Z50		
60	S201U-Z60	60	S203U-Z60		
63	S201U-Z63	63	S203U-Z63		
2	0.5	S202U-Z0.5	4	0.5	S204U-Z0.5
	1	S202U-Z1		1	S204U-Z1
	1.6	S202U-Z1.6		1.6	S204U-Z1.6
	2	S202U-Z2		2	S204U-Z2
	3	S202U-Z3		3	S204U-Z3
	4	S202U-Z4		4	S204U-Z4
	5	S202U-Z5		5	S204U-Z5
	6	S202U-Z6		6	S204U-Z6
	8	S202U-Z8		8	S204U-Z8
	10	S202U-Z10		10	S204U-Z10
	15	S202U-Z15		15	S204U-Z15
	16	S202U-Z16		16	S204U-Z16
	20	S202U-Z20		20	S204U-Z20
	25	S202U-Z25		25	S204U-Z25
	30	S202U-Z30		30	S204U-Z30
32	S202U-Z32	32	S204U-Z32		
40	S202U-Z40	40	S204U-Z40		
50	S202U-Z50	50	S204U-Z50		
60	S202U-Z60	60	S204U-Z60		
63	S202U-Z63	63	S204U-Z63		

Tripping characteristic Z

UL 489
240 VAC
10 kA

Resistive loads

- Z Curve
- Designed to provide maximum protection with a very low short circuit trip setting
- Example: semiconductors
- Control circuits

Accessories & technical data

Accessories – See page 7

Technical data – See page 76 - 82

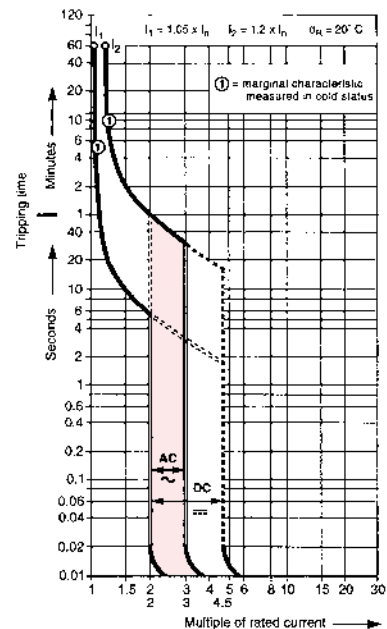

Note: This breaker for AC use only

S200UP-K, 480Y/277 VAC

Branch circuit protection

UL 489, CSA C 22.2

K



S201UP-K



S202UP-K



S203UP-K



S204UP-K

No. of poles	Rated current	Catalog number	No. of poles	Rated current	Catalog number
1	0.2	S201UP-K0.2	3	0.2	S203UP-K0.2
	0.3	S201UP-K0.3		0.3	S203UP-K0.3
	0.5	S201UP-K0.5		0.5	S203UP-K0.5
	0.75	S201UP-K0.75		0.75	S203UP-K0.75
	1	S201UP-K1		1	S203UP-K1
	1.6	S201UP-K1.6		1.6	S203UP-K1.6
	2	S201UP-K2		2	S203UP-K2
	3	S201UP-K3		3	S203UP-K3
	4	S201UP-K4		4	S203UP-K4
	5	S201UP-K5		5	S203UP-K5
	6	S201UP-K6		6	S203UP-K6
	8	S201UP-K8		8	S203UP-K8
	10	S201UP-K10		10	S203UP-K10
15	S201UP-K15	15	S203UP-K15		
16	S201UP-K16	16	S203UP-K16		
20	S201UP-K20	20	S203UP-K20		
25	S201UP-K25	25	S203UP-K25		
2	0.2	S202UP-K0.2	4	0.2	S204UP-K0.2
	0.3	S202UP-K0.3		0.3	S204UP-K0.3
	0.5	S202UP-K0.5		0.5	S204UP-K0.5
	0.75	S202UP-K0.75		0.75	S204UP-K0.75
	1	S202UP-K1		1	S204UP-K1
	1.6	S202UP-K1.6		1.6	S204UP-K1.6
	2	S202UP-K2		2	S204UP-K2
	3	S202UP-K3		3	S204UP-K3
	4	S202UP-K4		4	S204UP-K4
	5	S202UP-K5		5	S204UP-K5
	6	S202UP-K6		6	S204UP-K6
	8	S202UP-K8		8	S204UP-K8
	10	S202UP-K10		10	S204UP-K10
15	S202UP-K15	15	S204UP-K15		
16	S202UP-K16	16	S204UP-K16		
20	S202UP-K20	20	S204UP-K20		
25	S202UP-K25	25	S204UP-K25		

Tripping characteristic K

UL 489
480Y/277 VAC
10 kA

Inductive loads

- K Curve
- Designed for allowing higher in-rush currents during system start up
- Example: motors, transformers

Accessories & technical data

Accessories – See page 7

Technical data – See page 76 - 82

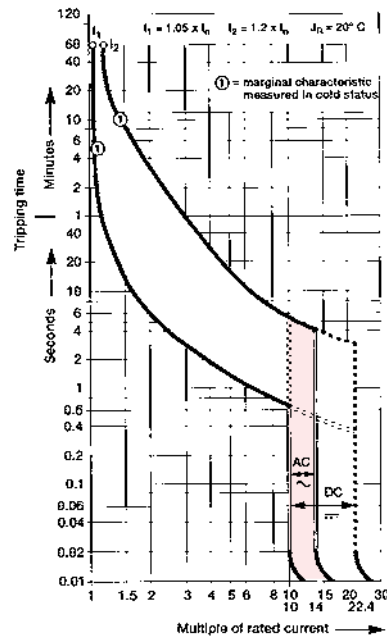

Note: This breaker for AC use only

S200UP-Z, 277/480Y/277 VAC

Branch circuit protection

UL 489, CSA C 22.2

Miniature
circuit breakers

Z



S201UP-Z



S202UP-Z



S203UP-Z



S204UP-Z

No. of poles	Rated current	Catalog number	No. of poles	Rated current	Catalog number
1	0.5	S201UP-Z0.5	3	0.5	S203UP-Z0.5
	1	S201UP-Z1		1	S203UP-Z1
	1.6	S201UP-Z1.6		1.6	S203UP-Z1.6
	2	S201UP-Z2		2	S203UP-Z2
	3	S201UP-Z3		3	S203UP-Z3
	4	S201UP-Z4		4	S203UP-Z4
	5	S201UP-Z5		5	S203UP-Z5
	6	S201UP-Z6		6	S203UP-Z6
	8	S201UP-Z8		8	S203UP-Z8
	10	S201UP-Z10		10	S203UP-Z10
	15	S201UP-Z15		15	S203UP-Z15
2	0.5	S202UP-Z0.5	4	0.5	S204UP-Z0.5
	1	S202UP-Z1		1	S204UP-Z1
	1.6	S202UP-Z1.6		1.6	S204UP-Z1.6
	2	S202UP-Z2		2	S204UP-Z2
	3	S202UP-Z3		3	S204UP-Z3
	4	S202UP-Z4		4	S204UP-Z4
	5	S202UP-Z5		5	S204UP-Z5
	6	S202UP-Z6		6	S204UP-Z6
	8	S202UP-Z8		8	S204UP-Z8
	10	S202UP-Z10		10	S204UP-Z10
	15	S202UP-Z15		15	S204UP-Z15
16	S202UP-Z16	16	S204UP-Z16		
20	S202UP-Z20	20	S204UP-Z20		
25	S202UP-Z25	25	S204UP-Z25		

Tripping characteristic Z

UL 489

480Y/277 VAC

10 kA

Resistive loads

- Z Curve
- Designed to provide maximum protection with a very low short circuit trip setting
- Example: semiconductors
- Control circuits

Accessories & technical data

Accessories – See page 7

Technical data – See page 76 - 82

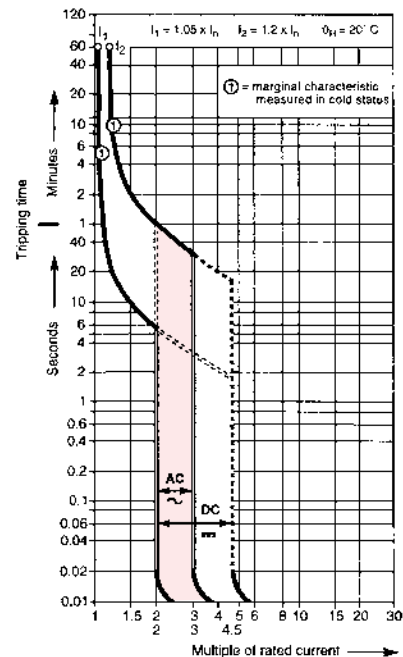

Note: This breaker for AC use only

S201DC, 60 VDC

Branch circuit protection
UL 489, CSA C 22.2

K, Z



S201DC-K



S201DC-Z

No. of poles	Rated current	Catalog number
1	1	S201DC-K1
	1.6	S201DC-K1.6
	2	S201DC-K2
	3	S201DC-K3
	4	S201DC-K4
	6	S201DC-K6
	8	S201DC-K8
	10	S201DC-K10
	13	S201DC-K13
	16	S201DC-K16
1	1	S201DC-Z1
	1.6	S201DC-Z1.6
	2	S201DC-Z2
	3	S201DC-Z3
	4	S201DC-Z4
	6	S201DC-Z6
	8	S201DC-Z8
	10	S201DC-Z10
	16	S201DC-Z16
	20	S201DC-Z20
25	S201DC-Z25	

Tripping characteristic K

UL 489
60 VDC
10 kA

Inductive loads

- K Curve
- Designed for allowing higher in-rush currents during system start up
- Example: motors, transformers

Accessories & technical data

Accessories – See page 7

Technical data – See page 76 - 82

Tripping characteristic Z

UL 489
60 VDC
10 kA

Resistive loads

- Z Curve
- Designed to provide maximum protection with a very low short circuit trip setting

Accessories & technical data

Accessories – See page 7

Technical data – See page 76 - 82

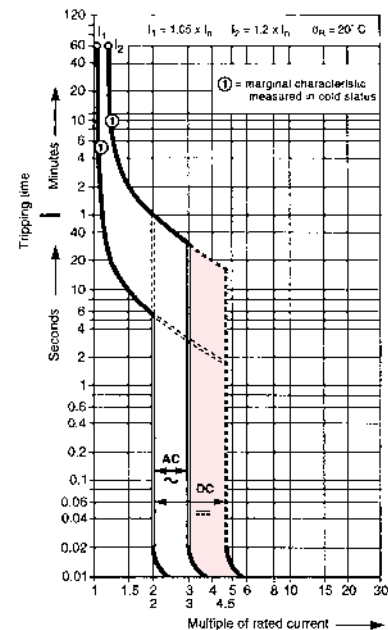
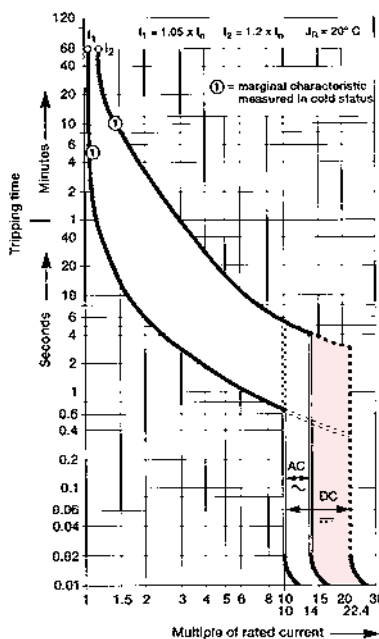
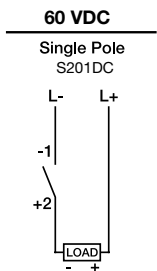

Note: This breaker for DC use only.

Accessories

S200U, S200UP & S201DC

UL 489, CSA C 22.2



S2C-H6RU

Auxiliary contacts

The auxiliary contacts will signal whether the breaker is in the ON or OFF position.

Description	Catalog number
For field mounting: right side	S2C-H6RU

Bell alarm

The bell alarm includes a set of contacts that will only signal when the breaker has tripped. Typically the contacts would be connected to an alarm or bell to signal the operator that an overcurrent trip has occurred. The bell alarm also includes a test button for testing the alarm contacts without opening the breaker.

Description	Catalog number
For field mounting: right side	S2C-S6RU



S2C-S6RU

Rotary operating mechanism

Allows "through the door" operation.

Description	Catalog number
Handle mechanism	S2C-DH

Shunt trip

For remote tripping of breaker, a shunt trip device can be added to the MCB. The solenoid device opens the breaker after control voltage is applied.

Description	Catalog number
For field mounting: right side 12...60 VAC/DC	S2C-A1U
For field mounting: right side 110...415 VAC 110...250 VDC	S2C-A2U



S2C-A1U

Possible mounting arrangements of MCB accessories

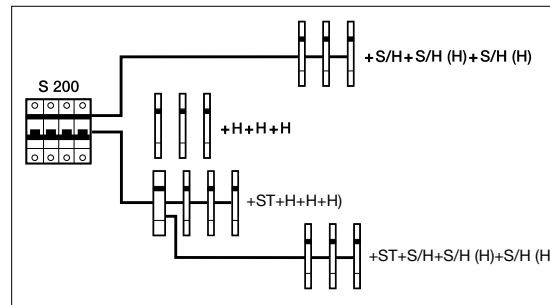

Legend	
Auxiliary contact	H
Bell alarm/Auxiliary contact	S/H
Bell alarm/Auxiliary contact used as auxiliary contact	S/H (H)
Shunt trip	ST



S2C-DH

Accessories

S200U, S200UP & S201DC

UL 489, CSA C 22.2

Connection drawings

Bell alarm S2C-S6RU

In ON and OFF position after hand operation

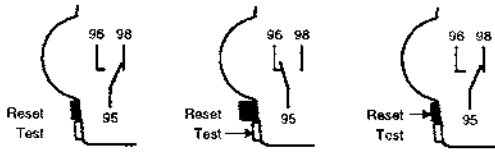

In OFF position after tripping

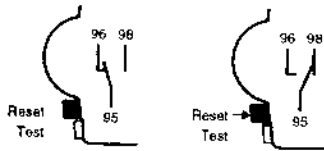

Auxiliary contact S2C-H6RU

Auxiliary contact in ON position

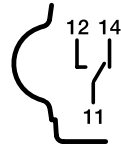

Auxiliary contact in OFF position

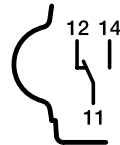

Shunt trip S2C-A...U

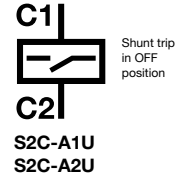

Approximate dimensions in mm

S200U

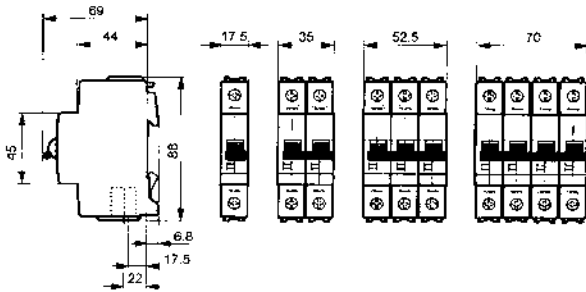

S2C-H6RU, S2C-S6RU S2C-A..U

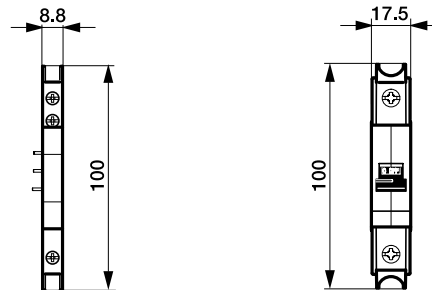

S200UP

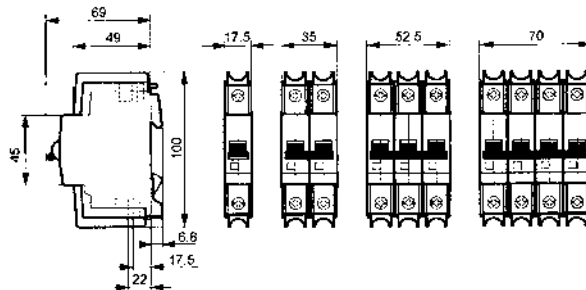

S201DC

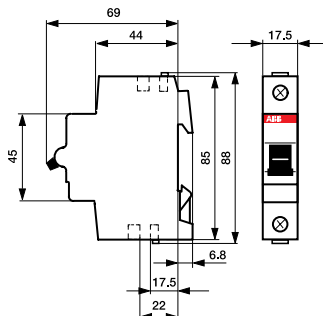

Accessories

S200U, S200UP & S201DC
UL 489, CSA C 22.2

Miniature
circuit breakers

Mounting

Addition of a S2C-H6RU auxiliary contact

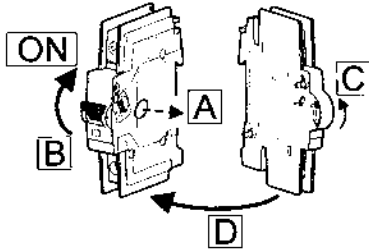

Addition of a S2C-S6RU bell alarm contact

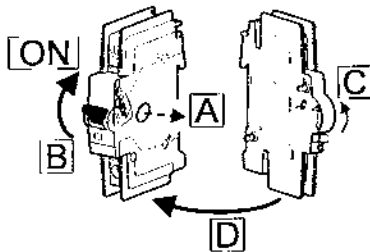

Addition of a S2C-A..U shunt trip

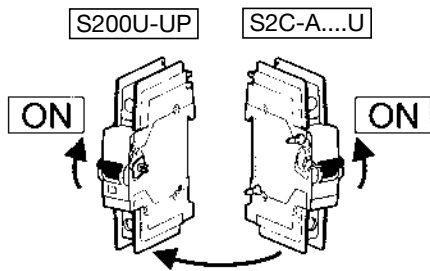

Accessories

S200U, S200UP & S201DC

UL 489, CSA C 22.2

UL approved busbars UL file # E250145

UL 489 busbar cannot be cut.

1 Phase

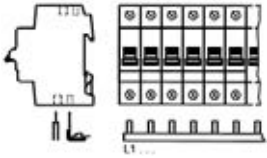

2 Phase

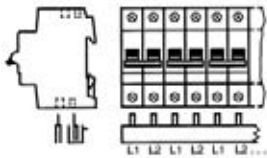

3 Phase

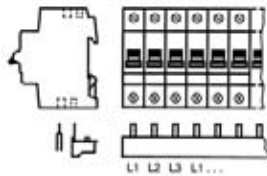

For use on:	Amp rating	Number of poles	Phases	Busbar length (mm)	Catalog number
S200U	80	6	1	103.2	PS 1/6/16BP
S200UP		12	1	208.8	PS 1/12/16BP
S201DC		18	1	314.4	PS 1/18/16BP
S200U	80	6	2	103.2	PS 2/6/16BP
S200UP		12	2	208.8	PS 2/12/16BP
S201DC		18	2	314.4	PS 2/18/16BP
S200U	80	6	3	103.2	PS 3/6/16BP
S200UP		12	3	208.8	PS 3/12/16BP
S201DC		18	3	314.4	PS 3/18/16BP

Busbar tooth covers

Description	Catalog number
Covers five unused poles of Busbar	SZ-BSK

Feeder terminals

for S200U

Max wire AWG	Description	Catalog number
1/0	angled feeding	SZ-AST 50U
1/0	straight feeding	SZ-AST 55U

for S200UP

Max wire AWG	Description	Catalog number
1/0	angled feeding	SZ-AST 50UP
1/0	straight feeding	SZ-AST 55UP

Dimension drawings in mm

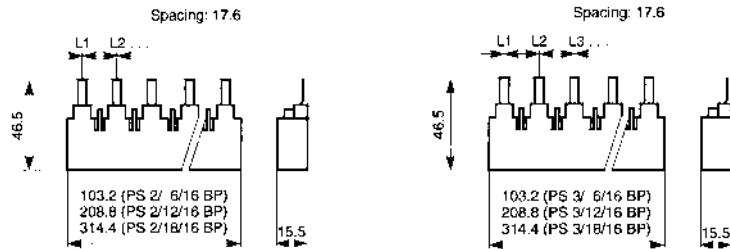

BUSBARS MAY BE USED ON BOTH
SIDES OF MCBS



SZ-BSK

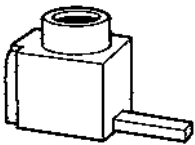

SZ-AST55U

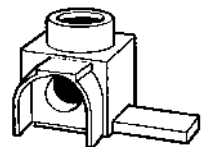

SZ-AST50UP

Technical data

S200U, S200UP & S201DC

UL 489, CSA C 22.2

Miniature
circuit breakers

Technical data	S200U	S200UP	S201DC
Specifications:	UL 489, CSA C 22.2 No. 5, IEC 60 947-2		UL 489, CSA C 22.2, VDE 0660
UL File-Number:	E 2123233, UL, Current limiting series ratings		
No. of poles:	1, 2, 3 & 4		1
Tripping characteristics:	K & Z		K, Z
Rated current:	0.2 (K) 0.5 (Z) ... 63 A	0.2 (K) 0.5 (Z) ... 25 A	1 - 25 A
Rated voltage:	1-pole: 240VAC Multi pole: 240VAC	1-pole: 277VAC Multi pole: 480Y/277VAC	
Short circuit capacity:	10 kA		10 kA
Frequency:	50/60 Hz		50/60 Hz
Degree of protection:	IP 20		IP 20
Mounting position:	Vertical and horizontal		Vertical and horizontal
Fixing:	35 mm DIN rail		35 mm DIN rail
Clamps only for Cu:	18 ... 4 AWG (0.75 ... 25 mm ²)		18 ... 4 AWG (0.75 ... 25 mm ²)
Service life, mech. and at rated load:	20,000 operations		10,000 operations
Tightening torque:	25 in. lbs (2.8 Nm)		4.5 in. lbs
Ambient temperature:	- 25 ... + 55 °C/- 13 °F ... + 131 °F		- 40 ... + 70 °C/- 40 °F ... + 158 °F
Shock resistance:	10 g at least 2 impacts shock duration 13 ms		10 g at least 2 impacts shock duration 13 ms

Auxiliary contact S2C-H6RL and S2C-S6RU

Rated current:	10
Rated voltage AC / DC:	24
Contact:	1 pole single throw
Connection capacity mm ²	18 - 14 AWG (0.75...2.5 mm ²)
Tightening torque:	11 in.lbs (1.2 Nm)
Shock resistance acc. to DIN IEC 68-2-6:	5 g, 20 frequency cycles 5...150...5 Hz at 24 VAC/DC, 5 mA auto-reclosing < 10 ms
Mechanical service life:	10,000 operations

Shunt trip			S2C-A1U	S2C-A2U
Rated voltage	AC	V	12 ... 60	110 ... 415
	DC	V	12 ... 60	110 ... 250
Max. release duration		ms	<10	<10
Min. release voltage	AC	V	7	55
	DC	V	10	80
Consumption on release	AC	VA	40 ... 200	55 ... 210
	DC	VA	40 ... 200	55 ... 110
Coil resistance		Ω	3.7	225
Terminals		AWG/mm ²	18...6 / 0.75 - 16	18...6 / 0.75 - 16
Tightening torque		in.lbs/Nm	18 / 2	18 / 2

Technical data

S200U, S200UP & S201DC

UL 489, CSA C 22.2

Internal resistance and power loss

Internal resistance per pole in mΩ, power loss per pole in W.

Type	Rated current A	Device series K		Device series Z	
		mΩ	W	mΩ	W
S200U S200UP S201DC	0.2	42500	1.7	–	–
	0.3	20000	1.8	–	–
	0.5	6340	1.6	10100	2.5
	0.75	2500	1.4	–	–
	1	1400	1.4	2270	2.3
	1.6	625	1.6	1100	2.8
	2	460	1.8	619	2.5
	3	211	1.9	211	1.9
	4	163	2.6	163	2.6
	6	67	2.4	104	3.7
	8	45	2.9	55	3.5
	10	19	1.9	21	2.1
	13	–	–	–	–
	16	8.2	2.1	10.9	2.8
	20	7.3	2.9	7.3	2.9
	25	5.6	3.5	5.6	3.5
	32	4.1	4.2	4.1	4.2
	40	4.0	6.4	4.0	6.4
50	1.2	3.0	1.8	4.4	
63	1.3	5.2	1.3	5.2	

Technical data

S200U & S200UP

UL 489, CSA C 22.2

Miniature
circuit breakers

Tripping characteristic K (68 °F)

Breaker calibration temperature 68°F
See chart below for temperature DeRating

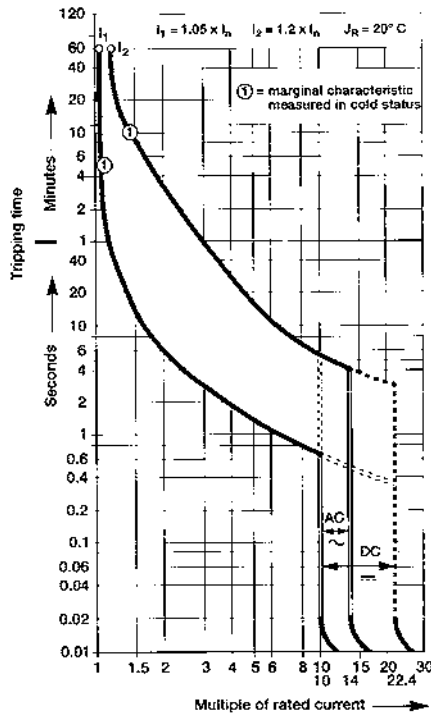

Tripping characteristic Z (68 °F)

Breaker calibration temperature 68°F
See chart below for temperature DeRating

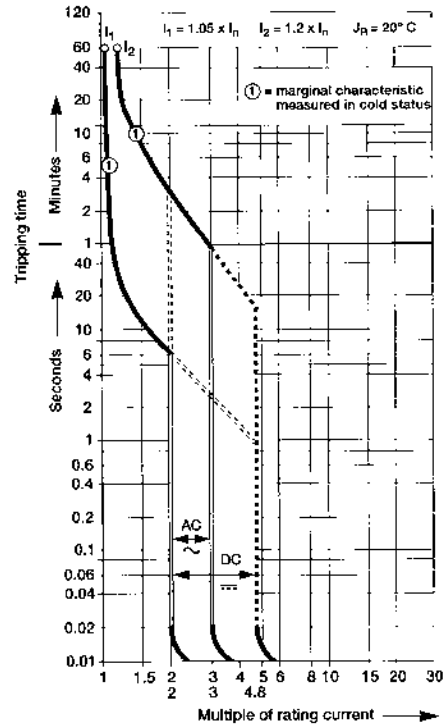

Temperature derating

Max. operating current values depending on the ambient temperature for a circuit-breaker of characteristics type K and Z

K and Z I_n (A)	Ambient temperature T (°C/°F)												
	-40/-40	-30/-22	-20/-4	-10/14	0/32	10/50	20/68	30/86	40/104	50/122	60/140	70/158	
0.5	0.66	0.64	0.61	0.59	0.56	0.53	0.50	0.47	0.43	0.40	0.35	0.31	
1.0	1.32	1.27	1.22	1.17	1.12	1.06	1.00	0.94	0.87	0.79	0.71	0.61	
1.6	2.12	2.04	1.96	1.88	1.79	1.70	1.60	1.50	1.39	1.26	1.13	0.98	
2.0	2.65	2.55	2.45	2.35	2.24	2.12	2.00	1.87	1.73	1.58	1.41	1.22	
3.0	4.0	3.8	3.7	3.5	3.4	3.2	3.0	2.8	2.6	2.4	2.1	1.8	
4.0	5.3	5.1	4.9	4.7	4.5	4.2	4.0	3.7	3.5	3.2	2.8	2.4	
6.0	7.9	7.6	7.3	7.0	6.7	6.4	6.0	5.6	5.2	4.7	4.2	3.7	
8.0	10.8	10.2	9.8	9.4	8.9	8.5	8.0	7.5	6.9	6.3	5.7	4.9	
10.0	13.2	12.7	12.2	11.7	11.2	10.6	10.0	9.4	8.7	7.9	7.1	6.1	
13.0	17.2	16.6	15.9	15.2	14.5	13.8	13.0	12.2	11.3	10.3	9.2	8.0	
16.0	21.2	20.4	19.6	18.8	17.9	17.0	16.0	15.0	13.9	12.6	11.3	9.8	
20.0	26.5	25.5	24.5	23.5	22.4	21.2	20.0	18.7	17.3	15.8	14.1	12.2	
25.0	33.1	31.9	30.6	29.3	28.0	26.5	25.0	23.4	21.7	19.8	17.7	15.3	
32.0	42.3	40.8	39.2	37.5	35.8	33.9	32.0	29.9	27.7	25.3	22.6	19.6	
40.0	52.9	51.0	49.0	46.9	44.7	42.4	40.0	37.4	34.6	31.6	28.3	24.5	
50.0	66.1	63.7	61.2	58.6	55.9	53.0	50.0	46.8	43.3	39.5	35.4	30.6	
63.0	83.3	80.3	77.2	73.9	70.4	66.8	63.0	58.9	54.6	49.8	44.5	38.6	

S200 Series Miniature Circuit Breakers



S200
UL 1077 Series



Description

The S200 Series miniature circuit breaker offers a compact solution for protection requirements. The S200 devices are UL tested current limiting and DIN rail mounted. The S200 is available with application-specific trip characteristics to provide maximum circuit protection. The breakers offer thermal-magnetic trip protection according to B, C, D, K and Z characteristics.

For the worldwide market, the breakers carry UL, CSA, IEC, CE and many other agency approvals and certifications.

Features

- Current limiting
- Fast breaking time (2.3 – 2.5 ms)
- Bus connection system
- Wide range of accessories
- Available with variable depth handle mechanism
- CE certified and marked
- DIN rail mounting
- Finger safe terminals
- Multi-function terminals
- Suitable for reverse feed
- UL1077 Listed-supplemental protective device. UL file # E76126

	S200	S200P	S280UC	S290
Amperage	0.5 – 63 A	0.2 – 63 A	0.2 – 63 A	80 - 125 A
Voltage	480Y/277 VAC	480Y/277 VAC	500 VDC	480Y/277 VAC
Poles	1, 2, 3, 4	1, 2, 3, 4	1, 2, 3	1, 2, 3, 4
Trip characteristics	B, C, D, K	K, Z	K, Z	C
Interrupting ratings	6 kA: IEC 60898 6 kA: UL 1077 6 kA: CSA C22.2 #235	10kA: IEC 947-2 10kA: UL 1077	10kA: IEC 947 10kA: UL 1077	6 kA: IEC 898 6 kA: UL 1077
Auxiliary contacts	Yes	Yes	Yes	Yes
Bell alarm	Yes	Yes	Yes	Yes
Shunt trip	Yes	Yes	Yes	Yes
Undervoltage release	Yes	Yes	Yes	No
Bus bar	Yes	Yes	Yes	No

S200-B, 480Y/277 VAC

Supplemental protectors

UL 1077, CSA 22.2

B



S201-B



S202-B

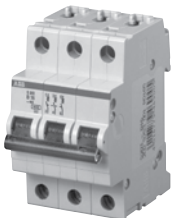

S203-B



S204-B



S201-BNA



S203-BNA

No. of poles	Rated current	Catalog number	No. of poles	Rated current	Catalog number
1	6	S201-B6	3	6	S203-B6
	10	S201-B10		10	S203-B10
	13	S201-B13		13	S203-B13
	16	S201-B16		16	S203-B16
	20	S201-B20		20	S203-B20
	25	S201-B25		25	S203-B25
	32	S201-B32		32	S203-B32
	40	S201-B40		40	S203-B40
	50	S201-B50		50	S203-B50
63	S201-B63	63	S203-B63		
1 + NA	6	S201-B6NA	3 + NA	6	S203-B6NA
	10	S201-B10NA		10	S203-B10NA
	13	S201-B13NA		13	S203-B13NA
	16	S201-B16NA		16	S203-B16NA
	20	S201-B20NA		20	S203-B20NA
	25	S201-B25NA		25	S203-B25NA
	32	S201-B32NA		32	S203-B32NA
	40	S201-B40NA		40	S203-B40NA
	50	S201-B50NA		50	S203-B50NA
63	S201-B63NA	63	S203-B63NA		
2	6	S202-B6	4	6	S204-B6
	10	S202-B10		10	S204-B10
	13	S202-B13		13	S204-B13
	16	S202-B16		16	S204-B16
	20	S202-B20		20	S204-B20
	25	S202-B25		25	S204-B25
	32	S202-B32		32	S204-B32
	40	S202-B40		40	S204-B40
	50	S202-B50		50	S204-B50
63	S202-B63	63	S204-B63		

Tripping characteristic B

UL 1077
480Y/277VAC
6 kA

Resistive loads

- B Curve
- Designed for use in cable protection applications
- Example: control circuits, lighting

Accessories & technical data

Accessories – See page 26
Technical data – See page 76 - 82

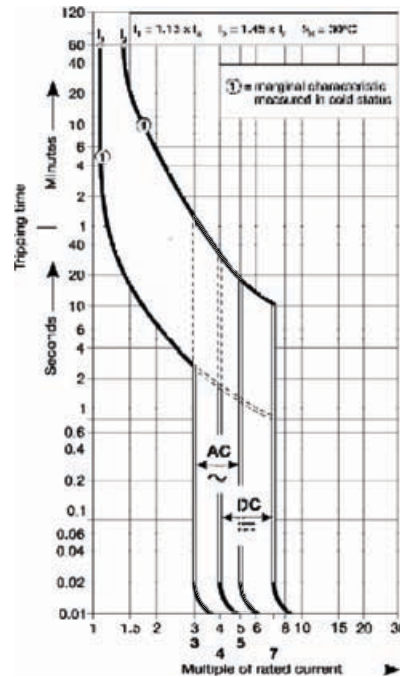

Note: This breaker for AC use only. Switching neutral is noted by "NA" in the catalog number.

S200-C, 480Y/277 VAC

Supplemental protectors

UL 1077, CSA 22.2

Miniature
circuit breakers

C



S201-C



S202-C



S203-C

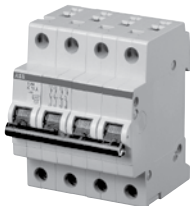

S204-C



S201-CNA



S203-CNA

No. of poles	Rated current	Catalog number	No. of poles	Rated current	Catalog number
1	0.5	S201-C0.5	3	0.5	S203-C0.5
	1	S201-C1		1	S203-C1
	1.6	S201-C1.6		1.6	S203-C1.6
	2	S201-C2		2	S203-C2
	3	S201-C3		3	S203-C3
	4	S201-C4		4	S203-C4
	6	S201-C6		6	S203-C6
	8	S201-C8		8	S203-C8
	10	S201-C10		10	S203-C10
	13	S201-C13		13	S203-C13
	16	S201-C16		16	S203-C16
	20	S201-C20		20	S203-C20
	25	S201-C25		25	S203-C25
	32	S201-C32		32	S203-C32
	40	S201-C40		40	S203-C40
	50	S201-C50		50	S203-C50
63	S201-C63	63	S203-C63		
1 + NA	0.5	S201-C0.5NA	3 + NA	0.5	S203-C0.5NA
	1	S201-C1NA		1	S203-C1NA
	1.6	S201-C1.6NA		1.6	S203-C1.6NA
	2	S201-C2NA		2	S203-C2NA
	3	S201-C3NA		3	S203-C3NA
	4	S201-C4NA		4	S203-C4NA
	6	S201-C6NA		6	S203-C6NA
	8	S201-C8NA		8	S203-C8NA
	10	S201-C10NA		10	S203-C10NA
	13	S201-C13NA		13	S203-C13NA
	16	S201-C16NA		16	S203-C16NA
	20	S201-C20NA		20	S203-C20NA
	25	S201-C25NA		25	S203-C25NA
	32	S201-C32NA		32	S203-C32NA
	40	S201-C40NA		40	S203-C40NA
	50	S201-C50NA		50	S203-C50NA
63	S201-C63NA	63	S203-C63NA		
2	0.5	S202-C0.5	4	0.5	S204-C0.5
	1	S202-C1		1	S204-C1
	1.6	S202-C1.6		1.6	S204-C1.6
	2	S202-C2		2	S204-C2
	3	S202-C3		3	S204-C3
	4	S202-C4		4	S204-C4
	6	S202-C6		6	S204-C6
	8	S202-C8		8	S204-C8
	10	S202-C10		10	S204-C10
	13	S202-C13		13	S204-C13
	16	S202-C16		16	S204-C16
	20	S202-C20		20	S204-C20
	25	S202-C25		25	S204-C25
	32	S202-C32		32	S204-C32
	40	S202-C40		40	S204-C40
	50	S202-C50		50	S204-C50
63	S202-C63	63	S204-C63		

Tripping characteristic C

UL 1077
480Y/277 VAC
6 kA

Resistive loads

- C Curve
- Designed for use with medium magnetic start up currents
- Example: lighting, control panels

Accessories & technical data

Accessories – See page 26

Technical data – See page 76 - 82

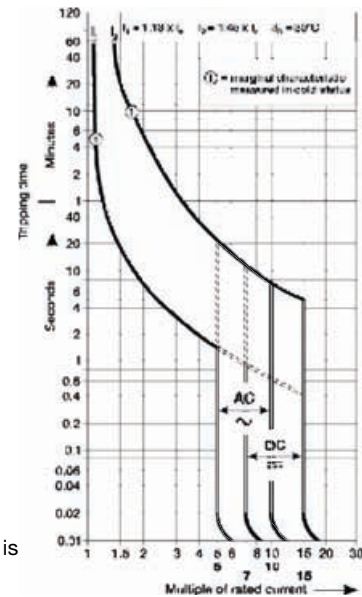

Note: This breaker for AC use only. Switching neutral is noted by "NA" in the catalog number.

S200-D, 480Y/277 VAC

Supplemental protectors

UL 1077, CSA 22.2

D



S201-D



S202-D

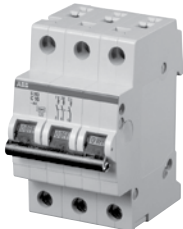

S203-D

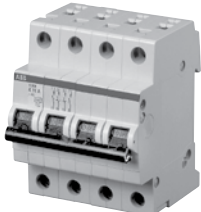

S204-D



S201-DNA

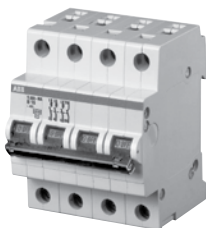

S203-DNA

No. of poles	Rated current	Catalog number	No. of poles	Rated current	Catalog number
1	0.5	S201-D0.5	3	0.5	S203-D0.5
	1	S201-D1		1	S203-D1
	1.6	S201-D1.6		1.6	S203-D1.6
	2	S201-D2		2	S203-D2
	3	S201-D3		3	S203-D3
	4	S201-D4		4	S203-D4
	6	S201-D6		6	S203-D6
	8	S201-D8		8	S203-D8
	10	S201-D10		10	S203-D10
	13	S201-D13		13	S203-D13
	16	S201-D16		16	S203-D16
	20	S201-D20		20	S203-D20
	25	S201-D25		25	S203-D25
	32	S201-D32		32	S203-D32
	40	S201-D40		40	S203-D40
	50	S201-D50		50	S203-D50
63	S201-D63	63	S203-D63		
1 + NA	0.5	S201-D0.5NA	3 + NA	0.5	S203-D0.5NA
	1	S201-D1NA		1	S203-D1NA
	1.6	S201-D1.6NA		1.6	S203-D1.6NA
	2	S201-D2NA		2	S203-D2NA
	3	S201-D3NA		3	S203-D3NA
	4	S201-D4NA		4	S203-D4NA
	6	S201-D6NA		6	S203-D6NA
	8	S201-D8NA		8	S203-D8NA
	10	S201-D10NA		10	S203-D10NA
	13	S201-D13NA		13	S203-D13NA
	16	S201-D16NA		16	S203-D16NA
	20	S201-D20NA		20	S203-D20NA
	25	S201-D25NA		25	S203-D25NA
	32	S201-D32NA		32	S203-D32NA
	40	S201-D40NA		40	S203-D40NA
	50	S201-D50NA		50	S203-D50NA
63	S201-D63NA	63	S203-D63NA		
2	0.5	S202-D0.5	4	0.5	S204-D0.5
	1	S202-D1		1	S204-D1
	1.6	S202-D1.6		1.6	S204-D1.6
	2	S202-D2		2	S204-D2
	3	S202-D3		3	S204-D3
	4	S202-D4		4	S204-D4
	6	S202-D6		6	S204-D6
	8	S202-D8		8	S204-D8
	10	S202-D10		10	S204-D10
	13	S202-D13		13	S204-D13
	16	S202-D16		16	S204-D16
	20	S202-D20		20	S204-D20
	25	S202-D25		25	S204-D25
	32	S202-D32		32	S204-D32
	40	S202-D40		40	S204-D40
	50	S202-D50		50	S204-D50
63	S202-D63	63	S204-D63		

Tripping characteristic D

UL 1077
480Y/277 VAC
6 kA

Inductive loads

- D Curve
- Designed for allowing higher in-rush currents during system start up
- Example: motors, transformers

Accessories & technical data

Accessories – See page 26

Technical data – See page 76 - 82

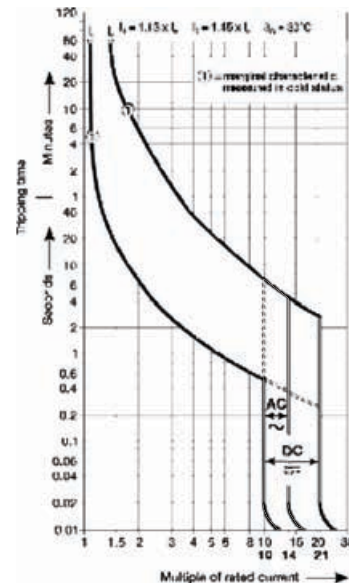

Note: This breaker for AC use only

S200-K, 480Y/277 VAC

Supplemental protectors

UL 1077, CSA 22.2

K



S201-K



S202-K



S203-K



S204-K



S201-KNA



S203-KNA

No. of poles	Rated current	Catalog number	No. of poles	Rated current	Catalog number
1	0.5	S201-K0.5	3	0.5	S203-K0.5
	1	S201-K1		1	S203-K1
	1.6	S201-K1.6		1.6	S203-K1.6
	2	S201-K2		2	S203-K2
	3	S201-K3		3	S203-K3
	4	S201-K4		4	S203-K4
	6	S201-K6		6	S203-K6
	8	S201-K8		8	S203-K8
	10	S201-K10		10	S203-K10
	13	S201-K13		13	S203-K13
	16	S201-K16		16	S203-K16
	20	S201-K20		20	S203-K20
	25	S201-K25		25	S203-K25
	32	S201-K32		32	S203-K32
40	S201-K40	40	S203-K40		
50	S201-K50	50	S203-K50		
63	S201-K63	63	S203-K63		
1 + NA	0.5	S201-K0.5NA	3 + NA	0.5	S203-K0.5NA
	1	S201-K1NA		1	S203-K1NA
	1.6	S201-K1.6NA		1.6	S203-K1.6NA
	2	S201-K2NA		2	S203-K2NA
	3	S201-K3NA		3	S203-K3NA
	4	S201-K4NA		4	S203-K4NA
	6	S201-K6NA		6	S203-K6NA
	8	S201-K8NA		8	S203-K8NA
	10	S201-K10NA		10	S203-K10NA
	13	S201-K13NA		13	S203-K13NA
	16	S201-K16NA		16	S203-K16NA
	20	S201-K20NA		20	S203-K20NA
	25	S201-K25NA		25	S203-K25NA
	32	S201-K32NA		32	S203-K32NA
40	S201-K40NA	40	S203-K40NA		
50	S201-K50NA	50	S203-K50NA		
63	S201-K63NA	63	S203-K63NA		
2	0.5	S202-K0.5	4	0.5	S204-K0.5
	1	S202-K1		1	S204-K1
	1.6	S202-K1.6		1.6	S204-K1.6
	2	S202-K2		2	S204-K2
	3	S202-K3		3	S204-K3
	4	S202-K4		4	S204-K4
	6	S202-K6		6	S204-K6
	8	S202-K8		8	S204-K8
	10	S202-K10		10	S204-K10
	13	S202-K13		13	S204-K13
	16	S202-K16		16	S204-K16
	20	S202-K20		20	S204-K20
	25	S202-K25		25	S204-K25
	32	S202-K32		32	S204-K32
40	S202-K40	40	S204-K40		
50	S202-K50	50	S204-K50		
63	S202-K63	63	S204-K63		

Tripping characteristic K

UL 1077

480Y/277 VAC

6 kA

Inductive loads

- K Curve
- Designed for allowing higher in-rush currents during system start up
- Example: motors, transformers

Accessories & technical data

Accessories – See page 26

Technical data – See page 76 - 82

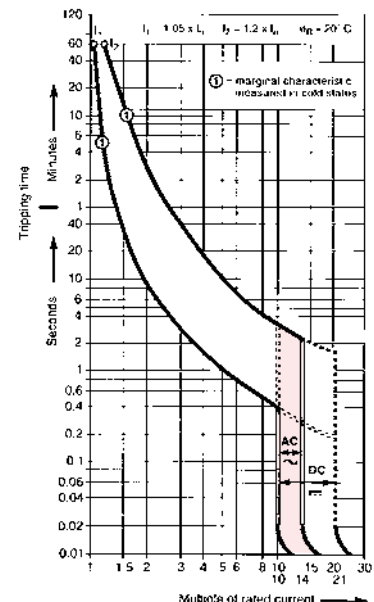

Note: This breaker for AC use only

S200P-K, 480Y/277 VAC

Supplemental protectors

UL 1077, CSA 22.2

K



S201P-K



S202P-K



S203P-K

No. of poles	Rated current	Catalog number	No. of poles	Rated current	Catalog number
1	0.2	S201P-K0.2	3	0.2	S203P-K0.2
	0.3	S201P-K0.3		0.3	S203P-K0.3
	0.5	S201P-K0.5		0.5	S203P-K0.5
	0.75	S201P-K0.75		0.75	S203P-K0.75
	1	S201P-K1		1	S203P-K1
	1.6	S201P-K1.6		1,6	S203P-K1,6
	2	S201P-K2		2	S203P-K2
	3	S201P-K3		3	S203P-K3
	4	S201P-K4		4	S203P-K4
	6	S201P-K6		6	S203P-K6
	8	S201P-K8		8	S203P-K8
	10	S201P-K10		10	S203P-K10
	13	S201P-K13		13	S203P-K13
	16	S201P-K16		16	S203P-K16
	20	S201P-K20		20	S203P-K20
25	S201P-K25	25	S203P-K25		
32	S201P-K32	32	S203P-K32		
40	S201P-K40	40	S203P-K40		
50	S201P-K50	50	S203P-K50		
63	S201P-K63	63	S203P-K63		
2	0.2	S202P-K0.2			
	0.3	S202P-K0.3			
	0.5	S202P-K0.5			
	0.75	S202P-K0.75			
	1	S202P-K1			
	1.6	S202P-K1,6			
	2	S202P-K2			
	3	S202P-K3			
	4	S202P-K4			
	6	S202P-K6			
	8	S202P-K8			
	10	S202P-K10			
	13	S202P-K13			
	16	S202P-K16			
	20	S202P-K20			
25	S202P-K25				
32	S202P-K32				
40	S202P-K40				
50	S202P-K50				
63	S202P-K63				

Tripping characteristic K

UL 1077
480Y/277 VAC
10 kA

Inductive loads

- K Curve
- Designed for allowing higher in-rush currents during system start up
- Example: motors, transformers

Accessories & technical data

Accessories – See page 26

Technical data – See page 76 - 82

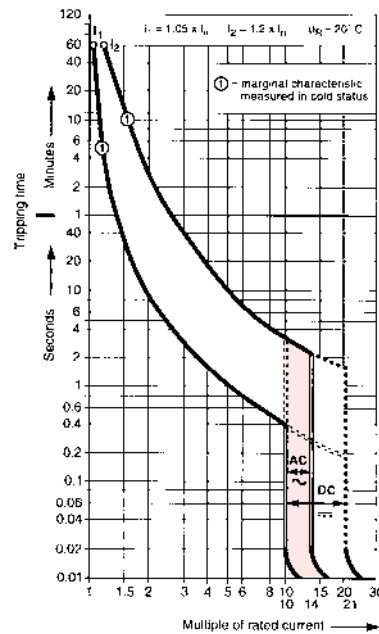

Note: This breaker for AC use only

S200P-Z, 480Y/277 VAC

Supplemental protectors

UL 1077, CSA 22.2

Z



S201P-Z



S202P-Z

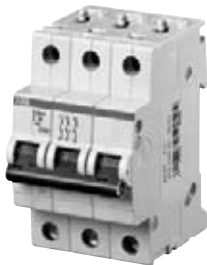

S203P-Z

No. of poles	Rated current	Catalog number	No. of poles	Rated current	Catalog number
1	0.5	S201P-Z0.5	3	0.5	S203P-Z0.5
	1	S201P-Z1		1	S203P-Z1
	1.6	S201P-Z1.6		1.6	S203P-Z1.6
	2	S201P-Z2		2	S203P-Z2
	3	S201P-Z3		3	S203P-Z3
	4	S201P-Z4		4	S203P-Z4
	6	S201P-Z6		6	S203P-Z6
	8	S201P-Z8		8	S203P-Z8
	10	S201P-Z10		10	S203P-Z10
	16	S201P-Z16		16	S203P-Z16
	20	S201P-Z20		20	S203P-Z20
	25	S201P-Z25		25	S203P-Z25
	32	S201P-Z32		32	S203P-Z32
40	S201P-Z40	40	S203P-Z40		
50	S201P-Z50	50	S203P-Z50		
63	S201P-Z63	63	S203P-Z63		
2	0.5	S202P-Z0.5			
	1	S202P-Z1			
	1.6	S202P-Z1.6			
	2	S202P-Z2			
	3	S202P-Z3			
	4	S202P-Z4			
	6	S202P-Z6			
	8	S202P-Z8			
	10	S202P-Z10			
	16	S202P-Z16			
	20	S202P-Z20			
	25	S202P-Z25			
	32	S202P-Z32			
40	S202P-Z40				
50	S202P-Z50				
63	S202P-Z63				

Tripping characteristic Z

UL 1077
480Y/277 VAC
10 kA

Resistive loads

- Z Curve
- Designed to provide maximum protection with a very low short circuit trip setting
- Example: semiconductors

Accessories & technical data

Accessories – See page 26

Technical data – See page 76 - 82

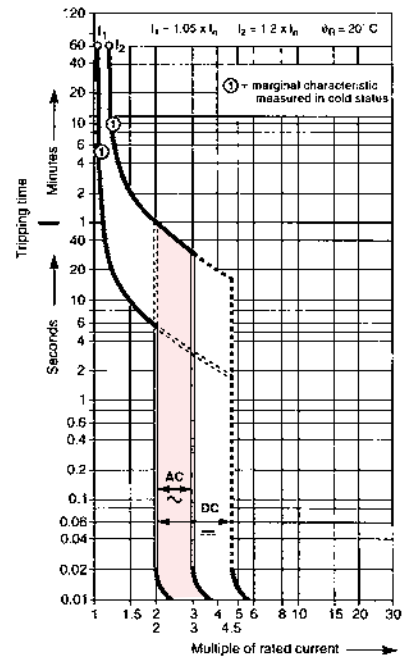

Note: This breaker for AC use only

S280W-K 480Y/277 VAC

Supplemental protectors, ring tongue
UL 1077, CSA 22.2

K



S281-KW



S282-KW



S283-KW

No. of poles	Rated current	Catalog number	No. of poles	Rated current	Catalog number
1	0.2	S281-K0.2W	3	0.2	S283-K0.2W
	0.3	S281-K0.3W		0.3	S283-K0.3W
	0.5	S281-K0.5W		0.5	S283-K0.5W
	0.75	S281-K0.75W		0.75	S283-K0.75W
	1	S281-K1W		1	S283-K1W
	1.6	S281-K1.6W		1,6	S283-K1,6W
	2	S281-K2W		2	S283-K2W
	3	S281-K3W		3	S283-K3W
	4	S281-K4W		4	S283-K4W
	6	S281-K6W		6	S283-K6W
	8	S281-K8W		8	S283-K8W
	10	S281-K10W		10	S283-K10W
	13	S281-K13W		13	S283-K13W
	16	S281-K16W		16	S283-K16W
2	0.2	S282-K0.2W	3	0.2	S283-K0.2W
	0.3	S282-K0.3W		0.3	S283-K0.3W
	0.5	S282-K0.5W		0.5	S283-K0.5W
	0.75	S282-K0.75W		0.75	S283-K0.75W
	1	S282-K1W		1	S283-K1W
	1.6	S282-K1,6W		1,6	S283-K1,6W
	2	S282-K2W		2	S283-K2W
	3	S282-K3W		3	S283-K3W
	4	S282-K4W		4	S283-K4W
	6	S282-K6W		6	S283-K6W
	8	S282-K8W		8	S283-K8W
	10	S282-K10W		10	S283-K10W
	13	S282-K13W		13	S283-K13W
	16	S282-K16W		16	S283-K16W
20	S282-K20W	20	S283-K20W		
25	S282-K25W	25	S283-K25W		
32	S282-K32W	32	S283-K32W		
40	S282-K40W	40	S283-K40W		
50	S282-K50W	50	S283-K50W		
63	S282-K63W	63	S283-K63W		

Tripping characteristic K

Ring tongue
compatible

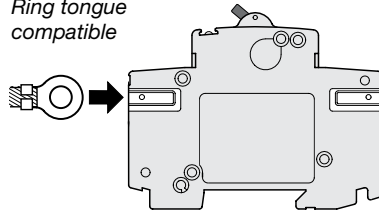

UL 1077
480Y/277 VAC
10 kA

Inductive loads

- K Curve
- Designed for allowing higher in-rush currents during system start up
- Example: motors, transformers

Accessories & technical data

Accessories – See page 26

Technical data – See page 76 - 82

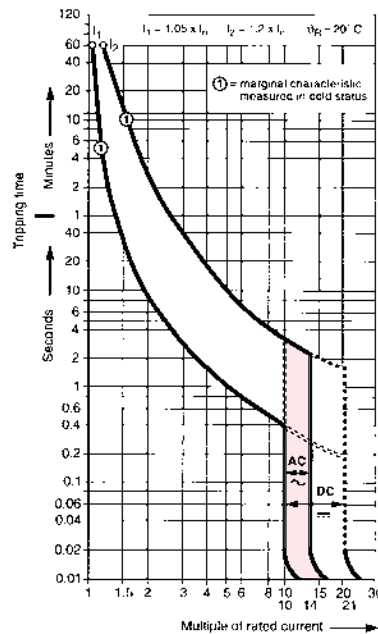

Note: This breaker for AC use only

S280UC-K, 500 VDC

Supplemental protectors

UL 1077, CSA 22.2

Miniature
circuit breakers

K



S281UC-K



S282UC-K



S283UC-K

No. of poles	Rated current	Catalog number	No. of poles	Rated current	Catalog number
1	0,2	S281UC-K0,2	3	0,2	S283UC-K0.2
	0,3	S281UC-K0,3		0,3	S283UC-K0.3
	0,5	S281UC-K0,5		0,5	S283UC-K0.5
	0,75	S281UC-K0,75		0,75	S283UC-K0.75
	1	S281UC-K1		1	S283UC-K1
	1,6	S281UC-K1,6		1,6	S283UC-K1.6
	2	S281UC-K2		2	S283UC-K2
	3	S281UC-K3		3	S283UC-K3
	4	S281UC-K4		4	S283UC-K4
	6	S281UC-K6		6	S283UC-K6
	8	S281UC-K8		8	S283UC-K8
	10	S281UC-K10		10	S283UC-K10
	16	S281UC-K16		16	S283UC-K16
	20	S281UC-K20		20	S283UC-K20
2	0,2	S282UC-K0,2	3	0,2	S283UC-K0.2
	0,3	S282UC-K0,3		0,3	S283UC-K0.3
	0,5	S282UC-K0,5		0,5	S283UC-K0.5
	0,75	S282UC-K0,75		0,75	S283UC-K0.75
	1	S282UC-K1		1	S283UC-K1
	1,6	S282UC-K1,6		1,6	S283UC-K1.6
	2	S282UC-K2		2	S283UC-K2
	3	S282UC-K3		3	S283UC-K3
	4	S282UC-K4		4	S283UC-K4
	6	S282UC-K6		6	S283UC-K6
	8	S282UC-K8		8	S283UC-K8
	10	S282UC-K10		10	S283UC-K10
	16	S282UC-K16		16	S283UC-K16
	20	S282UC-K20		20	S283UC-K20
25	S282UC-K25	25	S283UC-K25		
32	S282UC-K32	32	S283UC-K32		
40	S282UC-K40	40	S283UC-K40		
50	S282UC-K50	50	S283UC-K50		
63	S282UC-K63	63	S283UC-K63		

Tripping characteristic K

UL 1077
500 VDC
10 kA

Inductive loads

- K Curve
- Designed for allowing higher in-rush currents during system start up
- Example: motors, transformer

Accessories & technical data

Accessories – See page 26

Technical data – See page 76 - 82

Direct current applications

The S280UC differs from standard miniature circuit breakers in that the UC versions include a permanent magnet which aids in the extinguishing of the arc during medium and high level faults. It is necessary to observe the correct polarity and current direction when connecting the UC breakers. Two examples of correct connection are shown.

Termination points are marked on all UC type MCBs, points one (1) and four (4) are negative and points two (2) and three (3) are positive.

Note: This breaker for DC use only

250 V DC

Single Pole
S201DC

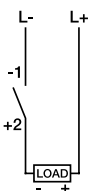

500 VDC

Two Pole
S282UC

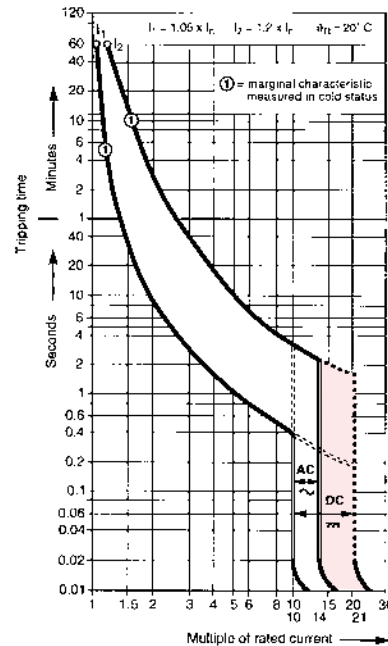
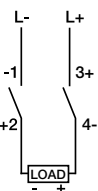

S280UC-Z, 500 VDC

Supplemental protectors

UL 1077, CSA 22.2

Z



S281UC-Z



S282UC-Z



S283UC-Z

No. of poles	Rated current	Catalog number	No. of poles	Rated current	Catalog number
1	0.5	S281UC-Z0.5	3	0.5	S283UC-Z0.5
	1	S281UC-Z1		1	S283UC-Z1
	1.6	S281UC-Z1.6		1.6	S283UC-Z1.6
	2	S281UC-Z2		2	S283UC-Z2
	3	S281UC-Z3		3	S283UC-Z3
	4	S281UC-Z4		4	S283UC-Z4
	6	S281UC-Z6		6	S283UC-Z6
	8	S281UC-Z8		8	S283UC-Z8
	10	S281UC-Z10		10	S283UC-Z10
	16	S281UC-Z16		16	S283UC-Z16
	20	S281UC-Z20		20	S283UC-Z20
	25	S281UC-Z25		25	S283UC-Z25
	32	S281UC-Z32		32	S283UC-Z32
	40	S281UC-Z40		40	S283UC-Z40
50	S281UC-Z50	50	S283UC-Z50		
63	S281UC-Z63	63	S283UC-Z63		
2	0.5	S282UC-Z0.5	3	0.5	S283UC-Z0.5
	1	S282UC-Z1		1	S283UC-Z1
	1.6	S282UC-Z1.6		1.6	S283UC-Z1.6
	2	S282UC-Z2		2	S283UC-Z2
	3	S282UC-Z3		3	S283UC-Z3
	4	S282UC-Z4		4	S283UC-Z4
	6	S282UC-Z6		6	S283UC-Z6
	8	S282UC-Z8		8	S283UC-Z8
	10	S282UC-Z10		10	S283UC-Z10
	16	S282UC-Z16		16	S283UC-Z16
	20	S282UC-Z20		20	S283UC-Z20
	25	S282UC-Z25		25	S283UC-Z25
	32	S282UC-Z32		32	S283UC-Z32
	40	S282UC-Z40		40	S283UC-Z40
50	S282UC-Z50	50	S283UC-Z50		
63	S282UC-Z63	63	S283UC-Z63		

Tripping characteristic Z

UL 1077
500 VDC
10 kA

Resistive loads

- Z Curve
- Designed to provide maximum protection with a very low short circuit trip setting
- Example: semiconductors

Accessories & technical data

Accessories – See page 26
Technical data – See page 76 - 82

Direct current applications

The S280UC differs from standard miniature circuit breakers in that the UC versions include a permanent magnet which aids in the extinguishing of the arc during medium and high level faults. It is necessary to observe the correct polarity and current direction when connecting the UC breakers. Two examples of correct connection are shown.

Termination points are marked on all UC type MCBs, points one (1) and four (4) are negative and points two (2) and three (3) are positive.

Note: This breaker for DC use only

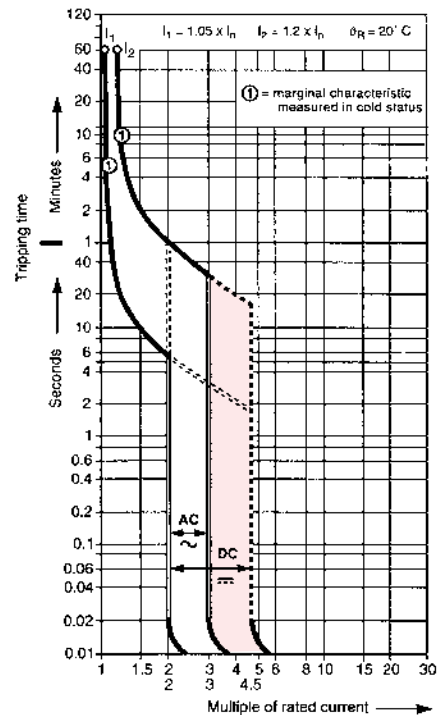

250 V DC

Single Pole
S201DC

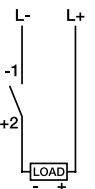

500 VDC

Two Pole
S282UC

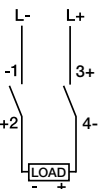

S290
480Y/277 VAC
UL 1077, CSA 22.2

C



S291-C

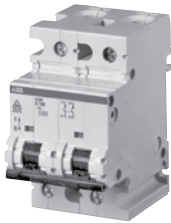

S292-C

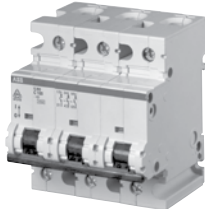

S293-C

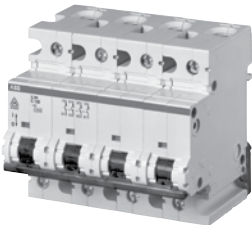

S294-C

No. of poles	Rated current	Catalog number
1	80	S291-C80
	100	S291-C100
	125	S291-C125
2	80	S292-C80
	100	S292-C100
	125	S292-C125
3	80	S293-C80
	100	S293-C100
	125	S293-C125
4	80	S294-C80
	100	S294-C100
	125	S294-C125

Tripping characteristic C

UL 1077

480Y/277 VAC

6 kA

Resistive loads

- C Curve
- Designed for use with medium magnetic start up currents
- Example: lighting, control panels

Accessories & technical data

Accessories – See page 27

Technical data – See page 76 - 82

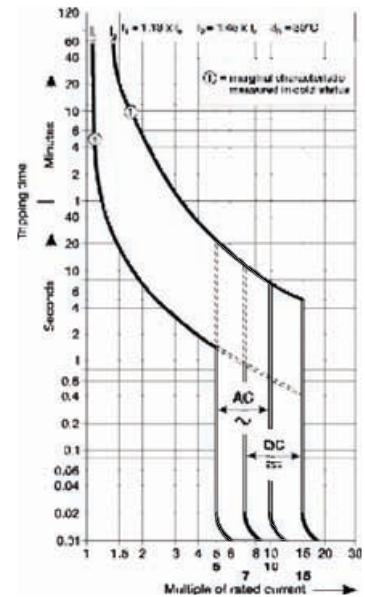

Note: This breaker for AC use only

Accessories

S200, S200P, S280UC & S280W

UL 1077, CSA 22.2



S2C-H6R



S2C-A



S2C-UA

Auxiliary contacts

The auxiliary contacts will signal whether the breaker is in the ON or OFF position.

Description	Catalog number
For field mounting: right side	S2C-H6R

Bell alarm

The bell alarm includes a set of contacts that will only signal when the breaker has tripped. Typically the contacts would be connected to an alarm or bell to signal the operator that an overcurrent trip has occurred. The bell alarm also includes a test button for testing the alarm contacts without opening the breaker.

Description	Catalog number
For field mounting: right side	S2C-S/H6R ①

Shunt trip

For remote tripping of breaker, a shunt trip device can be added to the MCB. The solenoid device opens the breaker after control voltage is applied.

Description	Catalog number
For field mounting: right side	
A1-12-60 VAC (12 – 60 VDC)	S2C-A1
A2-110-415 VAC (110 – 250 VDC)	S2C-A2

Undervoltage release

When control voltage drops below approximately 50 % of rated voltage, the UVR opens the breaker. The breaker can not be operated unless proper control voltage is first applied to the UVR coil.

Description	Catalog number
For field mounting: right side	
12 VDC	S2C-UA 12
24 VAC/VDC	S2C-UA 24
48 VAC/VDC	S2C-UA 48
110 VAC/VDC	S2C-UA 110
220 VAC/VDC	S2C-UA 230
380 VAC	S2C-UA 400

Possible mounting arrangements of MCB accessories

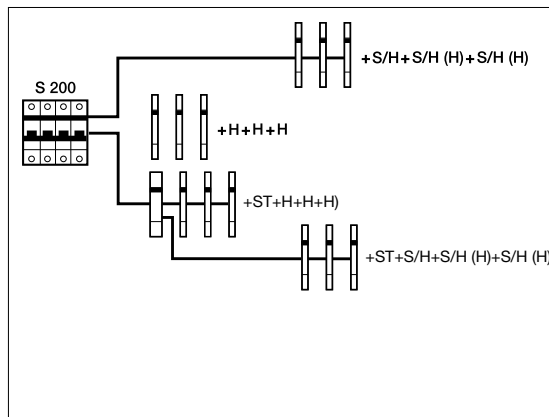

Legend	
Auxiliary contact	H
Bell alarm/Auxiliary contact	S/H
Bell alarm/Auxiliary contact used as auxiliary contact	S/H (H)
Shunt trip	ST
Undervoltage release	UR

① Combination bell alarm/auxiliary contact.

Accessories

S290

UL 1077, CSA 22.2

Miniature
circuit breakers



S290-H11

Auxiliary contacts

The auxiliary contacts will signal whether the breaker is in the ON or OFF position.

Description	Catalog number
Auxiliary contact	S290-H11

Bell alarm

The bell alarm includes a set of contacts that will only signal when the breaker has tripped.

Typically the contacts would be connected to an alarm or bell to signal the operator that an overcurrent trip has occurred. The bell alarm also includes a test button for testing the alarm contacts without opening the breaker.

Description	Catalog number
Signal contact	S290-S

Shunt trip

For remote tripping of breaker, a shunt trip device can be added to the MCB. The solenoid device opens the breaker after control voltage is applied.

Description	Catalog number
For field mounting, left side	
110V – 415VAC	S290-A1
For field mounting, left side	
24 – 48VDC	S290-A2

Approximate dimensions

S200, S200P, S280UC, S280W, S290
UL 1077, CSA 22.2

S200, S200P

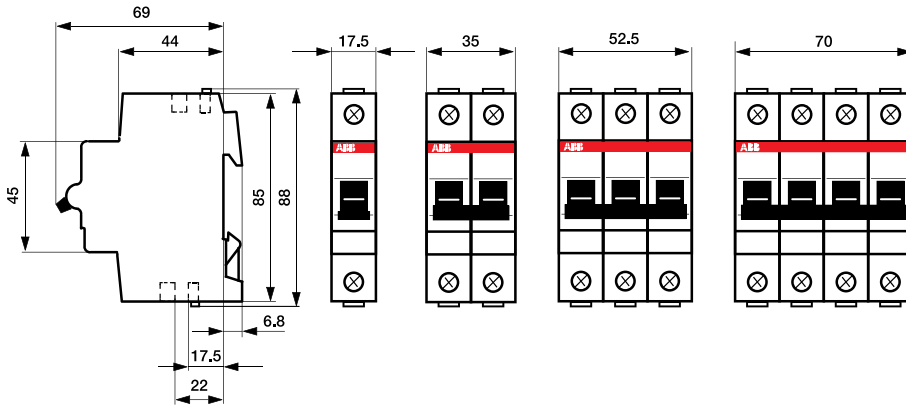

S280UC & S280W

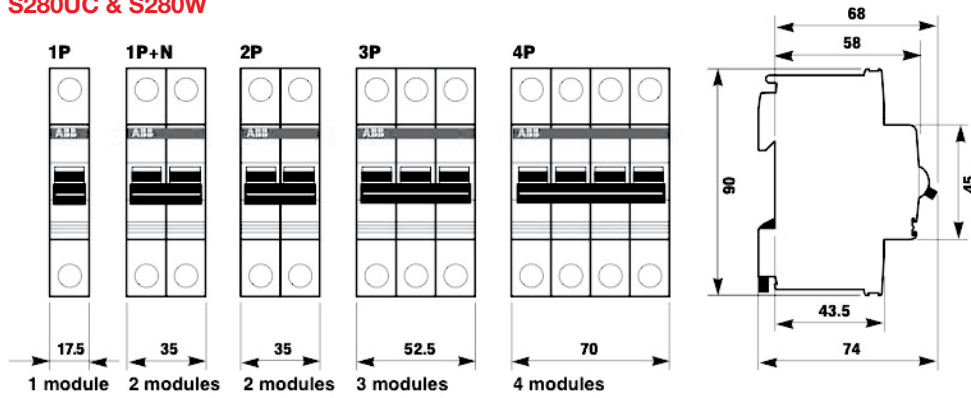

S290

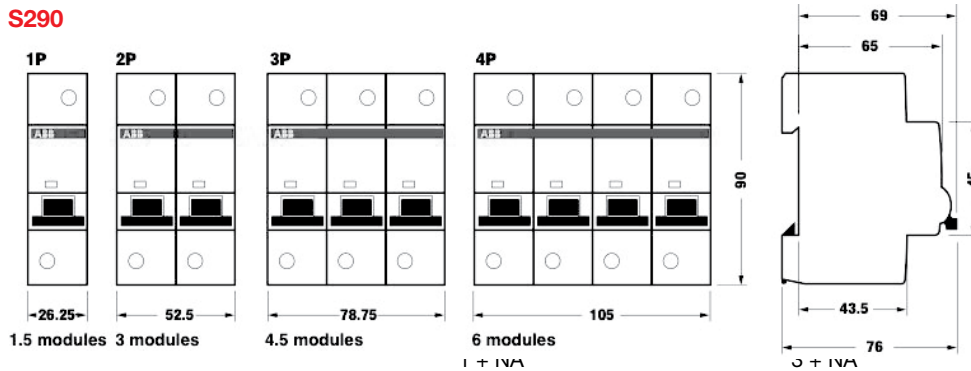

S2C-H6R, S2C-A... S2C

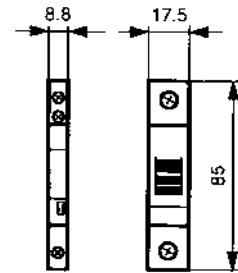

Addition of S2C-A...U

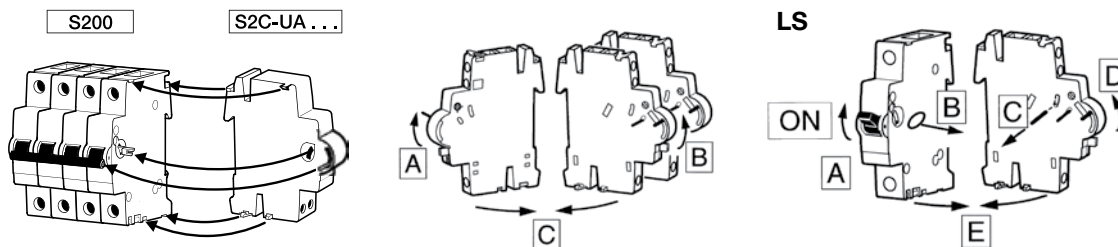

Accessories

S200, S200P, S280UC, S280W

UL 1077, CSA 22.2

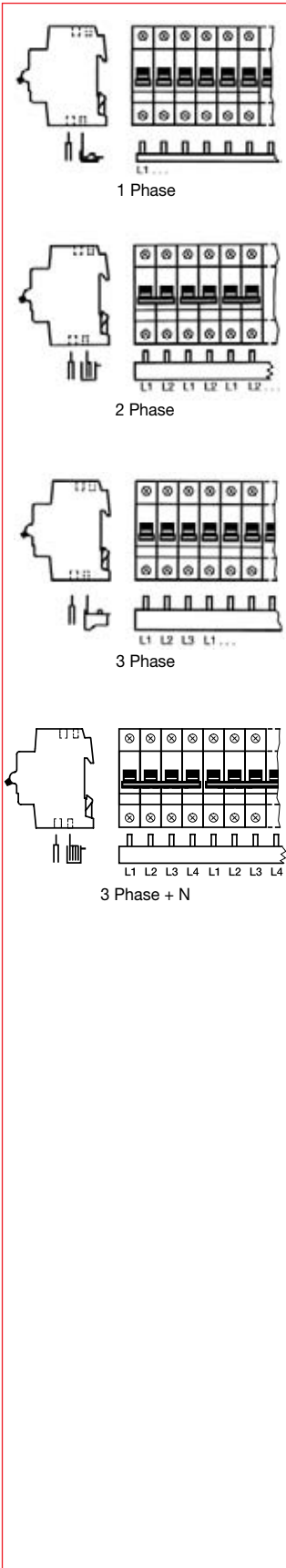

1 Phase

For use on:	Amp rating	Number of poles	Phases	Busbar length (mm)	End cap catalog number	Catalog number
S200						
S200 P	63	60	1	986	-	PS1/60
S280UC	80	60	1	986	-	PS1/60/16
S280W						

2 Phase

For use on:	Amp rating	Number of poles	Phases	Busbar length (mm)	End cap catalog number	Catalog number
S200						
S200 P	63	58	2	1035	PS-END	PS2/58SP
S280UC	80	58	2	1035	PS-END	PS2/58/16SP
S280W						

3 Phase

For use on:	Amp rating	Number of poles	Phases	Busbar length (mm)	End cap catalog number	Catalog number
S200						
S200 P	63	60	3	1065	PSB-ENDSP	PS3/60SP
S280UC	80	60	3	1065	PSB-ENDSP	PS3/60/16SP
S280W						

4 Phase

For use on:	Amp rating	Number of poles	Phases	Busbar length (mm)	End cap catalog number	Catalog number
S200						
S200 P	80	60	4	1056	PS-END1	PS4/60/16SP
S280UC	80	60	4	1056	PS-END1	PS4/60/16SP
S280W						

NOTE

All busbars may be center fed in order to double the ampacity rating

NOTE

Busbars may be used on line or load side of MCBs

Accessories

S200, S200P, S280UC, S280W

UL 1077, CSA 22.2

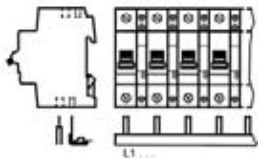

1 Phase + Aux

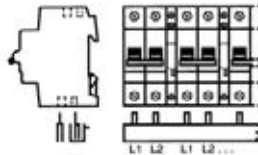

2 Phase + Aux

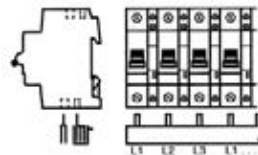

3 Phase + Aux

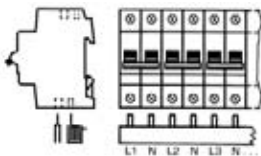

3 Phase + N

1 Phase with 1 auxiliary

For use on:	Amp rating	Number of poles	Phases	Busbar length (mm)	End cap catalog number	Catalog number
S200 & S200 P	63	38	1	1044	–	PS1/38H
S200 & S200 P	80	38	1	1044	–	PS1/38/16H

2 Phase with 1 auxiliary

For use on:	Amp rating	Number of poles	Phases	Busbar length (mm)	End cap catalog number	Catalog number
S200 & S200 P	80	48	2	1065	PS-ENDSP	PS2/48/16SP

3 Phase with 1 auxiliary

For use on:	Amp rating	Number of poles	Phases	Busbar length (mm)	End cap catalog number	Catalog number
S200 & S200 P	80	39	3	980	PS-ENDSP	PS2/39/16SP

3 Phase + N, for use with 2 pole-MCBs on 3 phase/4W system

For use on:	Amp rating	Number of poles	Phases	Busbar length (mm)	End cap catalog number	Catalog number
S200 & S200 P	80	58	4	1048	PS-END1SP	PS4/58/16NSP

NOTE

All busbars may be center fed in order to double the ampacity rating

NOTE

Busbars may be used on line or load side of MCBs

Accessories

S200, S200P, S280W, S280UC
UL 1077, CSA 22.2



SZ-BSK



SZ-ESK2

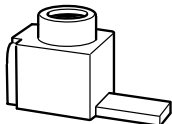

SZ-AST55I

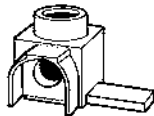

SZ-AST50I

Busbar tooth covers

Description	Catalog number
Covers five unused poles of busbar	SZ-BSK

Busbar mounted terminal block

Description	Catalog number
Busbar mounted terminal block, 1 pole, for use on all busbars, Wire size: 14 AWG to 2 AWG	SZ-ESK2

Connection terminals

Description		For use on:	Catalog number
Cross section	AWG/mm ²		
AWG 1/0 (50 mm ²)	Straight	S200 & S200P	SZ-AST55I
AWG 1/0 (50 mm ²)	90°		SZ-AST50I

Technical data

S200, S200P, S280UC, S280W, S290 UL 1077, CSA 22.2

Technical data	S200	S200P	S290
Specifications:	UL 1077, CSA C 22.2, VDE 0660, IEC 898, 947		UL 1077, IEC 898
UL File-Number:	E 76126 UL CL		
No. of poles:	1, 2, 3 & 4		1, 2, 3 & 4
Tripping characteristics:	B, C & D	K & Z	C
Rated current:	0.5-63 A	0.2-63 A	80-125A
Rated voltage:	Multi pole: 480Y/277 VAC		230Y/440VAC
Short circuit capacity:	S200 6kA; S200P 10 kA		—
Frequency:	50/60 Hz		50/60 Hz
Degree of protection:	IP 20		IP 20
Mounting position:	Vertical, horizontal		Vertical, horizontal
Fixing:	35mm DIN rail		35mm DIN rail
Clamps only for Cu:	18 ... 4 AWG		14-1/0 AWG
Service life, mech. and at rated load:	20,000 operations		10,000
Tightening torque:	17.5 in. lbs (1.978 Nm)		4.5 in. lbs
Ambient temperature:	- 25°C ... - 13°F / 70°C ... 158°F		-5°C... 23°F / 45°C... 113
Shock resistance:	10 g at least 2 impacts shock duration of 13 ms		30g min. of 2 impacts, shock duration of 13 ms

Auxiliary contact S2C-H6RU and Signal contact S2C-S6RU for S200U and S200UP

Rated current:	10
Rated voltage AC / DC:	24
Contact:	1 pole, single throw
Connection capacity mm ²	18 – 14 AWG (0.75...2.5)
Tightening torque:	11 in. lbs (1.2 Nm)
Shock resistance acc. to DIN IEC 68-2-6:	5 g, 20 frequency cycles 5...150...5 Hz at 24 VAC/DC, 5 mA auto-reclosing < 10 ms
Mechanical service life:	10,000 operations

Shunt trip

		S2C-A1U	S2C-A2U
Rated voltage	AC	12 ... 60 V	110 ... 415 V
	DC	12 ... 60 V	110 ... 250 V
Max. release duration		< 10 ms	< 10 ms
Min. release voltage	AC	7 V	55 V
	DC	10 V	80 V
Consumption on release	AD	40 ... 200 VA	55 ... 210 VA
	DC	40 ... 200 VA	55 ... 110 VA
Coil resistance		3.7 Ω	225 Ω
Terminals		18...6/0.75 – 16 AWG/mm ²	18...6/0.75 – 16 AWG/mm ²
Tightening torque		18/2 in.lbs/Nm	18/2 in.lbs/Nm

Undervoltage release

		S2C-UA 12 DC	S2C-UA 24 AC	S2C-UA 24 DC	S2C-UA 48 AC	S2C-UA 48 DC	S2C-UA 110 AC	S2C-UA 110 DC	S2C-UA 230 AC	S2C-UA 230 DC	S2C-UA 400 AC
Standards		IEC/EN 60947-1									
Rated voltage	AC	12 V	24 V	24 V	48 V	48 V	110 V	110 V	230 V	230 V	400 V
	DC										
Frequency		50 ... 60 Hz									
Release trip		0.35 UnOVO 0.7 Un V									
Terminals		2 x 16/2 x 1.5 AWG/mm ²									
Consumption		0.2 VA	3.6 VA	2 VA	3.6 VA	2.1 VA	3.5 VA	2.2 VA	3.7 VA	2.3 VA	2.4 VA
Resistance to corrosion		constant atmosphere: 23/83 – 40/93 – 55/20; variable atmosphere: 25/95 – 40/93 °C/RH									
Protection degree		IPXXB/IP2X									
Tightening torque		3.5/0.4 in.lbs/Nm									

Technical data

S200 & S200P

UL 1077, CSA 22.2

Miniature
circuit breakers

Internal resistance and power loss

Internal resistance per pole in mΩ, power loss per pole in W

Type	Rated current	Device series B, C, D ^①		Device series K		Device series Z	
		mΩ	W	mΩ	W	mΩ	W
S200 & S200P	0.5	5500	1.4	6340	1.6	10100	2.5
	1	1440	1.4	1550	1.6	2270	2.3
	1.6	630	1.6	695	1.8	1100	2.8
	2	460	1.8	460	1.9	619	2.5
	3	150	1.3	165	1.5	202	1.8
	4	110	1.8	120	2.0	149	2.4
	6	55	2.0	52	1.9	104	3.7
	8	15	1.0	38	2.5	53.9	3.45
	10	13.3	1.3	12.6	1.26	17.5	1.7
	13	13.3	2.3	12.6	1.26	-	-
	16	7.0	1.8	7.7	2.0	10.9	2.8
	20	6.25	2.5	6.7	2.7	6.0	2.4
	25	5.0	3.2	4.6	2.9	4.1	2.6
	32	3.6	3.7	3.5	3.6	2.8	2.9
40	3.0	4.8	2.8	4.5	2.5	4.1	
50	1.3	3.25	1.25	2.9	1.8	4.4	
63	1.2	4.8	0.7	5.2	1.3	5.2	

① Current intensities 0.5 - 4 apply exclusively to C-type trip characteristics

Temperature derating

Max operating current depending on the ambient temperature of a circuit breaker characteristics type B, C and D

B,C & D	Ambient Temperatures T (C°/F°)											
	-40/-40	-30/-22	-20/-4	-10/14	0/32	10/50	20/68	30/86	40/104	50/122	60/140	70/158
Amps	0.67	0.65	0.62	0.60	0.58	0.55	0.53	0.50	0.47	0.44	0.41	0.37
	1.33	1.29	1.25	1.20	1.15	1.11	1.05	1.00	0.94	0.88	0.82	0.75
	2.13	2.07	2.00	1.92	1.85	1.77	1.69	1.60	1.51	1.41	1.31	1.19
	2.67	2.58	2.49	2.40	2.31	2.21	2.11	2.00	1.89	1.76	1.63	1.49
	4.0	3.9	3.7	3.6	3.5	3.3	3.2	3.0	2.8	2.6	2.4	2.2
	5.3	5.2	5.0	4.8	4.6	4.4	4.2	4.0	3.8	3.5	3.3	3.0
	8.0	7.7	7.5	7.2	6.9	6.6	6.3	6.0	5.7	5.3	4.9	4.5
	10.7	10.3	10.0	9.6	9.2	8.8	8.4	8.0	7.5	7.1	6.5	6.0
	13.3	12.9	12.5	12.0	11.5	11.1	10.5	10.0	9.4	8.8	8.2	7.5
	17.3	16.8	16.2	15.6	15.0	14.4	13.7	13.0	12.3	11.5	10.6	9.7
	21.3	20.7	20.0	19.2	18.5	17.7	16.9	16.0	15.1	14.1	13.1	11.9
	26.7	25.8	24.9	24.0	23.1	22.1	21.1	20.0	18.9	17.6	16.3	14.9
	33.3	32.3	31.2	30.0	28.9	27.6	26.4	25.0	23.6	22.0	20.4	18.6
	42.7	41.3	39.9	38.5	37.0	35.4	33.7	32.0	30.2	28.2	26.1	23.9
	53.3	51.6	49.9	48.1	46.2	44.2	42.2	40.0	37.7	35.3	32.7	29.8
	66.7	64.5	62.4	60.1	57.7	55.3	52.7	50.0	47.1	44.1	40.8	37.3
	84.0	81.3	78.6	75.7	72.7	69.6	66.4	63.0	59.4	55.6	51.4	47.0
	112.6	107.2	102.1	97.2	92.6	88.2	84.0	80.0	76.0	72.2	68.6	65.2
	140.7	134.0	127.6	121.6	115.8	110.3	105.0	100.0	95.0	90.3	85.7	81.5
	175.9	167.5	159.5	151.9	144.7	137.8	131.3	125.0	118.8	112.8	107.2	101.8

Technical data

S200, S200P, S280UC, S280W, S290
UL 1077, CSA 22.2

Tripping characteristic B

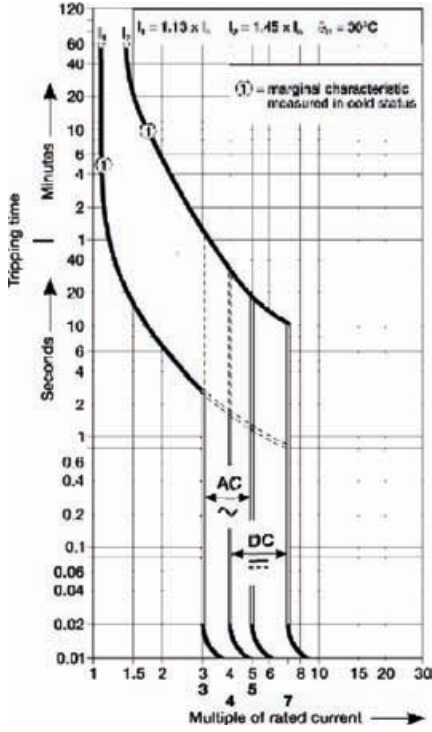

Tripping characteristic C

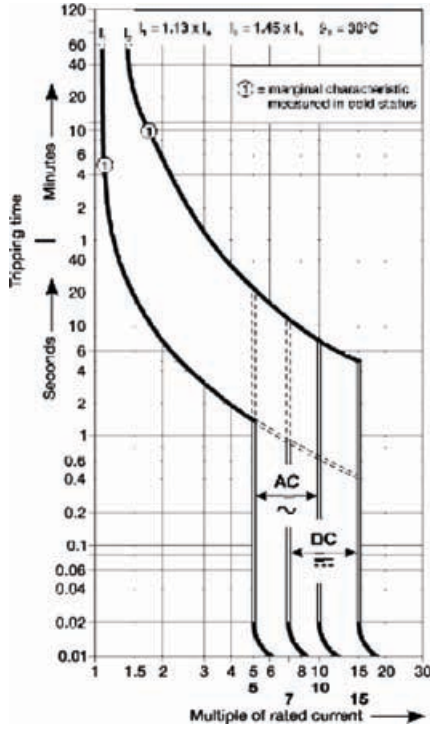

Tripping characteristic D

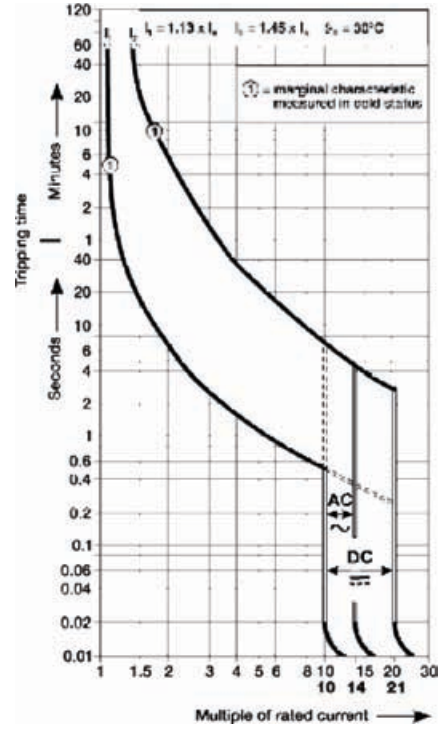

Tripping characteristic K

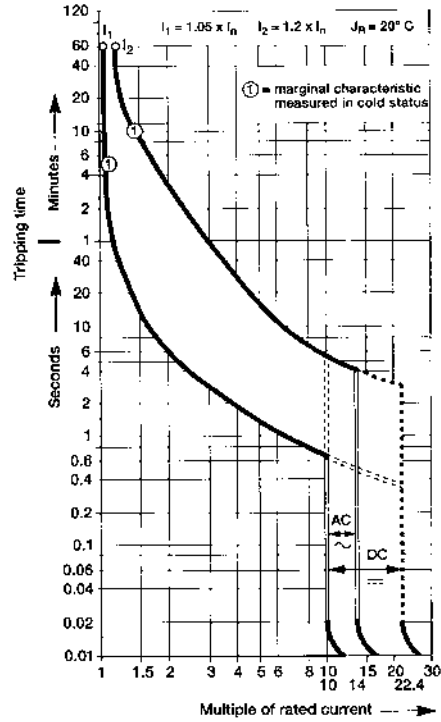

Tripping characteristic Z

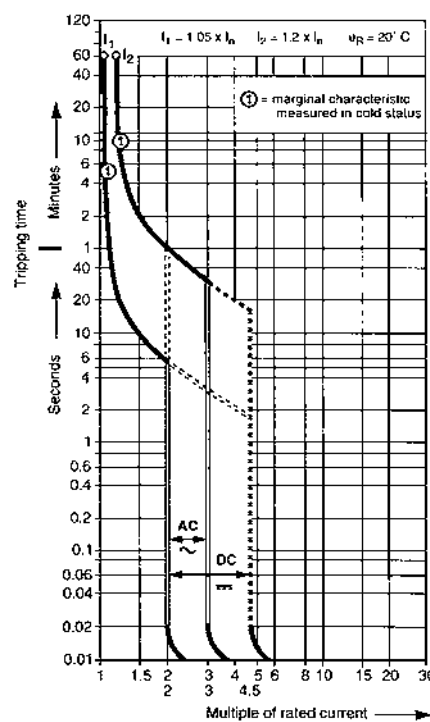

Introduction

The circuit breaker plays an important role in providing over-current protection and a disconnect means in electrical networks. Recent advancements in circuit breaker technology has increased breaker performance and protection.

Overload

A slow and small overcurrent situation that causes the ampacity and temperature of the circuit to gradually increase over time. This type of event is characterized by a slight increase in the load (ampacity) on the circuit and is interrupted by the thermal trip unit of the breaker.

Thermal Example

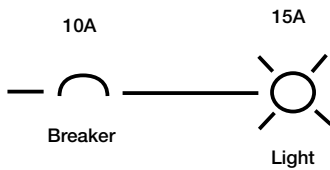

The light draws more than 10 amps for an extended period of time creating a thermal overload.

Short circuit

A rapid and intense overcurrent situation that causes the ampacity of the circuit to increase. This type of event is characterized by a dramatic increase in the load (ampacity) on the circuit and is interrupted by the magnetic trip unit of the breaker.

Magnetic Example

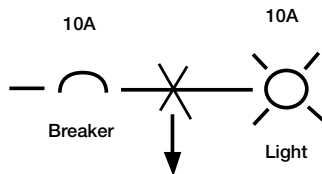

The wire connected between the light and breaker is cut and shorted to ground creating a short circuit.

Breaker definition

A breaker is a device designed to isolate a circuit during an overcurrent event without the use of a fusible element. A breaker is a resettable protective device that protects against two types of overcurrent situations; Overload and Short Circuit.

ABB current limiting breaker

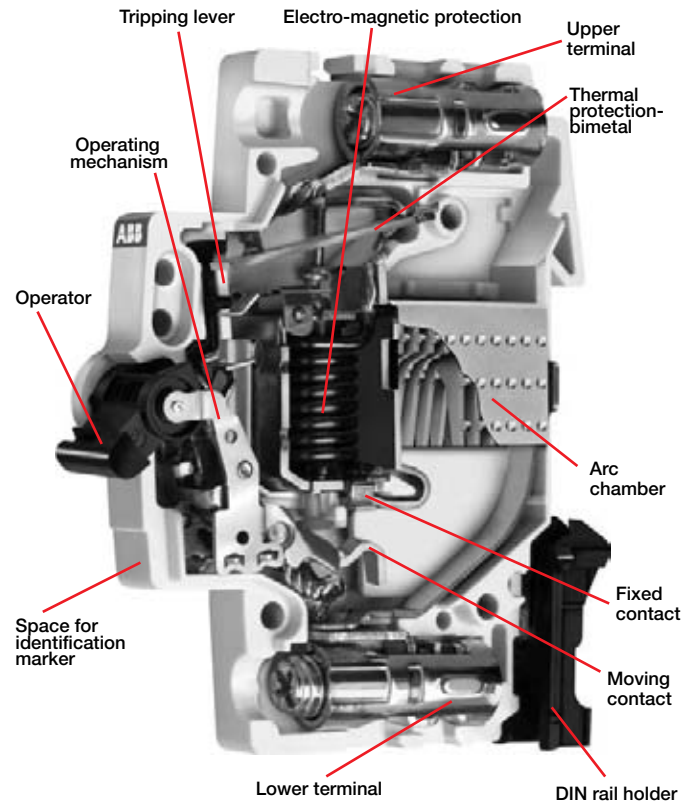

Thermal / Magnetic trip units definition

ABB Current Limiting Breakers use an electromechanical (Thermal / Magnetic) trip unit to open the breaker contacts during an overcurrent event. The thermal trip unit is temperature sensitive and the magnetic trip unit is current sensitive. Both units act independently and mechanically with the breaker's trip mechanism to open the breaker's contacts.

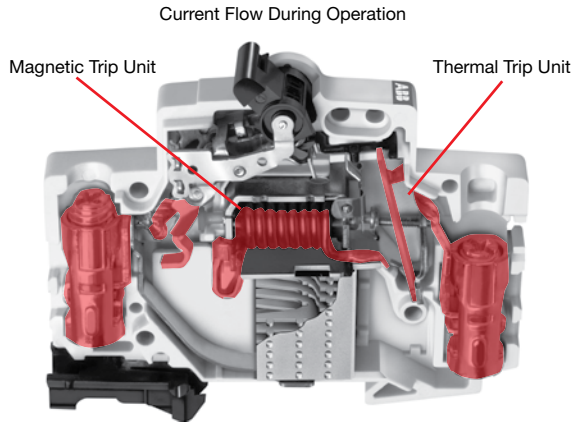

All highlighted components are energized during operation

Overload protection

The thermal trip unit protects against a continuous overload. The thermal unit is comprised of a bimetal element located behind the circuit breaker trip bar and is part of the breaker's current carrying path. When there is an overload, the increased current flow heats the bimetal causing it to bend. As the bimetal bends it pulls the trip bar which opens the breaker's contacts.

The time required for the bimetal to bend and trip the breaker varies inversely with the current. Because of this, the tripping time becomes quicker as current increases in magnitude.

Overload protection is applicable to any installation, conductor, or component which can be subjected to low-magnitude but long-time over-currents. Low-magnitude, long-time over-currents can be dangerous because they reduce the life of the electrical installation, conductor, and components and if left unchecked could result in fire.

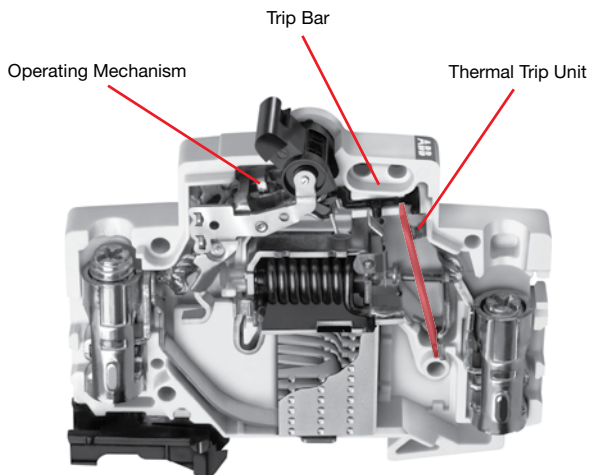

Magnetic trip units (short circuit protection)

The Magnetic trip unit protects against a short circuit. The magnetic trip unit is comprised of an electromagnet and an armature.

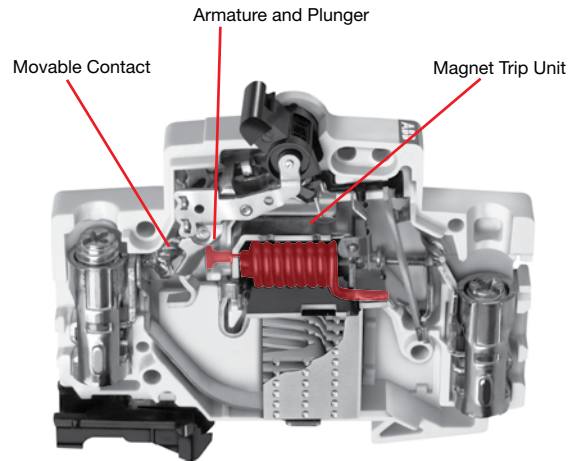

Components of a magnetic trip unit

When there is a short circuit, a high magnitude of current passes through the coils creating a magnetic field that attracts the movable armature towards the fixed armature. The hammer trip is pushed against the movable contact and the contacts are opened. The opening of the breaker's contacts during a short circuit is complete in .5 milli-seconds.

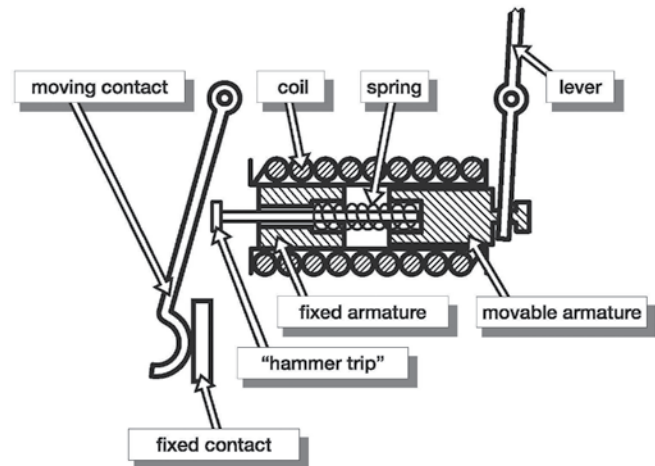

Arc runners / Arc chutes

The arc runner and arc chute limit and dissipate the arc energy during the interruption of an overload or short circuit event.

During an overload or short circuit event, the contacts of the breaker separate and an electrical arc is formed between the contacts through air. The arc is moved into the arc chute by “running” the arc down the interior of the breaker along the arc runner. When the arc reaches the arc chute it is broken into small segmented arcs. The segmented arcs split the overall energy level into segments less than 25V. Each 25V segment does not have a high enough energy level to maintain an arc and all energy is naturally dissipated.

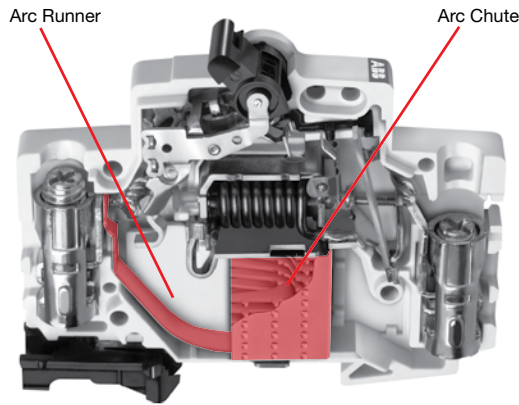

Breaker curves

Thermal Trip Unit (region one)

The first sloping region of the breaker curve is a graphical representation of the tripping characteristics of the thermal trip unit. This portion of the curve is sloped due to the nature of the thermal trip unit. The trip unit bends to trip the breaker's trip bar in conjunction with a rise in amperage (temperature) over time. As the current on the circuit increases, the temperature rises, the faster the thermal element will trip.

Example using the curve below: If you had a 10A breaker and the circuit was producing 30 amps of current, the breaker would trip between 2 seconds and 1 minute. In this example you would find the circuit current on the bottom of the graph (Multiples of rated current). The first line is 10 amps (10 amp breaker x a multiple of one), the second line is 20 amps (10 amp breaker x multiple of 2), and the third line is 30 amps (10 amp breaker x multiple of 3). Next you would trace the vertical 30A line up until it intersects the red portion of the breaker thermal curve. If you follow the horizontal lines, on both sides of the red curve, to the left you will see that the breaker can trip as fast as 2 seconds and no slower than 1 minute.

Magnetic Trip Unit (region two)

This region of the breaker curve is the instantaneous trip unit. ABB's miniature circuit breaker's instantaneous trip unit interrupts a short circuit in 2.3 to 2.5 milliseconds. Because of this the curve has no slope and is graphically represented as a vertical straight line.

Example using the curve above: If you had a 10 amp breaker the magnetic trip element would interrupt a short circuit between 10 and 30 amps (10 amp breaker x multiple of 2 and 3) in 2.3 to 2.5 milliseconds.

Breaker Contacts (region three)

This region of the curve is the time required for the contacts of the breaker to begin to separate. The contacts will open in less than .5 milliseconds and is graphically represented by the bottom vertical portion of the curve.

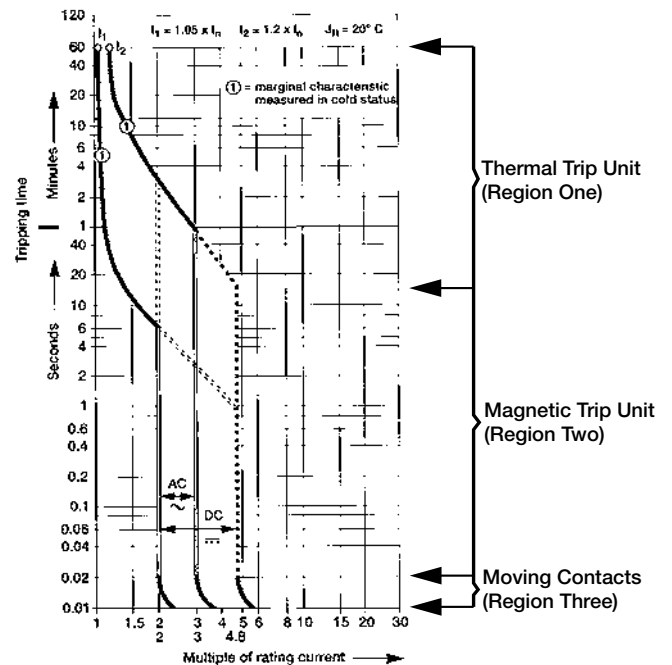

Current limiting definitions

All ABB Miniature Circuit Breakers are UL tested and certified as current limiting protective devices. Current limiting circuit breakers provide a higher level of circuit protection than a typical zero point external breakers.

UL AC 60Hz cycle

UL defines an AC cycle as the potential energy of the wave form traveling from Zero-to-Positive amplitude, Positive-to-Zero amplitude, Zero-to-Negative amplitude, Negative-to-Zero amplitude 60 times in one second. One cycle is completed every 16.6 milliseconds.

UL breaker current limiting

UL defines breaker current limitation as a breaker that interrupts and isolates a fault in less than 1/2 of an AC cycle. 1/2 a cycle is completed in 8.3 milliseconds.

NEC240.2 current limiting

A device that, when interrupting current in its current-limiting range, reduces the current flowing in the faulted circuit to a magnitude substantially less than that obtainable in the same circuit if the device were replaced with a solid conductor having comparable impedance.

IEC 60947-2 current limiting circuit breaker

A circuit breaker with sufficiently short trip time to prevent the short-circuit current from reaching the peak value which would otherwise be reached.

ABB current limiting breakers

ABB current limiting breakers can interrupt and isolate a fault in 1/8 of an AC cycle. The breaker fault interruption is completed in 2.3 to 2.5 milliseconds.

Zero point extinguishing breakers

A typical zero point extinguishing breaker interrupts a fault and does not isolate the energy. The breaker allows an arc to be present between the open contacts until the AC wave form crosses zero. When the wave form crosses zero, the potential energy is zero and the arc (fault) naturally extinguishes. The arc could be present for up to 8.3 milliseconds.

Current limiting breakers and electrical networks

Current Limitation

When a short-circuit condition occurs, the “ideal” current limiting circuit breaker opens before the current waveform can reach its full potential magnitude which occurs at 1/4 cycle (4.17ms). ABB’s current limiting breakers can interrupt a fault in about 1/2 cycle or 2.3ms to 2.5ms.

ABB’s current limiting breakers interrupt a short circuit in less than 1/8 cycle and limit the amount of current that can reach a circuit. Limiting the available current on the circuit provides additional protection against network, breaker, or bus damage and prevents the tripping of upstream breakers (selective coordination).

IsqT

The true destructive nature of a short circuit is measured by the time it is available combined with the peak value of the short circuit. The IsqT (Amps Squared over Time) value represents the amount of energy available on a network during a short circuit and is represented by the shaded area on the graph below.

During a short circuit both magnetic forces and thermal energy combine to damage devices on the electrical network. The level of thermal energy and magnetic forces are directly proportional to the square of the current. The magnetic forces vary as a square of the peak current available and the thermal energy varies as a square of the RMS (root mean square) current available. ABB’s current limiting breakers will limit the let-through energy to a fraction (1/100th) of the value which is available from the network. By comparison, a Zero Crossing breaker would let-through approximately 100 times as much destructive energy as the current limiting circuit breaker [(100,000A / 10,000A) squared – 100X].

ABB’s current limiting breakers limit the short circuit current to a relatively small magnitude in an extremely short time, which dramatically limits a short circuit’s destructive energy.

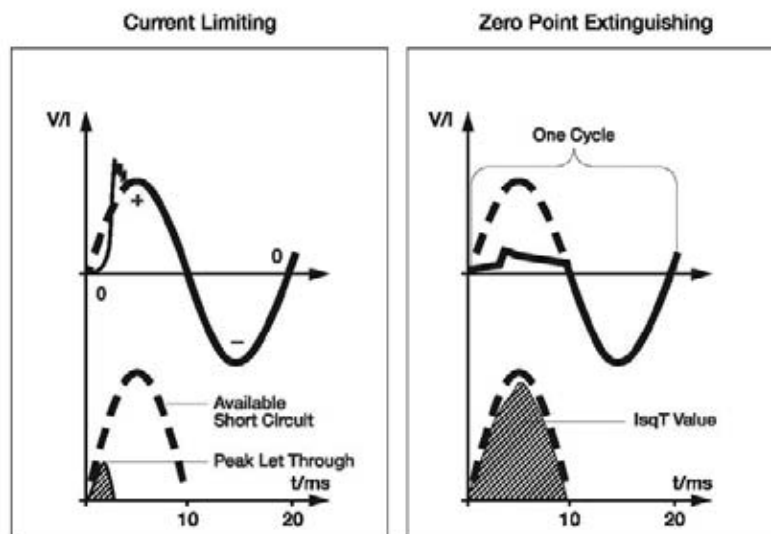

Current limiting and zero crossing breakers

During the initial stages of a short circuit a breaker's contacts open to interrupt the circuit. After the contacts open an arc forms in the air between the contacts on both the current limiting and zero crossing breaker contacts. What distinguishes a current limiting breaker from a zero crossing breaker is what each breaker does after an arc is formed between the open contacts.

A current limiting breaker "runs" the arc down the breaker arc runner into an arc chute that extinguishes the arc.

A zero crossing breaker does not attempt to extinguish the arc. The breaker is designed to withstand the energy of the arc long enough for the waveform to cross zero. When the wave form crosses zero the potential energy is zero and the arc naturally extinguishes itself.

ABB's current limiting breakers interrupt the arc energy in 2.3ms to 2.5ms (1/8 cycle) and a zero crossing breaker allows the arc to be present for up to 8.3ms (1/2 cycle). A zero crossing breaker will let through 100 times as much energy as an ABB current limiting breaker.

Current limiting example

The lab test report below details a 20A S200 series current limiting breaker interrupting a 28kA fault in 1.7 milliseconds. The total "I Square T" value is 32.0kA.

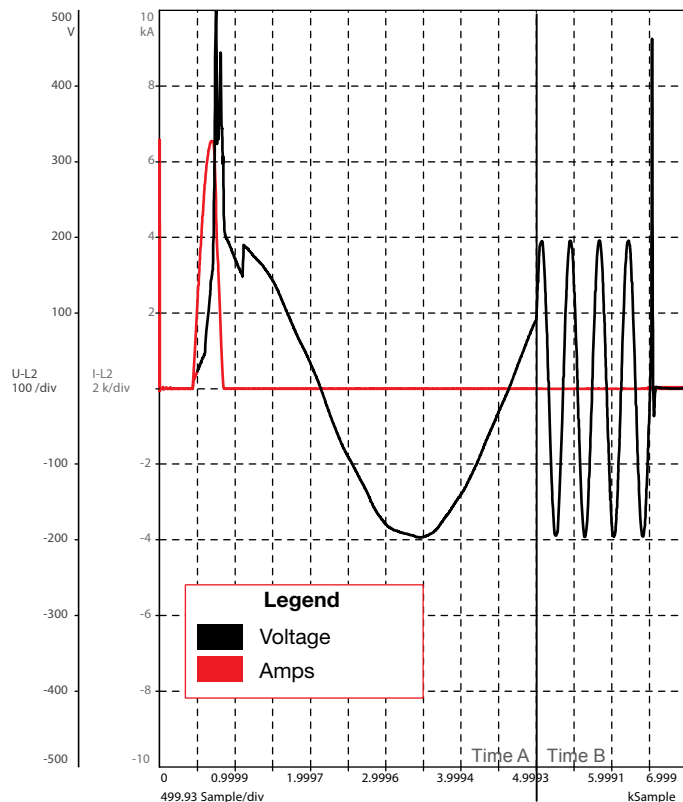
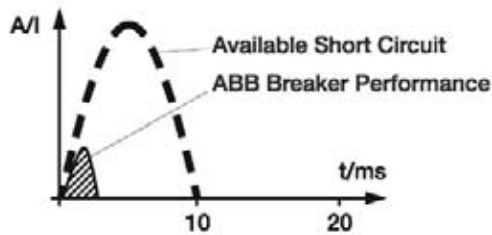

Zero crossing example

The test report below details a 20A Zero Point Extinguishing breaker interrupting a 9kA fault in 9 milliseconds. The total "I Square T" value is 104.0kA.

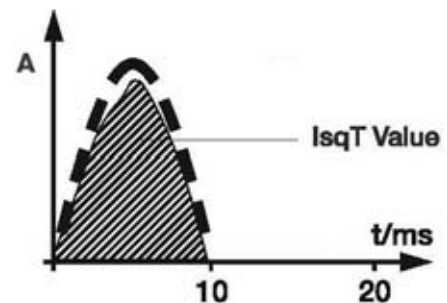
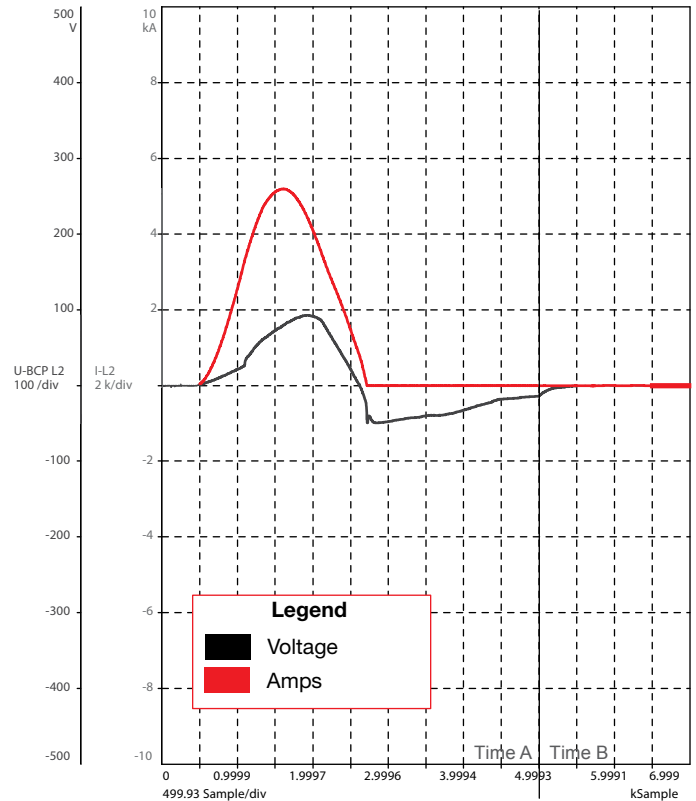

Selective coordination and series ratings

IEC 60497-1 selective coordination definition

Coordination between the operating characteristics of two or more over-current protection devices, so that when an over-current within established limits occurs, the device designated to operate within those limits trips whereas the other do not trip.

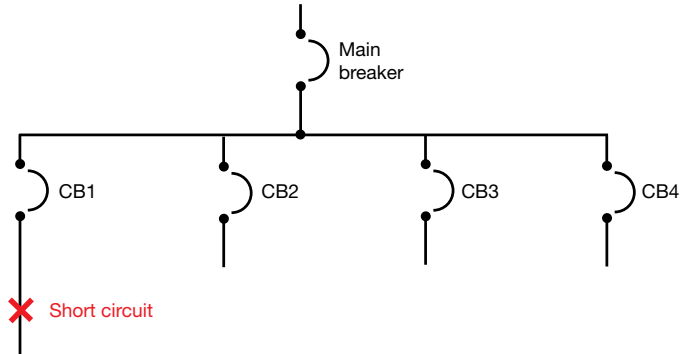

Example of breaker coordination

When an over-current event occurs at the branch breaker level (CB1), and the event is within the operating characteristics of the breaker, then the branch breaker should interrupt the circuit (open) and the main breaker should remain closed and energized. The chart below gives a graphical representation of a downstream branch breaker (B curve) and a main breaker (A curve) with coordination. The separation between the curves allows the branch breaker to react to the fault and the main breaker remain closed and energized.

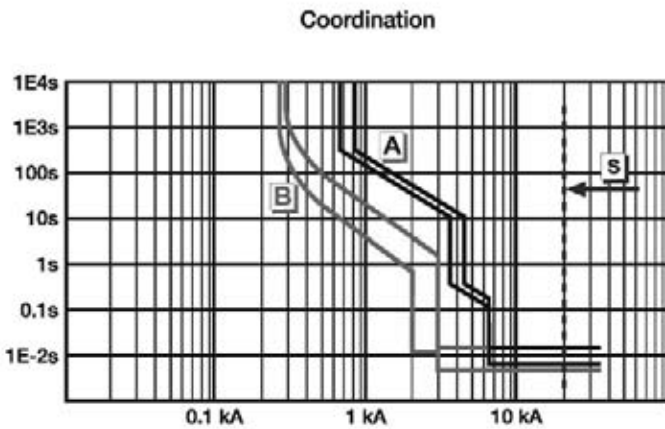

Example of no breaker coordination

Selective breaker coordination is not achieved when there is an overload event at the branch breaker level (MCB1) and both the branch breaker and main breaker interrupt the circuit (open). When there is no breaker coordination several circuits lose power that should remain operational during and after the overload event. The chart below gives a graphical representation of a downstream branch breaker (B curve) and a main breaker (A curve) without coordination. There is no separation between the curves. The branch breaker will react to a fault and the main breaker will open and de-energize all circuits downstream.

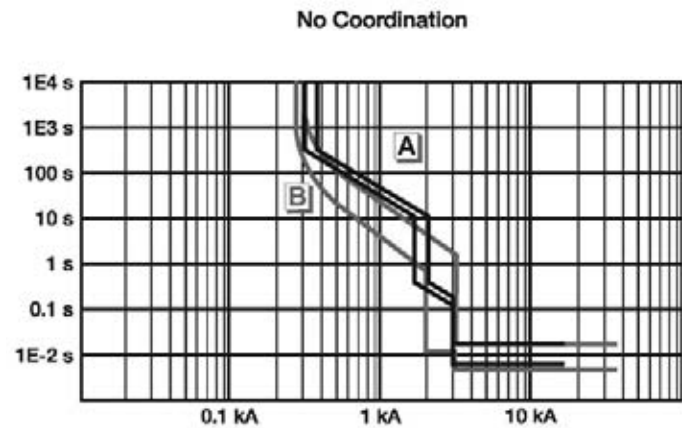

Problems in coordination occur when the branch breaker allows the "I Square T" value of the short circuit to rise to a level that is in the operating range of the up-stream main breaker. Proper breaker coordination is easier to achieve with the use of current limiting breakers at the branch level.

Selective coordination and current limiting breakers

Recent improvements in ABB circuit breaker technology has pushed the performance of breakers to the same level as fuses. The reaction time and tripping characteristics of current limiting breakers are now on par with fuses. This allows ABB to provide a high level of coordination between branch breakers and the main. A current limiting branch breaker will limit the "I Square T" value well below the level of the operating range of the up-stream main breaker.

ABB's current limiting branch breakers can coordinate between the main breaker up to 35kA.

Selective coordination and zero crossing breakers

Zero crossing breakers do not limit the "I Square T" value. They wait for the wave form to cross zero and allow a high level of let-through energy to pass through the system. The "I Square T" value of a zero crossing breaker is high enough that the main breaker will likely trip during a short circuit. With zero crossing breakers it is extremely difficult to coordinate between branch and main breakers.

A typical zero crossing breaker's coordination level is below 10kA. There are a few manufactures that have achieved coordination between a branch zero crossing breaker and the main by slowing the performance (protection) of the main breaker.

Series ratings –vs- selective coordination

Selective coordination

Selective coordination is achieved when there is a short circuit on a branch circuit breaker, the branch breaker opens and isolates the fault, and the main breaker remains closed. The rating is usually a value above the “stand alone” interrupting rating of the branch breaker and the “stand alone” rating of the main breaker.

Example:

65kA rated main breaker

10kA rated branch breaker

Coordination between the two breakers up to 35kA

There can be a short circuit on the branch breaker up to 35kA where the branch will open (CB1) and the main breaker will remain closed. Although the branch has a 10kA “stand alone” rating both the breakers work together to limit the available short circuit to allow the branch (CB1) to isolate the fault.

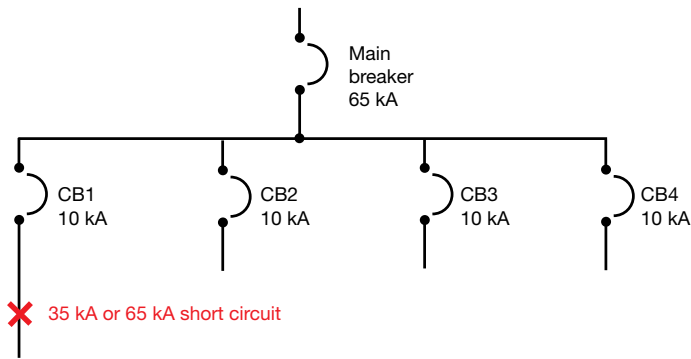

Series ratings

Series ratings are different from coordination ratings. Unlike coordination ratings where the branch opens and the main remains closed, a series rated combination is one where both the branch and main breakers open and work together to isolate the fault.

The series rating combination of two breakers is equal to the “stand alone” interrupting value of the main breaker. This is a result of the main breaker let-through value being lower than the “stand alone” interrupting value of the branch breaker. During a short circuit the main breaker will limit the energy to a level that is below the “stand alone” value of the branch breaker.

Example:

65kA rated main breaker

10kA rated branch breaker

Series combination rating between the two breakers up to 65kA

There can be a short circuit on the branch breaker up to 65kA where the branch will open and the main breaker will open. Although the branch breaker (CB1) has a 10kA “stand alone” rating the main breaker has a let-through value below 10kA. If there is a fault up to 65kA on the network the main breaker will limit the energy to a value less than the rating of the branch breaker (CB1). Both breakers will trip (no coordination) but the network can safely withstand a fault of 65kA.

Miniature circuit breaker cutaway

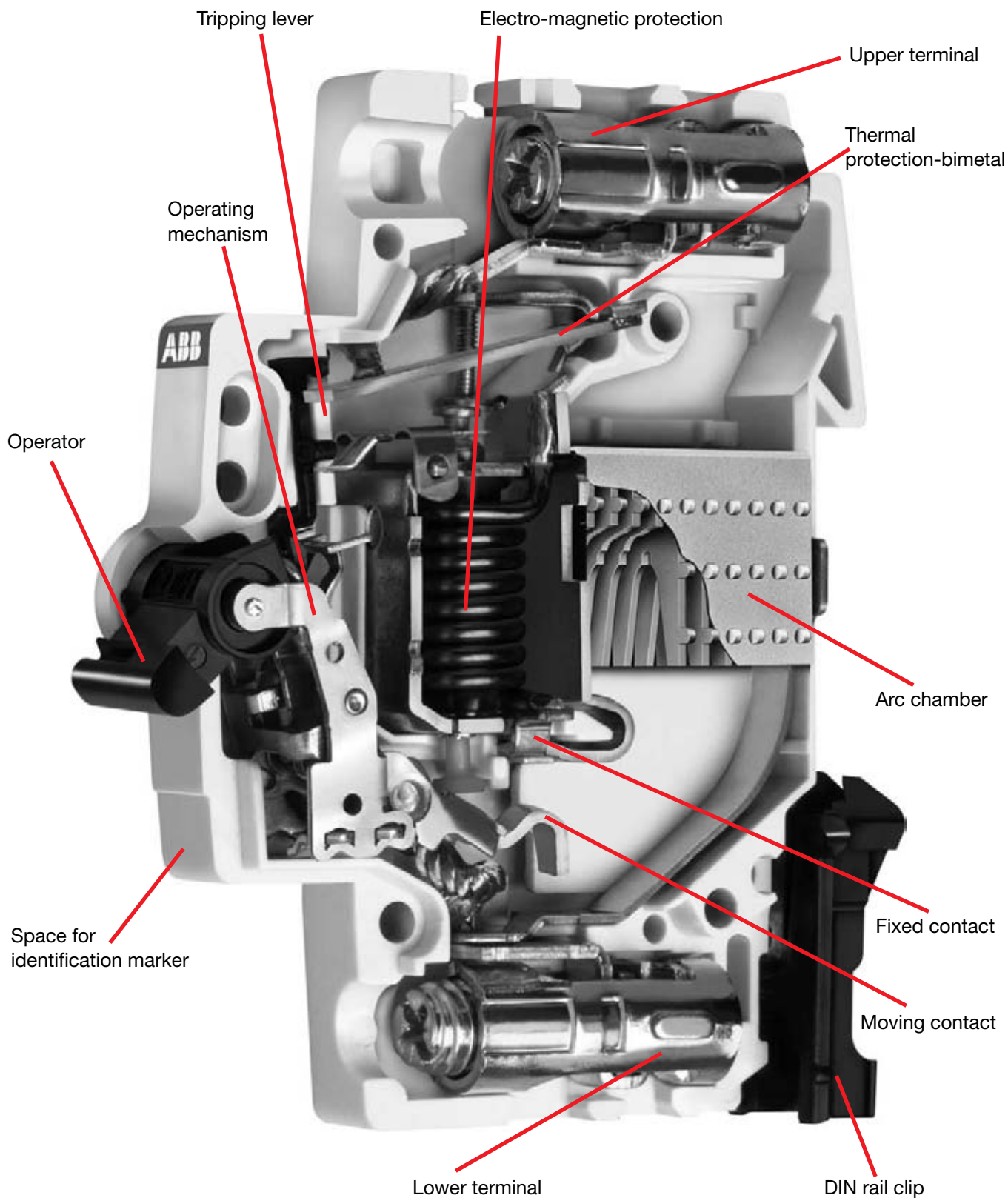

S800 Series High Performance Circuit Breakers

ABB S800
UL 489 Series



Description

The S800 high performance MCB offers a compact solution to circuit protection. The S800 devices are UL tested current limiting and DIN rail mounted. The S800 is available with application-specific trip characteristics to provide maximum circuit protection.

The breakers offer thermal-magnetic trip protection according to Z and K characteristics.

For the worldwide market, the breakers carry CSA, IEC, CE and many other agency approvals.

Features

- Current limiting
- Fast breaking time (2.3 – 2.5 ms)
- Wide range of accessories
- DIN rail mounting
- Finger safe terminals
- Multi-function terminals
- Ring tongue compatible
- UL489 File # E312425

	S800U
Amperage	10 – 100 A
Voltage	240 VAC
Poles	1, 2, 3, 4 poles
Trip characteristics	Z, K
Interrupting ratings	50kA : UL 489
Auxiliary contacts	Yes
Bell alarm	Yes
Shunt trip	Yes
Undervoltage release	Yes
Ring tongue	Yes

S800U-K, 240 VAC
Branch circuit protection
UL 489

K



S801U-K



S802U-K



S803U-K



S804U-K

No. of poles	Rated current	Catalog number	No. of poles	Rated current	Catalog number
1	10	S801U-K10	3	10	S803U-K10
	15	S801U-K15		15	S803U-K15
	20	S801U-K20		20	S803U-K20
	25	S801U-K25		25	S803U-K25
	30	S801U-K30		30	S803U-K30
	40	S801U-K40		40	S803U-K40
	50	S801U-K50		50	S803U-K50
	60	S801U-K60		60	S803U-K60
	70	S801U-K70		70	S803U-K70
	80	S801U-K80		80	S803U-K80
90	S801U-K90	90	S803U-K90		
100	S801U-K100	100	S803U-K100		
2	10	S802U-K10	4	10	S804U-K10
	15	S802U-K15		15	S804U-K15
	20	S802U-K20		20	S804U-K20
	25	S802U-K25		25	S804U-K25
	30	S802U-K30		30	S804U-K30
	40	S802U-K40		40	S804U-K40
	50	S802U-K50		50	S804U-K50
	60	S802U-K60		60	S804U-K60
	70	S802U-K70		70	S804U-K70
	80	S802U-K80		80	S804U-K80
90	S802U-K90	90	S804U-K90		
100	S802U-K100	100	S804U-K100		

Tripping characteristic K

UL 489
240 VAC
50 kA

Resistive loads

- K Curve
- Designed for use in cable protection applications
- Example: control circuits, lighting

Accessories & technical data

Accessories – See page 52

Technical data – See page 76 - 82

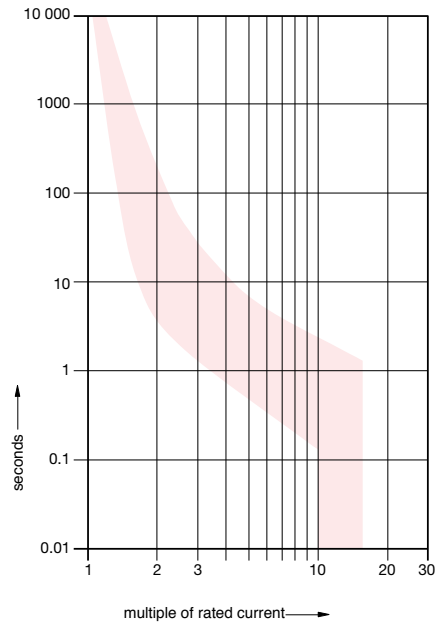

S800U-Z, 240 VAC

Branch circuit protection

UL 489

S800
Miniature
circuit breakers

Z



S801U-Z



S802U-Z



S803U-Z



S804U-Z

No. of poles	Rated current	Catalog number	No. of poles	Rated current	Catalog number
1	10	S801U-Z10	3	10	S803U-Z10
	15	S801U-Z15		15	S803U-Z15
	20	S801U-Z20		20	S803U-Z20
	25	S801U-Z25		25	S803U-Z25
	30	S801U-Z30		30	S803U-Z30
	40	S801U-Z40		40	S803U-Z40
	50	S801U-Z50		50	S803U-Z50
	60	S801U-Z60		60	S803U-Z60
	70	S801U-Z70		70	S803U-Z70
	80	S801U-Z80		80	S803U-Z80
90	S801U-Z90	90	S803U-Z90		
100	S801U-Z100	100	S803U-Z100		
2	10	S802U-Z10	4	10	S804U-Z10
	15	S802U-Z15		15	S804U-Z15
	20	S802U-Z20		20	S804U-Z20
	25	S802U-Z25		25	S804U-Z25
	30	S802U-Z30		30	S804U-Z30
	40	S802U-Z40		40	S804U-Z40
	50	S802U-Z50		50	S804U-Z50
	60	S802U-Z60		60	S804U-Z60
	70	S802U-Z70		70	S804U-Z70
	80	S802U-Z80		80	S804U-Z80
90	S802U-Z90	90	S804U-Z90		
100	S802U-Z100	100	S804U-Z100		

Tripping characteristic Z

UL 489
240 VAC
50 kA

Resistive loads

- Z Curve
- Designed for use in cable protection applications
- Example: control circuits, lighting

Accessories & technical data

Accessories – See page 15.52

Technical data – See page 15.76 - 82

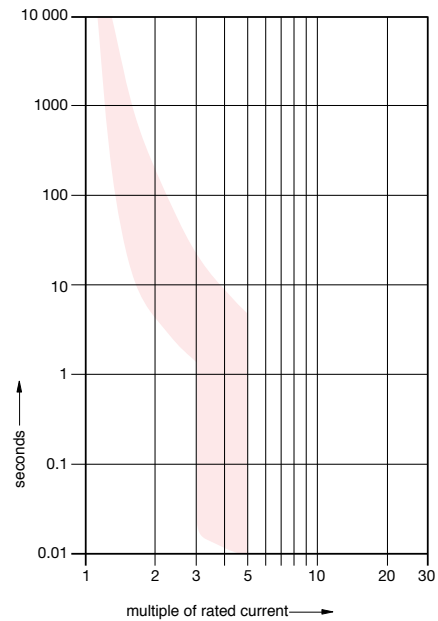



Description

The S800 high performance MCB offers a compact solution to circuit protection. The S800 devices are IEC tested current limiting and DIN rail mounted. The S800 is available with application-specific trip characteristics to provide maximum circuit protection.

The breakers offer thermal-magnetic trip protection according to B, C, D & K characteristics.

For the worldwide market, the breakers carry CSA, IEC, CE and many other agency approvals.

Features

- Current limiting
- Fast breaking time (2.3 – 2.5 ms)
- Wide range of accessories
- DIN rail mounting
- Finger safe terminals
- Multi-function terminals
- Ring tongue compatible

S800S

Amperage	10 – 125 A
Voltage	690 VAC
Poles	1, 2, 3, 4
Trip characteristics	B, C, D, K
Interrupting ratings	50 kA : IEC
Auxiliary contacts	Yes
Bell alarm	Yes
Shunt trip	Yes
Undervoltage release	Yes
Ring tongue	Yes

S800S-B, 690 VAC IEC

B



S801U-B



S802U-B



S803U-B



S804U-B

No. of poles	Rated current	Catalog number	No. of poles	Rated current	Catalog number
1	10	S801S-B10	3	10	S803S-B10
	13	S801S-B13		13	S803S-B13
	16	S801S-B16		16	S803S-B16
	20	S801S-B20		20	S803S-B20
	25	S801S-B25		25	S803S-B25
	32	S801S-B32		32	S803S-B32
	40	S801S-B40		40	S803S-B40
	50	S801S-B50		50	S803S-B50
	63	S801S-B63		63	S803S-B63
	80	S801S-B80		80	S803S-B80
	100	S801S-B100		100	S803S-B100
	125	S801S-B125		125	S803S-B125
2	10	S802S-B10	4	10	S804S-B10
	13	S802S-B13		13	S804S-B13
	16	S802S-B16		16	S804S-B16
	20	S802S-B20		20	S804S-B20
	25	S802S-B25		25	S804S-B25
	32	S802S-B32		32	S804S-B32
	40	S802S-B40		40	S804S-B40
	50	S802S-B50		50	S804S-B50
	63	S802S-B63		63	S804S-B63
	80	S802S-B80		80	S804S-B80
	100	S802S-B100		100	S804S-B100
	125	S802S-B125		125	S804S-B125

Tripping characteristic B

IEC
690 VAC
50 kA

Resistive loads

- B Curve
- Designed for use in cable protection applications
- Example: control circuits, lighting

Accessories & technical data

Accessories – See page 52

Technical data – See page 76 - 82

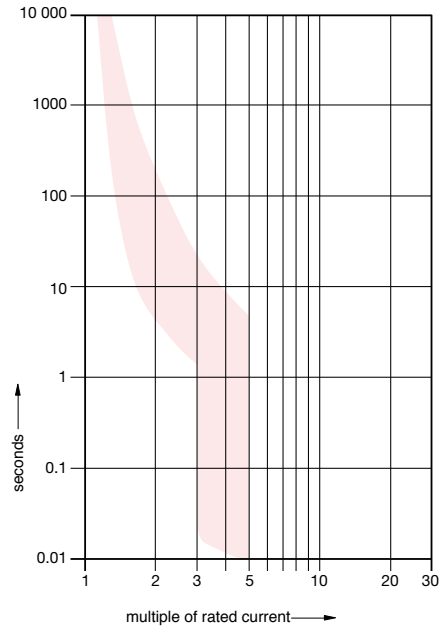

S800S-C, 690 VAC IEC

S800
Miniature
circuit breakers

C



S801S-C



S802S-C



S803S-C



S804S-C

No. of poles	Rated current	Catalog number	No. of poles	Rated current	Catalog number
1	10	S801S-C10	3	10	S803S-C10
	13	S801S-C13		13	S803S-C13
	16	S801S-C16		16	S803S-C16
	20	S801S-C20		20	S803S-C20
	25	S801S-C25		25	S803S-C25
	32	S801S-C32		32	S803S-C32
	40	S801S-C40		40	S803S-C40
	50	S801S-C50		50	S803S-C50
	63	S801S-C63		63	S803S-C63
	80	S801S-C80		80	S803S-C80
	100	S801S-C100		100	S803S-C100
	125	S801S-C125		125	S803S-C125
2	10	S802S-C10	4	10	S804S-C10
	13	S802S-C13		13	S804S-C13
	16	S802S-C16		16	S804S-C16
	20	S802S-C20		20	S804S-C20
	25	S802S-C25		25	S804S-C25
	32	S802S-C32		32	S804S-C32
	40	S802S-C40		40	S804S-C40
	50	S802S-C50		50	S804S-C50
	63	S802S-C63		63	S804S-C63
	80	S802S-C80		80	S804S-C80
	100	S802S-C100		100	S804S-C100
	125	S802S-C125		125	S804S-C125

Tripping characteristic C

IEC
690 VAC
50 kA

Resistive loads

- C Curve
- Designed for use with medium magnetic start up currents
- Example: lighting, control panels

Accessories & technical data

Accessories – See page 52

Technical data – See page 76 - 82

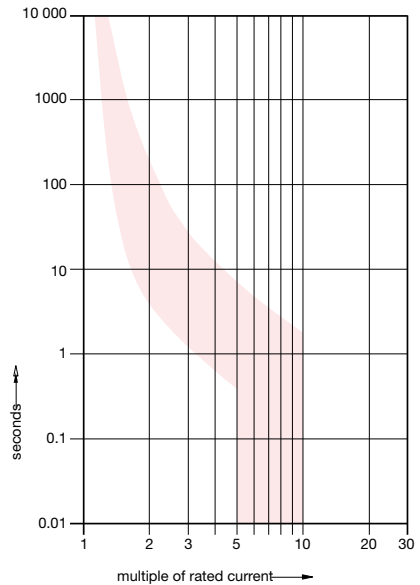

S800S-D, 690 VAC
IEC

D



S801S-D



S802S-D



S803S-D



S804S-D

No. of poles	Rated current	Catalog number	No. of poles	Rated current	Catalog number
1	10	S801S-D10	3	10	S803S-D10
	13	S801S-D13		13	S803S-D13
	16	S801S-D16		16	S803S-D16
	20	S801S-D20		20	S803S-D20
	25	S801S-D25		25	S803S-D25
	32	S801S-D32		32	S803S-D32
	40	S801S-D40		40	S803S-D40
	50	S801S-D50		50	S803S-D50
	63	S801S-D63		63	S803S-D63
	80	S801S-D80		80	S803S-D80
	100	S801S-D100		100	S803S-D100
	125	S801S-D125		125	S803S-D125
2	10	S802S-D10	4	10	S804S-D10
	13	S802S-D13		13	S804S-D13
	16	S802S-D16		16	S804S-D16
	20	S802S-D20		20	S804S-D20
	25	S802S-D25		25	S804S-D25
	32	S802S-D32		32	S804S-D32
	40	S802S-D40		40	S804S-D40
	50	S802S-D50		50	S804S-D50
	63	S802S-D63		63	S804S-D63
	80	S802S-D80		80	S804S-D80
	100	S802S-D100		100	S804S-D100
	125	S802S-D125		125	S804S-D125

Tripping characteristic D

IEC
690 VAC
50 kA

Inductive loads

- D Curve
- Designed for allowing higher in-rush currents during system start up
- Example: motors, transformers

Accessories & technical data

Accessories – See page 52

Technical data – See page 76 - 82

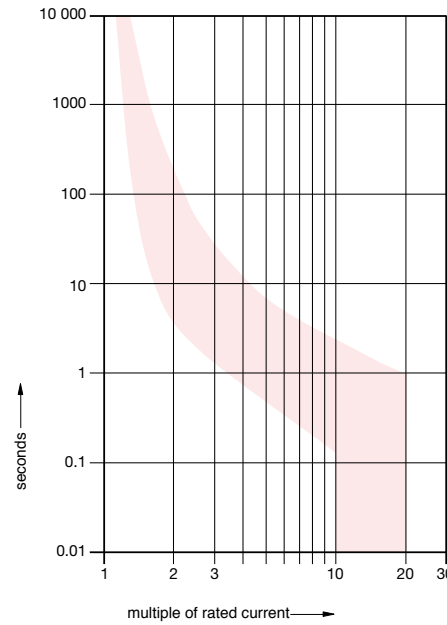

S800S-K, 690 VAC IEC

S800
Miniature
circuit breakers

K



S801S-K



S802S-K



S803S-K



S804S-K

No. of poles	Rated current	Catalog number	No. of poles	Rated current	Catalog number
1	10	S801S-K10	3	10	S803S-K10
	13	S801S-K13		13	S803S-K13
	16	S801S-K16		16	S803S-K16
	20	S801S-K20		20	S803S-K20
	25	S801S-K25		25	S803S-K25
	32	S801S-K32		32	S803S-K32
	40	S801S-K40		40	S803S-K40
	50	S801S-K50		50	S803S-K50
	63	S801S-K63		63	S803S-K63
	80	S801S-K80		80	S803S-K80
	100	S801S-K100		100	S803S-K100
125	S801S-K125	125	S803S-K125		
2	10	S802S-K10	4	10	S804S-K10
	13	S802S-K13		13	S804S-K13
	16	S802S-K16		16	S804S-K16
	20	S802S-K20		20	S804S-K20
	25	S802S-K25		25	S804S-K25
	32	S802S-K32		32	S804S-K32
	40	S802S-K40		40	S804S-K40
	50	S802S-K50		50	S804S-K50
	63	S802S-K63		63	S804S-K63
	80	S802S-K80		80	S804S-K80
	100	S802S-K100		100	S804S-K100
125	S802S-K125	125	S804S-K125		

Tripping characteristic K

IEC
690 VAC
50 kA

Inductive loads

- K Curve
- Designed for allowing higher in-rush currents during system start up
- Example: motors, transformers

Accessories & technical data

Accessories – See page 52

Technical data – See page 76 - 82

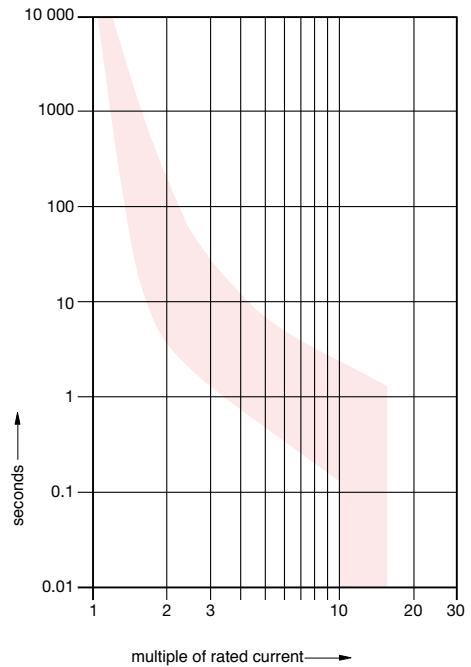

Accessories S800 & S800S



S800-SOR

Shunt trip

For remote tripping of breaker, a shunt trip device can be added to the MCB. The device opens the breaker after control voltage is applied.

Description (for field mounting, left side)	Catalog number
Shunt operation release 24 VAC/DC	S800-SOR24
Shunt operation release 48...130 VAC/DC	S800-SOR130
Shunt operation release 110...250 VAC/DC	S800-SOR250

Undervoltage release

When control voltage drops below approximately 50 % of rated voltage, the UVR opens the breaker. The breaker can not be operated unless proper control voltage is first applied to the UVR coil.

Description	Catalog number
Under voltage release 24...36 VAC/DC	S800-UVR36
Under voltage release 48...60 VAC/DC	S800-UVR60
Under voltage release 110...130 VAC/DC	S800-UVR130
Under voltage release 220...250 VAC/DC	S800-UVR250



S800-UVR

Auxiliary contacts

The auxiliary contacts will signal whether the breaker is in the ON or OFF position.

Description	Catalog number
Auxiliary contact	S800-AUX

Bell alarm

The bell alarm includes a set of contacts that will only signal when the breaker has tripped. Typically the contacts would be connected to an alarm or bell to signal the operator that an overcurrent trip has occurred. The bell alarm also includes a test button for testing the alarm contacts without opening the breaker.

Description	Catalog number
Bell alarm	S800-AUX/ALT



S800-AUX



S800-AUX/ALT

Accessories

S800U & S800S

S800
Miniature
circuit breakers



S800-RT2125

Ring tongue adaptor

Description	Catalog number
Ring terminal cable connection	S800-RT2125

Rotary operating mechanism

Allows “through the door” operation.



S800-RD

Description	Catalog number
Handle mechanism	S800-RD

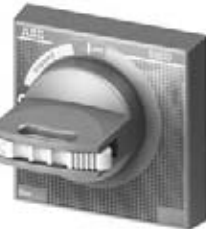

S800-RHE-H

Description	Catalog number
Grey rotary handle	S800-RHE-H



S800-RHE-EM

Description	Catalog number
Red rotary handle	S800-RHE-EM



S800-RHE-S

Description	Catalog number
Shaft extension	S800-RHE-S

Tripping Characteristic B

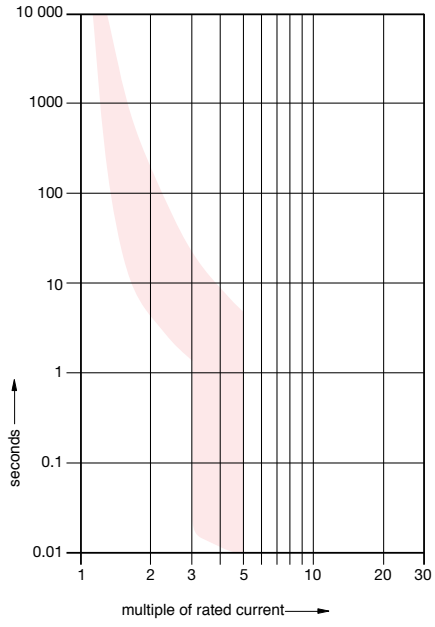

Tripping Characteristic C

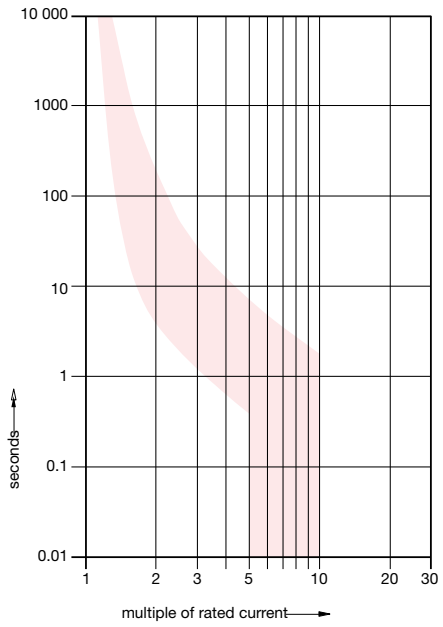

Tripping Characteristic D

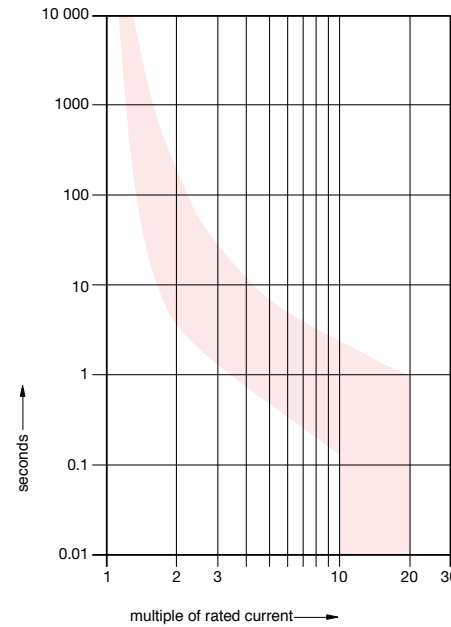

Tripping Characteristic K

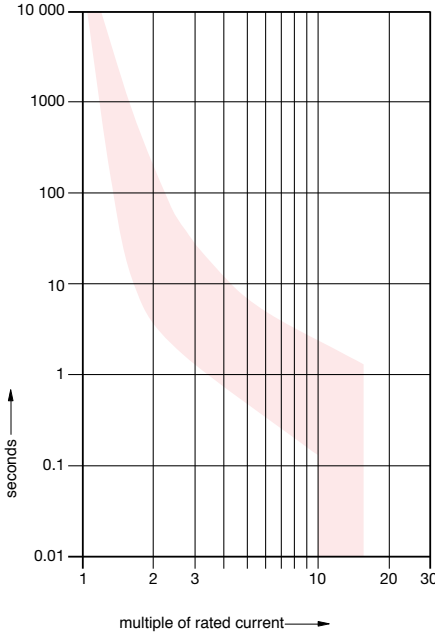

Tripping Characteristic Z

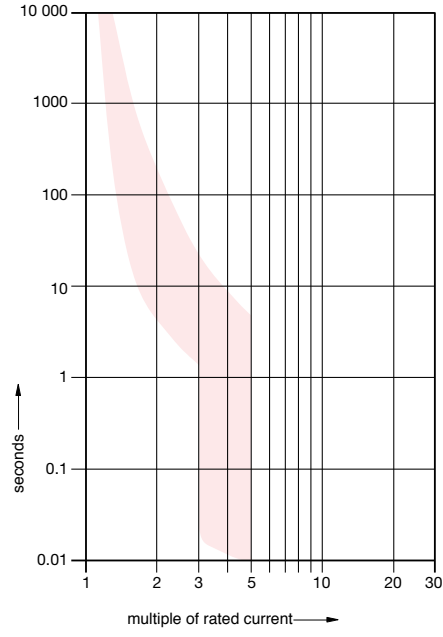

Technical data

S800S

IEC

S800
Miniature
circuit breakers

Internal resistance and power loss

Internal resistance per pole in mΩ, power loss per pole in W

Type	Rated current A	Device series	Power loss
		B C D K mΩ	B C D K W
S800S	10	15.2	1.5
	13	12.1	2.0
	16	12.1	3.1
	20	8.7	3.5
	25	6.8	4.2
	32	3.1	3.1
	40	2.3	3.7
	50	1.7	4.3
	63	1.6	6.2
	80	1.0	6.4
	100	0.8	8.3
	125	0.6	9.4

Temperature derating

Max. operating current values depending on the ambient temperature for a circuit-breaker in load circuit of type B, C, D, & K characteristics.

S800S-B, -C, -D In [A]	Ambient temperature T (°C/°F)										
	10/50	15/59	20/68	25/77	30/86	35/95	40/104	45/113	50/122	55/131	60/140
10	11.2	11.0	10.7	10.4	10.0	9.6	9.3	9.0	8.7	8.4	8.0
13	14.6	14.3	13.9	13.5	13.0	12.5	12.1	11.7	11.3	10.9	10.4
16	17.9	17.6	17.1	16.6	16.0	15.4	14.9	14.4	13.9	13.4	12.8
20	22.4	22.0	21.4	20.8	20.0	19.2	18.6	18.0	17.4	16.8	16.0
25	28.0	27.5	26.8	26.0	25.0	24.0	23.3	22.5	21.8	21.0	20.0
32	35.8	35.2	34.2	33.3	32.0	30.7	29.8	28.8	27.8	26.9	25.6
40	44.8	44.0	42.8	41.6	40.0	38.4	37.2	36.0	34.8	33.6	32.0
50	56.0	55.0	53.5	52.0	50.0	48.0	46.5	45.0	43.5	42.0	40.0
63	70.6	69.3	67.4	65.5	63.0	60.5	58.6	56.7	54.8	52.9	50.4
80	89.6	88.0	85.6	83.2	80.0	76.8	74.4	72.0	69.6	67.2	64.0
100	112.0	110.0	107.0	104.0	100.0	96.0	93.0	90.0	87.0	84.0	80.0
125	140.0	137.5	133.8	130.0	125.0	120.0	116.3	112.5	108.8	105.0	100.0

S800S-K In [A]	Ambient temperature T (°C/°F)										
	10/50	15/59	20/68	25/77	30/86	35/95	40/104	45/113	50/122	55/131	60/140
10	11.9	11.6	11.2	11.0	10.7	10.4	10.0	9.6	9.3	9.0	8.7
13	15.6	15.1	14.6	14.3	13.9	13.5	13.0	12.5	12.1	11.7	11.3
16	19.1	18.6	17.9	17.6	17.1	16.6	16.0	15.4	14.9	14.4	13.9
20	23.9	23.2	22.4	22.0	21.4	20.8	20.0	19.2	18.6	18.0	17.4
25	29.9	29.1	28.0	27.5	26.8	26.0	25.0	24.0	23.3	22.5	21.8
32	38.2	37.2	35.8	35.2	34.2	33.3	32.0	30.7	29.8	28.8	27.8
40	47.8	46.5	44.8	44.0	42.8	41.6	40.0	38.4	37.2	36.0	34.8
50	59.7	58.1	56.0	55.0	53.5	52.0	50.0	48.0	46.5	45.0	43.5
63	75.3	73.2	70.6	69.3	67.4	65.5	63.0	60.5	58.6	56.7	54.8
80	95.6	93.0	89.6	88.0	85.6	83.2	80.0	76.8	74.4	72.0	69.6
100	119.5	116.2	112.0	110.0	107.0	104.0	100.0	96.0	93	90.0	87.0
125	149.4	145.3	140.0	137.5	133.8	130.0	125.0	120.0	116.3	112.5	108.8

Approximate dimensions S800U & S800S

Dimension drawings in mm

S800-RD & S800-RHE

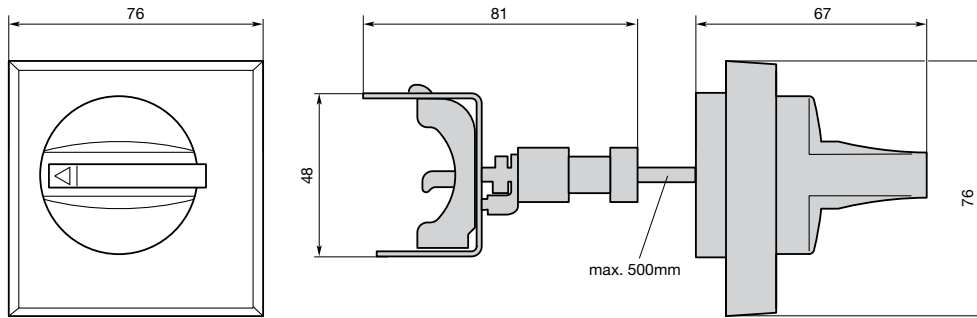

S800S & S800U

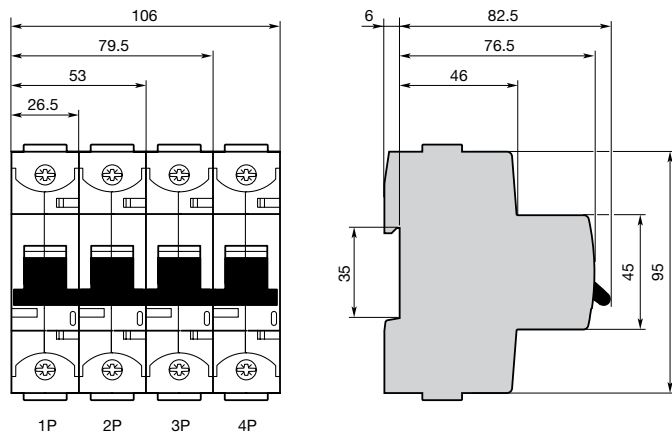

S800-SOR & S800-UVR

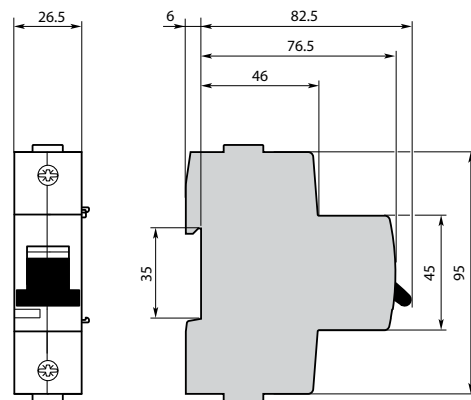

S800-AUX

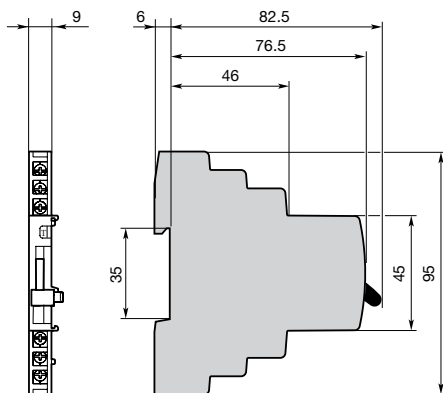

S800-AUX/ALT

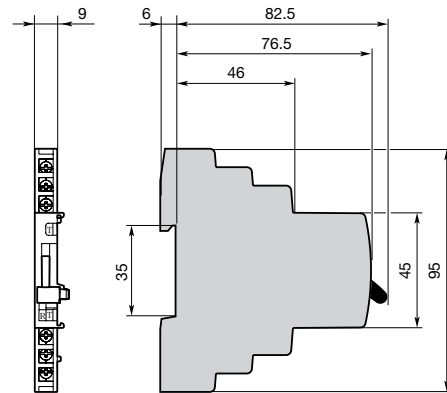

Technical data

S800U & S800S

Accessories

S800
Miniature
circuit breakers

Auxiliary contact S800-AUX

	S800-AUX
Usage category	AC15 400/2 A-UL AC15 240/ -UL DC13 250/0.55 A125 V/1.1A-IEC DC13 125 V/1.1A DC13 60 V/2A DC13 24 V/4A
Continuous thermal current I_n	6 A
Rated insulation voltage U_i	690 V
Number of contacts	2
Surge U_{test} (1.2/50 μ s)	6 kV
Degree of protection	3
Function of contact	Changeover contacts
Connection Cu	1 x 2.5 mm ² 2 x 1.5 mm ²
Tightening torque	1 Nm
Ensured contacts during shake test acc. to IEC 68-2-6	5g, 20 frequency cycle at 24 VAC/DC, 5mA brief interrupt <10 ms
AC/DC supply	any EN 60715
Mounting on DIN top hat rail	EN 60715 IP20
Type of protection	IP20
Permissible ambient temperature for operations	-25...+60 °C; -13 °F... 140 °F
Storage temperature	-40...+70 °C; -40 °F... 158 °F
Mechanical device service life	6000 switching cycles
I_{cu} with S450E	1000 A
Resistance to vibration	IEC 60068-2-27; IEC 60068-2; EN 61373 Cat.1/class B

Undervoltage release S800-UVR

	S800-UVR36	S800-UVR60	S800-UVR130	S800-UVR250
Rated voltage U_e	24...36 VAC/DC	48...60 VAC/DC	110...130 VAC/DC	220...250 VAC/DC
Operating range				
Operating opening	35...70% U_e			
Operating closing	85% U_e			
Rated insulation voltage U_i	690 V			
Coil pull in consumption	1 W, 14 vA	1 W, 25 vA	1 W, 41 vA	1 W, 91 vA
Rated frequency	DC; 50/60 Hz			
Protection degree	3			
Connection Cu	1...35 cable			
Tightening torque	min.3/ max.4 Nm			
AC/DC supply	any			
DIN top hat rail	EN 60715			
Type of protection	IP20			
Permissible ambient temperature of operations	IP40 (only actuation side) -25...+60 °C; -13 °F... 140 °F			
Storage temperature	-40...+70 °C; -40 °F... 158 °F			
Resistance to vibration	IEC 60068-2-27; IEC 60068-2; EN61373 Cat.1/class B			

Combined auxiliary and bell alarm

Usage category	AC15 400/2A-UL AC15 240/6A-UL DC13 250/0.55A125V/1.1A-IEC DC13 125V/1.1A-IEC DC13 60V/2A DC13 24V/4A
Continuous thermal current I_n	6 A
Rated insulation voltage U_i	690 V
Number of contacts	2 (1x AUX, 1 x AUX/ALT)
Surge U_{test} (1.2/50 μ s)	6 kV
Degree of protection	3
Function of contact	Changeover contacts
Connection Cu	1 x 2.5 mm ² 2 x 1.5 mm ²
Tightening torque	1 Nm
Ensured contacts during shake test acc. to IEC 68-2-6	5g, 20 frequency cycle 5...150...5Hz at 24VAC/DC, 5mA brief interrupt <10ms
AC/DC supply	any EN 60715
Mounting on DIN top hat rail	EN 60715
Type of protection	IP20
Permissible ambient temperature for operations	-25 °C... 60 °C; -13 °F... 140 °F
Storage temperature	-40 °C... 70 °C; -40 °F... 150 °F
mech. Device service life	6000 switching cycles
I_{cu} with S450E	1000 A
Resistance to vibration	IEC 60068-2-27; IEC 60068-2; EN 61373 Cat.1/class B

Shunt operation release – S800-SOR

	S800-SOR24	S800-SOR130	S800-SOR250	S800-SOR400
Rated voltage U_e	24 VAC/DC	48...130 VAC/DC	110...250 VAC/DC	220...250
Operating range	70... 110% U_e			
Rated insulation voltage U_i	690 V			
Coil pull in consumption	19.2 W/vA	On request		
Rated frequency	DC; 50/60 Hz			
Degree of protection	3			
Connection Cu	1...35 AWG			
Tightening torque	min.3/ max.4 Nm			
AC/DC supply	any			
DIN top hat rail	EN 60715			
Type of protection	IP20; IP40 (only actuation side)			
Permissible ambient temperature of operations	-25 °C... 60 °C; -13 °F... 140 °F			
Storage temperature	-40 °C... 70 °C; -40 °F... 158 °F			
Resistance to vibration	IEC 60068-2-27; IEC 60068-2; EN61373 Cat.1/class B			

Technical data

Backup

S800S - S200 @ 230/400 V

S800
Miniature
circuit breakers

		E.		S800S								
L.	Char.	I _{cu} [kA]		B, C, D, K								
		I _n [A]	50									
			25	32	40	50	63	80	100	125		
S200	B	6	6	50	50	50	50	50	50	50	50	50
			10	50	50	50	50	50	50	50	50	
			13	50	50	50	50	50	50	50	50	
			16	50	50	50	50	50	50	50	50	
			20		50	50	50	50	50	50	50	
			25			50	50	50	50	50	50	
			32				50	50	50	50	50	
			40					50	50	50	50	
			50						50	50	50	
			63							50	50	

		E.		S800S							
L.	Char.	I _{cu} [kA]		B, C, D, K							
		I _n [A]	50								
			25	32	40	50	63	80	100	125	
S200P	B	25	6...16	50	50	50	50	50	50	50	50
			20		50	50	50	50	50	50	
			25			50	50	50	50	50	
			32				50	50	50	50	
		15	40					50	50	50	
			50						50	50	
			63							50	
											50

		E.		S800S											
L.	Char.	I _{cu} [kA]		B, C, D, K											
		I _n [A]	50												
			0.5...6	8	10	13	16	20	25	32	40	50	63	80	100
S200	C	6	0.5...6	50	50	50	50	50	50	50	50	50	50	50	50
			8	50	50	50	50	50	50	50	50	50	50	50	
			10	50	50	50	50	50	50	50	50	50	50	50	
			13	50	50	50	50	50	50	50	50	50	50	50	
			16	50	50	50	50	50	50	50	50	50	50	50	
			20		50	50	50	50	50	50	50	50	50	50	
			25			50	50	50	50	50	50	50	50	50	
			32				50	50	50	50	50	50	50	50	
			40					50	50	50	50	50	50	50	
			50						50	50	50	50	50	50	
63							50	50	50	50	50				

		E.		S800S									
L.	Char.	I _{cu} [kA]		B, C, D, K									
		I _n [A]	50										
			0.5...16	20	25	32	40	50	63	80	100	125	
S200P	C	25	0.5...16	50	50	50	50	50	50	50	50	50	50
			20		50	50	50	50	50	50	50		
			25			50	50	50	50	50	50		
			32				50	50	50	50	50		
		15	40					50	50	50	50		
			50						50	50	50		
			63							50	50		
											50		

LEGEND

E. = supply side

L. = load side

Back-up limit values are specified in kA

Technical data
Selectivity
S800S - S200 @ 230/400 V

L.	Char.	E.		S800S																	
		I _n [A]	I _{cu} [kA]	B																	
				25	32	40	50	63	80	100	125										
S200	B	6	6			0.4	0.5	0.7	1	1.5	2.6										
			10				0.4	0.6	0.7	1	1.4										
			13						0.5	0.7	0.9	1.3									
			16								0.7	0.9	1.3								
			20									0.9	1.3								
			25									0.9	1.3								
			32									0.8	1.1								
			40									0.8	1.1								
			50										1								
			63										0.9								

L.	Char.	E.		S800S																		
		I _n [A]	I _{cu} [kA]	B																		
				25	32	40	50	63	80	100	125											
S200	D	6	0.5	T	T	T	T	T	T	T	T	T	T	T	T	T	T	T	T	T		
			1	0.8	4.5	T	T	T	T	T	T	T	T	T	T	T	T	T	T	T	T	
			1.6	0.5	1	2.3	T	T	T	T	T	T	T	T	T	T	T	T	T	T	T	
			2	0.3	0.5	0.7	2.3	T	T	T	T	T	T	T	T	T	T	T	T	T	T	
			3		0.4	0.5	0.7	1.2	2.5	T	T	T	T	T	T	T	T	T	T	T	T	
			4		0.4	0.4	0.7	1	1.7	3	T	T	T	T	T	T	T	T	T	T	T	
			6				0.6	0.8	1.2	2	3.6	T	T	T	T	T	T	T	T	T	T	
			8					0.7	0.9	1.3	2	T	T	T	T	T	T	T	T	T	T	
			10						0.9	1.3	2	T	T	T	T	T	T	T	T	T	T	
			13							1	1.5	T	T	T	T	T	T	T	T	T	T	
			16																			
			20																			
			25																			
			32																			
			40																			
			50																			
			63																			

L.	Char.	E.		S800S																	
		I _n [A]	I _{cu} [kA]	B																	
				25	32	40	50	63	80	100	125										
S200	C	6	0.5	T	T	T	T	T	T	T	T	T	T	T	T	T	T	T	T	T	
			1	3.3	T	T	T	T	T	T	T	T	T	T	T	T	T	T	T	T	T
			1.6	0.6	1.3	T	T	T	T	T	T	T	T	T	T	T	T	T	T	T	T
			2	0.4	0.7	1.3	T	T	T	T	T	T	T	T	T	T	T	T	T	T	T
			3		0.4	0.6	0.7	1.1	2.6	T	T	T	T	T	T	T	T	T	T	T	T
			4		0.4	0.6	0.7	1	1.7	3.1	T	T	T	T	T	T	T	T	T	T	T
			6			0.4	0.5	0.7	1	1.5	2.6	T	T	T	T	T	T	T	T	T	T
			8				0.4	0.6	0.7	1	1.4	T	T	T	T	T	T	T	T	T	T
			10				0.4	0.6	0.7	1	1.4	T	T	T	T	T	T	T	T	T	T
			13					0.5	0.7	0.9	1.3	T	T	T	T	T	T	T	T	T	T
			16						0.7	0.9	1.3	T	T	T	T	T	T	T	T	T	T
			20							0.9	1.3	T	T	T	T	T	T	T	T	T	T
			25							0.9	1.3	T	T	T	T	T	T	T	T	T	T
			32							0.8	1.1	T	T	T	T	T	T	T	T	T	T
			40							0.8	1.1	T	T	T	T	T	T	T	T	T	T
50								1	T	T	T	T	T	T	T	T	T	T			
63								0.9	T	T	T	T	T	T	T	T	T	T			

L.	Char.	E.		S800S																	
		I _n [A]	I _{cu} [kA]	B																	
				25	32	40	50	63	80	100	125										
S200	K	6	0.5	T	T	T	T	T	T	T	T	T	T	T	T	T	T	T	T	T	
			1	0.8	5	T	T	T	T	T	T	T	T	T	T	T	T	T	T	T	T
			1.6	0.5	1	2.1	T	T	T	T	T	T	T	T	T	T	T	T	T	T	T
			2	0.3	0.5	0.7	2.1	T	T	T	T	T	T	T	T	T	T	T	T	T	T
			3		0.4	0.5	0.7	1.2	2.5	T	T	T	T	T	T	T	T	T	T	T	T
			4		0.4	0.4	0.7	1	1.7	3	T	T	T	T	T	T	T	T	T	T	T
			6				0.6	0.8	1.2	2	3.6	T	T	T	T	T	T	T	T	T	T
			8					0.7	0.9	1.3	2	T	T	T	T	T	T	T	T	T	T
			10						0.9	1.3	2	T	T	T	T	T	T	T	T	T	T
			13							1	1.5	T	T	T	T	T	T	T	T	T	T
			16																		
			20																		
			25																		
			32																		
			40																		
			50																		
			63																		

LEGEND

E. = supply side
L. = load side
Back-up limit values are specified in kA

Technical data

Selectivity

S800S - S200 @ 230/400 V

S800
Miniature
circuit breakers

L.	Char.	I _{cu} [kA]	E.		S800S							
			C									
			I _n [A]	25	32	40	50	63	80	100	125	
S200	B	6	6		0.4	0.5	0.7	0.9	1.4	2.4	4.8	
			10		0.3	0.4	0.5	0.7	0.9	1.3	2	
			13		0.3	0.4	0.5	0.7	0.9	1.3	1.9	
			16		0.3	0.4	0.5	0.7	0.9	1.3	1.9	
			20		0.4	0.5	0.7	0.9	1.2	1.8		
			25		0.4	0.5	0.7	0.9	1.2	1.8		
			32			0.5	0.6	0.8	1	1.4		
			40				0.6	0.8	1	1.4		
			50					0.7	0.9	1.3		
			63						0.9	1.2		

L.	Char.	I _{cu} [kA]	E.		S800S							
			C									
			I _n [A]	25	32	40	50	63	80	100	125	
S200	C	6	0.5	T	T	T	T	T	T	T	T	T
			1	T	T	T	T	T	T	T	T	T
			1.6	0.6	T	T	T	T	T	T	T	T
			2	0.5	1	T	T	T	T	T	T	T
			3	0.3	0.5	0.7	1.2	2.1	T	T	T	
			4	0.3	0.4	0.7	1	1.5	2.6	T	T	
			6		0.4	0.5	0.7	0.9	1.4	2.4	4.8	
			8		0.3	0.4	0.5	0.7	0.9	1.3	2	
			10		0.3	0.4	0.5	0.7	0.9	1.3	2	
			13		0.3	0.4	0.5	0.7	0.9	1.3	1.9	
			16		0.3	0.4	0.5	0.7	0.9	1.3	1.9	
			20			0.4	0.5	0.7	0.9	1.2	1.8	
			25			0.4	0.5	0.7	0.9	1.2	1.8	
			32				0.5	0.6	0.8	1	1.4	
			40					0.6	0.8	1	1.4	
50						0.7	0.9	1.3				
63							0.9	1.2				

L.	Char.	I _{cu} [kA]	E.		S800S							
			C									
			I _n [A]	25	32	40	50	63	80	100	125	
S200	D	6	0.5	T	T	T	T	T	T	T	T	
			1	2.1	T	T	T	T	T	T	T	
			1.6	0.8	2.3	T	T	T	T	T	T	
			2	0.4	0.7	2.3	T	T	T	T	T	
			3	0.3	0.5	0.7	1.2	2.2	T	T	T	
			4	0.3	0.4	0.7	1	1.4	2.6	T	T	
			6		0.4	0.6	0.8	1.1	1.8	3.2	T	
			8			0.5	0.7	0.9	1.2	1.8	2.8	
			10				0.7	0.9	1.2	1.8	2.8	
			13					0.7	1	1.4	2	
			16						1	1.4	2	
			20							1	1.4	
			25								1.4	
			32									
			40									
50												
63												

L.	Char.	I _{cu} [kA]	E.		S800S							
			C									
			I _n [A]	25	32	40	50	63	80	100	125	
S200	K	6	0.5	T	T	T	T	T	T	T	T	
			1	2.1	T	T	T	T	T	T	T	
			1.6	0.8	2.3	T	T	T	T	T	T	
			2	0.4	0.7	2.3	T	T	T	T	T	
			3	0.3	0.5	0.7	1.2	2.2	T	T	T	
			4	0.3	0.4	0.7	1	1.4	2.6	T	T	
			6		0.4	0.6	0.8	1.1	1.8	3.2	T	
			8			0.5	0.7	0.9	1.2	1.8	2.8	
			10				0.7	0.9	1.2	1.8	2.8	
			13					0.7	1	1.4	2	
			16						1	1.4	2	
			20							1	1.4	
			25								1.4	
			32									
			40									
50												
63												

LEGEND

E. = supply side

L. = load side

Back-up limit values are specified in kA

Technical data
Selectivity
S800S - S200 @ 230/400 V

L.	Char.	E.		S800S									
		I _{cu} [kA]	I _n [A]	D									
				50									
S200	B	6	6	0.5	1	1.2	2	2.8	T	T	T		
			10	0.4	0.6	0.8	1.1	1.4	2.8	3.9	T	T	
			13	0.4	0.6	0.8	1.1	1.4	2.5	3.3	T	T	
			16		0.6	0.8	1.1	1.4	2.5	3.3	5.6	T	T
			20			0.8	1.1	1.3	2.3	3	4.7	T	T
			25			0.8	1.1	1.3	2.3	3	4.7	T	T
			32				0.9	1.1	1.9	2.4	3.7	T	T
			40					1.1	1.9	2.4	3.7	T	T
			50						1.5	1.9	2.3	T	T
			63							1.7	2.3	T	T

L.	Char.	E.		S800S							
		I _{cu} [kA]	I _n [A]	D							
				50							
S200	D	6	0.5	T	T	T	T	T	T	T	T
			1	T	T	T	T	T	T	T	T
			1.6	T	T	T	T	T	T	T	T
			2	2.3	T	T	T	T	T	T	T
			3	0.7	1.3	4.4	T	T	T	T	T
			4	0.7	1	2.2	4.4	T	T	T	T
			6	0.6	0.8	1.5	2.5	3.6	T	T	T
			8	0.5	0.7	1.1	1.5	2	4	5.5	T
			10	0.5	0.7	1.1	1.5	2	4	5.5	T
			13		0.6	0.9	1.2	1.5	2.6	3.4	5.2
			16			0.9	1.2	1.5	2.6	3.4	5.2
			20				0.9	1.1	1.8	2.2	3.2
			25					1.1	1.8	2.2	3.2
			32						1.7	2	2.9
			40							1.9	2.6
			50								2.2
			63								

L.	Char.	E.		S800S							
		I _{cu} [kA]	I _n [A]	D							
				50							
S200	C	6	0.5	T	T	T	T	T	T	T	T
			1	T	T	T	T	T	T	T	T
			1.6	T	T	T	T	T	T	T	T
			2	T	T	T	T	T	T	T	T
			3	0.7	2.2	4.4	T	T	T	T	T
			4	0.7	1.3	2.2	4.4	T	T	T	T
			6	0.5	1	1.2	2	2.8	T	T	T
			8	0.4	0.6	0.8	1.1	1.4	2.8	3.9	T
			10	0.4	0.6	0.8	1.1	1.4	2.8	3.9	T
			13	0.4	0.6	0.8	1.1	1.4	2.5	3.3	5.6
			16		0.6	0.8	1.1	1.4	2.5	3.3	5.6
			20			0.8	1.1	1.3	2.3	3	4.7
			25			0.8	1.1	1.3	2.3	3	4.7
			32				0.9	1.1	1.9	2.4	3.7
			40					1.1	1.9	2.4	3.7
			50						1.5	1.9	2.3
			63							1.7	2.3

L.	Char.	E.		S800S							
		I _{cu} [kA]	I _n [A]	D							
				50							
S200	K	6	0.5	T	T	T	T	T	T	T	T
			1	T	T	T	T	T	T	T	T
			1.6	T	T	T	T	T	T	T	T
			2	2.3	T	T	T	T	T	T	T
			3	0.7	1.3	4.4	T	T	T	T	T
			4	0.7	1	2.2	4.4	T	T	T	T
			6	0.6	0.8	1.5	2.5	3.6	T	T	T
			8	0.5	0.7	1.1	1.5	2	4	5.5	T
			10	0.5	0.7	1.1	1.5	2	4	5.5	T
			13		0.6	0.9	1.2	1.5	2.6	3.4	5.2
			16			0.9	1.2	1.5	2.6	3.4	5.2
			20				0.9	1.1	1.8	2.2	3.2
			25					1.1	1.8	2.2	3.2
			32						1.7	2	2.9
			40							1.9	2.6
			50								2.2
			63								

LEGEND

E. = supply side
L. = load side
Back-up limit values are specified in kA

Technical data

Selectivity

S800S - S200 @ 230/400 V

S800
Miniature
circuit breakers

		E.		S800S							
L.	Char.	I _{cu} [kA]	B								
			50								
		I _n [A]	25	32	40	50	63	80	100	125	
S200P	B	25	6			0.4	0.5	0.7	1	1.5	2.6
			10				0.4	0.6	0.7	1	1.4
			13					0.5	0.7	0.9	1.3
			16						0.7	0.9	1.3
			20							0.9	1.3
		25								0.9	1.3
		32								0.8	1.1
		40								0.8	1.1
		50									1
		63									

		E.		S800S							
L.	Char.	I _{cu} [kA]	C								
			50								
		I _n [A]	25	32	40	50	63	80	100	125	
S200P	B	25	6			0.4	0.5	0.7	1	1.5	2.6
			10				0.4	0.6	0.7	1	1.4
			13					0.5	0.7	0.9	1.3
			16						0.7	0.9	1.3
			20							0.9	1.3
		25								0.9	1.3
		32								0.8	1.1
		40								0.8	1.1
		50									1
		63									

		E.		S800S							
L.	Char.	I _{cu} [kA]	B								
			50								
		I _n [A]	25	32	40	50	63	80	100	125	
S200P	C	25	0.5	T	T	T	T	T	T	T	T
			1	3.3	T	T	T	T	T	T	T
			1.6	0.6	1.3	T	T	T	T	T	T
			2	0.4	0.7	1.2	T	T	T	T	T
			3			0.6	0.7	1.1	2.6	8.8	T
			4			0.6	0.7	1	1.7	3.1	7
			6			0.4	0.5	0.7	1	1.5	2.6
			8				0.4	0.6	0.7	1	1.4
		10				0.4	0.6	0.7	1	1.4	
		13					0.5	0.7	0.9	1.3	
		16						0.7	0.9	1.3	
		20							0.9	1.3	
		25								0.9	1.3
		32								0.8	1.1
		40								0.8	1.1
		50									1
63										0.9	

		E.		S800S								
L.	Char.	I _{cu} [kA]	C									
			50									
		I _n [A]	25	32	40	50	63	80	100	125		
S200P	C	25	0.5	T	T	T	T	T	T	T	T	
			1	3.3	T	T	T	T	T	T	T	
			1.6	0.6	1.3	T	T	T	T	T	T	
			2	0.4	0.7	1.3	T	T	T	T	T	
			3			0.4	0.6	0.7	1.1	2.6	8.8	T
			4			0.4	0.6	0.7	1	1.7	3.1	7
			6			0.4	0.5	0.7	1	1.5	2.6	
			8				0.4	0.6	0.7	1	1.4	
		10				0.4	0.6	0.7	1	1.4		
		13					0.5	0.7	0.9	1.3		
		16						0.7	0.9	1.3		
		20							0.9	1.3		
		25								0.9	1.3	
		32								0.8	1.1	
		40								0.8	1.1	
		50									1	
63										0.9		

		E.		S800S							
L.	Char.	I _{cu} [kA]	B								
			50								
		I _n [A]	25	32	40	50	63	80	100	125	
S200P	K	25	0.2	T	T	T	T	T	T	T	T
			0.3	T	T	T	T	T	T	T	T
			0.5	T	T	T	T	T	T	T	T
			0.75	T	T	T	T	T	T	T	T
			1	0.8	5	T	T	T	T	T	T
			1.6	0.5	1	2.3	T	T	T	T	T
			2	0.3	0.5	0.7	2.1	T	T	T	T
			3		0.4	0.5	0.7	1.2	2.5	8.6	T
		4		0.4	0.4	0.7	1	1.7	3	7.7	
		6				0.6	0.8	1.2	2	3.6	
		8					0.7	0.9	1.3	2	
		10						0.9	1.3	2	
		13							1	1.5	
		16								1.5	
		20									
		25									
32											
40											
50											
63											

		E.		S800S							
L.	Char.	I _{cu} [kA]	C								
			50								
		I _n [A]	25	32	40	50	63	80	100	125	
S200P	K	25	0.2	T	T	T	T	T	T	T	T
			0.3	T	T	T	T	T	T	T	T
			0.5	T	T	T	T	T	T	T	T
			0.75	T	T	T	T	T	T	T	T
			1	0.8	5	T	T	T	T	T	T
			1.6	0.5	1	2.3	T	T	T	T	T
			2	0.3	0.5	0.7	2.3	T	T	T	T
			3		0.4	0.5	0.7	1.2	2.5	8.6	T
		4		0.4	0.4	0.7	1	1.7	3	7.7	
		6				0.6	0.8	1.2	2	3.6	
		8					0.7	0.9	1.3	2	
		10						0.9	1.3	2	
		13							1	1.5	
		16								1.5	
		20									
		25									
32											
40											
50											
63											

LEGEND

E. = supply side

L. = load side

Back-up limit values are specified in kA

Technical data
Selectivity
S800S - S200P @ 230/400 V

L.	Char.	E.		S800S															
		I _{cu} [kA]	I _n [A]	D															
				25	32	40	50	63	80	100	125								
S200P	B	25	6	0.5	1	1.2	2	2.8	9.9	21.3	T								
			10	0.4	0.6	0.8	1.1	1.4	2.8	3.9	7.4								
			13	0.4	0.6	0.8	1.1	1.4	2.5	3.3	5.6								
			16		0.6	0.8	1.1	1.4	2.5	3.3	5.6								
			20			0.8	1.1	1.3	2.3	3	4.7								
			25			0.8	1.1	1.3	2.3	3	4.7								
			32				0.9	1.1	1.9	2.4	3.7								
		15	40					1.1	1.9	2.4	3.7								
			50							1.5	1.9	2.3							
			63								1.7	2.3							

L.	Char.	E.		S800S															
		I _{cu} [kA]	I _n [A]	D															
				25	32	40	50	63	80	100	125								
S200P	K	25	0.2	T	T	T	T	T	T	T	T	T	T	T	T	T	T	T	T
			0.3	T	T	T	T	T	T	T	T	T	T	T	T	T	T	T	T
			0.5	T	T	T	T	T	T	T	T	T	T	T	T	T	T	T	T
			0.75	T	T	T	T	T	T	T	T	T	T	T	T	T	T	T	T
			1	T	T	T	T	T	T	T	T	T	T	T	T	T	T	T	T
			1.6	T	T	T	T	T	T	T	T	T	T	T	T	T	T	T	T
			2	2.3	T	T	T	T	T	T	T	T	T	T	T	T	T	T	T
			3	0.7	1.3	4.4	T	T	T	T	T	T	T	T	T	T	T	T	T
			4	0.7	1	2.2	4.4	7.7	T	T	T	T	T	T	T	T	T	T	T
			6	0.6	0.8	1.5	2.5	3.6	12.1	24.2	T	T	T	T	T	T	T	T	T
			8	0.5	0.7	1.1	1.5	2	4	5.5	9.9								
			10	0.5	0.7	1.1	1.5	2	4	5.5	9.9								
			13		0.6	0.9	1.2	1.5	2.6	3.4	5.2								
			16			0.9	1.2	1.5	2.6	3.4	5.2								
			20				0.9	1.1	1.8	2.2	3.2								
			25						1.8	2.2	3.2								
			15	32						1.7	2	2.9							
				40							1.9	2.6							
				50								2.2							
				63															

L.	Char.	E.		S800S															
		I _{cu} [kA]	I _n [A]	D															
				25	32	40	50	63	80	100	125								
S200P	C	25	0.5	T	T	T	T	T	T	T	T	T	T	T	T	T	T	T	
			1	T	T	T	T	T	T	T	T	T	T	T	T	T	T	T	
			1.6	T	T	T	T	T	T	T	T	T	T	T	T	T	T	T	T
			2	T	T	T	T	T	T	T	T	T	T	T	T	T	T	T	T
			3	0.7	2.2	4.4	T	T	T	T	T	T	T	T	T	T	T	T	T
			4	0.7	1.3	2.2	4.4	7.7	T	T	T	T	T	T	T	T	T	T	T
			6	0.5	1	1.2	2	2.8	9.9	22	T	T	T	T	T	T	T	T	T
			8	0.4	0.6	0.8	1.1	1.4	2.8	3.9	7.4								
			10	0.4	0.6	0.8	1.1	1.4	2.8	3.9	7.4								
			13	0.4	0.6	0.8	1.1	1.4	2.5	3.3	5.6								
			16		0.6	0.8	1.1	1.4	2.5	3.3	5.6								
			20			0.8	1.1	1.3	2.3	3	4.7								
			25			0.8	1.1	1.3	2.3	3	4.7								
			15	32				0.9	1.1	1.9	2.4	3.7							
				40					1.1	1.9	2.4	3.7							
				50						1.5	1.9	2.3							
				63							1.7	2.3							

LEGEND

E. = supply side
L. = load side
Back-up limit values are specified in kA

Technical data

Selectivity

S800S - S280 @ 230/400 V

S800
Miniature
circuit breakers

		E.		S800S							
L.		Char.		B, C, D, K							
		I _{cu} [kA]		50							
		I _n [A]		25	32	40	50	63	80	100	125
S280	B	10	6	50	50	50	50	50	50	50	50
			10	50	50	50	25	20	16	16	16
		25	13	50	50	50	25	20	16	16	16
			16	50	50	50	25	20	16	16	16
			20		50	50	25	20	16	16	16
			25			50	25	20	16	16	16
	15	32				25	20	16	16	16	
		40					20	16	16	16	
	10	50						16	16	16	
		63							16	16	

		E.		S800S							
L.		Char.		B, C, D, K							
		I _{cu} [kA]		50							
		I _n [A]		25	32	40	50	63	80	100	125
S400E	B	6	6	50	50	50	50	50	50	50	50
			10	50	50	50	50	50	50	50	50
			13	50	50	50	50	50	50	50	50
			16	50	50	50	50	50	50	50	50
			20		50	50	50	50	50	50	50
			25			50	50	50	50	50	50
			32				50	50	50	50	50
			40					50	50	50	50
			50						50	50	50
			63							50	50

		E.		S800S							
L.		Char.		B, C, D, K							
		I _{cu} [kA]		50							
		I _n [A]		25	32	40	50	63	80	100	125
S280	C	10	3	50	50	50	50	50	50	50	50
			4	50	50	50	50	50	50	50	50
			6	50	50	50	50	50	50	50	50
			8	50	50	50	25	20	16	16	16
		25	10	50	50	50	25	20	16	16	16
			13	50	50	50	25	20	16	16	16
	16		50	50	50	25	20	16	16	16	
	20			50	50	25	20	16	16	16	
	15	25			50	25	20	16	16	16	
		32				25	20	16	16	16	
	10	40					20	16	16	16	
		50						16	16	16	
		63						16	16		

		E.		S800S							
L.		Char.		B, C, D, K							
		I _{cu} [kA]		50							
		I _n [A]		25	32	40	50	63	80	100	125
S400E	C	6	0.5...6	50	50	50	50	50	50	50	50
			8	50	50	50	50	50	50	50	50
			10	50	50	50	50	50	50	50	50
			13	50	50	50	50	50	50	50	50
			16	50	50	50	50	50	50	50	50
			20		50	50	50	50	50	50	50
			25			50	50	50	50	50	50
			32				50	50	50	50	50
			40					50	50	50	50
			50						50	50	50
			63							50	50

		E.		S800S							
L.		Char.		B, C, D, K							
		I _{cu} [kA]		50							
		I _n [A]		25	32	40	50	63	80	100	125
S280	K, Z	10	3	50	50	50	50	50	50	50	50
			4	50	50	50	50	50	50	50	50
			6	50	50	50	50	50	50	50	50
			8	50	50	50	25	20	16	16	16
		25	10	50	50	50	25	20	16	16	16
			13	50	50	50	25	20	16	16	16
	16		50	50	50	25	20	16	16	16	
	20			50	50	25	20	16	16	16	
	15	25			50	25	20	16	16	16	
		32				25	20	16	16	16	
	10	40					20	16	16	16	
		50						16	16	16	
		63						16	16		

LEGEND

E. = supply side

L. = load side

Back-up limit values are specified in kA

S500 Miniature Circuit Breakers



S500 Series
UL 1077

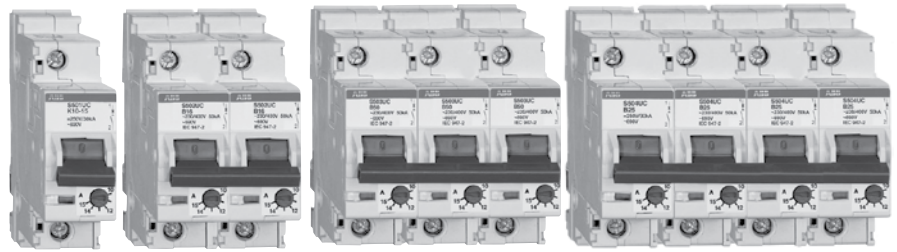

Description

The S500 high performance MCB offers a compact solution to circuit protection. The S500 devices are UL tested current limiting and DIN rail mounted. The S500 is available with application-specific trip characteristics to provide maximum circuit protection.

The breakers offer thermal-magnetic trip protection according to B and K characteristics.

For the worldwide market, the breakers carry CSA, IEC, CE and many other agency approvals.

Features

- High breaking capacity
- Fast breaking time (2.3 - 2.5 ms)
- Adjustable trip unit
- DIN rail mounting
- Finger safe terminals
- Multi-functional terminals
- Wide range of accessories
- UL 1077 recognized 600 VAC and 600 VDC versions
- UL1077 AC adjustable K
- UL1077 DC adjustable B, K
- UL File # E167556
- IEC #E60497-2

	S500	S500UC
Amperage	0.1 – 45 A	0.1 – 63 A
Voltage	UL: 600Y/277 VAC IEC: 690 VDC	UL: 600 VDC IEC: 750 VDC
Poles	1, 2, 3	1, 2, 3, 4
Trip characteristics	K	B, K
Interrupting ratings	30 kA: UL 1077 30 kA: CSA C22.2	30 kA: UL 1077 30 kA: CSA C22.2
Auxiliary contacts	Yes	Yes
Bell alarm	Yes	Yes
Shunt trip	No	No
Undervoltage release	No	No
Bus bar	Yes	Yes

S500-K, UL 600Y/277 VAC / IEC 690 VDC

Supplemental protection UL 1077, CSA 22.2, IEC

K



S501-K



S502-K

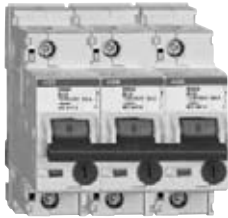

S503-K

No. of poles	Rated current	Catalog number	No. of poles	Rated current	Catalog number
1	0.1 - 0.15	S501-K0.15	3	0.1 - 0.15	S503-K0.15
	0.14 - 0.21	S501-K0.21		0.14 - 0.21	S503-K0.21
	0.2 - 0.3	S501-K0.3		0.2 - 0.3	S503-K0.3
	0.28 - 0.42	S501-K0.42		0.28 - 0.42	S503-K0.42
	0.38 - 0.58	S501-K0.58		0.38 - 0.58	S503-K0.58
	0.53 - 0.8	S501-K0.8		0.53 - 0.8	S503-K0.8
	0.73 - 1.1	S501-K1.1		0.73 - 1.1	S503-K1.1
	1 - 1.5	S501-K1.5		1 - 1.5	S503-K1.5
	1.4 - 2.1	S501-K2.1		1.4 - 2.1	S503-K2.1
	2 - 3	S501-K3		2 - 3	S503-K3
	2.8 - 4.2	S501-K4.2		2.8 - 4.2	S503-K4.2
	3.8 - 5.8	S501-K5.8		3.8 - 5.8	S503-K5.8
	5.3 - 8	S501-K8		5.3 - 8	S503-K8
	7.3 - 11	S501-K11		7.3 - 11	S503-K11
	10 - 15	S501-K15		10 - 15	S503-K15
	14 - 20	S501-K20		14 - 20	S503-K20
	18 - 26	S501-K26		18 - 26	S503-K26
23 - 32	S501-K32	23 - 32	S503-K32		
29 - 37	S501-K37	29 - 37	S503-K37		
34 - 41	S501-K41	34 - 41	S503-K41		
38 - 45	S501-K45	38 - 45	S503-K45		
2	0.1 - 0.15	S502-K0.15		0.1 - 0.15	S502-K0.15
	0.14 - 0.21	S502-K0.21		0.14 - 0.21	S502-K0.21
	0.2 - 0.3	S502-K0.3		0.2 - 0.3	S502-K0.3
	0.28 - 0.42	S502-K0.42		0.28 - 0.42	S502-K0.42
	0.38 - 0.58	S502-K0.58		0.38 - 0.58	S502-K0.58
	0.53 - 0.8	S502-K0.8		0.53 - 0.8	S502-K0.8
	0.73 - 1.1	S502-K1.1		0.73 - 1.1	S502-K1.1
	1 - 1.5	S502-K1.5		1 - 1.5	S502-K1.5
	1.4 - 2.1	S502-K2.1		1.4 - 2.1	S502-K2.1
	2 - 3	S502-K3		2 - 3	S502-K3
	2.8 - 4.2	S502-K4.2		2.8 - 4.2	S502-K4.2
	3.8 - 5.8	S502-K5.8		3.8 - 5.8	S502-K5.8
	5.3 - 8	S502-K8		5.3 - 8	S502-K8
	7.3 - 11	S502-K11		7.3 - 11	S502-K11
	10 - 15	S502-K15		10 - 15	S502-K15
	14 - 20	S502-K20		14 - 20	S502-K20
	18 - 26	S502-K26		18 - 26	S502-K26
23 - 32	S502-K32	23 - 32	S502-K32		
29 - 37	S502-K37	29 - 37	S502-K37		
34 - 41	S502-K41	34 - 41	S502-K41		
38 - 45	S502-K45	38 - 45	S502-K45		

Tripping characteristic K

UL 1077	IEC
600 VAC	690 VAC
30 kA	30 kA

Inductive loads

- K Curve
- Designed for allowing higher in-rush currents during system start up
- Example: motors, transformers

Accessories & technical data

Accessories - See page 71

Technical data - See page 76 - 82

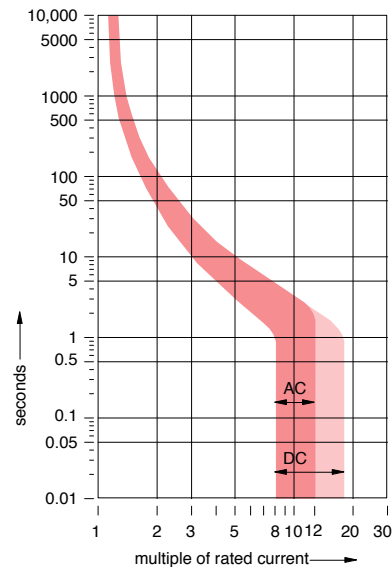

S500UC-B, UL 600 VDC / IEC 750 VDC

Supplemental protectors

UL1077, CSA 22.2, IEC

Miniature
circuit breakers

B



S501UC-B



S502UC-B



S503UC-B

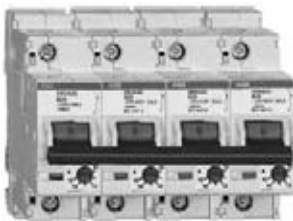

S504UC-B

No. of poles	Rated current	Catalog number	No. of poles	Rated current	Catalog number
1	6	S501UC-B6	3	6	S503UC-B6
	10	S501UC-B10		10	S503UC-B10
	13	S501UC-B13		13	S503UC-B13
	16	S501UC-B16		16	S503UC-B16
	20	S501UC-B20		20	S503UC-B20
	25	S501UC-B25		25	S503UC-B25
	32	S501UC-B32		32	S503UC-B32
	40	S501UC-B40		40	S503UC-B40
	50	S501UC-B50		50	S503UC-B50
	63	S501UC-B63	63	S503UC-B63	
2	6	S502UC-B6	4	6	S504UC-B6
	10	S502UC-B10		10	S504UC-B10
	13	S502UC-B13		13	S504UC-B13
	16	S502UC-B16		16	S504UC-B16
	20	S502UC-B20		20	S504UC-B20
	25	S502UC-B25		25	S504UC-B25
	32	S502UC-B32		32	S504UC-B32
	40	S502UC-B40		40	S504UC-B40
	50	S502UC-B50		50	S504UC-B50
	63	S502UC-B63	63	S504UC-B63	

Tripping characteristic B

UL 1077	IEC
600 VAC	750 VAC
30 kA	30 kA

Inductive loads

- B Curve
- Designed for allowing higher in-rush currents during system start up
- Example: motors, transformers

Accessories & technical data

Accessories – See page 71

Technical data – See page 76 - 82

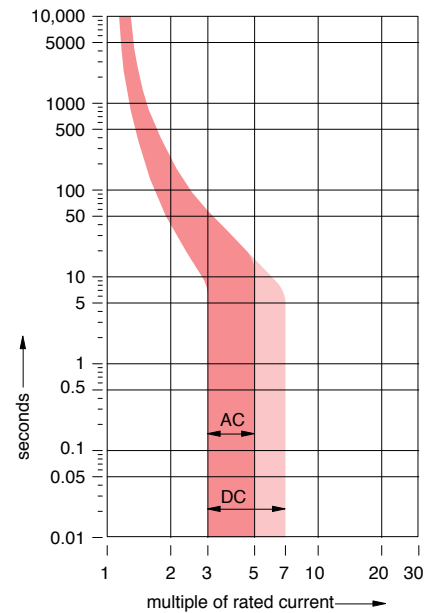

S500UC-K, UL 600 VDC / IEC 750 VDC

Supplemental protectors

UL1077, CSA 22.2, IEC

K



S501UC-K



S502UC-K

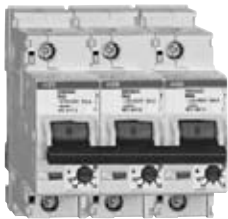

S503UC-K

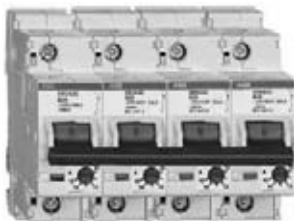

S504UC-K

No. of poles	Rated current	Catalog number	No. of poles	Rated current	Catalog number
1	0.1 – 0.15	S501UC-K0.15	3	0.1 – 0.15	S503UC-K0.15
	0.14 – 0.21	S501UC-K0.21		0.14 – 0.21	S503UC-K0.21
	0.2 – 0.3	S501UC-K0.3		0.2 – 0.3	S503UC-K0.3
	0.28 – 0.42	S501UC-K0.42		0.28 – 0.42	S503UC-K0.42
	0.38 – 0.58	S501UC-K0.58		0.38 – 0.58	S503UC-K0.58
	0.53 – 0.8	S501UC-K0.8		0.53 – 0.8	S503UC-K0.8
	0.73 – 1.1	S501UC-K1.1		0.73 – 1.1	S503UC-K1.1
	1 – 1.5	S501UC-K1.5		1 – 1.5	S503UC-K1.5
	1.4 – 2.1	S501UC-K2.1		1.4 – 2.1	S503UC-K2.1
	2 – 3	S501UC-K3		2 – 3	S503UC-K3
	2.8 – 4.2	S501UC-K4.2		2.8 – 4.2	S503UC-K4.2
	3.8 – 5.8	S501UC-K5.8		3.8 – 5.8	S503UC-K5.8
	5.3 – 8	S501UC-K8		5.3 – 8	S503UC-K8
	7.3 – 11	S501UC-K11		7.3 – 11	S503UC-K11
	10 – 15	S501UC-K15		10 – 15	S503UC-K15
	14 – 20	S501UC-K20		14 – 20	S503UC-K20
	18 – 26	S501UC-K26		18 – 26	S503UC-K26
	23 – 32	S501UC-K32		23 – 32	S503UC-K32
29 – 37	S501UC-K37	29 – 37	S503UC-K37		
34 – 41	S501UC-K41	34 – 41	S503UC-K41		
38 – 45	S501UC-K45	38 – 45	S503UC-K45		
2	0.1 – 0.15	S502UC-K0.15	4	0.1 – 0.15	S504UC-K0.15
	0.14 – 0.21	S502UC-K0.21		0.14 – 0.21	S504UC-K0.21
	0.2 – 0.3	S502UC-K0.3		0.2 – 0.3	S504UC-K0.3
	0.28 – 0.42	S502UC-K0.42		0.28 – 0.42	S504UC-K0.42
	0.38 – 0.58	S502UC-K0.58		0.38 – 0.58	S504UC-K0.58
	0.53 – 0.8	S502UC-K0.8		0.53 – 0.8	S504UC-K0.8
	0.73 – 1.1	S502UC-K1.1		0.73 – 1.1	S504UC-K1.1
	1 – 1.5	S502UC-K1.5		1 – 1.5	S504UC-K1.5
	1.4 – 2.1	S502UC-K2.1		1.4 – 2.1	S504UC-K2.1
	2 – 3	S502UC-K3		2 – 3	S504UC-K3
	2.8 – 4.2	S502UC-K4.2		2.8 – 4.2	S504UC-K4.2
	3.8 – 5.8	S502UC-K5.8		3.8 – 5.8	S504UC-K5.8
	5.3 – 8	S502UC-K8		5.3 – 8	S504UC-K8
	7.3 – 11	S502UC-K11		7.3 – 11	S504UC-K11
	10 – 15	S502UC-K15		10 – 15	S504UC-K15
	14 – 20	S502UC-K20		14 – 20	S504UC-K20
	18 – 26	S502UC-K26		18 – 26	S504UC-K26
	23 – 32	S502UC-K32		23 – 32	S504UC-K32
29 – 37	S502UC-K37	29 – 37	S504UC-K37		
34 – 41	S502UC-K41	34 – 41	S504UC-K41		
38 – 45	S502UC-K45	38 – 45	S504UC-K45		

Tripping characteristic K

UL 1077	IEC
600 VAC	750 VAC
30 kA	30 kA

Inductive loads

- K Curve
- Designed for allowing higher in-rush currents during system start up
- Example: motors, transformers

Accessories & technical data

Accessories – See page 71

Technical data – See page 76 - 82

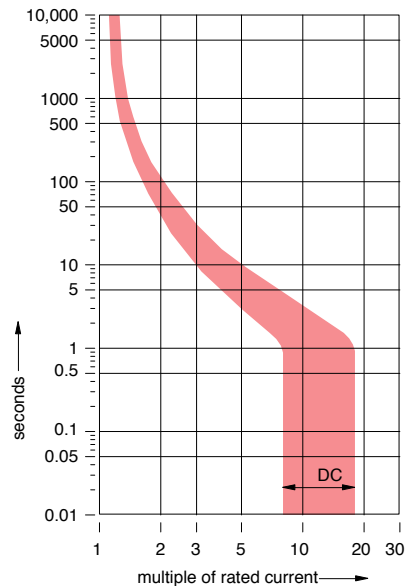

Accessories

S500 UL1077

Miniature
circuit breakers



S500-H11

Auxiliary contacts

The auxiliary contacts will signal whether the breaker is in the ON or OFF position.

Description	Catalog number
For field mounting: left side	
1 N.O./1 N.C.	S500-H11
2 N.O.	S500-H20
2 N.C.	S500-H02

Bell alarm

The bell alarm includes a set of contacts that will only signal when the breaker has tripped.

Typically the contacts would be connected to an alarm or bell to signal the operator that an overcurrent trip has occurred. The bell alarm also includes a test button for testing the alarm contacts without opening the breaker.

Description	Catalog number
For field mounting: left side	
1 N.O./1 N.C.	S500-S11
2 N.O.	S500-S20
2 N.C.	S500-S02

Handle mechanism

Description	Catalog number
Handle mechanism	S500-RD3

For use with 1-4 pole S500 MCBs and disconnect switch selector handles with 5mm shafts.

Power feed terminal - Accepts into 2/0 AWG

Description	Catalog number
Power feed terminal	S500-K2

Busbars – 3 phase L1, L2, L3

Amp rating	Number of poles	Busbar length (mm)	End cap catalog number	Catalog number
150	2	145	-	S500-BB23
	3	218	-	S500-BB33
	4	290	-	S500-BB43
	5	363	-	S500-BB53
	6	435	-	S500-BB63

Technical data S500-B & S500-K

Technical data	S500-B	S500-K
Approvals		
UL	1077	1077
CSA	C22.2 - No. 235	C22.2
Number of poles	1, 2, 3, +N, +NA	1, 2, 3, 4
Tripping characteristic	B, K	B, K
Rated currents	0.1 to 63 A	B: 6 - 63 A; K: 0.15 - 45 A
Rated voltage	277 VAC	277 VAC / 250 VDC
Frequency	50/60 Hz	50/60 Hz
Mounting position	vertical, horizontal	vertical, horizontal
Standard mounting	35mm DIN rail	35mm DIN rail
Clamps only for CU	16 - 4 AWG	16 - 4 AWG
Service life, mechanical at rated load	20,000	20,000
Ambient temperature	40°C... 104°F	40°C... 104°F

Tripping characteristic K

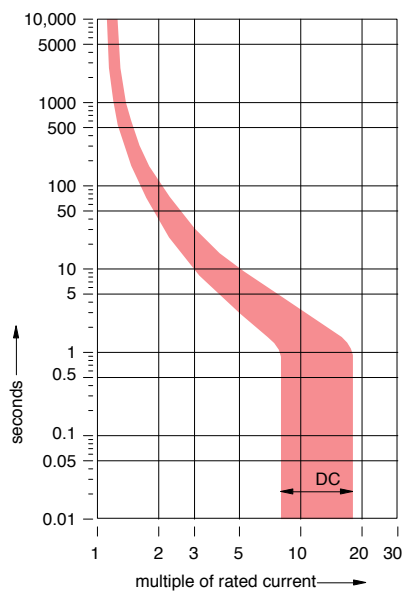

Tripping characteristic B

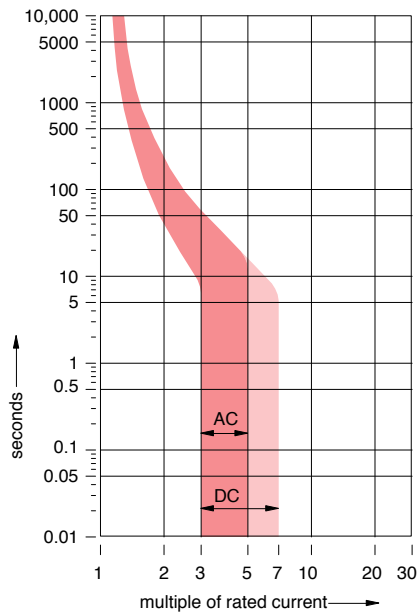

Approximate dimensions S500 & Accessories

Miniature
circuit breakers

S500

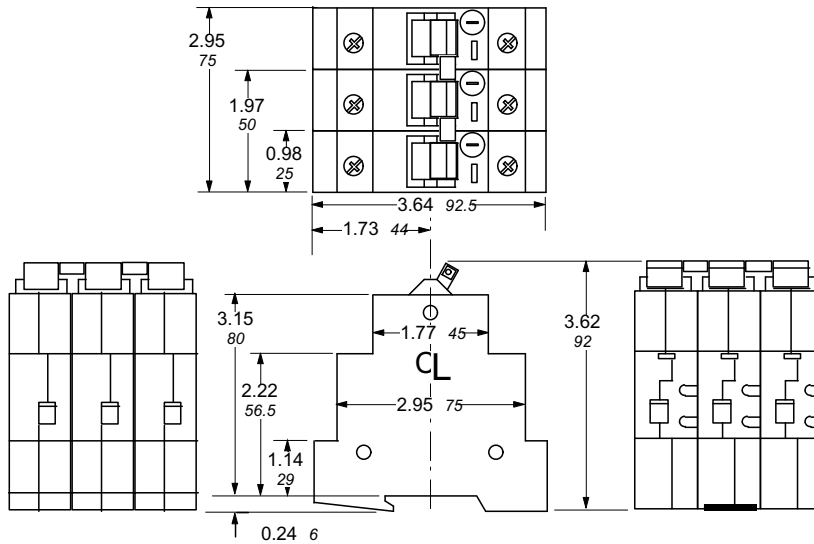

S500-RD3 Handle mechanism

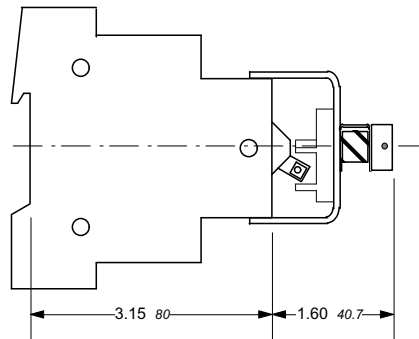

S500 Front mounting kit

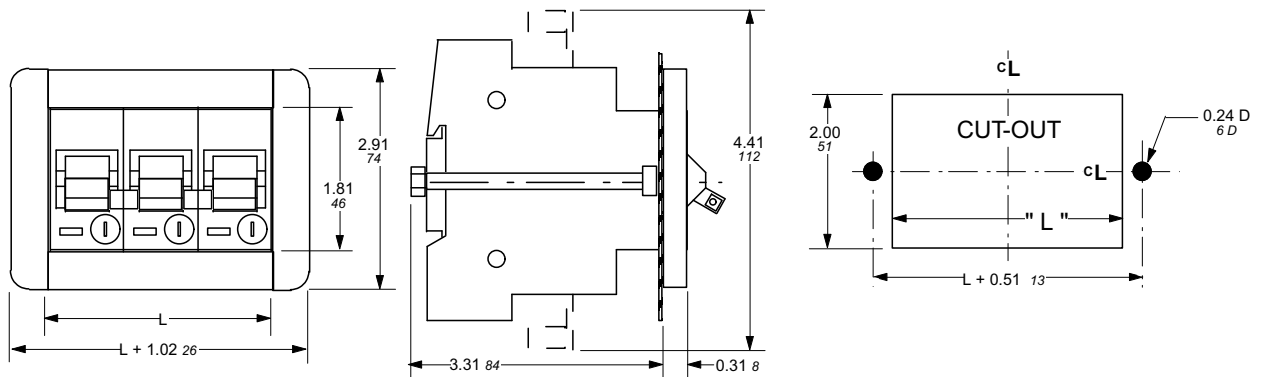

Miniature circuit breakers Technical data



Miniature circuit breakers Technical data



S201UP-K



S201-B



S801U-B



S501-K

S200

UL489

S200U-K	76
S200U-Z	76
S200UP-K	76
S200UP-Z	76
S201DC-K	77
S201DC-Z	77

UL1077

S200-B	77
S200-C, D	77
S200-K	78
S200P-K	78
S200P-Z	78
S280W-K	78
S280UC-K	79
S280UC-Z	79
S280U-Z	79
S290-C	79

S800

UL489

S800U-K	80
---------------	----

IEC

S800S-B	80
S800S-C	80
S800S-D	80
S800S-K	81

S500

UL1077

S500UC-B, K	82
S500-K	82

Technical data

S200U-K, S200U-Z, S200UP-K, S200UP-Z

Item	S200U-K	S200U-Z	S200UP-K	S200UP-Z
Approvals:				
UL	489	489	489	489
CSA	C22.2 No. 5	C22.2 No. 5	C22.2 No. 5	C22.2 No. 5
VDE	0660	0660	0660	0660
IEC	898, 947	898, 947	898, 947	898
Number of Poles:	1,2,3,4	1,2,3,4	1,2,3,4	1,2,3,4
Tripping Characteristic:	K	Z	K	Z
Rated Currents:	0.2 to 63A	0.2 to 63A	0.2 to 25A	0.2 to 25A
Minimum Operating Voltage:	12V	12V	12V	12V
UL/CSA Rated Voltage & Interrupting Capacity:				
Frequency:	50/60 Hz	50/60 Hz	50/60 Hz	50/60 Hz
120VAC	10kA	10kA	10kA	10kA
240 VAC	10kA	10kA	10kA	10kA
277 VAC	—	—	—	—
277/480 VAC	—	—	—	—
60VDC	—	—	—	—
125VDC	—	—	—	—
250VDC	—	—	—	—
500VDC	—	—	—	—
IEC Rated Voltage				
Frequency:	50/60 Hz	50/60 Hz	50/60 Hz	50/60 Hz
Rated Voltage				
IEC Single Pole	—	—	—	—
IEC Multi-Pole	—	—	—	—
Production Category:	IP20	IP20	IP20	IP20
Depth of Unit Per DIN 43880:	68mm/ 2.68 in.	68mm/ 2.68 in.	68mm/ 2.68 in.	68mm/ 2.68 in.
Mounting Position:	Vertical / horizontal	Vertical / horizontal	Vertical / horizontal	Vertical / horizontal
Standard Mounting:	35mm DIN rail	35mm DIN rail	35mm DIN rail	35mm DIN rail
Main and Shunt Trip Terminals:				
Wire Size	18-4 AWG/.82-21.2mm ²	18-4 AWG/.82-21.2mm ²	18-4 AWG/.82-21.2mm ²	18-4 AWG/.82-21.2mm ²
Torque	17.5 in-lbs. / 1.978 Nm	17.5 in-lbs. / 1.978 Nm	17.5 in-lbs. / 1.978 Nm	17.5 in-lbs. / 1.978 Nm
Tool	# 2 Posidrive	# 2 Posidrive	# 2 Posidrive	# 2 Posidrive
Accessory Terminals				
Wire Size	18-16 AWG/.82-1.3mm ²	18-16 AWG/.82-1.3mm ²	18-16 AWG/.82-1.3mm ²	18-16 AWG/.82-1.3mm ²
Torque	4.5 in-lbs./ .51nm	4.5 in-lbs./ .51nm	4.5 in-lbs./ .51nm	4.5 in-lbs./ .51nm
Tool	# 1 Posidrive	# 1 Posidrive	# 1 Posidrive	# 1 Posidrive
Service Life at Rated Load:	No Load 20,000 operations	No Load 20,000 operations Full Load 10,000 operations	No Load 20,000 operations Full Load 10,000 operations	No Load 20,000 operations Full Load 10,000 operations
Ambient Temperatures:				
Minimum	-25°C... -13°F	-25°C... -13°F	-25°C... -13°F	-25°C... -13°F
Maximum	70°C... 158°F	70°C... 158°F	70°C... 158°F	70°C... 158°F
Storage Temperatures:				
Minimum	-40°C... -40°F	-40°C... -40°F	-40°C... -40°F	-40°C... -40°F
Maximum	70°C... 158°F	70°C... 158°F	70°C... 158°F	70°C... 158°F
Shock Resistance:	30g minimum of 2 impacts, shock duration of 13ms	30g minimum of 2 impacts, shock duration of 13ms	30g minimum of 2 impacts, shock duration of 13ms	30g minimum of 2 impacts, shock duration of 13ms
Vibration Resistance:	5g, 20 cycles, 5 Hz, 150 Hz	5g, 20 cycles, 5 Hz, 150 Hz	5g, 20 cycles, 5 Hz, 150 Hz @ 0.8 ~ In	5g, 20 cycles, 5 Hz, 150 Hz @ 0.8 ~ In
Disconnecting Neutral Rating:	—	—	—	—

Technical data

S200DC-K, S201DC-Z, S200-B, S200-C, D

MCB
Technical data

Item	S201DC-K	S201DC-Z	S200-B	S200-C, D
Approvals:				
UL	489	489	1077	1077
CSA	C22.2 No. 5	C22.2 No. 5	C22.2 No. 235	C22.2 No. 235
VDE	0660	0660	0641, 0660	0660
IEC	—	—	898, 947	898, 947
Number of Poles:	1	1	1,2,3,4, 1+N, 3+N	1,2,3, 1+N, 3+N
Tripping Characteristic:	K	Z	B	C, D
Rated Currents:	1 to 25A	1 to 25A	6 to 63A	0.5 to 63A
Minimum Operating Voltage:	—	—	12V	12V
UL/CSA Rated Voltage & Interrupting Capacity:			Single pole Multi pole	Single pole Multi pole
Frequency:	50/60 Hz	50/60 Hz	50/60 Hz	50/60 Hz
120VAC	—	—	10 kA —	10 kA —
240 VAC	—	—	6 kA 10 kA	6 kA 10 kA
277 VAC	—	—	6 kA —	6 kA —
277/480 VAC	—	—	— 6 kA	— 6 kA
60VDC	10 kA	10 kA	10 kA 10 kA	10 kA 10 kA
125VDC	—	—	— 10 kA	— 10 kA
250VDC	—	—	— —	— —
500VDC	—	—	— —	— —
IEC Rated Voltage				
Frequency:	—	—	50/60 Hz	50/60 Hz
Rated Voltage				
IEC Single Pole	—	—	240/415 VAC, 60 VDC	240/415 VAC, 60 VDC
IEC Multi-Pole	—	—	415 VAC, 110 VDC	415 VAC, 110 VDC
Production Category:	IP20	IP20	IP20	IP20
Depth of Unit Per DIN 43880:	—	—	68mm/ 2.68 in.	68mm/ 2.68 in.
Mounting Position:	Vertical / horizontal	Vertical / horizontal	Vertical / horizontal	Vertical / horizontal
Standard Mounting:	35mm DIN rail	35mm DIN rail	35mm DIN rail	35mm DIN rail
Main and Shunt Trip Terminals:				
Wire Size	—	—	18-4 AWG/.82-21.2 mm ²	18-4 AWG/.82-21.2 mm ²
Torque	—	—	17.5 in-lbs. / 1.978 Nm	17.5 in-lbs. / 1.978 Nm
Tool	—	—	# 2 Posidrive	# 2 Posidrive
Accessory Terminals				
Wire Size	—	—	18-16 AWG/.82-1.3 mm ²	18-16 AWG/.82-1.3 mm ²
Torque	—	—	4.5 in-lbs./ .51 Nm	4.5 in-lbs./ .51 Nm
Tool	—	—	# 1 Posidrive	# 1 Posidrive
Service Life at Rated Load:	—	—	No Load 20,000 operations Full Load 10,000 operations	No Load 20,000 operations Full Load 10,000 operations
Ambient Temperatures:				
Minimum	—	—	-25°C... -13°F	-25°C... -13°F
Maximum	—	—	70°C... 158°F	70°C... 158°F
Storage Temperatures:				
Minimum	—	—	-40°C... -40°F	-40°C... -40°F
Maximum	—	—	70°C... 158°F	70°C... 158°F
Shock Resistance:	—	—	30g minimum of 2 impacts, shock duration of 13 ms	30g minimum of 2 impacts, shock duration of 13 ms
Vibration Resistance:	—	—	5g, 20 cycles, 5 Hz, 150 Hz	5g, 20 cycles, 5 Hz, 150 Hz
Disconnecting Neutral Rating:	—	—	6 kA switching	6 kA switching

Technical data

S200-K, S200P-K, S200P-Z, S280W-K

Item	S200-K		S200P-K		S200P-Z		S280W-K	
Approvals:	1077		1077		1077		1077	
UL	C22.2 No. 235		—		—		C22.2 No. 235	
CSA	0660		0660		0660		0660	
VDE	898, 947		898, 947		898, 947		—	
IEC	1,2,3,4, 1+N, 3+N		1,2,3,4, 1+N, 3+N		1,2,3,4		1,2,3	
Number of Poles:	K		K		Z		K	
Tripping Characteristic:	0.5 to 63A		0.2 to 63A		0.5 to 63A		0.2 to 63A	
Rated Currents:	12 V		12 V		12 V		12 V	
Minimum Operating Voltage:	Single pole Multi pole		Single pole Multi pole		Single pole Multi pole			
UL/CSA Rated Voltage & Interrupting Capacity:	50/60 Hz		50/60 Hz		50/60 Hz		50/60 Hz	
Frequency:	10 kA —	10 kA —	10 kA —	10 kA —	10 kA —	10 kA —	—	—
120VAC	6 kA 10 kA	10 kA 10 kA	10 kA 10 kA	10 kA 10 kA	10 kA 10 kA	10 kA 10 kA	—	—
240 VAC	6 kA —	10 kA —	10 kA —	10 kA —	10 kA —	10 kA —	—	—
277 VAC	— 6 kA	— 10 kA	— 10 kA	— 10 kA	— 10 kA	— 10 kA	—	10 kA
277/480 VAC	10 kA 10 kA	— —	— —	— —	— —	— —	—	—
60VDC	— 10 kA	— 10 kA	— —	— —	— —	— —	—	—
125VDC	— —	— —	— —	— —	— —	— —	—	—
250VDC	— —	— —	— —	— —	— —	— —	—	—
500VDC	— —	— —	— —	— —	— —	— —	—	—
IEC Rated Voltage	50/60 Hz		50/60 Hz		50/60 Hz		50/60 Hz	
Frequency:	240/415 VAC, 60 VDC		240/415 VAC, 60 VDC		—		—	
Rated Voltage	415 VAC, 110 VDC		415 VAC, 110 VDC		—		—	
IEC Single Pole								
IEC Multi-Pole								
Production Category:	IP20		IP20		IP20		IP20	
Depth of Unit Per DIN 43880:	68mm/ 2.68 in.		68mm/ 2.68 in.		68mm/ 2.68 in.		68mm/ 2.68 in.	
Mounting Position:	Vertical / horizontal		Vertical / horizontal		Vertical / horizontal		Vertical / horizontal	
Standard Mounting:	35mm DIN rail		35mm DIN rail		35mm DIN rail		35mm DIN rail	
Main and Shunt Trip Terminals:	18-4 AWG/.82-21.2 mm ²		18-4 AWG/.82-21.2 mm ²		18-4 AWG/.82-21.2 mm ²		18-4 AWG/.82-21.2 mm ²	
Wire Size	17.5 in.-lbs. / 1.978 Nm		17.5 in.-lbs. / 1.978 Nm		17.5 in.-lbs. / 1.978 Nm		17.5 in.-lbs. / 1.978 Nm	
Torque	# 2 Posidrive		# 2 Posidrive		# 2 Posidrive		# 2 Posidrive	
Tool								
Accessory Terminals	18-16 AWG/.82-1.3 mm ²		18-16 AWG/.82-1.3 mm ²		18-16 AWG/.82-1.3 mm ²		18-16 AWG/.82-1.3 mm ²	
Wire Size	4.5 in.-lbs./ .51 Nm		4.5 in.-lbs./ .51 Nm		4.5 in.-lbs./ .51 Nm		4.5 in.-lbs./ .51 Nm	
Torque	# 1 Posidrive		# 1 Posidrive		# 1 Posidrive		# 1 Posidrive	
Tool								
Service Life at Rated Load:	No Load 20,000 operations Full Load 10,000 operations		No Load 20,000 operations Full Load 10,000 operations		No Load 20,000 operations Full Load 10,000 operations		No Load 20,000 operations Full Load 10,000 operations	
Ambient Temperatures:	-25°C... -13°F		-25°C... -13°F		-25°C... -13°F		-25°C... -13°F	
Minimum	70°C... 158°F		70°C... 158°F		70°C... 158°F		55°C... 131°F	
Maximum								
Storage Temperatures:	-40°C... -40°F		-40°C... -40°F		-40°C... -40°F		-40°C... -40°F	
Minimum	70°C... 158°F		70°C... 158°F		70°C... 158°F		70°C... 158°F	
Maximum								
Shock Resistance:	30g minimum of 2 impacts, shock duration of 13 ms		30g minimum of 2 impacts, shock duration of 13 ms		30g minimum of 2 impacts, shock duration of 13 ms		30g minimum of 2 impacts, shock duration of 13 ms	
Vibration Resistance:	5g, 20 cycles, 5 Hz, 150 Hz		5g, 20 cycles, 5 Hz, 150 Hz		5g, 20 cycles, 5 Hz, 150 Hz		5g, 20 cycles, 5 Hz, 150 Hz	
Disconnecting Neutral Rating:	6 kA switching		—		—		—	

Technical data

S280UC-K, S280UC-Z, S290-C, S800U-K

MCB
Technical data

Item	S280UC-K		S280UC-Z		S280U-Z	S290-C
Approvals:						
UL	1077		1077		489	489
CSA	—		—		22.2 No. 5.1	22.2
VDE	0660		0660		—	0660
IEC	898, 947		898, 947		—	—
Number of Poles:	1,2,3		1,2,3		1,2,3,4	1
Tripping Characteristic:	K		Z		Z	Z
Rated Currents:	0.2 to 63A		0.5 to 63A		10 to 100A	1 to 25A
Minimum Operating Voltage:	12 V		12 V		—	—
UL/CSA Rated Voltage & Interrupting Capacity:	Single pole	Multi pole	Single pole	Multi pole		
Frequency:	50/60 Hz		50/60 Hz		50/60 Hz	—
120VAC	10 kA	10 kA	10 kA	—	—	—
240 VAC	10 kA	6 kA	10 kA	10 kA	50 kA	—
277 VAC	10 kA	6 kA	10 kA	—	—	—
277/480 VAC	—	4.5 kA for 0.2-40 A 5 kA for 50-63 A	—	4.5 kA for 0.2-40 A 5 kA for 50-63 A	—	—
60VDC	10 kA	10 kA	10 kA	10 kA	—	—
125VDC	10 kA	—	10 kA	10 kA	—	—
250VDC	4.5 kA	4.5 kA	4.5 kA	4.5 kA	—	—
500VDC	—	4.5 kA	—	4.5 kA	—	—
IEC Rated Voltage						
Frequency:	50/60 Hz		50/60 Hz		—	50/60 Hz
Rated Voltage						
IEC Single Pole	—		—		—	230/440 VAC, 60 VDC
IEC Multi-Pole	—		—		—	440 VAC, 110 VDC
Production Category:	IP20		IP20		IP20	IP20
Depth of Unit Per DIN 43880:	68mm/ 2.68 in.		68mm/ 2.68 in.		—	—
Mounting Position:	Vertical / horizontal		Vertical / horizontal		Vertical / horizontal	Vertical / horizontal
Standard Mounting:	35mm DIN rail		35mm DIN rail		35mm DIN rail	35mm DIN rail
Main and Shunt Trip Terminals:						
Wire Size	18-4 AWG/.82-21.2 mm ² for 0.2 - 40A 18-2 AWG for 50 A & above 17.5 in.-lbs. / 1.978 Nm # 2 Posidrive		18-4 AWG/.82-21.2 mm ² for 0.5 - 40A 18-2 AWG for 50 A & above 17.5 in.-lbs. / 1.978 Nm # 2 Posidrive		1... 25	14-1 AWG
Torque					35 in.-lbs. / 4 Nm	4.5 in.-lbs. # 1 Posidrive
Tool					—	
Accessory Terminals						
Wire Size	18-16 AWG/.82-1.3 mm ²		18-16 AWG/.82-1.3 mm ²		1... 35	18-16 AWG/.82-1.3 mm ²
Torque	4.5 in.-lbs./ .51 Nm		4.5 in.-lbs./ .51 Nm		35 in.-lbs./4 Nm	4.5 in.-lbs./ .51 Nm
Tool	# 1 Posidrive		# 1 Posidrive		—	# 1 Posidrive
Service Life at Rated Load:	No Load 20,000 operations Full Load 10,000 operations		No Load 20,000 operations Full Load 10,000 operations		6,000 operations	10,000 operations
Ambient Temperatures:						
Minimum	-25°C... -13°F		-25°C... -13°F		-25°C... -13°F	-23°C... -23°F
Maximum	55°C... 131°F		55°C... 131°F		60°C... 140°F	45°C... 113°F
Storage Temperatures:						
Minimum	-40°C... -40°F		-40°C... -40°F		-40°C... -40°F	-40°C... -40°F
Maximum	70°C... 158°F		70°C... 158°F		70°C... 158°F	70°C... 158°F
Shock Resistance:	30g minimum of 2 impacts, shock duration of 13 ms		30g minimum of 2 impacts, shock duration of 13 ms		—	30g minimum of 2 impacts, shock duration of 13 ms
Vibration Resistance:	5g, 20 cycles, 5 Hz, 150 Hz		5g, 20 cycles, 5 Hz, 150 Hz		—	60 ms @ 10-150 Hz
Disconnecting Neutral Rating:	—		—		—	—

Technical data

S280U-Z, S800S-B, S800S-C, S800S-D

Item	S800U-K, Z	S800S-B	S800S-C	S800S-D
Approvals:				
UL	489	—	—	—
CSA	22.2 No. 5.1	—	—	—
VDE	—	—	—	—
IEC	—	60947-2	60947-2	60947-2
Number of Poles:	1,2,3,4	1,2,3,4	1,2,3,4	1,2,3,4
Tripping Characteristic:	K	B	C	D
Rated Currents:	10 to 100A	10 to 125A	10 to 125A	10 to 125A
Minimum Operating Voltage:	—	—	—	—
UL/CSA Rated Voltage & Interrupting Capacity:				
Frequency:	50/60 Hz	—	—	—
120VAC	—	—	—	—
240 VAC	50 kA	—	—	—
277 VAC	—	—	—	—
277/480 VAC	—	—	—	—
60VDC	—	—	—	—
125VDC	—	—	—	—
250VDC	—	—	—	—
500VDC	—	—	—	—
IEC Rated Voltage Frequency:	—	50/60 Hz	50/60 Hz	50/60 Hz
Rated Voltage	—	690 VAC	690 VAC	690 VAC
IEC Single Pole	—	—	—	—
IEC Multi-Pole	—	—	—	—
Production Category:	IP20	IP20	IP20	IP20
Depth of Unit Per DIN 43880:	—	—	—	—
Mounting Position:	Vertical / horizontal	Vertical / horizontal	Vertical / horizontal	Vertical / horizontal
Standard Mounting:	35mm DIN rail	35mm DIN rail	35mm DIN rail	35mm DIN rail
Main and Shunt Trip Terminals:				
Wire Size	1... 25	1... 25	1... 25	1... 25
Torque	35 in-lbs. / 4 Nm	35 in-lbs. / 4 Nm	35 in-lbs. / 4 Nm	35 in-lbs. / 4 Nm
Tool	—	—	—	—
Accessory Terminals				
Wire Size	1... 35	1... 35	1... 35	1... 35
Torque	35 in-lbs./4 Nm	35 in-lbs./4 Nm	35 in-lbs./4 Nm	35 in-lbs./4 Nm
Tool	—	—	—	—
Service Life at Rated Load:	6,000 operations	6,000 operations	6,000 operations	6,000 operations
Ambient Temperatures:				
Minimum	-25°C... -13°F	-25°C... -13°F	-25°C... -13°F	-25°C... -13°F
Maximum	60°C... 140°F	60°C... 140°F	60°C... 140°F	60°C... 140°F
Storage Temperatures:				
Minimum	-40°C... -40°F	-40°C... -40°F	-40°C... -40°F	-40°C... -40°F
Maximum	70°C... 158°F	70°C... 158°F	70°C... 158°F	70°C... 158°F
Shock Resistance:	—	—	—	—
Vibration Resistance:	—	—	—	—
Disconnecting Neutral Rating:	—	—	—	—

Technical data

S800S-K

Item	S800S-K
Approvals:	
UL	—
CSA	—
VDE	—
IEC	60947-2
Number of Poles:	1,2,3,4
Tripping Characteristic:	K
Rated Currents:	10 to 125A
Minimum Operating Voltage:	—
UL/CSA Rated Voltage & Interrupting Capacity:	
Frequency:	—
120VAC	—
240 VAC	—
277 VAC	—
277/480 VAC	—
60VDC	—
125VDC	—
250VDC	—
500VDC	—
IEC Rated Voltage Frequency:	50/60 Hz
Rated Voltage	
IEC Single Pole	690 VAC
IEC Multi-Pole	—
Production Category:	IP20
Depth of Unit Per DIN 43880:	—
Mounting Position:	Vertical / horizontal
Standard Mounting:	35mm DIN rail
Main and Shunt Trip Terminals:	
Wire Size	1... 25
Torque	35 in-lbs. / 4 Nm
Tool	—
Accessory Terminals	
Wire Size	1... 35
Torque	35 in-lbs./4 Nm
Tool	—
Service Life at Rated Load:	6,000 operations
Ambient Temperatures:	
Minimum	-25°C... -13°F
Maximum	60°C... 140°F
Storage Temperatures:	
Minimum	-40°C... -40°F
Maximum	70°C... 158°F
Shock Resistance:	—
Vibration Resistance:	—
Disconnecting Neutral Rating:	—

Technical data

S500-K, Z; S500UC-B, K

Item	S500-K, Z
Approvals: UL CSA VDE IEC	1077 C22.2 - No. 235 0641/6.78 —
No. of poles:	1,2,3, +N, +NA
Tripping characteristic:	K
Rated currents:	0.1 to 45A
Rated voltage: UL/CSA single pole UL/CSA multi pole IEC single pole	277VAC 600YVAC 690VAC
Rated interrupting capacity: Single pole	0.15-25A – 30KA/240VAC 14KA/277VAC 26-45A – 18KA/240VAC 14KA/277VAC
Multi-pole	0.15-45A – 14KA/480VAC 6KA/600VAC
Frequency:	50/60Hz
Mounting position:	Vertical / horizontal
Standard mounting:	35 _{mm} DIN rail
Terminals:	Conductors from 16-4AWG
Service life at rated load:	20,000 operations
Calibration temperature:	40°C

Item	S500UC-B, K																																								
Approvals: UL CSA VDE	1077 C22.2 0660																																								
No. of poles:	1,2,3, 4																																								
Tripping characteristic:	B, K																																								
Rated currents:	B: 6 to 63A K: 0.15 to 45A																																								
Rated voltage: UL single pole UL multi pole IEC multi pole	277VAC/250VDC 600VAC/600VDC 690VAC/750VDC																																								
Rated interrupting capacity:	<table border="0"> <tr> <td>B single pole:</td> <td>6 – 25A</td> <td>18KA/240VAC</td> <td>14KA/277VAC</td> <td>30KA/250VDC</td> </tr> <tr> <td></td> <td>32 – 63A</td> <td>30KA/240VAC</td> <td>14KA/277VAC</td> <td>30KA/250VDC</td> </tr> <tr> <td>B two-pole:</td> <td>6 – 63A</td> <td>14KA/480VAC</td> <td>6KA/600VAC</td> <td>30KA/500VDC</td> </tr> <tr> <td>B three-pole:</td> <td>6 – 63A</td> <td>14KA/480VAC</td> <td>6KA/600VAC</td> <td>30KA/600VDC</td> </tr> <tr> <td>K single pole:</td> <td>0.15 – 25A</td> <td>30KA/240VAC</td> <td>14KA/277VAC</td> <td>30KA/250VDC</td> </tr> <tr> <td></td> <td>32 – 45A</td> <td>18KA/240VAC</td> <td>14KA/277VAC</td> <td>30KA/250VDC</td> </tr> <tr> <td>K two-pole:</td> <td>0.15 – 45A</td> <td>14KA/480VAC</td> <td>6KA/600VAC</td> <td>30KA/500VDC</td> </tr> <tr> <td>K three-pole:</td> <td>0.5 – 45A</td> <td>14KA/480VAC</td> <td>6KA/600VAC</td> <td>30KA/600VDC</td> </tr> </table>	B single pole:	6 – 25A	18KA/240VAC	14KA/277VAC	30KA/250VDC		32 – 63A	30KA/240VAC	14KA/277VAC	30KA/250VDC	B two-pole:	6 – 63A	14KA/480VAC	6KA/600VAC	30KA/500VDC	B three-pole:	6 – 63A	14KA/480VAC	6KA/600VAC	30KA/600VDC	K single pole:	0.15 – 25A	30KA/240VAC	14KA/277VAC	30KA/250VDC		32 – 45A	18KA/240VAC	14KA/277VAC	30KA/250VDC	K two-pole:	0.15 – 45A	14KA/480VAC	6KA/600VAC	30KA/500VDC	K three-pole:	0.5 – 45A	14KA/480VAC	6KA/600VAC	30KA/600VDC
B single pole:	6 – 25A	18KA/240VAC	14KA/277VAC	30KA/250VDC																																					
	32 – 63A	30KA/240VAC	14KA/277VAC	30KA/250VDC																																					
B two-pole:	6 – 63A	14KA/480VAC	6KA/600VAC	30KA/500VDC																																					
B three-pole:	6 – 63A	14KA/480VAC	6KA/600VAC	30KA/600VDC																																					
K single pole:	0.15 – 25A	30KA/240VAC	14KA/277VAC	30KA/250VDC																																					
	32 – 45A	18KA/240VAC	14KA/277VAC	30KA/250VDC																																					
K two-pole:	0.15 – 45A	14KA/480VAC	6KA/600VAC	30KA/500VDC																																					
K three-pole:	0.5 – 45A	14KA/480VAC	6KA/600VAC	30KA/600VDC																																					
Frequency:	50/60Hz																																								
Mounting position:	Vertical / horizontal																																								
Standard mounting:	35 _{mm} DIN-rail																																								
Terminals:	Conductors from 16 to 4AWG (1-25sq mm)																																								
Service life at rated load:	20,000 operations																																								

F200 Series Residual Current Devices



Residual current devices

F200 Series

UL 1053



Description

The F200 Series residual current devices offer a wide range of product for all of your fault protection needs.

A & AC

A large offering for standard instantaneous and selective AC and A types.

All sizes up to 63 mA with sensitivity thresholds up to 1 A are offered in all possible pole configurations.

ABB RCDs carry many marks and approvals for the worldwide market.

Features

RCDs assure protection to equipment against current leakage to earth.

	F200A	F200AC
Type	AC	A
Amperage	16, 25, 40, 63, 80, 100, 125	16, 25, 40, 63, 80, 100, 126
Voltage	480Y/277 VAC	480Y/277 VAC
Sensitivity	0.01-0.03 / 0.1-0.3-0.5	0.01-0.03 / 0.1-0.3-0.6

F200AC

F200 Series

AC Type

AC



F202AC



F204AC

No. of poles	Rated residual current mA	Rated current A	Catalog number
2	10	16	F202AC-16/0.01
		25	F202AC-25/0.03
	30	40	F202AC-40/0.03
		63	F202AC-63/0.03
		80	F202AC-80/0.03
		100	F202AC-100/0.03
		100	F202AC-100/0.03
	100	25	F202AC-25/0.1
		40	F202AC-40/0.1
		63	F202AC-63/0.1
		80	F202AC-80/0.1
		100	F202AC-100/0.1
	300	25	F202AC-25/0.3
		40	F202AC-40/0.3
		63	F202AC-63/0.3
100		F202AC-100/0.3	
500	25	F202AC-25/0.5	
	40	F202AC-40/0.5	
	63	F202AC-63/0.5	
	100	F202AC-100/0.5	

No. of poles	Rated residual current mA	Rated current A	Catalog number
4	30	25	F204AC-25/0.03
		40	F204AC-40/0.03
		63	F204AC-63/0.03
		80	F204AC-80/0.03
		100	F204AC-100/0.03
		125	F204AC-125/0.03
	100	25	F204AC-25/0.1
		40	F204AC-40/0.1
		63	F204AC-63/0.1
		80	F204AC-80/0.1
		100	F204AC-100/0.1
	300	25	F204AC-25/0.3
		40	F204AC-40/0.3
		63	F204AC-63/0.3
		100	F204AC-100/0.3
500	25	F204AC-25/0.5	
	40	F204AC-40/0.5	
	63	F204AC-63/0.5	
	80	F204AC-80/0.5	
	125	F204AC-125/0.5	

Type AC

- Suitable for alternating current
- 2 & 4 poles
- 16-100 A range
- Can be used as a main device providing ground fault protection against earth leakage for several MCB branch devices

Technical data

Technical data – See page 15.90

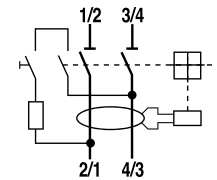

F202AC

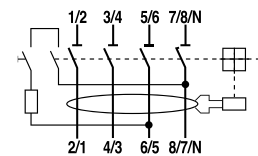

F204AC

F200A

F200 Series

A Type

A



F202A



F204A

No. of poles	Rated residual current mA	Rated current A	Catalog number	
2	10	16	F202A-16/0.01	
		30	25	F202A-25/0.03
			40	F202A-40/0.03
	63		F202A-63/0.03	
	80		F202A-80/0.03	
	100		F202A-100/0.03	
	100		25	F202A-25/0.1
		40	F202A-40/0.1	
		63	F202A-63/0.1	
		80	F202A-80/0.1	
		100	F202A-100/0.1	
		300	25	F202A-25/0.3
	40		F202A-40/0.3	
	63		F202A-63/0.3	
	80		F202A-80/0.3	
	100		F202A-100/0.3	
	500		25	F202A-25/0.5
		40	F202A-40/0.5	
63		F202A-63/0.5		
80		F202A-80/0.5		
100		F202A-100/0.5		

No. of poles	Rated residual current mA	Rated current A	Catalog number
4	30	25	F204A-25/0.03
		40	F204A-40/0.03
		63	F204A-63/0.03
		80	F204A-80/0.03
		100	F204A-100/0.03
		125	F204A-125/0.03
	100	25	F204A-25/0.1
		40	F204A-40/0.1
		63	F204A-63/0.1
		80	F204A-80/0.1
		100	F204A-100/0.1
		125	F204A-125/0.1
	300	25	F204A-25/0.3
		40	F204A-40/0.3
		63	F204A-63/0.3
		80	F204A-80/0.3
		100	F204A-100/0.3
		125	F204A-125/0.3
	500	25	F204A-25/0.5
		40	F204A-40/0.5
		63	F204A-63/0.5
		80	F204A-80/0.5
		100	F204A-100/0.5
		125	F204A-125/0.5

Type A

- Suitable for alternating and pulsating current
- 2 & 4 poles
- 16-100 A range
- Can be used as a main device providing ground fault protection against earth leakage for several MCB branch devices

Technical data

Technical data – See page 15.90

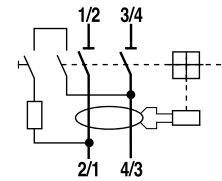

F202A

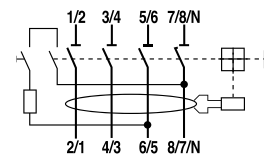

F204A

Technical data

Functions and classification criteria

RCDs

Power loss of RCDs

RCCBs F200 series

Rated Current in [A]	Power loss [W]	
	2P	4P
16	1.5	-
25	2.0	4.8
40	4.8	8.4
63	7.2	13.2

Performance in altitude of RCDs

Up to the height of 2000 m, ABB RCDs do not undergo any alterations in their rated performances. Over this height the properties of the atmosphere change in terms of composition, dielectric capacity, cooling capacity and pressure, therefore the performances of the RCDs undergo derating, which can basically be measured in terms of variations in significant parameters, such as the maximum operating voltage and the rated current.

F200

Altitude [m]	2000	3000	4000
Rated service voltage U_e [V]	400	380	380
Rated current in	I_n	$0.96 \times I_n$	$0.93 \times I_n$

Introduction

Residual current devices (RCD) have always played an important role in circuit protection by detecting leakage to ground for equipment in many installations. RCD's are used in unison with a circuit protective device in industrial applications in the United States. The following guide will give an insight to the construction, mechanical operation, and applications of RCD's.

RCD Definitions

Important definitions:

Earth leakage current

Current that flows between line to line or line to earth.

Residual current

The sum of the values of the electric currents in all live conductors

Fault current

Current that flows between line to line or line to earth.

Earth fault

When a conductive path is accidentally induced between a line and the earth

RCD Definition

RCD's provide ground fault protection to equipment by monitoring the leakage of current to ground. An RCD will trip when a ground fault is detected in excess of the trip rating of the device. An RCD is designed to disconnect a circuit whenever it detects that the electrical current is unbalanced between the phase conductor and the neutral conductor. An imbalance may be caused by phase leaking to ground.

Difference between type A and AC

Types of RCD's

Type AC

Must be used for protection against AC earth leakage current.



Type A

Must be used for protection against AC and pulsating DC (rectified AC) earth leakage current. The type A RCD must be installed in any circuit where the main supply is likely to be rectified. Some examples of applications where this would apply are motor speed controllers (drives) and power tools.

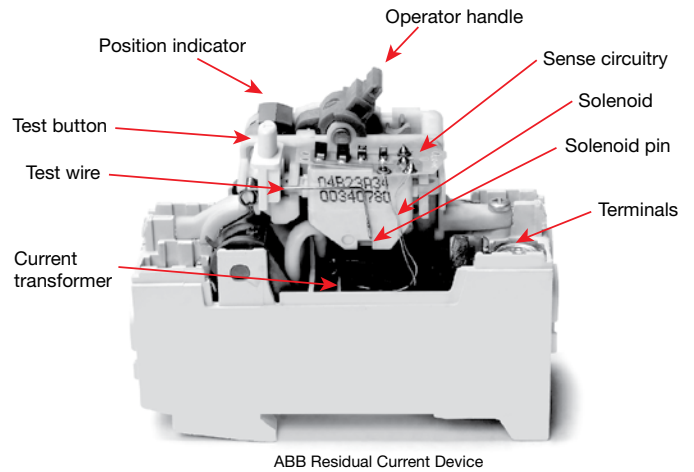
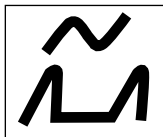

RCD Mechanical operation

Main Incoming Supply and Terminals

The main incoming and the grounded neutrals are connected to the terminals. The operator handle places the RCD in the on and off position as the position indicator shows.

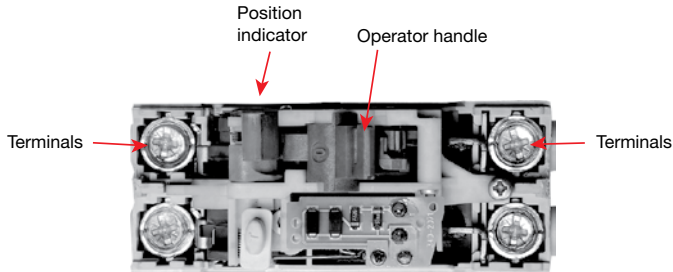

Test button and Test Wire

When the test button is pressed it allows the correct operation of the device to be verified by passing a small current through the test wire. This simulates a leakage to ground by creating an imbalance in the current transformer (CT).

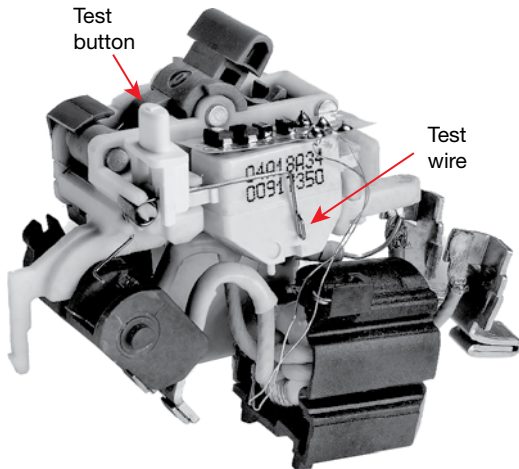

Current Transformer and Sense Circuitry

The current transformer surrounds the neutral and L1 conductors. During normal operation, all of the current being carried through the L1 conductor returns up through the neutral conductor. Therefore the currents in the two conductors are equal and opposite. When a leakage to ground occurs it causes some of the current to take a path to ground and creates an imbalance in the current between the two conductors. This imbalance in current induces a current in the current transformer (CT) which is then picked up by the sense circuitry. The sense circuitry then actuates the solenoid and the contacts are forced apart by a spring, terminating the electricity supply to the device.

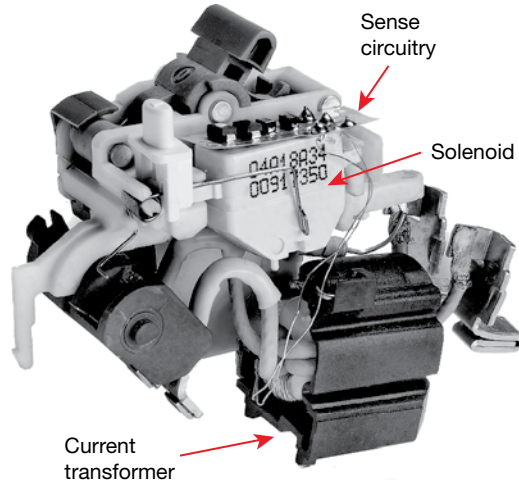

Solenoid

Once an imbalance has been detected by the CT, there is voltage induced on the CT. The voltage travels through the connected copper wires to the sense circuitry and the solenoid is actuated. The plunger at the bottom of the solenoid is then pushed out to trip the breaker.

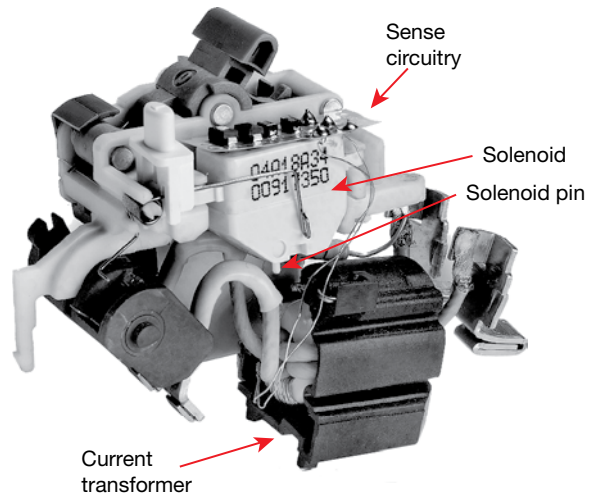

Application manual

Difference between RCD and MCB

Example of current leakage to ground

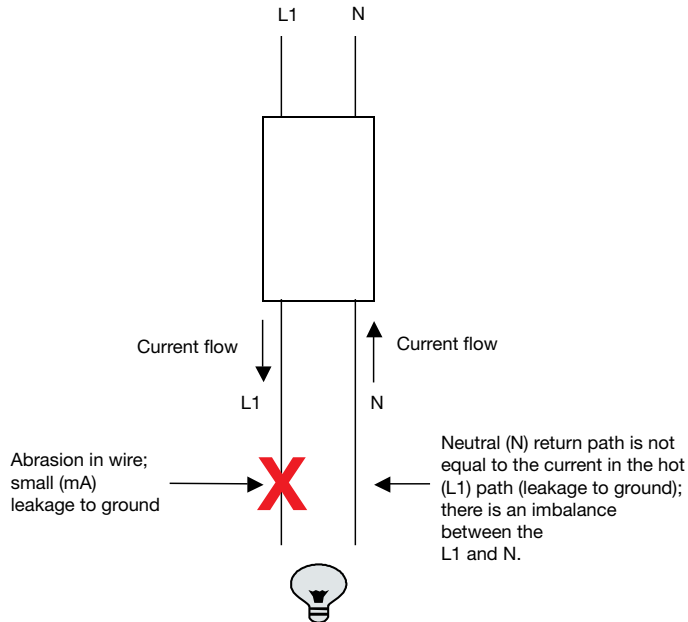

Difference between RCD and MCB

Miniature Circuit Breaker (MCB)

A miniature circuit breaker (MCB) is a device designed to isolate a circuit during an overcurrent event without the use of a fusible element. A breaker is a resettable protective device that protects against two types of overcurrent situations; overload and short circuit.

Residual Current Device (RCD)

A residual current device (RCD) is a device designed to provide protection against voltage leakage to ground. *RCD's are sensitive to a 30-300mA. RCD's are mechanical devices that contain a CT and a solenoid.* RCD's are designed to protect equipment, not wires against overload and short circuit situations. For this reason, an RCD should always be used in conjunction with an MCB in order to provide full protection from overload and leakage to ground.

Ground Fault Interrupter (GFI)

GFI Definition (NEC): A device intended for the protection of personnel that functions to de-energize a circuit or portion thereof within an established period of time when a current to ground exceeds the values established for a Class A device.

A ground fault interrupter (GFI) is a device designed to measure the current between the hot wire and neutral wire. Like the RCD, the GFI will open the closed contacts in order to protect against damage. A GFI is sensitive to 5mA and higher and is designed to protect people, not equipment.

A GFI is an electric device that contains a printed circuit board (PCB). GFI's have a "pigtail" wire at the end that carries a signal to the PCB that tells the contacts to open when a current imbalance is detected between the two conductors.

Technical data F200AC, F200A

Item	F200AC	F200A
Approvals:		
UL	1053	1053
CSA	-	-
VDE	-	-
IEC	-	-
Number of Poles:	2,4	2,4
Rated Currents:	16,25,40,63,80,100,125	16,25,40,63,80,100,125
Operating Voltage:	480Y/277 VAC	480Y/277 VAC
Production Category:	IP20	IP20
Depth of Unit Per DIN 43880:	68mm/ 2.68 in.	68mm/ 2.68 in.
Mounting Position:	vertical, horizontal	vertical, horizontal
Standard Mounting:	35mm DIN rail	35mm DIN rail
Main and Shunt Trip Terminals:		
Wire Size	18-4 AWG/.82-21.2mm ²	18-4 AWG/.82-21.2mm ²
Torque	17.5 in-lbs./1.978 nm	17.5 in-lbs./1.978 nm
Tool	#2 Posidrive	#2 Posidrive
Accessory Terminals		
Wire Size	18-16 AWG/.82-1.3mm ²	18-16 AWG/.82-1.3mm ²
Torque	4.5 in-lbs./.51nm	4.5 in-lbs./.51nm
Tool	# 1 Posidrive	# 1 Posidrive
Service Life at Rated Load:	No Load 20,000 operations Full Load 10,000 operations	No Load 20,000 operations Full Load 10,000 operations
Shock Resistance:	30g minimum of 2 impacts, shock duration of 13ms	30g minimum of 2 impacts, shock duration of 13ms
Vibration Resistance:	5g, 20 cycles, 5 Hz, 150 Hz @ 0.8 ~ 1n	5g, 20 cycles, 5 Hz, 150 Hz

Notes





Notes

Notes





Notes

Notes





Notes



ABB Inc.
1206 Hatton Road
Wichita Falls, TX 76302
Telephone 888-385-1221; 940-397-7000
Fax 940-397-7085

USA Technical help:
888-385-1221, Option 4
8AM to 5PM, CST, Monday - Friday

Find USA Authorized Distributors
www.abb-control.com

ABB Inc.
2117 32 Avenue
Lachine, Quebec, Canada
H8T 3J1
Telephone: 800-567-0283 Atlantic & Quebec
866-222-8368 Mid-West & Pacific Region
866-460-3300 Ontario