

## BL67 electronic module

### 8 Digital Inputs, PNP, Channel Diagnostics

#### BL67-8DI-PD

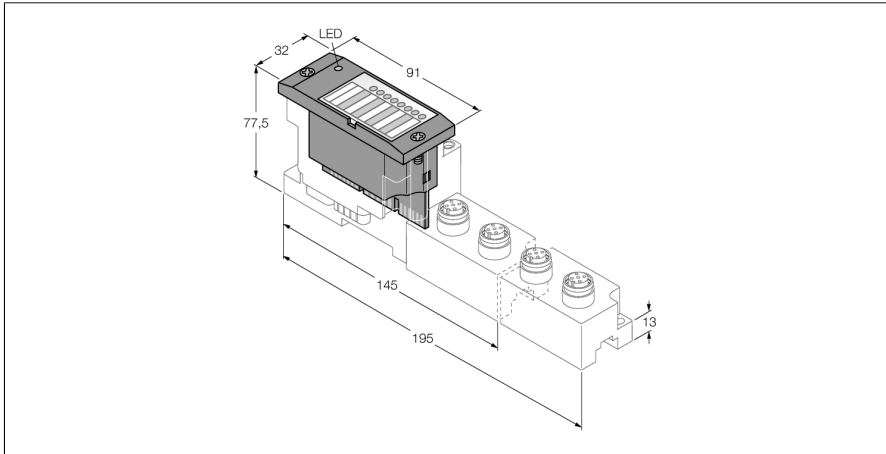

- Independent of the fieldbus and connection technology used
- Protection class IP67
- LEDs indicate status and diagnostic
- Electronics galvanically separated from the field level via optocouplers
- 8 digital inputs, 24 VDC
- PNP switching
- Channel diagnostics
- Wire-break monitoring
- Adjustable filter times
- Invertible inputs

<b>Type</b>	BL67-8DI-PD
ID	6827205
<b>Number of channels</b>	8
Supply voltage	24 VDC
Nominal voltage $V_n$	24 VDC
Nominal current from field supply	$\leq 100$ mA
Nominal current from module bus	$\leq 30$ mA
Max. sensor supply $I_{sens}$	100 mA For 2 channels ( $\Rightarrow$ e.g. per M12 slot), electronically limited current supply
Power dissipation, typical	$\leq 1.5$ W
<b>Input type</b>	PNP
Type of input diagnostics	channel diagnostics
Low level signal voltage	$< 4.5$ V
High level signal voltage	7...30 V
Low level signal current	$< 1.5$ mA
High level signal current	2.1...3.7 mA
Input delay	0.25; 2.5 ms
Electrical isolation	electronics for the field level
Output connectivity	M8, M12, M23
<b>Number of diagnostic bits</b>	12
Number of parameter bytes	8
<b>Dimensions (W x L x H)</b>	32 x 91 x 59 mm
Approvals	CE
Ambient temperature	-40...+70 °C
Temperature derating	
$< 0$ °C Ambient temperature	Support for version VN 01-03 and higher, no limitation
$> 55$ °C Steady ambient air	Simultaneity factor 0.5
Storage temperature	-40...+85 °C
Relative humidity	5...95 % (internal), level RH-2, no condensation (when stored at 45 °C)
Vibration test	Acc. to EN 61131
- up to 5 g (at 10 to 150 Hz)	for mounting on DIN rail no drilling according to EN 60715, with end bracket
- up to 20 g (at 10 up to 150 Hz)	for mounting on base plate or machinery Therefore every second module has to be mounted with two screws each.
Shock test	Acc. to IEC 60068-2-27
Drop and topple	acc. to IEC 68-2-31 and free fall to IEC 68-2-32
Electromagnetic compatibility	Acc. to EN 61131-2
Protection class	IP67
Tightening torque fixing screw	0.9...1.2 Nm

#### Functional principle

BL67 electronic modules are plugged on the purely passive base modules which in turn are connected to the field devices. The separation of connection level and electronics simplifies maintenance considerably. Flexibility is enhanced because the user can choose between base modules with different connection technologies.

The electronic modules are completely independent of the higher level fieldbus through the use of gateways.

# BL67 electronic module

## 8 Digital Inputs, PNP, Channel Diagnostics

### BL67-8DI-PD

#### Compatible base modules

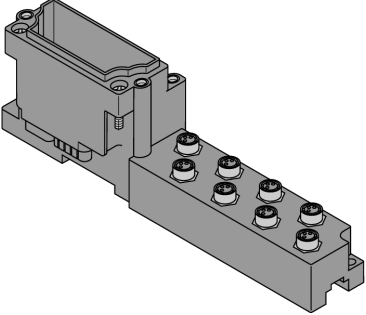
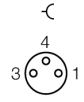
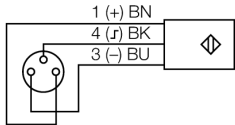
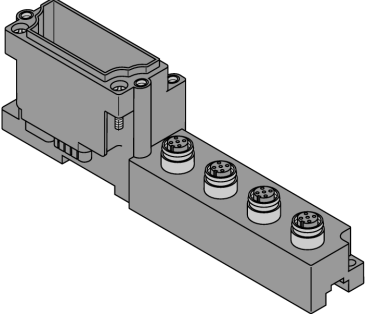
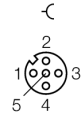
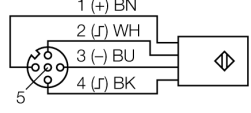
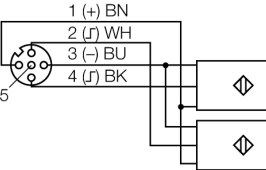
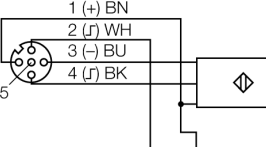
Dimension drawing	Type	Pin configuration
	<p><b>BL67-B-8M8</b> 6827188 8 x M8, 3-pole, female</p> <p><b>Comments</b> Matching connection cable (for example): PKG3M-2-PSW3M/TXL Ident-No. 6625668</p>	<p><b>Pin Assignment</b></p>  <p>1 = V<sub>SENS</sub> 3 = GND 4 = Input A</p> <p><b>Wiring Diagram</b></p> 
	<p><b>BL67-B-4M12</b> 6827187 4 x M12, 5-pole, female</p> <p><b>Comments</b> If the wire-break monitoring has been activated, on the sensor side a jumper between pin 1 (24 V DC) and pin 2 (diagnostics input) must be implemented for monitoring of wire-breaks. <b>Note</b> Wire-break monitoring only in connection with the base module BL67-B-4M12 possible!</p> <p><b>BL67-B-4M12-P</b> 6827195 4 x M12, 5-pole, female, paired</p> <p><b>Comments</b> If the wire-break monitoring has been activated, on the sensor side a jumper between pin 1 (24 V DC) and pin 2 (diagnostics input) must be implemented for monitoring of wire-breaks. <b>Note</b> Wire-break monitoring only in connection with the base module BL67-B-4M12 possible!</p>	<p><b>Pin Assignment</b></p>  <p>1 = V<sub>SENS</sub> 2 = Input B 3 = GND 4 = Input A 5 = PE</p> <p><b>Wiring Diagram</b></p>  <p><b>Wiring Diagram</b></p>  <p><b>Wiring Diagram for Wire-Break Monitoring</b></p> 

## BL67 electronic module

### 8 Digital Inputs, PNP, Channel Diagnostics

### BL67-8DI-PD

#### LED display

LED	Color	Status	Meaning
D		OFF	No error message or diagnostics active.
	RED	ON	Failure of module bus communication. Check if more than 2 adjacent electronic modules are pulled. Relevant modules are located between gateway and this module.
	RED	FLASHING (0.5 Hz)	Upcoming module diagnostics
DI channel 0...7		OFF	Status of channel x = "0" (OFF), no diagnostics active
	GREEN	ON	Status of channel x = "1" (ON)
	RED	ON	Short-circuit at output
	RED	FLASHING (2 Hz)	Short-circuit sensor supply

#### Note:

The numbering of the LEDs corresponds to the numbering of the channels.

## BL67 electronic module

### 8 Digital Inputs, PNP, Channel Diagnostics

### BL67-8DI-PD

#### Data mapping

DATA	BYTE	Bit 7	Bit 6	Bit 5	Bit 4	Bit 3	Bit 2	Bit 1	Bit 0
Input	n	DI 7	DI 6	DI 5	DI 4	DI 3	DI 2	DI 1	DI 0

n = Offset of input data; depending on extension of station and the corresponding fieldbus.

m = Offset of output data; depending on extension of station and the corresponding fieldbus.

With PROFIBUS, PROFINET and CANopen, the I/O data of this module is localized

within the process data of the whole station via the hardware configuration tool of the fieldbus master.

With DeviceNet™, EtherNet/IP™ and Modbus TCP a detailed mapping table can be created

with the TURCK configuration tool I/O-ASSISTANT.

#### Pin assignment at corresponding base module:

DATA	BYTE	Bit 7	Bit 6	Bit 5	Bit 4	Bit 3	Bit 2	Bit 1	Bit 0
------	------	-------	-------	-------	-------	-------	-------	-------	-------

<b>BL67-B-8M8</b>									
Input	n	C7 P4	C6 P4	C5 P4	C4 P4	C3 P4	C2 P4	C1 P4	C0 P4
<b>BL67-B-4M12</b>									
Input	n	C3 P2	C2 P2	C1 P2	C0 P2	C3 P4	C2 P4	C1 P4	C0 P4
<b>BL67-B-4M12-P</b>									
Input	n	C3 P2	C3 P4	C2 P2	C2 P4	C1 P2	C1 P4	C0 P2	C0 P4

C... = slot no., P... = pin no.