

General-purpose Basic Switch

Z

Best-selling Basic Switch Boasting High Precision and Wide Variety

- A large switching capacity of 15 A with high repeat accuracy.
- A wide range of variations in contact form for your selection: basic, split-contact and maintained-contact.
- A series of standard models for micro loads is available.
- A series of molded terminal-type models incorporating safety terminal protective cover is available.

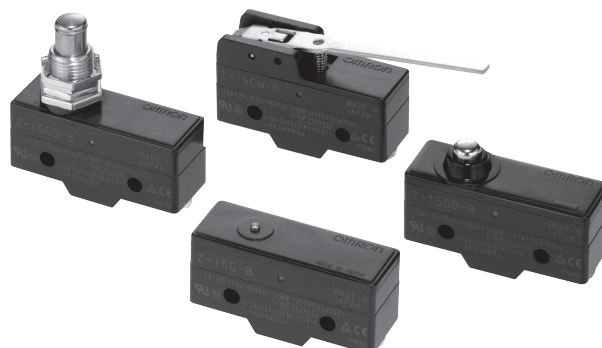

Model Number Structure

Available types

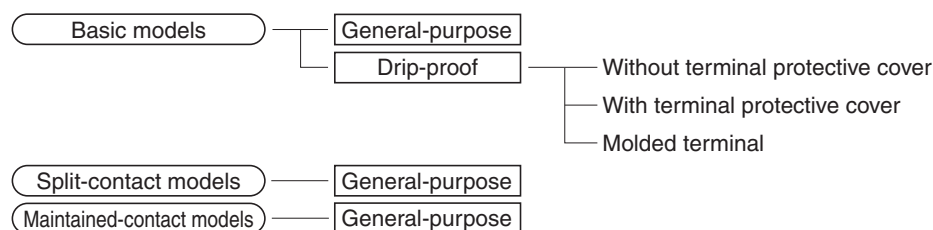

Basic Models

General-purpose

- A variety of actuators is available for a wide range of application.
- The contact mechanism of models for micro loads is a crossbar type with gold-alloy contacts, which ensures highly reliable operations for micro loads.
- Contact Gap:
 - H2: 0.20 mm (extra-high-sensitivity)
 - H: 0.25 mm (high-sensitivity, micro voltage current load)
 - G: 0.5 mm (standard)
 - E: 1.8 mm (high-capacity)
 - F: 1.0 mm (split-contact models)

Drip-proof

- These Switches use a rubber boot on the actuator and adhesive fill between the case and cover to increase resistance to drips.
- Models with drip-proof terminal protective covers and molded terminals with resin filling are also available.

Split-contact Models

- This type is identical in construction to the general-purpose basic switch except that it has two pairs of simultaneous acting contacts by splitting moving contacts.
- Since the moving contacts are connected to a common terminal, either parallel or series connection is possible.
- Highly reliable micro load switching is ensured if the model is used as a twin-contact switch.

Maintained-contact Models

- The maintained-contact type has a reset button at the bottom of the switch case, in addition to the pushbutton (plunger) located on the opposite side of the reset button. Use these buttons alternately.
- Since the Switch has greater pretravel than overtravel, it is suitable for use in reversible control circuits, manual reset circuits, safety limit circuits, and other circuits which are not preferable for automatic resetting. (For further details, refer to individual datasheets.)

■ Model Number Legend

Basic Models

Z - □ □ □ □ - □
 1 2 3 4 5

1. Ratings

01: 0.1 A (micro load)
 15: 15 A

2. Contact Gap

H2: 0.20 mm
 (extra-high sensitivity)
 H: 0.25 mm
 (high-sensitivity,
 micro load)
 G: 0.5 mm
 E: 1.8 mm (high-capacity)

3. Actuator

None: Pin plunger
 S: Slim spring plunger
 D: Short spring plunger
 K: Spring plunger (medium OP)
 K3: Spring plunger (high OP)
 Q3: Panel mount plunger (low OP)
 Q: Panel mount plunger
 (medium OP)
 Q8: Panel mount plunger (high OP)
 Q22: Panel mount roller plunger
 Q21: Panel mount cross roller plunger
 L: Leaf spring (high OF)
 L2: Roller leaf spring
 W21: Short hinge lever
 W: Hinge lever (low OF)
 W3: Hinge lever (medium OF)
 W32: Hinge lever (high OF)
 W4: Low-force hinge lever
 W44: Long hinge lever
 W78: Low-force wire
 hinge lever (low OF)
 W52: Low-force wire
 hinge lever (high OF)
 W22: Short hinge roller lever
 W2: Hinge roller lever
 W25: Hinge roller lever
 (large roller)
 W49: Short hinge
 cross roller lever
 W54: Hinge cross roller lever
 W2277: Unidirectional short hinge
 roller lever (low OF)
 M: Reverse hinge lever
 M22: Reverse short hinge roller lever
 M2: Reverse hinge roller lever
 NJ: Flexible rod (high OF)
 NJS: Flexible rod (low OF)

4. Degree of Protection

None: General-purpose
 55: Drip-proof
 A55: Drip-proof
 (including terminals)

5. Terminals

None: Solder terminal
 B: Screw terminal
 (with toothed washer)
 B5V: Screw terminal with
 terminal cover
 (for Z-15G□A55 only)

Split-contact Models

Z - 10 F □ Y - B
 1 2 3 4 5

1. Ratings

10: 10 A (split-contact models)

2. Contact Gap

F: 1 mm (high-capacity)

3. Actuator

None: Pin plunger
 S: Slim spring plunger
 D: Short spring plunger
 Q: Panel mount plunger
 Q22: Panel mount roller plunger
 W: Hinge lever
 W22: Short hinge roller lever
 W2: Hinge roller lever
 M22: Reverse short hinge roller lever

4. Construction

Y: Split-contact type

5. Terminals

None: Solder terminal
 B: Screw terminal
 (with toothed washer)

Maintained-contact models

Z - 15 E □ R
 1 2 3 4

1. Ratings

15: 15 A

2. Contact Gap

E: 1.8 mm (high-capacity)

3. Actuator

None: Pin plunger
 S: Slim spring plunger
 W: Hinge lever

4. Construction

R: Maintained-contact
 models

Drip-proof with Molded Terminal Models

Z - □ 55 - M □ □ □ M
 1 2 3 4

1. Drip-proof model

(Insert model number of basic,
 drip-proof version with solder terminals)

2. Lead Outlets

None: VSF
 E: VCT

3. Direction of Lead Outlets

L: Left
 R: Right
 D: Descending





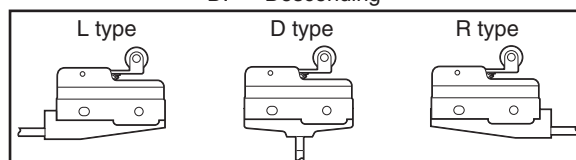



















































4. Length of Leads















1: 1 m
 3: 3 m



Ordering Information

Basic Models (General-purpose)



























Actuator	Classification	Contact gap Terminal *1	Standard	High-sensitivity	Extra-high sensitivity	High-capacity	Micro load		
			G (0.5 mm)	H (0.25 mm)	H2 (0.20 mm)	E (1.8 mm)	H (0.25 mm)		
			Model	Model	Model	Model	Model		
Pin plunger			Z-15G	Z-15H	Z-15H2	Z-15E	Z-01H		
			Z-15G-B	Z-15H-B	Z-15H2-B	Z-15E-B	Z-01H-B		
Slim spring plunger			Z-15GS	Z-15HS	---	---	Z-01HS		
			Z-15GS-B	Z-15HS-B			Z-01HS-B		
Short spring plunger			Z-15GD	Z-15HD	---	Z-15ED	Z-01HD		
			Z-15GD-B	Z-15HD-B		Z-15ED-B	Z-01HD-B		
Panel mount plunger		Low OP		Z-15GQ3	---	---	---		
				Z-15GQ3-B					
		Medium OP		Z-15GQ	Z-15HQ	---	Z-15EQ	Z-01HQ	
				Z-15GQ-B	Z-15HQ-B		Z-15EQ-B	Z-01HQ-B	
High OP		Z-15GQ8	---	---	---	---			
		Z-15GQ8-B							
Panel mount roller plunger			Z-15GQ22	Z-15HQ22	---	Z-15EQ22	---		
			Z-15GQ22-B	Z-15HQ22-B		Z-15EQ22-B			
Panel mount cross roller plunger			Z-15GQ21	Z-15HQ21	---	Z-15EQ21	---		
			Z-15GQ21-B	Z-15HQ21-B		Z-15EQ21-B			
Leaf spring			Z-15GL	---	---	---	---		
			Z-15GL-B						
Roller leaf spring			Z-15GL2	---	---	---	---		
			Z-15GL2-B						
Short hinge lever			Z-15GW21	---	---	---	---		
			Z-15GW21-B						
Hinge lever		Low OP		Z-15GW	---	---	---		
				Z-15GW-B				Z-15HW-B	
		Medium OP		Z-15GW3	---	---	---	---	
				Z-15GW3-B					
High OP		Z-15GW32	---	---	---	---			
		Z-15GW32-B							
Low-force hinge lever			Z-15GW4	Z-15HW24	---	---	---		
			Z-15GW4-B	Z-15HW24-B					
Low-force wire hinge lever		Low OP		---	---	---	---		
									Z-15HW78
		High OP							Z-15HW78-B
									Z-15HW52
Short hinge roller lever			Z-15GW22	Z-15HW22	---	Z-15EW22	Z-01HW22		
			Z-15GW22-B	Z-15HW22-B		Z-15EW22-B	Z-01HW22-B		
Short hinge cross roller lever			Z-15GW49	---	---	---	---		
			Z-15GW49-B						
Hinge roller lever		Standard		Z-15GW2	---	---	---		
				Z-15GW2-B				Z-15HW2-B	
		Large roller		Z-15GW25	---	---	---	---	
				Z-15GW25-B					

Actuator	Classification	Contact gap Terminal *1	Standard	High-sensitivity	Extra-high sensitivity	High-capacity	Micro load
			G (0.5 mm)	H (0.25 mm)	H2 (0.20 mm)	E (1.8 mm)	H (0.25 mm)
			Model	Model	Model	Model	Model
Hinge cross roller lever		 	Z-15GW54	---	---	---	---
			Z-15GW54-B				
Unidirectional short hinge roller lever	Parallel 	 	Z-15GW2277	---	---	---	---
			Z-15GW2277-B				
Reverse hinge lever *2		 	Z-15GM	---	---	---	---
			Z-15GM-B				
Reverse short hinge roller lever *2		 	Z-15GM22	---	---	---	---
			Z-15GM22-B				
Reverse hinge roller lever *2		 	Z-15GM2	---	---	---	---
			Z-15GM2-B				

*1.  : Solder terminal  : Screw terminal

*2. The pin plungers of reverse-type models are continuously pressed by the actuator levers with compression coil springs and the pin plungers are freed by operating the levers. Reverse-type models are highly vibration- and shock-resistant because the pin plungers are normally pressed.



Split-contact Models

Actuator	Contact gap Terminal *1	F (1.0 mm)
		Model
Pin plunger		 ---
		 Z-10FY-B
Slim spring plunger		 ---
		 Z-10FSY-B
Short spring plunger		 ---
		 Z-10FDY-B
Panel mount plunger		 ---
		 Z-10FQY-B
Panel mount roller plunger		 ---
		 Z-10FQ22Y-B
Hinge lever		 ---
		 Z-10FWY-B
Short hinge roller lever		 ---
		 Z-10FW22Y-B
Hinge roller lever		 ---
		 Z-10FW2Y-B
Reverse short hinge roller lever *2		 ---
		 Z-10FM22Y-B

*1.  : Solder terminal  : Screw terminal

*2. The pin plungers of reverse-type models are continuously pressed by the actuator levers with compression coil springs and the pin plungers are freed by operating the levers. Reverse-type models are highly vibration- and shock-resistant because the pin plungers are normally pressed.

Maintained-contact Models

Actuator	Model
Pin plunger 	Z-15ER
Slim spring plunger 	Z-15ESR
Hinge lever 	Z-15EWR

Drip-proof Models

Actuator	Classification Contact gap Drip-proof terminal protective cover Terminal *1	Standard G (0.5 mm)		High-sensitivity H (0.25 mm)	Micro load H (0.25 mm)
		Not provided	Provided	Not provided	Not provided
		Model	Model	Model	Model
Pin plunger			Z-15G55	---	Z-01H55
			Z-15G55-B	Z-15GA55-B5V	Z-01H55-B
Short spring plunger			Z-15GD55	---	Z-01HD55
			Z-15GD55-B		Z-01HD55-B
Spring plunger		Low OP		Z-15GK55	---
				Z-15GK55-B	
		High OP		Z-15GK355	---
				Z-15GK355-B	
Panel mount plunger			Z-15GQ55	---	---
			Z-15GQ55-B	Z-15GQA55-B5V	
Panel mount roller plunger			Z-15GQ2255	---	---
			Z-15GQ2255-B	Z-15GQ22A55-B5V	
Panel mount cross roller plunger			---	---	---
			Z-15GQ2155-B	Z-15GQ21A55-B5V	
Leaf spring			Z-15GL55	---	---
			Z-15GL55-B		
Roller leaf spring			Z-15GL255	---	---
			Z-15GL255-B		
Short hinge lever			Z-15GW2155	---	---
			Z-15GW2155-B		
Long hinge lever			Z-15GW4455	---	---
			Z-15GW4455-B		
Hinge lever			Z-15GW55	---	---
			Z-15GW55-B	Z-15GWA55-B5V	
Short hinge roller lever			Z-15GW2255	---	Z-01HW2255
			Z-15GW2255-B	Z-15GW22A55-B5V	Z-01HW2255-B
Hinge roller lever			Z-15GW255	---	---
			Z-15GW255-B	Z-15GW2A55-B5V	
Unidirectional short hinge roller lever			Z-15GW227755	---	---
			Z-15GW227755-B	Z-15GW2277A55-B5V	
Reverse hinge lever *2			Z-15GM55	---	---
			Z-15GM55-B		
Reverse short hinge roller lever *2			Z-15GM2255	---	---
			Z-15GM2255-B		
Reverse hinge roller lever *2			Z-15GM255	---	---
			Z-15GM255-B		
Flexible rod (coil spring) *3			Z-15GNJ55	---	---
			Z-15GNJ55-B		
Flexible rod (steel wire)			---	---	Z-15HNJS55
			---	---	Z-15HNJS55-B

*1.  : Solder terminal  : Screw terminal

*2. The pin plungers of reverse-type models are continuously pressed by the actuator levers with compression coil springs and the pin plungers are freed by operating the levers.

*3. The tip is made of resin.

Specifications

Characteristics

Classification		Z-15 (except micro load and flexible rod)	Z-01H	Z-15 (flexible rod)	Z-10F	Z-15H2
Operating speed		0.01 mm to 1 m/s (*1)		1 mm to 1 m/s	0.1 mm to 1 m/s (*1)	0.01 mm to 1 m/s
Operating frequency	Mechanical	240 operations/min		120 operations/min	240 operations/min	240 operations/min
	Electrical	20 operations/min				
Contact resistance		15 mΩ max. (initial value)	50 mΩ max. (initial value)	15 mΩ max. (initial value)	25 mΩ max. (initial value)	15 mΩ max. (initial value)
Insulation resistance		100 MΩ min. (at 500 VDC)				
Dielectric strength (50 / 60 Hz for 1 min.)		Between contacts of same polarity Contact gap G: 1,000 VAC Contact gap H: 600 VAC Contact gap E: 1,500 VAC		Between contacts of same polarity Contact gap G: 1,000 VAC Contact gap H: 600 VAC	Between contacts of same polarity Contact gap F: 1,500 VAC	Between contacts of same polarity 600VAC
		Between current-carrying metal parts and ground, and between each terminal and non-current-carrying metal parts: 2,000 VAC				
Vibration resistance	Malfunction	10 to 55 Hz, 1.5-mm double amplitude (*5)		10 to 20 Hz, 1.5-mm double amplitude (*5)	10 to 55 Hz, 1.5-mm double amplitude (*5)	
Shock resistance	Destruction	1,000 m/s ² max.				
	Malfunction	300 m/s ² max. (*2, *5)		50 m/s ² max. (*5)	300 m/s ² max. (*3, *5)	100 m/s ² max.
Degree of protection	General-purpose	IP00				
	Drip-proof	Equivalent to IP62 (except terminals)				
Degree of protection against electric shock		Class I				
Proof tracking index (PTI)		175				
Ambient operating temperature	General-purpose	-25°C to 80°C (with no icing)				
	Drip-proof	-15°C to 80°C (with no icing)				
Ambient operating humidity	General-purpose	35% to 85%RH				
	Drip-proof	35% to 95%RH				
Service life	Mechanical	Contact gap H2: 10,000,000 operations min. Contact gap G, H: 20,000,000 operations min. (*4) Contact gap E: 300,000 operations		1,000,000 operations min.	500,000 operations min. (*1)	20,000,000 operations min.
	Electrical	Contact gap G, H: 500,000 operations min. Contact gap E: 100,000 operations min.		100,000 operations min.	100,000 operations min.	500,000 operations min.
Weight		Approx. 22 to 58 g		Approx. 42 to 48 g	Approx. 34 to 61 g	Approx. 22 g

*1 The values are for the plunger models. (For the lever models, the values are at the plunger section.)

*2 The values are for the Z-15G pin plunger.

*3 The values are for the Z-10FY-B.

*4 The values are for the pin plunger. The service life for models other than the pin plunger is 10,000,000 min.

*5 Malfunction: 1 ms max.

Ratings (Basic, Split-contact and Maintained contact Models)

Z-15 (Except Micro Load and Flexible Rod Models)

Item		Non-inductive load (A)				Inductive load (A)			
		Resistive load		Lamp load		Inductive load		Motor load	
		NC	NO	NC	NO	NC	NO	NC	NO
Contact gap	Rated voltage								
	G, H, H2, E	15 (10) *	3	1.5	15 (10) *	5	2.5		
		15 (10) *	2.5	1.25	15 (10) *	3	1.5		
G	125 VAC	10	1.5	0.75	6	1.5	0.75		
	250 VAC								
	500 VAC *								
	8 VDC	15	3	1.5	15	5	2.5		
	14 VDC	15	3	1.5	10	5	2.5		
H, H2	30 VDC	6	3	1.5	5	5	2.5		
	125 VDC	0.5	0.5	0.5	0.05	0.05	0.05		
	250 VDC	0.25	0.25	0.25	0.03	0.03	0.03		
E	8 VDC	15	3	1.5	15	5	2.5		
	14 VDC	15	3	1.5	10	5	2.5		
	30 VDC	2	2	1.4	1	1	1		
	125 VDC	0.4	0.4	0.4	0.03	0.03	0.03		
	250 VDC	0.2	0.2	0.2	0.02	0.02	0.02		
E	8 VDC	15	3	1.5	15	5	2.5		
	14 VDC	15	3	1.5	15	5	2.5		
	30 VDC	15	3	1.5	10	5	2.5		
	125 VDC	0.75	0.75	0.75	0.4	0.4	0.4		
	250 VDC	0.3	0.3	0.3	0.2	0.2	0.2		

* Figures in parentheses are for the Z-15HW52, Z-15HW78(-B) and Z-15H2(-B) models, the AC ratings of these models are 125 and 250 V only.

Z-15 (Flexible Rod Models)

Rated voltage	Non-inductive load (A)				Inductive load (A)			
	Resistive load		Lamp load		Inductive load		Motor load	
	NC	NO	NC	NO	NC	NO	NC	NO
125 VAC	15		2	1	7		2.5	2
250 VAC	15		1	0.5	5		1.5	1
8 VDC	15		2	1	7		3	1.5
14 VDC	15		2	1	7		3	1.5
30 VDC	2		2	1	1		1	0.5
125 VDC	0.4		0.4	0.4	0.03		0.03	0.03
250 VDC	0.2		0.2	0.2	0.02		0.02	0.02

Z-10F

Contact gap	Rated voltage	Item	Non-inductive load (A)				Inductive load (A)			
			Resistive load		Lamp load		Inductive load		Motor load	
			NC	NO	NC	NO	NC	NO	NC	NO
Series connection	125 VAC		10		4	2	6		5	2.5
	250 VAC		10		2.5	1.5	6		3	1.5
	30 VDC		10		4	2	6		6	3
	125 VDC		1		1	1	0.1		0.1	0.1
Parallel connection	250 VDC		0.6		0.6	0.6	0.05		0.05	0.05
	125 VAC		6		3	1.5	4		4	2
	250 VAC		6		2.5	1.25	4		2	1
	30 VDC		6		4	2	4		6	3
	125 VDC		0.6		0.6	0.6	0.1		0.1	0.1
	250 VDC		0.3		0.3	0.3	0.05		0.05	0.05

Z-01H

Rated voltage	Resistive load (A)	
	NC	NO
125 VAC	0.1	
8 VDC	0.1	
14 VDC	0.1	
30 VDC	0.1	

Applicable Load Range

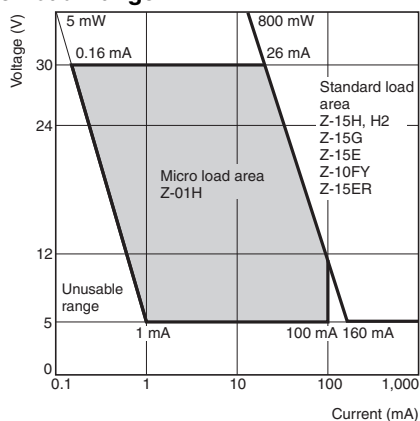

	Z-01H	Z-15□, Z-10FY
Minimum applicable load	1 mA at 5 VDC	160 mA at 5 VDC

■ Contacts Specification

Item	Classification	Z-15	Z-01H	Z-10F
Contacts	Shape	Rivet	Single crossbar	Rivet
	Material	Silver	Gold alloy	Silver
Inrush current	NC	30 A max.	0.1 A max.	40 A max.
	NO	15 A max.	0.1 A max.	20 A max.

■ Safety Standards Ratings

UL/CSA (General ratings only)

Rated voltage	Model	Z-15	Z-10F	Z-01H
125 VAC		15A and 1/8HP	6A and 1/10HP	0.1A
250 VAC		15A and 1/4HP	6A and 1/8HP	---
480 VAC		15A	6A	---
30 VDC		---	---	0.1A
125 VDC		0.5A	0.6A	---
250 VDC		0.25A	0.3A	---

TÜV (EN61058-1)

Rated voltage	Model	Z-15H□-B	Z-15G□-B	Z-01H□-B
250 VAC		15 A	15 A	---
125 VAC		---	---	0.1 A
30 VDC		---	---	0.1 A

- Note:**
- The above current ratings are the values of the steady-state current.
 - Inductive load has a power factor of 0.4 min. (AC) and a time constant of 7 ms max. (DC).
 - Lamp load has an inrush current of 10 times the steady-state current.
 - Motor load has an inrush current of 6 times the steady-state current.
 - The normally closed and normally open ratings of reverse hinge lever models are opposite to each other.

- The AC ratings of molded terminals are 125 and 250 V only.
- The ratings values apply under the following test conditions:
 - Ambient temperature: 20±2°C
 - Ambient humidity: 65±5%RH
 - Operating frequency: 20 operations/min
- Consult Omron regarding CCC standards and ratings.

Engineering Data

Mechanical Durability (Z-15G)

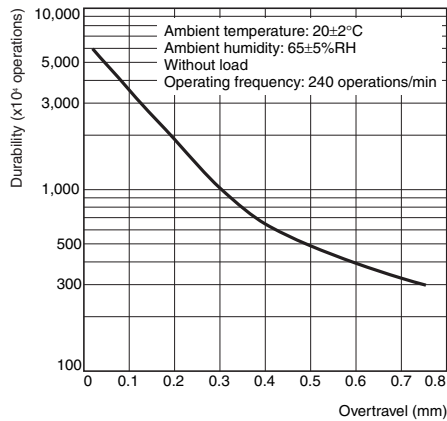

Electrical Durability (Z-15G)

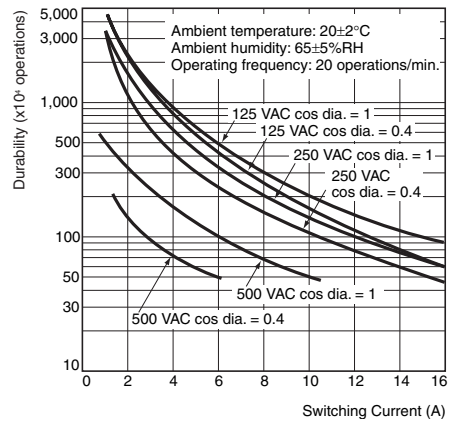

Structure

Basic Models

Contact Form (SPDT)

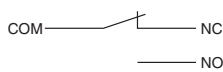

Note: The Z-15GM is a reversible model and the NO and NC positions are reversed.

Molded Terminals

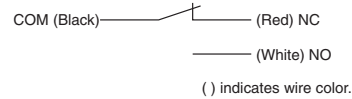

Note: The Z-15GM is a reversible model and the NO and NC positions are reversed.

Drip-proof Construction

Without Terminal Protective Cover

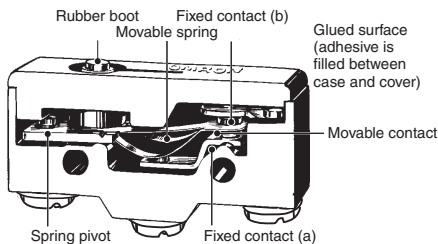

With Terminal Protective Cover

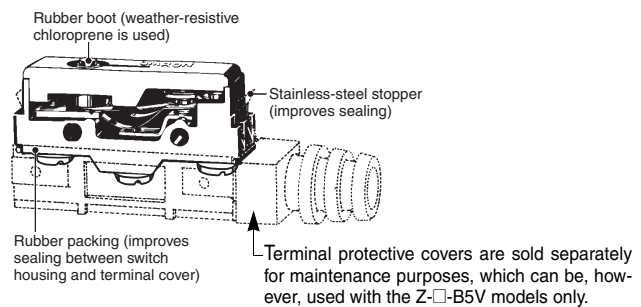

Split-Contact Models

Contact Form

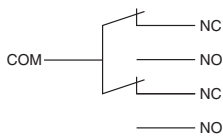

Note: The NO and NC terminal arrangement is reversed for Models with reverse operation (Z-10FM).

Connection Example

Series Connection

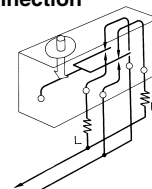

Parallel Connection

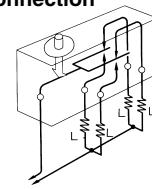

Maintained-contact Models

Contact Form

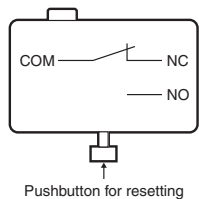

Dimensions

General-purpose and Split Contact Models

Note: Unless otherwise specified, all units are in millimeters and a tolerance of ± 0.4 mm applies to all dimensions

Terminals

General-purpose Models		Split-contact Models
<p>Screw Terminals (-B)</p> <p>Three, M4 x 5.5 Terminal screws (with toothed washer)</p> <p>Appropriate terminal screw tightening torque: 0.78 to 1.18 N-m.</p>	<p>Solder Terminal (Blank)</p> <p>49.2</p>	<p>Screw Terminals (Y-B)</p> <p>Five, M3.5 x 5.5 terminal screws (with toothed washer)</p> <p>Appropriate terminal screw tightening torque: 0.49 to 0.78 N-m.</p> <p>Note: With reverse action models (Z-10FM), the positions of NO and NC terminals are reversed.</p>
<p>Note: With reverse action models (Z-15GM), the positions of NO and NC terminals are reversed.</p>		

Mounting

All switches can be side mounted using M4 mounting screws with plane washers or spring washers to securely mount the Switch. Tighten the screws to a torque of 1.18 to 1.47 N-m.

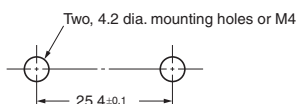

Versions with panel mount plungers can be panel mounted via the plunger, provided that the hexagonal nut of the actuator is tightened to a torque of 2.94 to 4.9 N-m.

Panel Mount Plunger

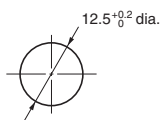

Panel Mount Roller Plunger

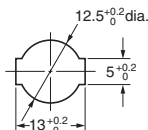

Note: Mount using either the side mounting holes or the panel mount plunger, not both. If using the side mounting holes, then remove the hexagonal nut(s) from the panel mount plunger.

Accessories (Terminal Covers, Actuators, and Separators): Refer to 'Z/A/X/DZ Common Accessories' datasheet

Note: 1. All drawings show the switches with screw terminals. For versions with solder terminals, remove the “-B” from the end of the part number.
 2. Unless otherwise specified, all units are in millimeters and a tolerance of ± 0.4 mm applies to all dimensions.

Pin Plunger

Z-15G-B Z-15E-B
 Z-15H2-B Z-01H-B
 Z-15H-B Z-10FY-B

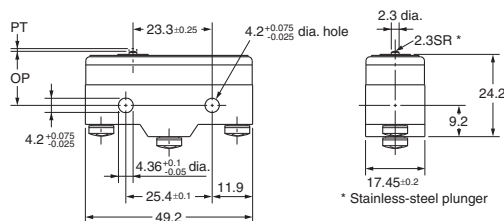

Operating Characteristics		Z-15G-B	Z-15H2-B	Z-15H-B	Z-15E-B	Z-01H-B	Z-10FY-B
Operating force	OF	250 to 350 gf	200 to 255 gf	200 to 280 gf	625 to 800 gf	250 gf max.	455 to 740 gf
Release force	RF min.	114 gf	114 gf	114 gf	114 gf	80 gf	114 gf
Pretravel	PT max.	0.4 mm	0.3 mm	0.3 mm	0.8 mm	0.5 mm	0.8 mm
Overtravel	OT min.	0.13 mm	0.13 mm	0.13 mm	0.13 mm	0.13 mm	0.13 mm
Movement Differential	MD max.	0.05 mm	0.005 to 0.008 mm	0.025 mm	0.13 mm	0.04 mm	0.1 mm
Operating Position	OP	15.9±0.4 mm					

Slim Spring Plunger

Z-15GS-B Z-01HS-B
 Z-15HS-B Z-10FSY-B

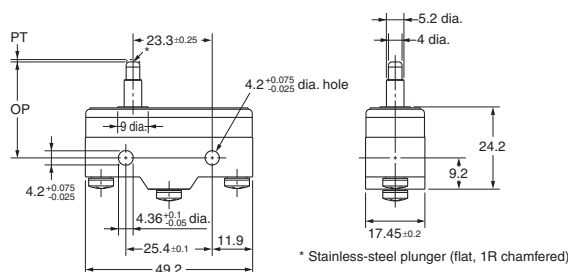
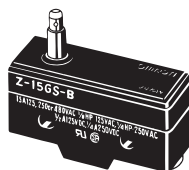

Model	Z-15GS-B	Z-15HS-B	Z-01HS	Z-10FSY-B
OF	250 to 350 gf	200 to 285 gf	250 gf max.	455 to 740 gf
RF min.	114 gf	114 gf	80 gf	114 gf
PT max.	0.4 mm	0.3 mm	0.5 mm	0.8 mm
OT min.	1.6 mm	1.6 mm	1.6 mm	1.6 mm
MD max.	0.05 mm	0.025 mm	0.05 mm	0.1 mm
OP	28.2±0.5 mm			

Short Spring Plunger

Z-15GD-B Z-01HD-B
 Z-15HD-B Z-10FDY-B
 Z-15ED-B

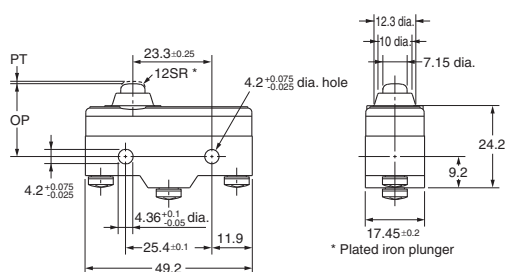
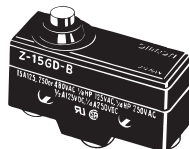

Model	Z-15GD-B	Z-15HD-B	Z-15ED-B	Z-01HD-B	Z-10FDY-B
OF	250 to 350 gf	200 to 285 gf	625 to 800 gf	250 gf max.	455 to 740 gf
RF min.	114 gf	114 gf	114 gf	80 gf	114 gf
PT max.	0.4 mm	0.3 mm	0.8 mm	0.5 mm	0.8 mm
OT min.	1.6 mm	1.6 mm	1.6 mm	1.6 mm	1.6 mm
MD max.	0.05 mm	0.025 mm	0.13 mm	0.05 mm	0.1 mm
OP	21.5±0.5 mm				

Note: 1. All drawings show the switches with screw terminals. For versions with solder terminals, remove the “-B” from the end of the part number.
2. Unless otherwise specified, all units are in millimeters and a tolerance of ± 0.4 mm applies to all dimensions.

Panel Mount Plunger

Z-15GQ-B Z-01HQ-B
Z-15HQ-B Z-10FQY-B
Z-15EQ-B Z-15GQ3-B *
Z-15GQ8-B *

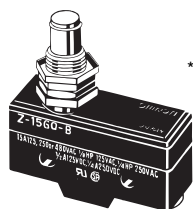

* The external dimensions of the actuator vary.

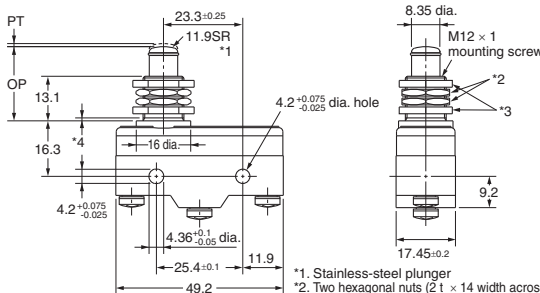

*1. Stainless-steel plunger
*2. Two hexagonal nuts (2 t x 14 width across flats)
*3. Two lock nuts (2 t x 15.6 width across flats)
*4. Incomplete screw part with a maximum length of 1.5 mm.

- Note:** 1. Do not use the M12 mounting screw and the case mounting hole at the same time, or excessive pulling force will be imposed on the switch and the case and cover may be damaged.
2. On the model Z-15GQ3-B, PT can be set to a value larger than that for the Z-15GQ.
3. On the model Z-15GQ8-B, operating position can be adjusted by providing a screw in the plunger section.
4. On the model Z-15GQ8-B, the M3 hole with a depth of 10 mm is a through hole. Take precautions so that no water or screw lock agent penetrates into the hole.

Model	Z-15GQ-B	Z-15HQ-B	Z-15EQ-B	Z-01HQ-B	Z-10FQY-B	Z-15GQ3-B	Z-15GQ8-B
OF	250 to 350 gf	200 to 285 gf	625 to 800 gf	250 gf max.	455 to 740 gf	250 to 350 gf	250 to 350 gf
RF min.	114 gf	114 gf	114 gf	80 gf	114 gf	114 gf	114 gf
PT max.	0.4 mm	0.3 mm	0.8 mm	0.5 mm	0.8 mm	4.2 mm	0.5 mm
OT min.	5.5 mm	5.5 mm	5.5 mm	5.5 mm	5.5 mm	2.5 mm	5.5 mm
MD max.	0.05 mm	0.025 mm	0.13 mm	0.05 mm	0.1 mm	2.2 mm	0.05 mm
OP	21.8±0.8 mm					18.8±0.8 mm	32.5±1 mm

Panel Mount Roller Plunger

Z-15GQ22-B Z-15EQ22-B
Z-15HQ22-B Z-10FQ22Y-B

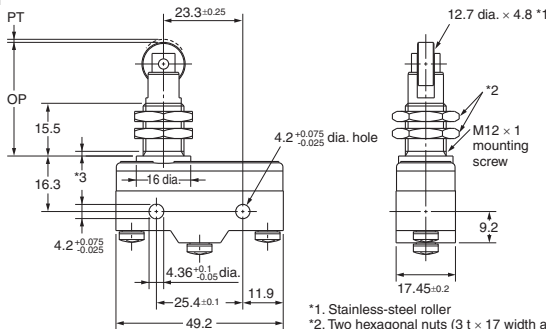
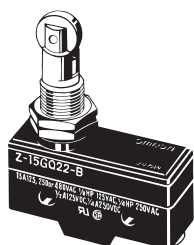

*1. Stainless-steel roller
*2. Two hexagonal nuts (3 t x 17 width across flats)
*3. Incomplete screw part with a maximum length of 1.5 mm.

Note: Do not use the M12 mounting screw and the case mounting hole at the same time, or the case may be damaged.

Model	Z-15GQ22-B	Z-15HQ22-B	Z-15EQ22-B	Z-10FQ22Y-B
OF	250 to 350 gf	200 to 285 gf	625 to 800 gf	455 to 740 gf
RF min.	114 gf	114 gf	114 gf	114 gf
PT max.	0.4 mm	0.3 mm	0.8 mm	1 mm
OT min.	3.58 mm	3.58 mm	3.58 mm	3.55 mm
MD max.	0.05 mm	0.025 mm	0.13 mm	0.1 mm
OP	33.4±1.2 mm			

Panel Mount Cross Roller Plunger

Z-15GQ21-B Z-15EQ21-B
Z-15HQ21-B

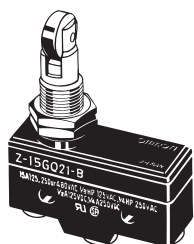

Note: Do not use the M12 mounting screw and the case mounting hole at the same time, or the case may be damaged.

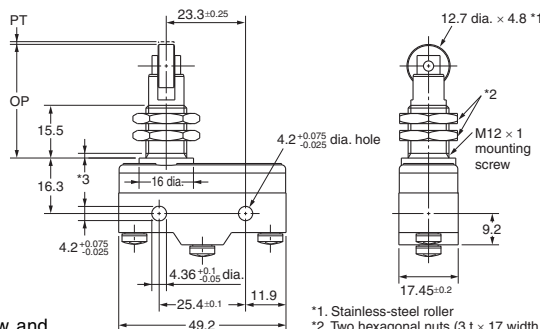

*1. Stainless-steel roller
*2. Two hexagonal nuts (3 t x 17 width across flats)
*3. Incomplete screw part with a maximum length of 1.5 mm.

Model	Z-15GQ21-B	Z-15HQ21-B
OF	250 to 350 gf	200 to 285 gf
RF min.	114 gf	114 gf
PT max.	0.4 mm	0.3 mm
OT min.	3.58 mm	3.58 mm
MD max.	0.05 mm	0.025 mm
OP	33.4±1.2 mm	

Model	Z-15EQ21-B
OF	625 to 800 gf
RF min.	114 gf
PT max.	0.8 mm
OT min.	3.58 mm
MD max.	0.13 mm
OP	33.4±1.2 mm

Note: 1. All drawings show the switches with screw terminals. For versions with solder terminals, remove the “-B” from the end of the part number.
 2. Unless otherwise specified, all units are in millimeters and a tolerance of ± 0.4 mm applies to all dimensions.

Leaf Spring
Z-15GL-B

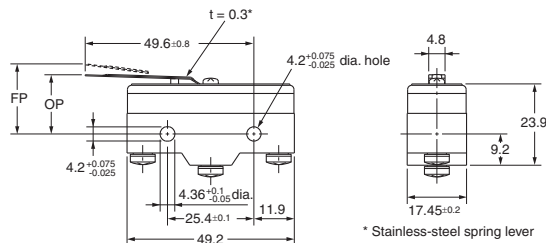
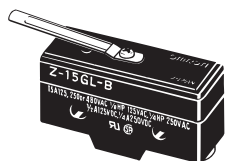

OF max.	141 gf
RF min.	14 gf
*OT min.	1.6 mm
MD max.	1.3 mm
FP max.	20.6 mm
OP	17.4±0.8 mm

* When operating, be sure not to exceed 1.6 mm.

Roller Leaf Spring
Z-15GL2-B

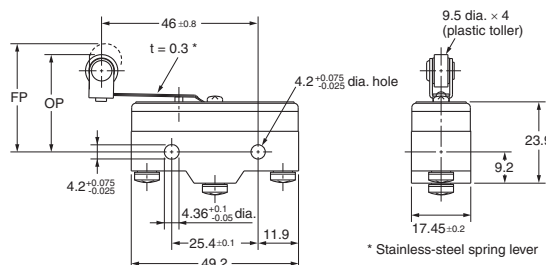
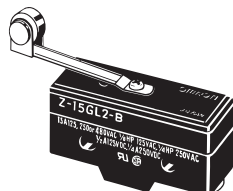

OF max.	141 gf
RF min.	14 gf
*OT min.	1.6 mm
MD max.	1.3 mm
FP max.	31.8 mm
OP	28.6±0.8 mm

* When operating, be sure not to exceed 1.6 mm.

Short Hinge Lever
Z-15GW21-B

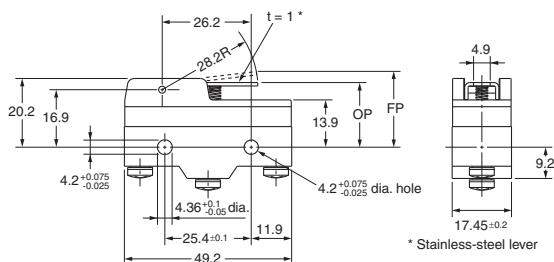
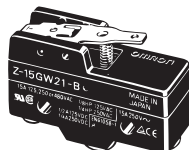

OF max.	160 gf
RF min.	28 gf
OT min.	2 mm
MD max.	1 mm
FP max.	24.8 mm
OP	19±0.8 mm

Hinge Lever
Z-15GW-B Z-15GW32-B
Z-15HW-B Z-10FWY-B
Z-15GW3-B (Lever Length: 56R)*

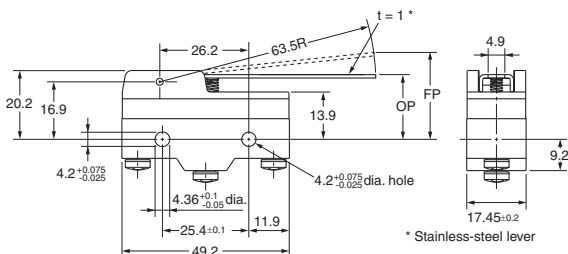
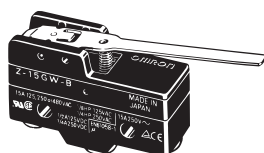

* The external dimensions of the actuator vary.

Model	Z-15GW-B	Z-15HW-B	Z-15GW32-B	Z-10FWY-B	Z-15GW3-B
OF	70 gf max.	67 gf max.	150 to 200 gf	90 gf max.	80 gf max.
RF min.	14 gf	14 gf	93 gf	14 gf	15 gf
OT min.	5.6 mm	5.6 mm	5.6 mm	5.6 mm	4.8 mm
MD max.	1.27 mm	0.63 mm	1.27 mm	2.4 mm	1.12 mm
FP max.	28.2 mm	27.4 mm	28.2 mm	29.8 mm	27.2 mm
OP	19±0.8 mm				

Note: 1. All drawings show the switches with screw terminals. For versions with solder terminals, remove the “-B” from the end of the part number.
 2. Unless otherwise specified, all units are in millimeters and a tolerance of ± 0.4 mm applies to all dimensions.

Low-force Hinge Lever

Z-15GW4-B

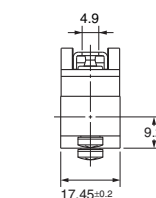
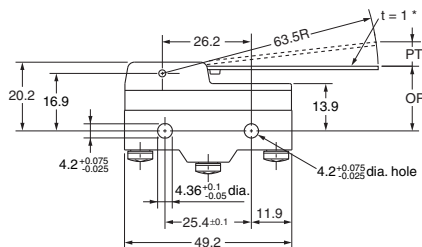
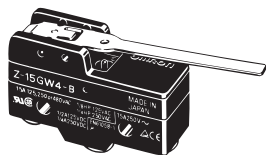

* Stainless-steel lever

OF max.	28 gf
RF min.	3.5 gf
PT max.	10 mm
OT min.	5.6 mm
MD max.	1.27 mm
OP	19±0.8mm

Z-15HW24-B

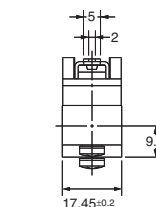
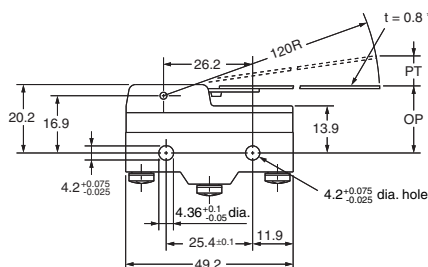
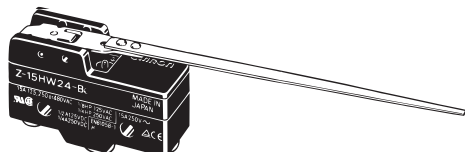

* Stainless-steel lever

OF max.	6 gf
RF min.	0.5 gf
PT max.	19.8 mm
OT min.	10 mm
MD max.	2 mm
OP	19.8±1.6 mm

Low-force Wire Hinge Lever

Z-15HW52-B

Z-15HW78-B (Lever Length: 110R) *

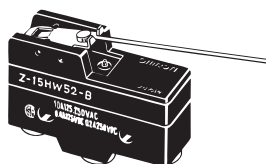

* The external dimensions of the actuator vary.

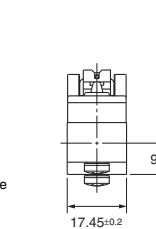
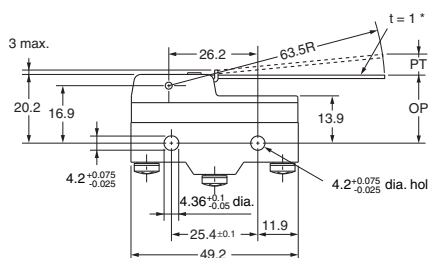

* Stainless-steel wire lever

Model	Z-15HW52-B
OF max.	6 gf
RF min.	0.5 gf
PT max.	8.3 mm
OT min.	5.6 mm
MD max.	0.65 mm
OP	19±1 mm

Model	Z-15HW78-B
OF max.	4 gf
RF min.	0.3 gf
PT max.	10 mm
OT min.	6 mm
MD max.	3 mm
OP	20±1 mm

Note: AC electrical ratings: 10 A, 125/250 V.

Short Hinge Roller Lever

Z-15GW22-B Z-01HW22-B

Z-15HW22-B Z-10FW22Y-B

Z-15EW22-B

Z-15GW2-B * Z-15HW2-B *

Z-10FW2Y-B *

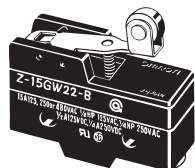

* The external dimensions of the actuator vary. (Lever Length: 48.5R)

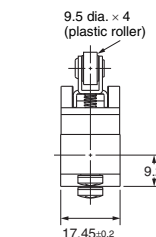
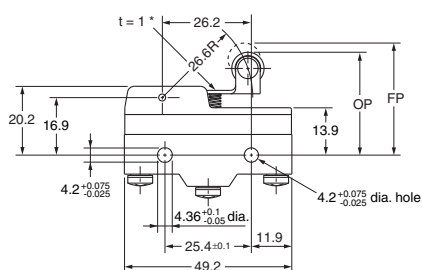

* Stainless-steel lever

Model	Z-15GW22-B	Z-15HW22-B	Z-15EW22-B	Z-01HW22-B	Z-10FW22Y-B	Z-15GW2-B	Z-15HW2-B	Z-10FW2Y-B
OFmax.	160 gf	150 gf	198 gf	160 gf	250 gf	100 gf	86 gf	130 gf
RF min.	42 gf	42 gf	42 gf	28 gf	35 gf	22 gf	22 gf	22 gf
OT min.	2.4 mm	2.4 mm	2.4 mm	2.4 mm	2.4 mm	4 mm	4 mm	4 mm
MD max.	0.5 mm	0.45 mm	1.3 mm	0.5 mm	1 mm	1.02 mm	0.6 mm	2 mm
FP max.	32.5 mm		35.1 mm	32.5 mm	34.8 mm	36.5 mm		37.4 mm
OP	30.2±0.4 mm		30.2±0.4 mm	30.2±0.4 mm	30.2±0.4 mm	30.2±0.8 mm		30.2±0.8 mm

Note: 1. All drawings show the switches with screw terminals. For versions with solder terminals, remove the “-B” from the end of the part number.
 2. Unless otherwise specified, all units are in millimeters and a tolerance of ± 0.4 mm applies to all dimensions.

Short Hinge Cross Roller Lever
Z-15GW49-B
Z-15GW54-B (Lever Length: 48.7R) *

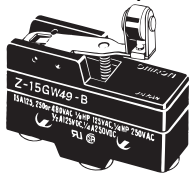

* The external dimensions of the actuator vary.

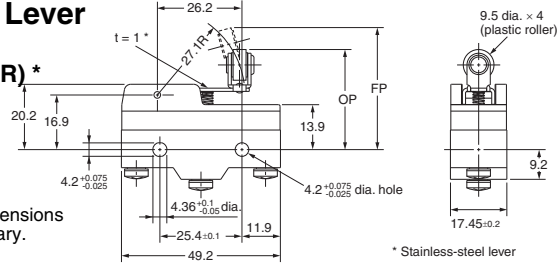

Model	Z-15GW49-B	Z-15GW54-B
OF max.	170 gf	100 gf
RF min.	42 gf	22 gf
OT min.	2.4 mm	4 mm
MD max.	0.51 mm	1 mm
FP max.	33.3 mm	37.3 mm
OP	31 \pm 0.4 mm	31 \pm 0.8 mm

Hinge Roller Lever
Z-15GW25-B

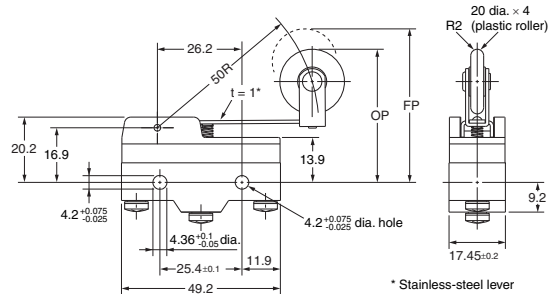
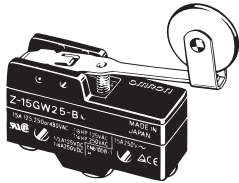

OF max.	100 gf
RF min.	21 gf
OT min.	4 mm
MD max.	1.6 mm
FP max.	47.5 mm
OP	41.2 \pm 0.8 mm

Unidirectional Short Hinge Roller Lever
Z-15GW227-B

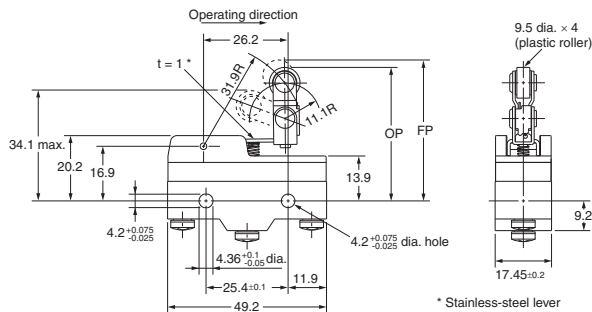
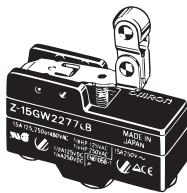

OF max.	170 gf
RF min.	42 gf
OT min.	2.4 mm
MD max.	0.51 mm
FP max.	43.6 mm
OP	41.3 \pm 0.8 mm

Reverse Hinge Lever **
Z-15GM-B

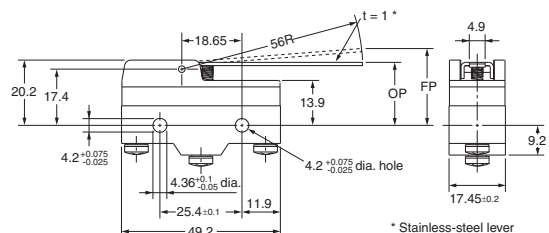
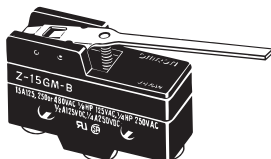

OF max.	170 gf
RF min.	28 gf
OT min.	5.6 mm
MD max.	0.89 mm
FP max.	23.8 mm
OP	19 \pm 0.8 mm

Reverse Short Hinge Roller Lever **
Z-15GM22-B
Z-10FM22Y-B

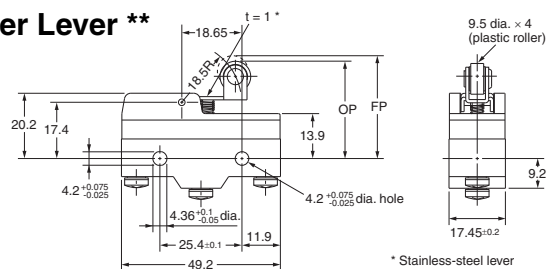
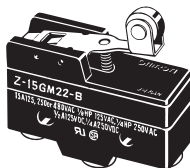

	Z-15GM22-B	Z-10FM22Y-B
OF max.	538 gf	650 gf
RF min.	170 gf	170 gf
OT min.	2 mm	2 mm
MD max.	0.28 mm	0.56 mm
FP max.	31.8 mm	33 mm
OP	29.4 \pm 0.4 mm	29.4 \pm 0.4 mm

Reverse Hinge Roller Lever **
Z-15GM2-B

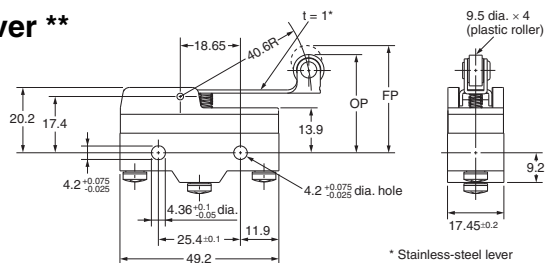
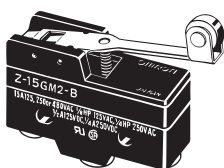

OF max.	240 gf
RF min.	56 gf
OT min.	4 mm
MD max.	0.64 mm
FP max.	35 mm
OP	30.2 \pm 0.8 mm

**The pin plungers of reverse-type models are continuously pressed by the actuator levers with compression coil springs and the pin plungers are freed by operating the levers. Reverse-type models are highly vibration- and shock-resistant because the pin plungers are normally pressed.

■ Drip-proof Models (without Terminal Protective Cover)

Note: 1. All drawings show the switches with screw terminals. For versions with solder terminals, remove the “-B” from the end of the part number.
 2. Unless otherwise specified, all units are in millimeters and a tolerance of ± 0.4 mm applies to all dimensions.

Terminals

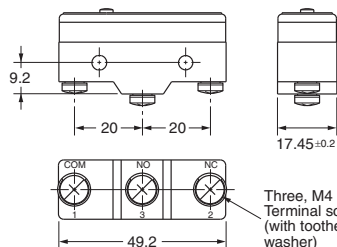

Note: With reverse action models (Z-15GM), the positions of NO and NC terminals are reversed.

Pin Plunger

Z-15G55-B
Z-01H55-B

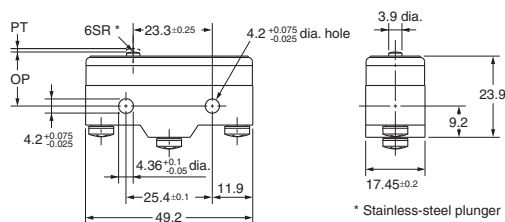

Model	Z-15G55-B	Z-01H55-B
OF	250 to 430 gf	350 gf max.
RF min.	114 gf	80 gf
PT max.	2.2 mm	2.2 mm
OT min.	0.13 mm	0.13 mm
MD max.	0.06 mm	0.06 mm
OP	15.9±0.4 mm	

Short Spring Plunger

Z-15GD55-B
Z-01HD55-B

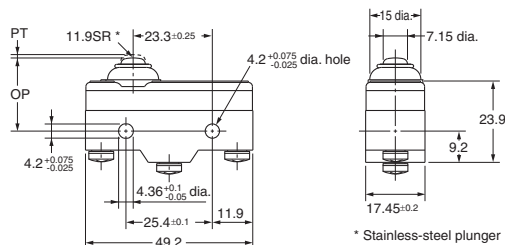

Model	Z-15GD55-B	Z-01HD55-B
OF max.	540 gf	370 gf
RF min.	114 gf	80 gf
PT max.	1.8 mm	1.9 mm
OT min.	1.6 mm	1.6 mm
MD max.	0.06 mm	0.06 mm
OP	21.5±0.5 mm	

Spring Plunger

Z-15GK55-B

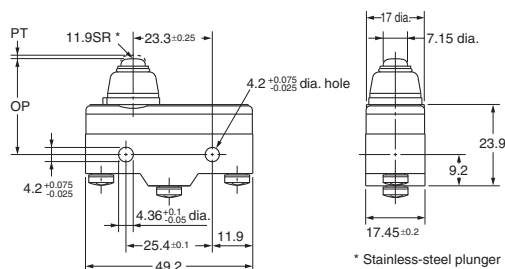
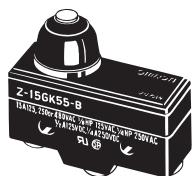

OF max.	540 gf
RF min.	114 gf
PT max.	2.3 mm
OT min.	1.6 mm
MD max.	0.06 mm
OP	28.2±0.5 mm

Z-15GK355-B

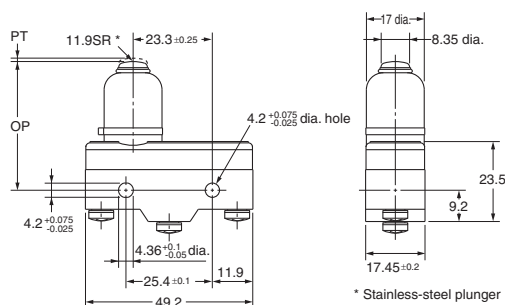
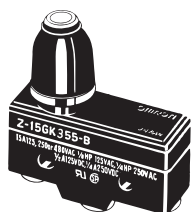

OF max.	540 gf
RF min.	114 gf
PT max.	2.4 mm
OT min.	3.5 mm
MD max.	0.06 mm
OP	37.8±1.2 mm

Note: 1. All drawings show the switches with screw terminals. For versions with solder terminals, remove the “-B” from the end of the part number.
 2. Unless otherwise specified, all units are in millimeters and a tolerance of ± 0.4 mm applies to all dimensions.

Panel Mount Plunger
Z-15GQ55-B

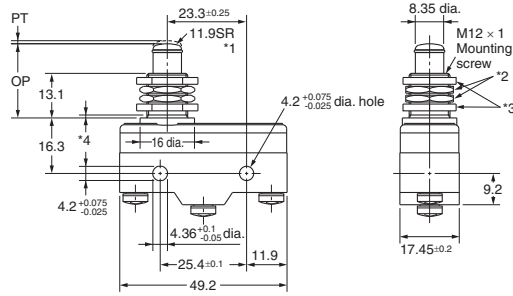
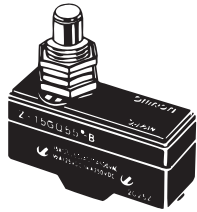

- *1. Stainless-steel plunger
- *2. Two hexagonal nuts (2 t x 14 width across flats)
- *3. Two lock nuts (2 t x 15.6 width across flats)
- *4. Incomplete screw part with a maximum length of 1.5 mm.

OF max.	540 gf
RF min.	114 gf
PT max.	1.8 mm
OT min.	5.5 mm
MD max.	0.06 mm
OP	21.8 ± 0.8 mm

Note: Do not use the M12 mounting screw and the case mounting hole at the same time, or the case may be damaged.

Panel Mount Roller Plunger
Z-15GQ2255-B

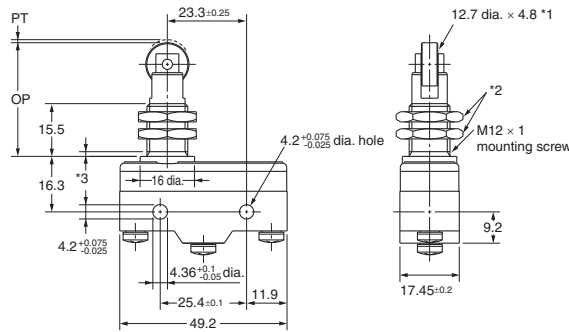
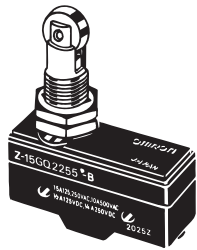

- *1. Stainless-steel roller
- *2. Two hexagonal nuts (3 t x 17 width across flats)
- *3. Incomplete screw part with a maximum length of 1.5 mm.

OF max.	540 gf
RF min.	114 gf
PT max.	1.8 mm
OT min.	3.58 mm
MD max.	0.06 mm
OP	33.4 ± 1.2 mm

Note: Do not use the M12 mounting screw and the case mounting hole at the same time, or the case may be damaged.

Panel Mount Cross Roller Plunger
Z-15GQ2155-B

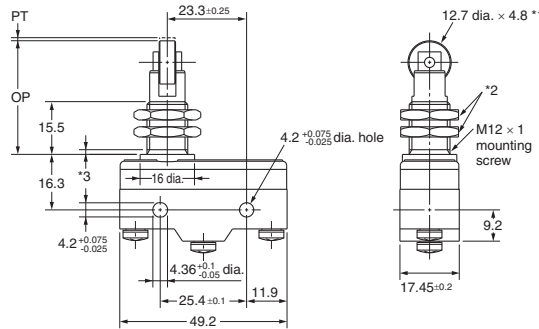
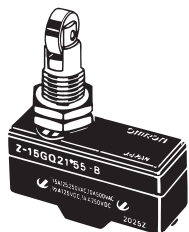

- *1. Stainless-steel roller
- *2. Two hexagonal nuts (3 t x 17 width across flats)
- *3. Incomplete screw part with a maximum length of 1.5 mm.

OF max.	540 gf
RF min.	114 gf
PT max.	1.8 mm
OT min.	3.58 mm
MD max.	0.06 mm
OP	33.4 ± 1.2 mm

Note: Do not use the M12 mounting screw and the case mounting hole at the same time, or the case may be damaged.

Leaf Spring
Z-15GL55-B

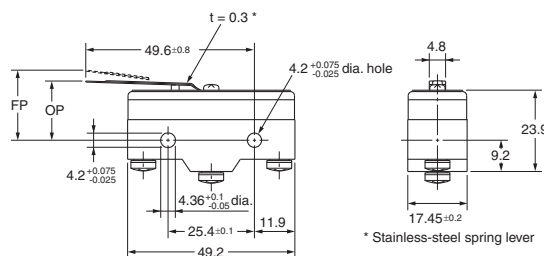
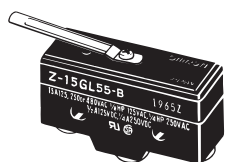

* Stainless-steel spring lever

OF max.	200 gf
RF min.	14 gf
*OT min.	1.6 mm
MD max.	1.3 mm
FP max.	20.6 mm
OP	17.5 ± 0.8 mm

* When operating, be sure not to exceed 1.6 mm.

- Note:** 1. All drawings show the switches with screw terminals. For versions with solder terminals, remove the “-B” from the end of the part number.
 2. Unless otherwise specified, all units are in millimeters and a tolerance of ± 0.4 mm applies to all dimensions.

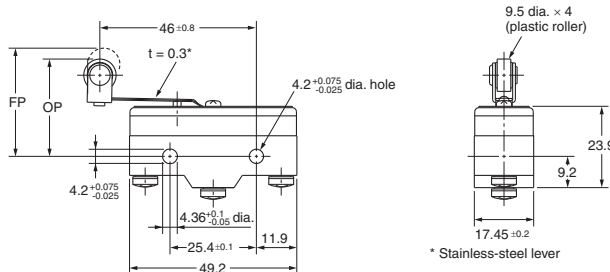
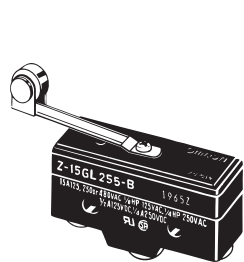

OF max.	200 gf
RF min.	14 gf
* OT min.	1.6 mm
MD max.	1.3 mm
FP max.	31.8 mm
OP	28.6±0.8 mm

* When operating, be sure not to exceed 1.6 mm.

Short Hinge Lever
Z-15GW2155-B

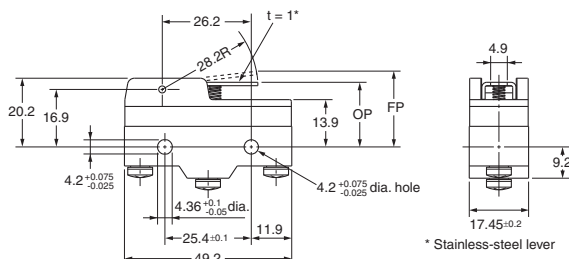
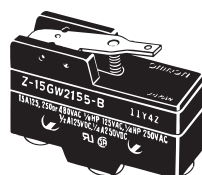

OF max.	190 gf
RF min.	28 gf
OT min.	2 mm
MD max.	1 mm
FP max.	25 mm
OP	19±0.8 mm

Long Hinge Lever
Z-15GW4455-B

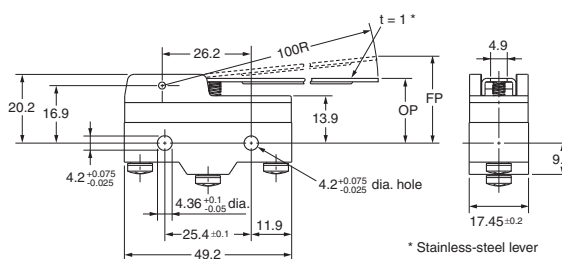
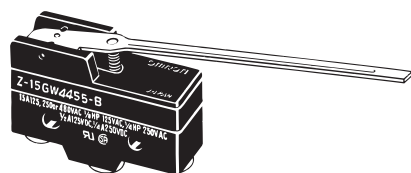

OF max.	90 gf
RF min.	14 gf
OT min.	5.6 mm
MD max.	3.5 mm
FP max.	33 mm
OP	19±1.2 mm

Hinge Lever
Z-15GW55-B

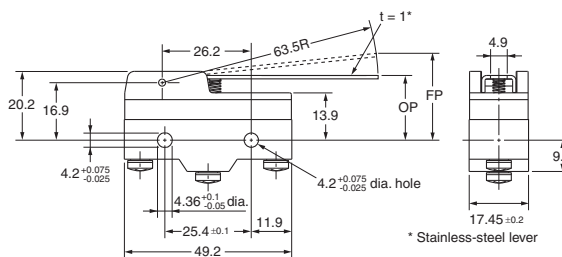
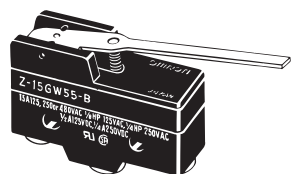

OF max.	100 gf
RF min.	14 gf
OT min.	5.6 mm
MD max.	2 mm
FP max.	28.2 mm
OP	19±0.8 mm

Short Hinge Roller Lever
Z-15GW2255-B
Z-01HW2255-B

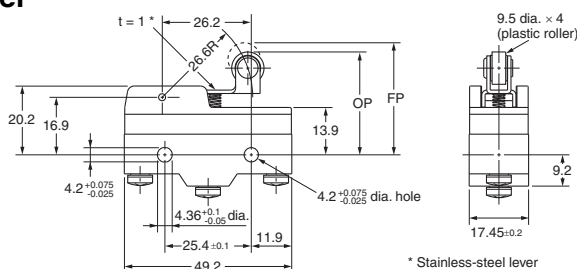
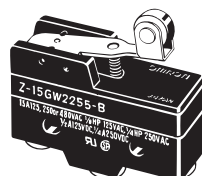

Model	Z-15GW2255-B	Z-01HW2255-B
OF max.	200 gf	200 gf
RF min.	42 gf	28 gf
OT min.	2.4 mm	2.4 mm
MD max.	0.8 mm	0.8 mm
FP max.	32.9 mm	
OP	30.2±0.4 mm	

Note: 1. All drawings show the switches with screw terminals. For versions with solder terminals, remove the “-B” from the end of the part number.
 2. Unless otherwise specified, all units are in millimeters and a tolerance of ± 0.4 mm applies to all dimensions.

Hinge Roller Lever
Z-15GW255-B

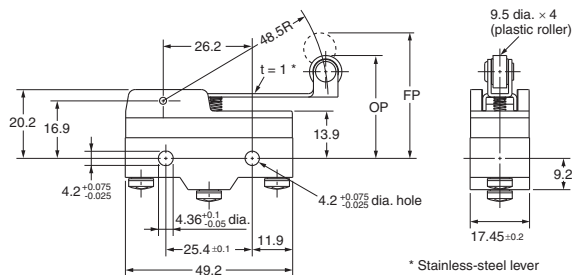
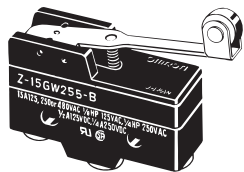

OF max.	130 gf
RF min.	21 gf
OT min.	4 mm
MD max.	1.6 mm
FP max.	36.5 mm
OP	30.2±0.8 mm

Unidirectional Short Hinge Roller Lever
Z-15GW227755-B

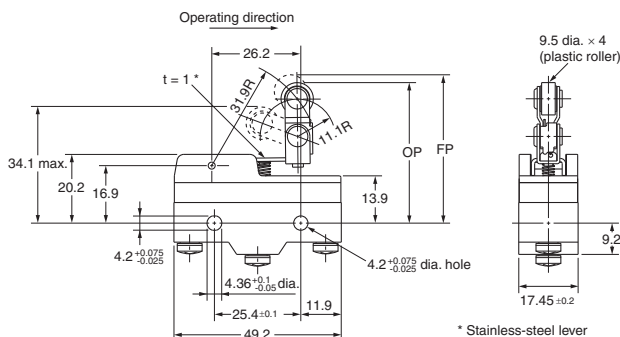
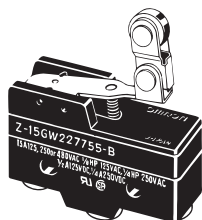

OF max.	180 gf
RF min.	50 gf
OT min.	2.4 mm
MD max.	0.8 mm
FP max.	43.6 mm
OP	41.3±0.8 mm

Reverse Hinge Lever *
Z-15GM55-B

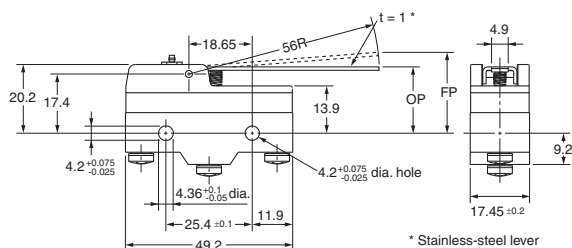
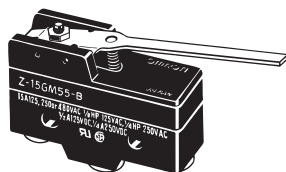

OF max.	200 gf
RF min.	28 gf
OT min.	5.6 mm
MD max.	0.89 mm
FP max.	23.8 mm
OP	19±0.8 mm

Reverse Short Hinge Roller Lever *
Z-15GM2255-B

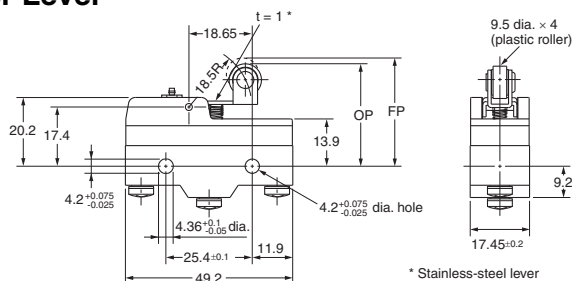
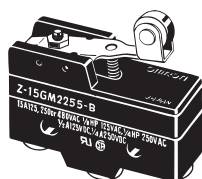

OF max.	580 gf
RF min.	170 gf
OT min.	2 mm
MD max.	0.28 mm
FP max.	31.8mm
OP	29.4±0.4mm

Reverse Hinge Roller Lever *
Z-15GM255-B

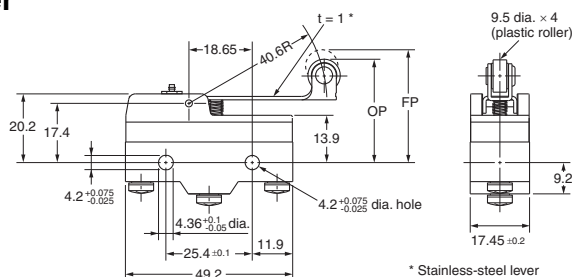
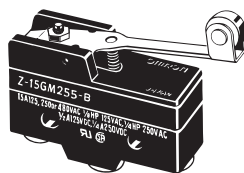

OF max.	270 gf
RF min.	56 gf
OT min.	4 mm
MD max.	0.64 mm
FP max.	35 mm
OP	30.2±0.8 mm

* The pin plungers of reverse-type models are continuously pressed by the actuator levers with compression coil springs and the pin plungers are freed by operating the levers.

Note: 1. All drawings show the switches with screw terminals. For versions with solder terminals, remove the “-B” from the end of the part number.
 2. Unless otherwise specified, all units are in millimeters and a tolerance of ± 0.4 mm applies to all dimensions.

Flexible Rod (Coil Spring)
Z-15GNJ55-B

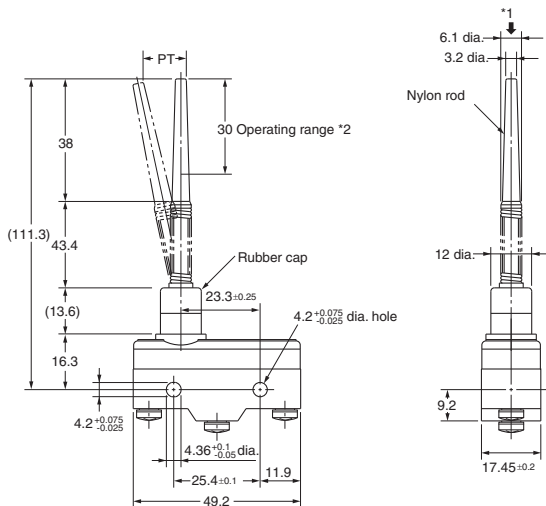
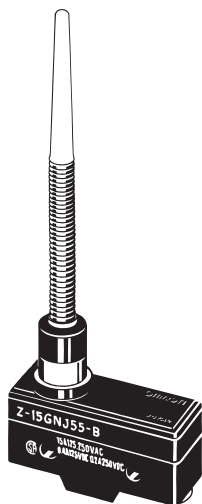

OF max.	50 gf
PT max.	(20 mm)
TT max.	40 mm

*1. Operation is possible in any direction other than the axial direction (indicated by the arrow \downarrow).
 *2. Use only the area within the top 30 mm of the rod as the operating part. (Do not use the area that falls within 80 mm from the mounting hole as the operating part. Using this area may cause damage to the nylon rod.)

Flexible Rod (Steel Wire)
Z-15HNJS55-B

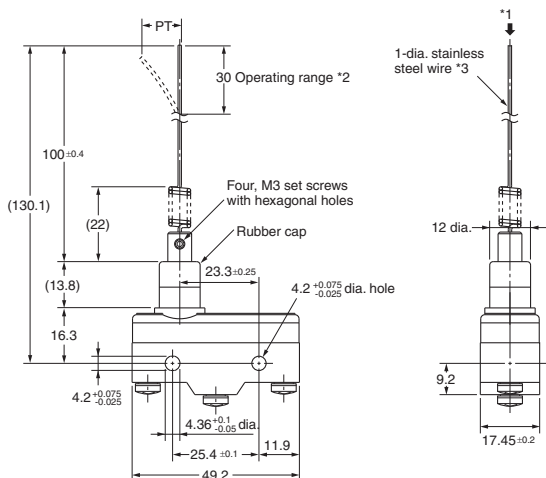
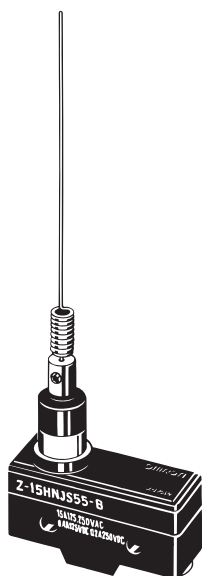

OF max.	15 gf
PT max.	(25 mm)

*1. Operation is possible in any direction other than the axial direction (indicated by the arrow \downarrow).
 *2. Use only the area within the top 30 mm of the rod as the operating part. (Do not use the area that falls within 100 mm from the mounting hole as the operating part. Using this area may cause damage to the steel wire.)
 *3. The steel wire can be replaced if damaged. (Model: Lever for HNJS55)

■ Drip-proof Models (with Terminal Protective Cover)

Note: Unless otherwise specified, all units are in millimeters and a tolerance of ± 0.4 mm applies to all dimensions.

Pin Plunger Z-15GA55-B5V

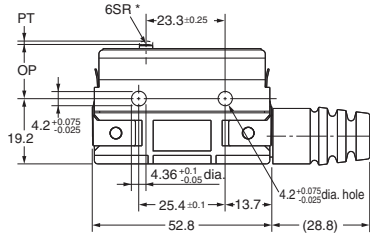
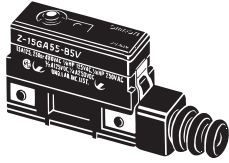

* Stainless-steel plunger

OF max.	250 to 430 gf
RF min.	114 gf
PT max.	2.2 mm
OT min.	0.13 mm
MD max.	0.06 mm
OP	15.9 \pm 0.4 mm

Z-15GK3A55-B5V

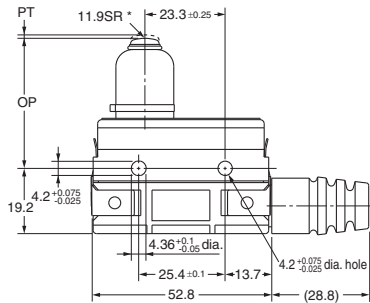
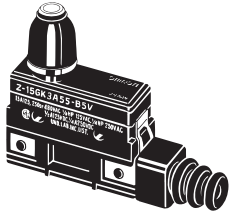

* Stainless-steel plunger

OF max.	540 gf
RF min.	114 gf
PT max.	2.4 mm
OT min.	3.5 mm
MD max.	0.06 mm
OP	37.8 \pm 1.2 mm

Panel Mount Plunger Z-15GQA55-B5V

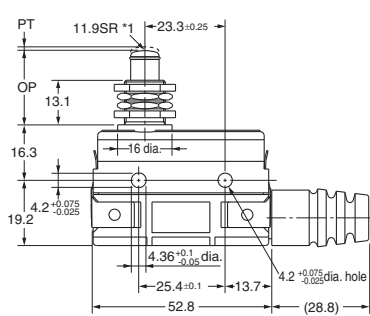
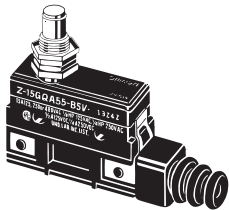

*1. Stainless-steel plunger
*2. Two hexagonal nuts (2 t x 14 width across flat)
*3. Two lock nuts (2 t x 15.6 width across flats)

OF max.	540 gf
RF min.	114 gf
PT max.	1.8 mm
OT min.	5.5 mm
MD max.	0.06 mm
OP	21.8 \pm 0.8 mm

Note: Do not use the M12 mounting screw and the case mounting hole at the same time, or the case may be damaged.

Panel Mount Roller Plunger Z-15GQ22A55-B5V

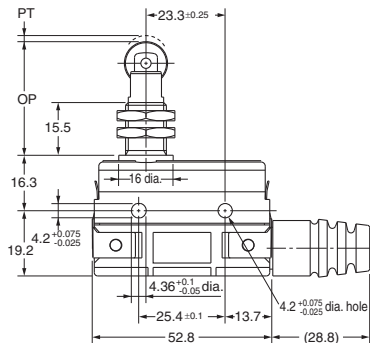
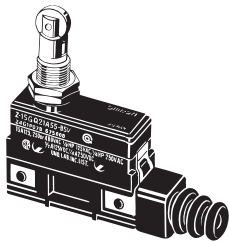

*1. Stainless-steel roller
*2. Two hexagonal nuts (3 t x 17 width across flats)

OF max.	540 gf
RF min.	114 gf
PT max.	1.8 mm
OT min.	3.58 mm
MD max.	0.06 mm
OP	33.4 \pm 1.2 mm

Note: Do not use the M12 mounting screw and the case mounting hole at the same time, or the case may be damaged.

Panel Mount Cross-roller Plunger Z-15GQ21A55-B5V

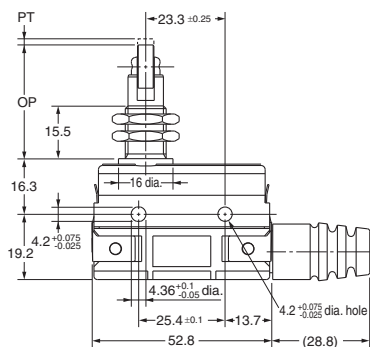
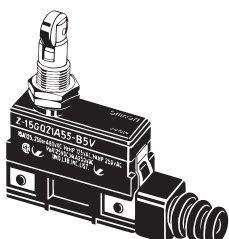

*1. Stainless-steel roller
*2. Two hexagonal nuts (3 t x 17 width across flats)

OF max.	540 gf
RF min.	114 gf
PT max.	1.8 mm
OT min.	3.58 mm
MD max.	0.06 mm
OP	33.4 \pm 1.2 mm

Note: Do not use the M12 mounting screw and the case mounting hole at the same time, or the case may be damaged.

Note: Unless otherwise specified, all units are in millimeters and a tolerance of ± 0.4 mm applies to all dimensions.

Long Hinge Lever
Z-15GW44A55-B5V

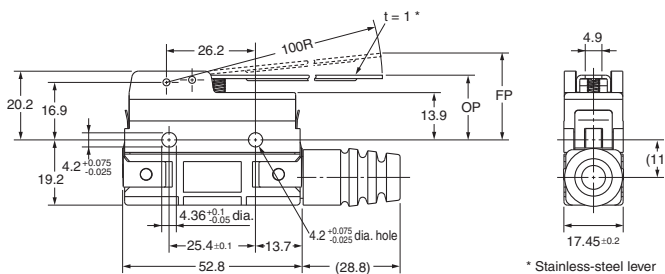
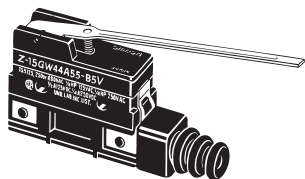

OF max.	90 gf
RF min.	14 gf
OT min.	5.6 mm
MD max.	3.5 mm
FP max.	33 mm
OP	19 ± 1.2 mm

* Stainless-steel lever

Hinge Lever
Z-15GWA55-B5V

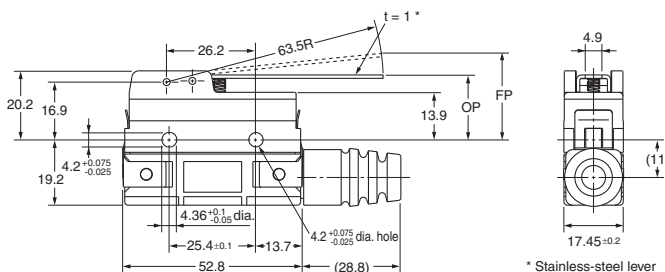
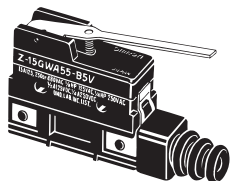

OF max.	100 gf
RF min.	14 gf
OT min.	5.6 mm
MD max.	2 mm
FP max.	28.2 mm
OP	19 ± 0.8 mm

* Stainless-steel lever

Short Hinge Roller Lever
Z-15GW22A55-B5V

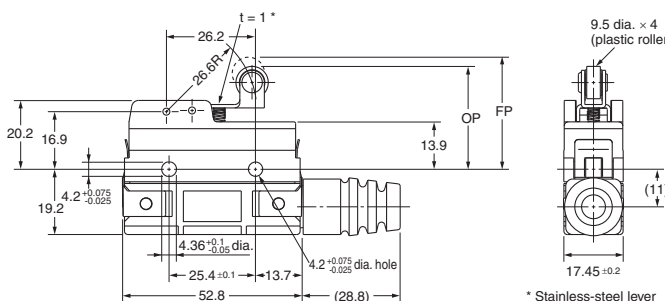

OF max.	200 gf
RF min.	42 gf
OT min.	2.4 mm
MD max.	0.8 mm
FP max.	32.9 mm
OP	30.2 ± 0.4 mm

* Stainless-steel lever

Hinge Roller Lever
Z-15GW2A55-B5V

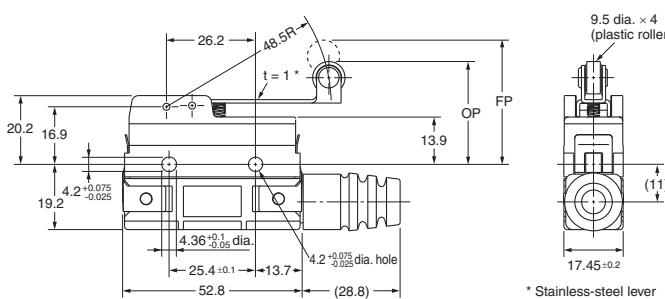
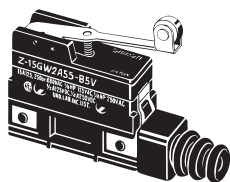

OF max.	130 gf
RF min.	21 gf
OT min.	4 mm
MD max.	1.6 mm
FP max.	36.5 mm
OP	30.2 ± 0.8 mm

* Stainless-steel lever

Unidirectional Short Hinge Roller Lever
Z-15GW2277A55-B5V

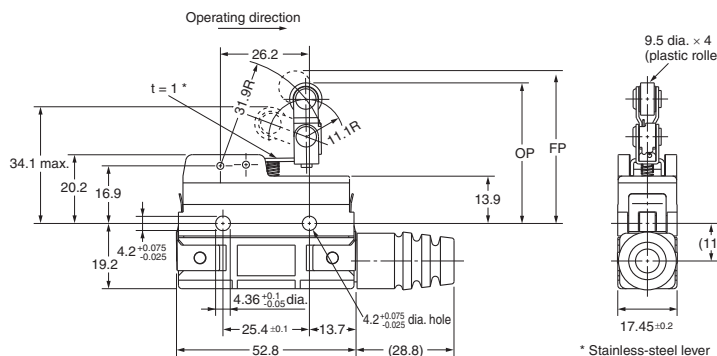
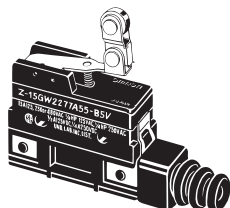

OF max.	180 gf
RF min.	50 gf
OT min.	2.4 mm
MD max.	0.8 mm
FP max.	43.6 mm
OP	41.3 ± 0.8 mm

* Stainless-steel lever

■ Drip-proof Models (with Molded Terminal Cover)

Note: Unless otherwise specified, all units are in millimeters and a tolerance of ± 0.4 mm applies to all dimensions.

L/R Type (The following illustration is the R type.)

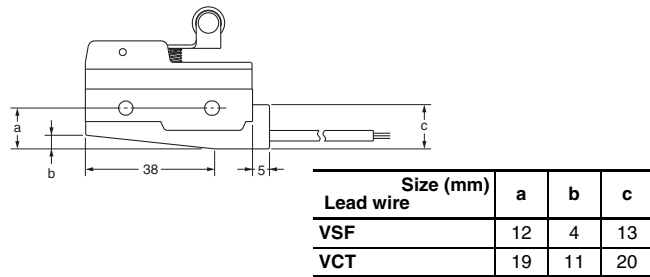

D Type

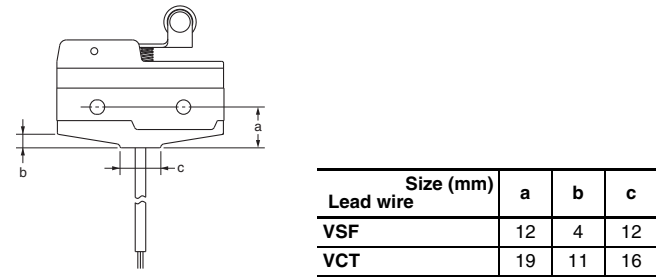

Lead Wire Specifications

Lead wire	Specifications	Nominal cross sectional area (mm ²)	Finished outer diameter (mm)	Connection to terminal	Length (m)
VSF (single-core, vinyl cord)		1.25	Approx. 3.1 dia.	Black: COM White: NO Red: NC	1, 3
VCT (vinyl-insulated cable)			Three-core: approx. 10.5 dia.		

- Note: 1. No models with molded terminals are approved by UL, CSA, or EN.
2. Molded terminals are not available on all models. Contact your OMRON representative for applicable products.

■ Maintained Contact Models

Note: Unless otherwise specified, all units are in millimeters and a tolerance of ± 0.4 mm applies to all dimensions.

Pin Plunger

Z-15ER

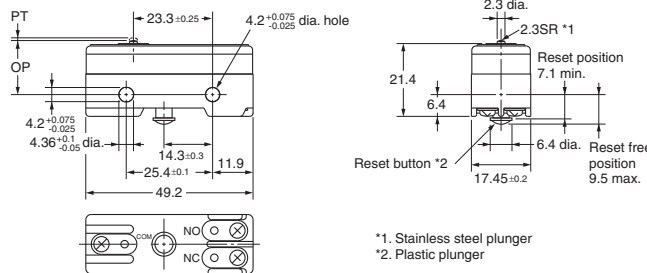

Plunger

OF	200 to 255 gf
PT max.	0.4 mm
OT min.	0.13 mm
OP	15.9±0.4 mm

Reset Button

OF max.	56 to 285 gf
OT min.	0.4 mm

Slim Spring Plunger

Z-15ESR

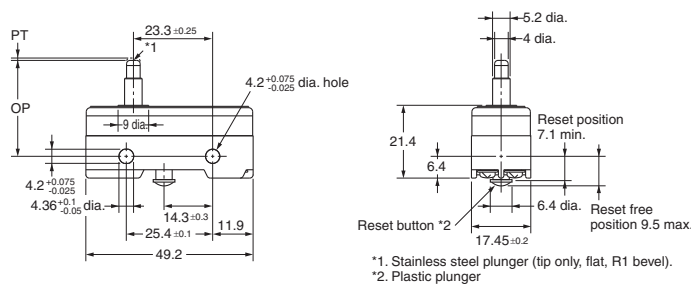
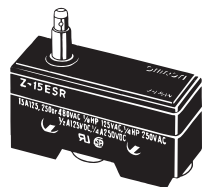

Plunger

OF max.	270 gf
PT max.	0.4 mm
OT min.	1.6 mm
OP	28.2±0.5 mm

Reset Button

OF max.	285 gf
OT min.	0.4 mm

Hinge Lever

Z-15EWR

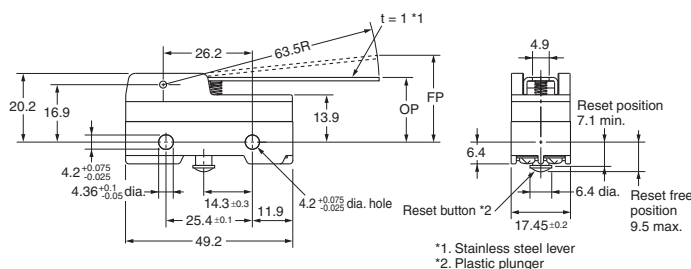
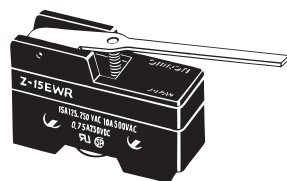

Lever Tip

OF max.	55 gf
OT min.	5.6 mm
FP max.	28.2 mm
OP	19±0.8 mm

Reset Button

OF max.	300 gf
OT min.	0.4 mm

Safety Precautions

Be sure to read the precautions and information common to all Snap Action and Detection Switches, contained in the Technical User's Guide, "Snap Action Switches, Technical Information" for correct use.

Precautions for Safe Use

Terminal Connection

When soldering lead wires to the Switch, make sure that the capacity of the soldering iron is 60 W maximum. Do not take more than 5 s to solder any part of the Switch. The characteristics of the Switch will deteriorate if a soldering iron with a capacity of more than 60 W is applied to any part of the Switch for 5 s or more.

Operation

- Make sure that the switching frequency or speed is within the specified range.
- 1. If the switching speed is extremely slow, the contact may not be switched smoothly, which may result in a contact failure or contact welding.
- 2. If the switching speed is extremely fast, switching shock may damage the Switch soon. If the switching frequency is too high, the contact may not catch up with the speed.

The rated permissible switching speed and frequency indicate the switching reliability of the Switch.

The life of a Switch is determined at the specified switching speed. The life varies with the switching speed and frequency even when they are within the permissible ranges. In order to determine the life of a Switch model to be applied to a particular use, it is best to conduct an appropriate durability test on some samples of the model under actual conditions.

- Make sure that the actuator travel does not exceed the permissible OT position. The operating stroke must be set to 70% to 100% of the rated OT.

Precautions for Correct Use

Mounting Location

- Do not use the switch alone in atmospheres such as flammable or explosive gases. Arcing and heat generation associated with switching may cause fires or explosions.
- Switches are generally not constructed with resistance against water. Use a protective cover to prevent direct spraying if the switch is used in locations subject to splashing or spurting oil or water, dust adhering.

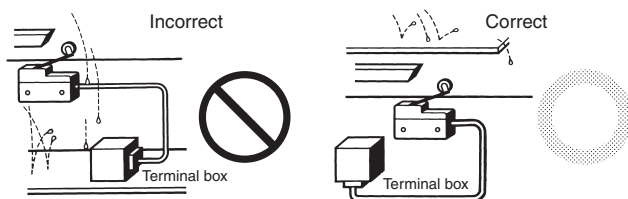

- Install the switch in a location that is not directly subject to debris and dust from cutting. The actuator and the switch body must be protected from accumulated cutting debris and dirt.

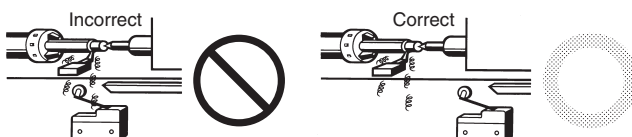

- Do not use the switch in locations subject to hot water (greater than 60°C) or in water vapor.
- Do not use the switch outside the specified temperature and atmospheric conditions. The permissible ambient temperature depends on the model. (Refer to the specifications in this catalog.) Sudden thermal changes may cause thermal shock to distort the switch and result in faults.

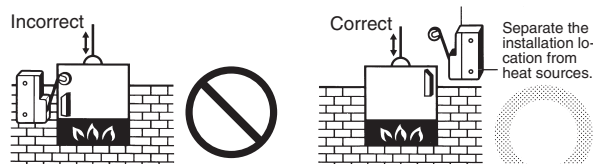

- Mount a cover if the switch is to be installed in a location where worker inattention could result in incorrect operation or accidents.



- Subjecting the switch to continuous vibration or shock may result in contact failure or faulty operation due to abrasion powder and in reduced durability. Excessive vibration or shock will cause the contacts to operate malfunction or become damaged. Mount the switch in a location that is not subject to vibration or shock and in a direction that does not subject the switch to resonance.
- If silver contacts are used with relatively low frequency for a long time or are used with microloads, the sulfide coating produced on the contact surface will not be broken down and contact faults will result. Use a microload switch that uses gold contacts.
- Do not use the switch in atmospheres with high humidity or heat or in harmful gases, such as sulfide gas (H₂S, SO₂), ammonia gas (NH₃), nitric acid gas (HNO₃), or chlorine gas (Cl₂). Doing so may impair functionality, such as with damage due to contacting faults or corrosion.
- The switch includes contacts. If the switch is used in an atmosphere with silicon gas, arc energy may cause silicon oxide (SiO₂) to accumulate on the contacts and result in contact failure. If there is silicon oil, silicon filling, silicon wiring, or other silicon products in the vicinity of the switch, use a contact protection circuit to limit arcing and remove the source of the silicon gas.

Mounting

Always make sure that the power is turned OFF before mounting, removing, or wiring the Switch, or performing maintenance. Electric shock or burning may occur.

Selecting Models

We recommend using Drip-proof Models (protection equivalent to IP62) in locations subject to floating dirt and dust. Other models do not have a protective structure.

Wiring

For wiring, use a wire size that is appropriate for the applied voltage and the supplied current. When soldering the Switch, make sure that the capacity of the soldering iron is 60 W maximum. Do not take more than 5 s to solder any part of the Switch. Using the Switch with incomplete soldering may result in errors and heat, which may cause burning. The characteristics of the Switch will deteriorate if a soldering iron with a capacity of more than 60 W is used or if any part of the Switch is soldered for 6 s or longer.

Tightening

The suitable tightening torque for screw terminals is given below.

- Screw terminals except for those on Split-contact Models (Z-10FY-B): 0.78 to 1.18 N·m
- Screw terminals on Split-contact Models (Z-10FY-B): 0.49 to 1.18 N·m

Operation

- Make sure that the switching speed and frequency are within the specified ranges.

1. If the switching speed is extremely slow, the contacts may not be switched smoothly, which may result in a contact failure or contact welding.

2. If the switching speed is extremely fast, switching shock may damage the Switch prematurely. If the switching frequency is too high, the contacts may not be able to keep up with the speed.

The rated permissible switching speed and frequency indicate the switching reliability of the Switch.

The life of a Switch is determined at the specified switching speed. The life varies with the switching speed and frequency even when they are within the permissible ranges.

Always conduct appropriate durability tests under actual conditions before using a Switch.

- Make sure that the actuator travel does not exceed the permissible OT position. The operating stroke must be set to 70% to 100% of the rated OT.

Panel Mount Switch (Z-15□Q□, Z-01□Q□)

- When mounting the panel mount plunger model with screws on a side surface, be careful of the dog angle and operation speed. Excessive dog angle or operation speed may damage the Switch.
- When using the panel mount plunger model mounted with screws on a side surface, be careful not to apply a large shock. Applying a shock exceeding 1,000 m/s² may damage the Switch.
- When using the panel mount plunger model mounted with screws on a side surface, remove the hexagonal nuts from the actuator.

High-sensitivity Switch (Z-15H)/

Extra-high-sensitivity Switch (Z-15H2)

- When using the Switch in a DC circuit, be sure to provide an arc suppressor as well because the small contact gap of the Switch may result in contact troubles.
- In an application where a high repeat accuracy is required, limit the current that flows through the Switch to within 0.1 A. Also, use a relay to control a high-capacity load if the Switch is connected to such a load. (In this case, the exciting current of the relay coil is the load of the Switch.)
- Do not apply a force of 19.6 N or higher to the pin plunger.
- Exercise care that the environment conditions such as temperature and humidity do not change abruptly.

Micro Load Applicable Range

Using a model for ordinary loads to open or close the contact of a micro load circuit may result in faulty contact. Use models that operate in the following range. However, even when using micro load models within the operating range shown here, if inrush current occurs when the contact is opened or closed, it may increase contact wear and so decrease durability. Therefore, insert a contact protection circuit where necessary.

The minimum applicable load is the N-level reference value. This value indicates the malfunction reference level for the reliability level of 60% (λ_{60}). The equation, $\lambda_{60} = 0.5 \times 10^{-6} / \text{operations}$ indicates that the estimated malfunction rate is less than 1/2,000,000 operations with a reliability level of 60%.

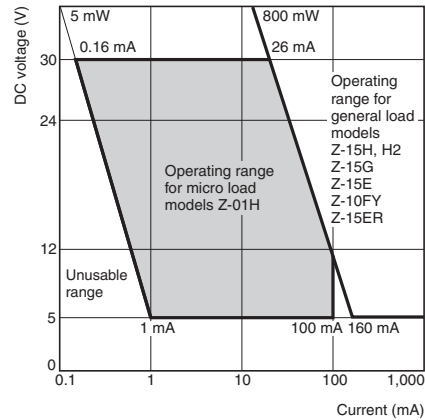

	Z-01H	Z-15□, Z-10FY
Minimum applicable load	1 mA at 5 VDC	160 mA at 5 VDC

Models with Drip-proof Terminal Cover (Z-□A55-B5V) Wiring

- To attach the Protective Cover to the case, hold the cover in almost parallel to the case and then push it to the case. If the cover is pushed diagonally, the rubber packing may slip off, degrading the sealability of the Switch.

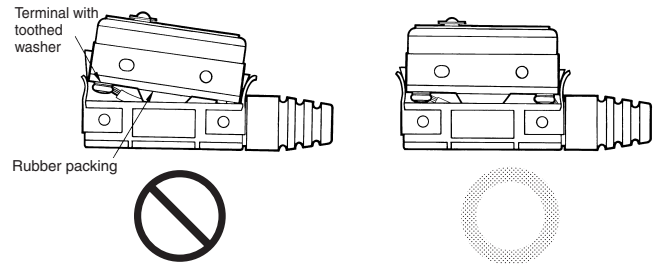

- Use round solderless terminals having the following dimensions to connect leads to the terminals. Tighten the screws of terminals to a torque of 0.78 to 1.18 N·m. Use the terminal shown below.

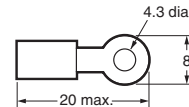

- A cable 8.5 to 10.5 mm in diameter can be applicable to the sealing rubber of the lead outlet of the Switch. A two-core or three-core VCT cable having a cross-sectional area of 1.25 mm² is especially suitable for this.
- M4 small screws with spring toothed washer are used as the terminal screws.

Drip-proof Switch (Z-□55)

- The Switch is not perfectly oil-tight; so do not dip it in oil or water.
- The rubber boots are made from weather-resistive chloroprene rubber.
- Do not use Basic Switches in places with radical changes in temperature.
- Rubber boots and rubber caps will tend to harden at lower ambient temperatures. If an Actuator is used in a pressed state for an extended period of time at low temperatures, it may return slowly or it may not return at all. OMRON can provide special Actuators for use at low temperature with rubber boots or rubber caps made of silicon rubber, which has superior resistance to cold. Ask your OMRON representative for details.

Split-contact Switch (Z-10F□Y)

The applicable current varies depending on how the contacts are used. If the Switch is connected in series, the Switch can endure a current 1.5 to 2 times higher than the current that can be applied in parallel connection.

Flexible Rod Switch (Z-15□NJ□55, Drip-proof)

- When the rod is fully swung, the Switch may operate when the lever returns, causing chattering. Use a circuit that compensates for chattering wherever possible.
- Do not switch the rod to the fullest extent when the Switch is to break a power circuit because such a practice may cause metal deposition to occur between the mating contacts of the Switch.

Other Precautions

- Do not apply excessive force with a screwdriver or other tool when attaching or removing the Protective Cover. Doing so may deform the Switch.

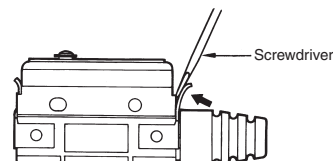

- The Drip-proof Terminal Protective Cover (AP-DV) can be used only with Switches with model numbers ending in “-B5V.”
- The Drip-proof Terminal Protective Cover is only available for maintenance purposes.

Accessories (Order Separately)

Refer to “Z/A/X/DZ Common Accessories” datasheet for details about Terminal Covers, Separators, and Actuators.

**Drip-proof Terminal Cover
(Order Separately)**

The Drip-proof Terminal Protective Cover is provided for maintenance for Z-□A55-B5V Switches.

Ordering Information

Name	Model
Drip-proof Terminal Protective Cover	AP-DV

Dimensions (Unit: mm)

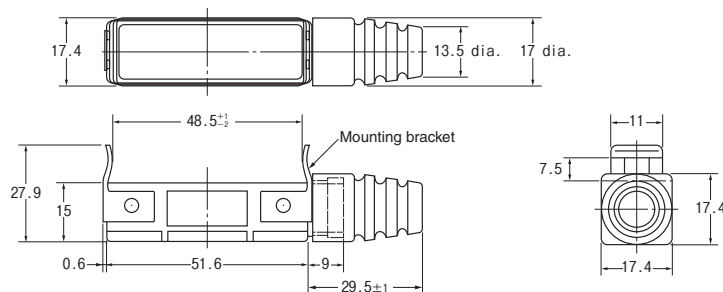

All sales are subject to Omron Electronic Components LLC standard terms and conditions of sale, which can be found at http://www.components.omron.com/components/web/webfiles.nsf/sales_terms.html

ALL DIMENSIONS SHOWN ARE IN MILLIMETERS.
To convert millimeters into inches, multiply by 0.03937. To convert grams into ounces, multiply by 0.03527.

OMRON[®]

**OMRON ELECTRONIC
COMPONENTS LLC**

55 E. Commerce Drive, Suite B
Schaumburg, IL 60173

847-882-2288

OMRON ON-LINE

Global - <http://www.omron.com>

USA - <http://www.components.omron.com>

Cat. No. X303-E-1

11/10

Specifications subject to change without notice

Printed in USA

Mouser Electronics

Authorized Distributor

Click to View Pricing, Inventory, Delivery & Lifecycle Information:

Omron:

[Z-15GQ55](#) [Z-15GW255](#) [Z-15GW2255-B6-106-K](#) [Z-15GW2255M19D1M](#) [Z-15GW2255-M19D3M](#) [Z-](#)
[15GW2255M19L1M](#) [Z-15GW2255M19R1M](#) [Z-15GS55](#) [Z-15GW2255M19D-1M](#) [Z-15GW2255-M19D-3M](#) [Z-](#)
[15GW2255M19L-1M](#) [Z-15GW2255M19R-1M](#) [Z-10FM22Y-B](#) [Z-15GNJ55-MR2 0.5M](#) [Z-15EQ22R-1](#) [Z-15E](#) [Z-15GW21](#)
[Z-15HW7855](#) [Z-15EW565](#) [Z-15G55](#) [Z-10FDY-B](#) [Z-15GQ8](#) [Z-15GW-BT](#) [Z-15GW4455](#) [Z-15H2](#) [Z-15GQ-B74-K](#) [Z-](#)
[15GW32](#) [Z-15GK3A55-B5V](#) [Z-10FW22Y255-B6-105-K1](#) [Z-01HD55-B](#) [Z-01HW2255-B](#) [Z-01H55-B](#) [Z-15GK556-MR](#)
[2M](#)