

RIGOL

Application Note

TX1000 RF Demo Kit

Feb. 2014

RIGOL Technologies, Inc.

Guaranty and Declaration

Copyright

© 2010 RIGOL Technologies, Inc. All Rights Reserved.

Trademark Information

RIGOL is a registered trademark of RIGOL Technologies, Inc.

Publication Number

APD05102-1110

Notices

- **RIGOL** products are protected by patent law in and outside of P.R.C.
- **RIGOL** reserves the right to modify or change parts of or all the specifications and pricing policies at company's sole decision.
- Information in this publication replaces all previously corresponding material.
- **RIGOL** shall not be liable for losses caused by either incidental or consequential in connection with the furnishing, use or performance of this manual as well as any information contained.
- Any part of this document is forbidden to be copied or photocopied or rearranged without prior written approval of **RIGOL**.

Product Certification

RIGOL guarantees this product conforms to the national and industrial standards in China as well as the ISO9001:2008 standard and the ISO14001:2004 standard. Other international standard conformance certification is in progress.

Contact Us

If you have any problem or requirement when using our products or this manual, please contact **RIGOL**.

E-mail: service@rigol.com

Websites: www.rigol.com

Content

Guaranty and Declaration	I
Product Overview.....	1
Hardware Modules	2
To Control TX1000 Using PC Software	3
Software Installation	3
System and Installation Requirements	3
Installation Procedures	3
To Connect TX1000.....	6
To Start the Software	9
Interface Layout	10
To Control TX1000 Using DSA800	12
Typical Applications	13
To Test the Measurement Function of the Spectrum Analyzer	13
To Test the Band-pass Filter Characteristics	14
The Influence of the Performance of Amplifier on the System	15
The Influence of the Performance of Filter on the System	17
Specifications.....	18
Accessories	20

Product Overview

TX1000 RF Demo Kit (hereinafter referred to as TX1000) is a signal emission kit released by **RIGOL** to demonstrate the DSA1000, DSA1000A and DSA800 series spectrum analyzers.

TX1000 features:

- Energized by USB.
- Connected with PC for control through software.
- When connected with DSA800, it can be controlled via the built-in control interface of DSA800 without using the PC.
- Provide 10 MHz reference signal output for easy clock synchronization with other devices.
- Built-in 50 MHz signal which can be connected to the input port by “switches” to be used for the learning, operation and demonstration of the spectrum analyzer.
- Provide 500 MHz and 1 GHz local oscillator signal outputs.
- Modular circuit design; provide interfaces for users to make separate measurement of any component; enable to replace any component.

Hardware Modules

The appearance of TX1000 is as shown in Figure 1. The hardware modules of TX1000 include the mixer, filter and amplifier. The schematic diagram is as shown in Figure 2.



Figure 1 TX1000 Appearance

- USB port: used to connect the PC or spectrum analyzer (provide power for the modules and control the modules).
- J1, J4, J6, J8: signal input terminal.
- J3, J5, J7, J10: output RF signal.
- J11: output 500 MHz local oscillator signal.
- J12: input external local oscillator signal.
- J13: output 1 GHz local oscillator signal.
- J14: output 10 MHz reference signal.

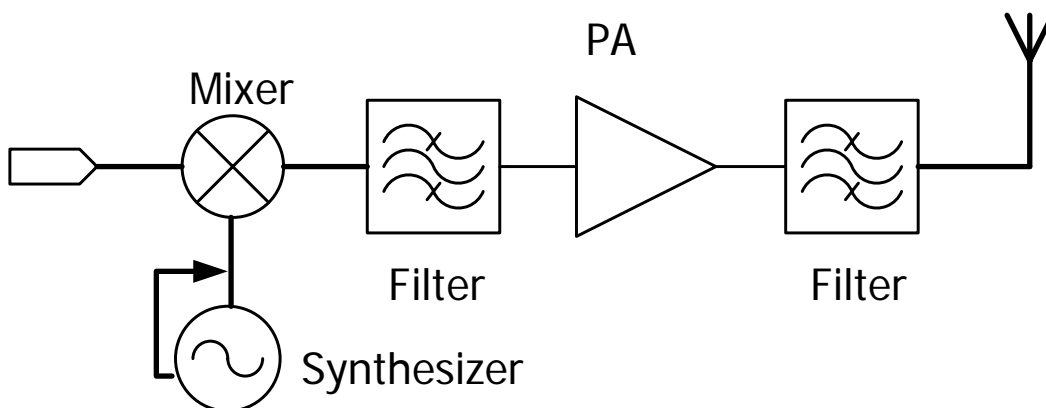

Figure 2 TX1000 Schematic Diagram

To Control TX1000 Using PC Software

Software Installation

When using TX1000 with the PC, you have to install the PC control software of TX1000.

System and Installation Requirements

1. Hardware Configuration Requirements

- Processor: 1 GHz and greater
- Memory: 500 MB and greater
- Display: 1024×768 or higher resolution
- Hard Disk: 200 MB and greater

2. Running Environment

- Operation System: Windows XP (32-bit), Windows 7 (32-bit), Windows Vista (32-bit)
- PC administrator privileges: use the administrator account to log into the PC
- The **RIGOL** common PC software (Ultra Sigma 00.01.05.05 or higher version) has been installed.

Installation Procedures

1. Before installing the software, install Ultra Sigma 00.01.05.05 or higher version. For the installation procedures, refer to the related manual of Ultra Sigma.
2. **RIGOL** provides the installation package (in the CD in the product package) of the PC control software of TX1000. Double-click the **TX1000 setup.exe** file to enter the interface as shown in the figure below and follow the instructions to finish the installation.



- 3. Click "Next" and the installation process is as shown in the figure below.

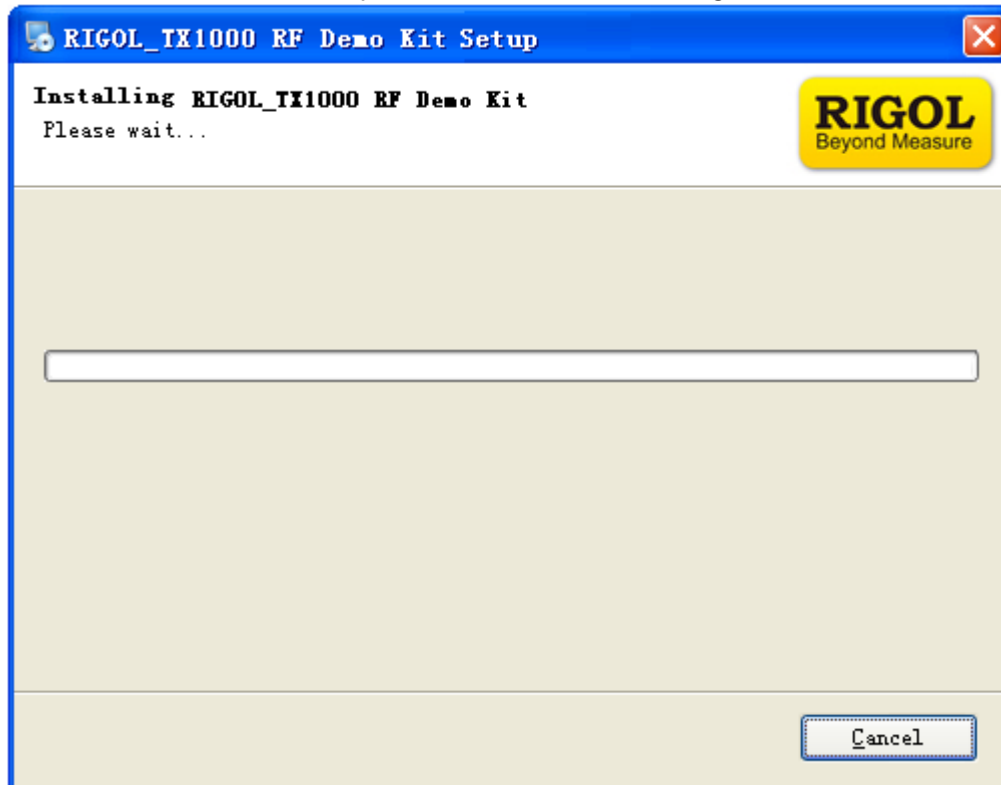

- 4. The installation process finishes as shown in the figure below. At this point, you have successfully installed the PC control software of TX1000 and the shortcut named "TX1000 RF Demo Kit" is displayed on the desktop.



To Connect TX1000

Connect TX1000 and the PC using USB cable. At this point, the “New Hardware Wizard” is displayed on the PC. Please install the “USB Test and Measurement Device” driver following the instructions in the wizard.

The steps are as follows:

1. Select “Install from a list or specific location (Advanced)” and click “Next”;

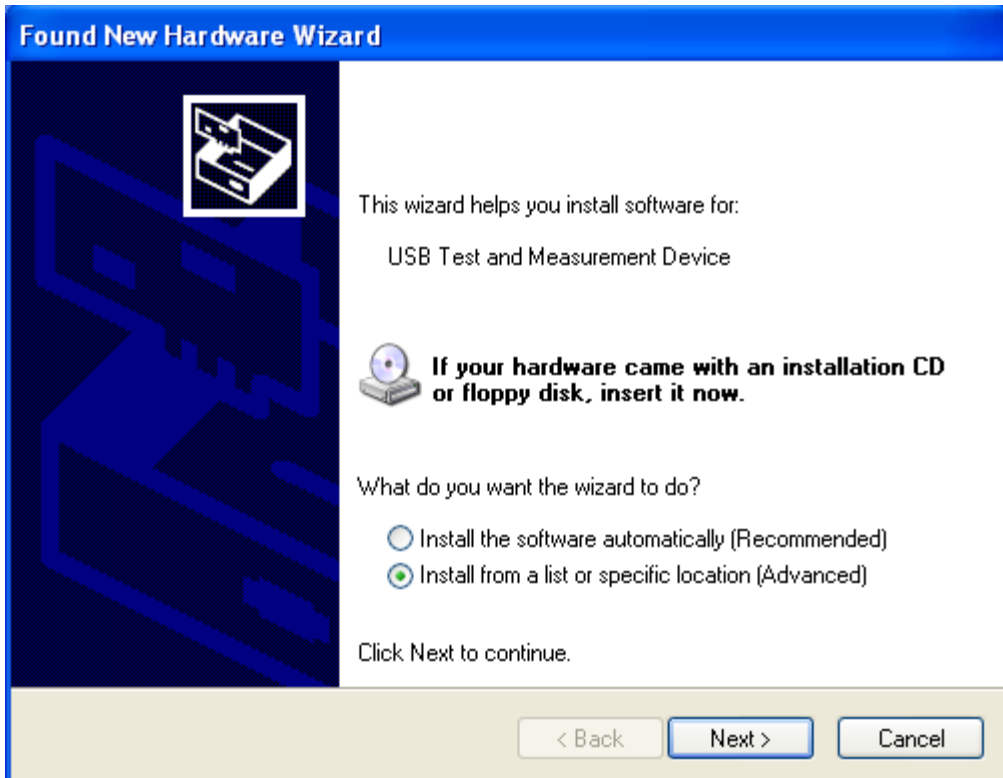

2. Select "Don't search. I will choose the driver to install" and click "Next";

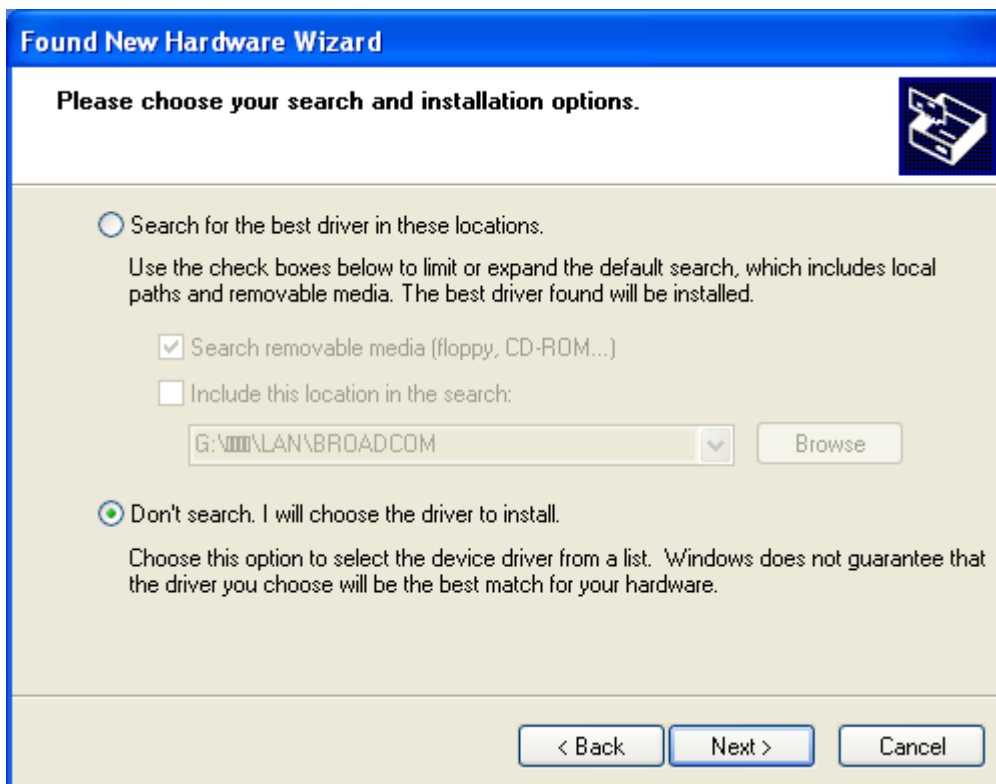

3. Select "USB Test and Measurement Device" and click "Next";

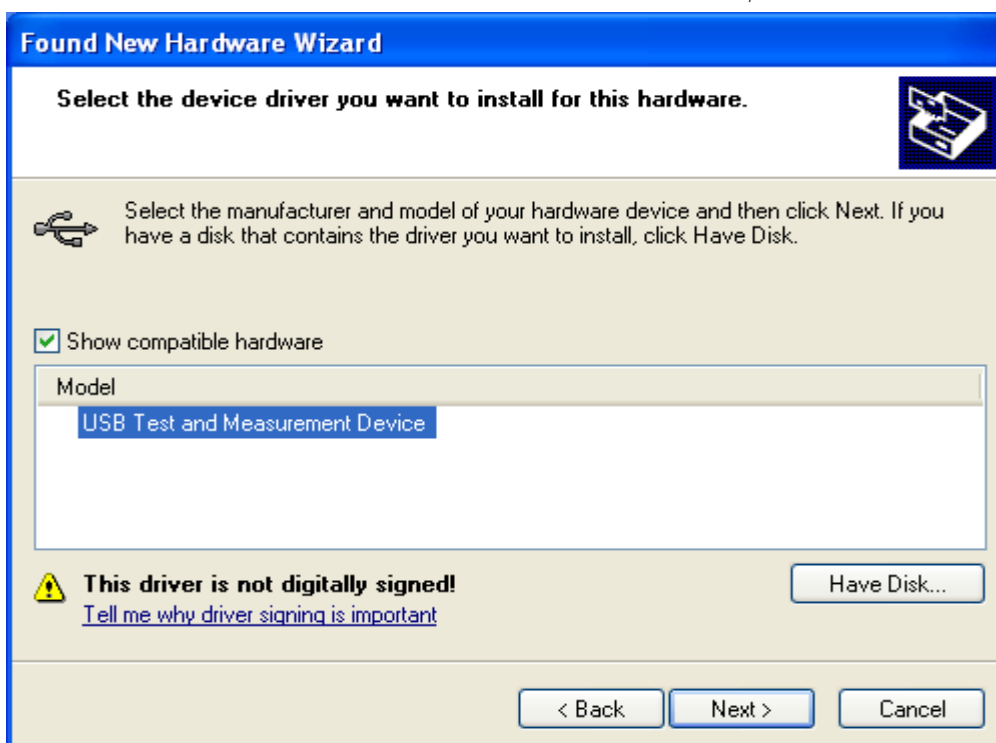

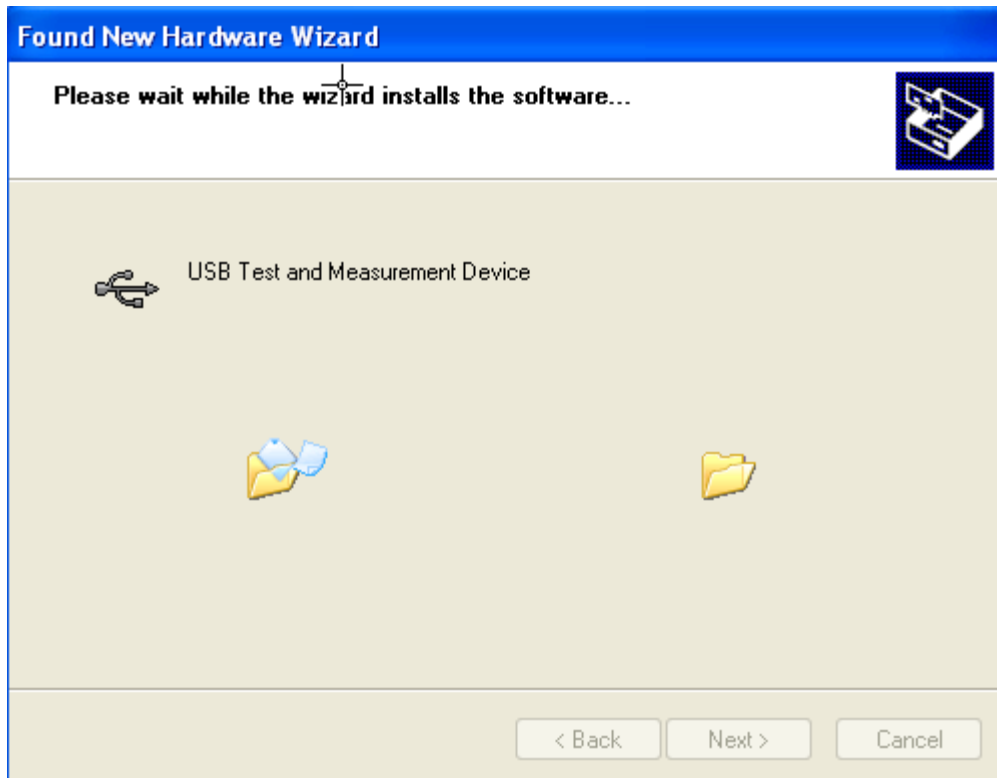

4. Click "Finish" after the installation is finished.



To Start the Software

After the PC control software of TX1000 is successfully installed, you can start the software via the following two methods.

1. Via the [Start] menu or the shortcut on the desktop

Click [Start] → [All Programs] → [RIGOL Technologies, Inc] → [TX1000 RF Demo Kit] → [TX1000 RF Demo Kit] or double-click the shortcut named "TX1000 RF Demo Kit" on the desktop to enter the software interface.

Note: the communication between the software and TX1000 can not be built automatically via this method (even when the TX1000 is connected to the PC). The connection status is  when the software is started. You need to build the communication between the software and TX1000 manually by referring to the introductions in "**Interface Layout**".

2. Via Ultra Sigma

- Connect TX1000 with the PC using the USB cable provided with the accessories;
- Start the Ultra Sigma and search for the TX1000 connected;
- As shown in the figure below, right-click the resource name of the TX1000 connected and select "TX1000 RF Demo Kit" to enter the software interface.

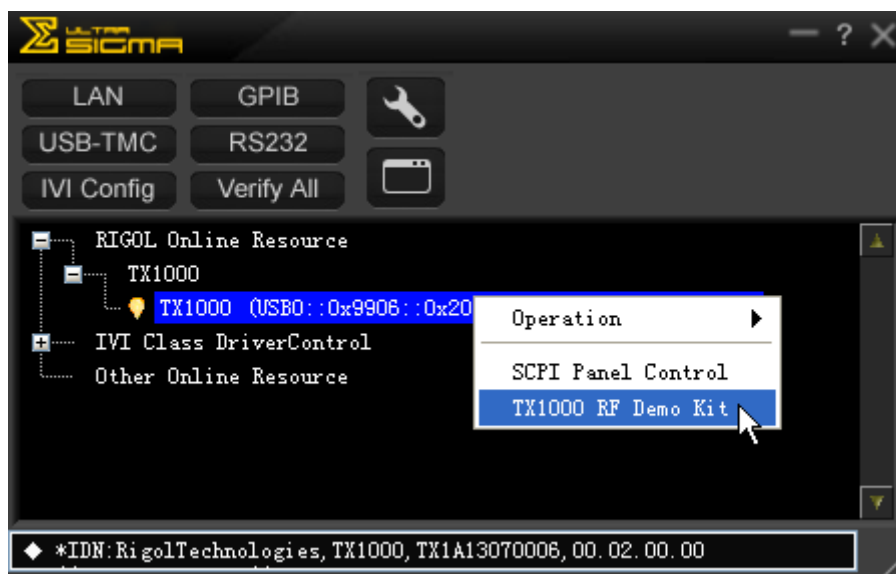



Figure 3 Start the Software via Ultra Sigma

Note: the communication between the software and TX1000 can be built automatically via this method (make sure that your PC has been connected with TX1000). The connection status is  when the software is started.

Interface Layout

The interface of the PC control software of TX1000 is as shown in the figure below.

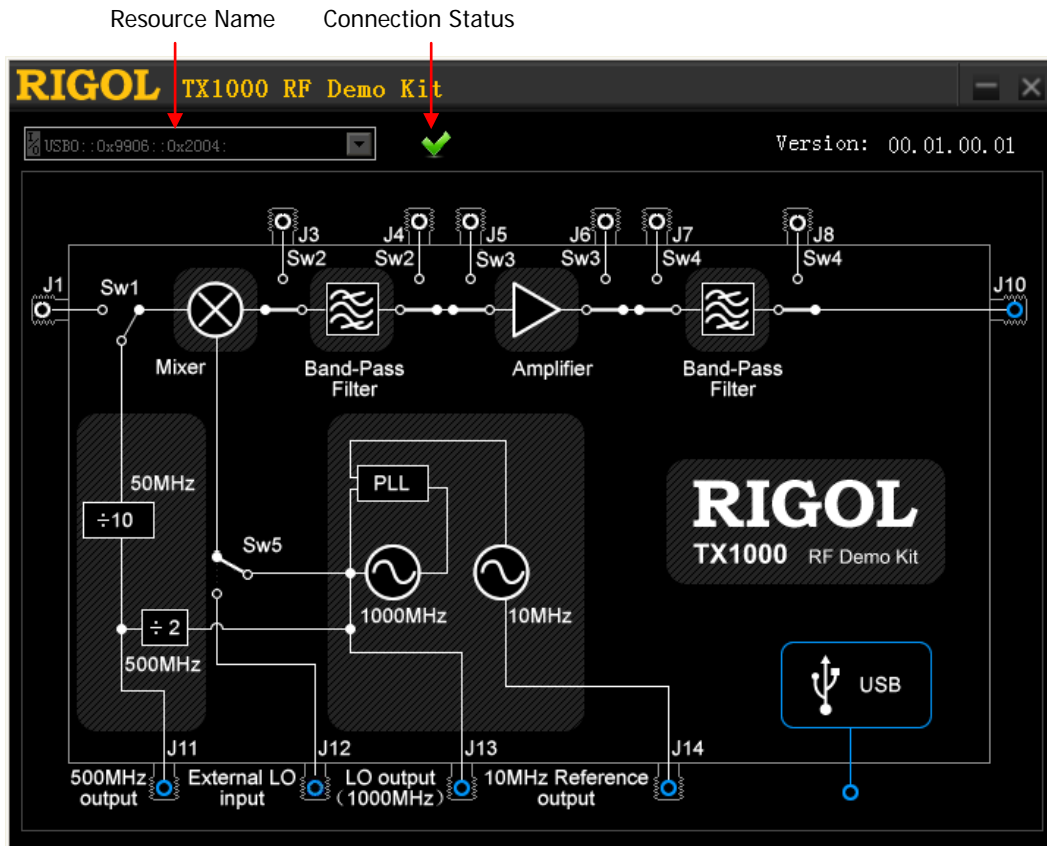



Figure 4 Interface Layout of the PC Control Software

1. Resource Name and Connection Status

When starting the software via Ultra Sigma, the software displays the resource name automatically and the dropdown box is grayed out and disabled. At this point, the connection status is  denoting that the connection is successful. When starting the software via the

[Start] menu or shortcut on the desktop, the connection status is ; you need to click the dropdown box and select the resource name of the TX1000 connected to build the communication between the software and TX1000 manually. It takes some time (several seconds) for the software to search the resources and please wait for the resource list patiently. When multiple devices are connected to the PC, the resource names of all the devices will be displayed in the dropdown list and please select the resource name started with USB0::0x9906::0x2004 (all the resource names of TX1000 start with this character string).



2. Control Switches

After the software and TX1000 are successfully connected, you can control TX1000 via the software interface. There are five switches (Sw1, Sw2, Sw3, Sw4 and Sw5) on the software interface and you can click the corresponding switch to control its state.

- Sw1: when J1 is connected, connect the signal input from the J1 terminal; when J1 is disconnected, connect the built-in 50 MHz signal.
- Sw2: when J3 and J4 are connected, output signal from J3 or connect the signal input from the J4 terminal; when J3 and J4 are disconnected, perform band-pass filtering on the signal passing through the mixer.
- Sw3: when J5 and J6 are connected, output signal from J5 or connect the signal input from the J6 terminal; when J5 and J6 are disconnected, amplify the signal passing through the band-pass filter or the signal input from the J4 terminal.
- Sw4: when J7 and J8 are connected, output signal from J7 or connect the signal input from the J8 terminal; when J7 and J8 are disconnected, perform band-pass filtering on the signal passing through the amplifier or the signal input from the J6 terminal and then output it via J10.
- Sw5: when J12 is connected, connect the external local oscillator signal input from the J12 terminal; when J12 is disconnected, connect the internal 1 GHz local oscillator signal.

To Control TX1000 Using DSA800

When using TX1000 with the DSA800 series, you can control TX1000 using the built-in control interface of DSA800 without using the PC and PC control software.

1. Connect TX1000 and DSA800 using the USB cable provided with the accessories.
2. Press **System** at the front panel of DSA800 and press  to open the second page menu. Press **TX1000** to open the control interface as shown in the figure below.

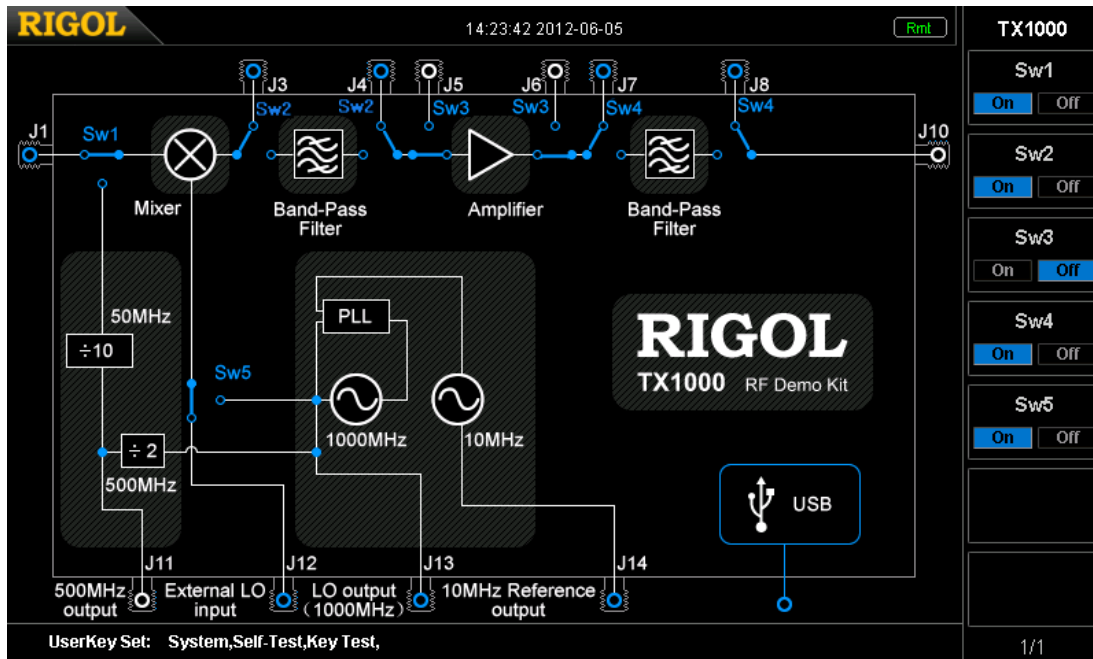

Figure 5 Built-in TX1000 Control Interface of DSA800

3. You can use the menu at the right to control the state of the five switches respectively.

Typical Applications

To Test the Measurement Function of the Spectrum Analyzer

Operation Steps:

1. Connect the PC and TX1000 using USB cable and connect J10 of TX1000 and the RF input terminal of the spectrum analyzer using N-SMA cable as shown in Figure 6;

Explanation: when using the DSA800 series spectrum analyzer, you can connect the DSA800 and TX1000 using USB cable without using the PC.

2. Configure the status of each switch via the control interface.

Switch	PC Control Software Status	DSA800 Control Interface Status
Sw1	Disconnect J1 and connect the built-in 50 MHz signal	Off
Sw2	Disconnect J3 and J4	Off
Sw3	Disconnect J5 and J6	Off
Sw4	Disconnect J7 and J8	Off
Sw5	Disconnect J12	Off

3. Set the measurement parameters on the spectrum analyzer to get the measurement results.



Figure 6 Test the Measurement Function of the Instrument

To Test the Band-pass Filter Characteristics

Explanation: the application introduced here is only applicable to spectrum analyzers with the tracking generator function.

Operation Steps:

1. Connect the PC and TX1000 using USB cable, connect J6 of TX1000 and the output terminal of the tracking generator of the spectrum analyzer using the N-SMA cable and connect J10 of TX1000 and the RF input terminal of the spectrum analyzer using N-SMA cable as shown in Figure 7;

Explanation: when DSA800 series spectrum analyzer is used, you can connect DSA800 and TX1000 using USB cable without using the PC.

2. Set the tracking generator parameters on the spectrum analyzer: turn on the tracking generator and set the parameters such as the TG Level;
3. Configure the status of each switch via the control interface.

Switch	PC Control Software Status	DSA800 Control Interface Status
Sw1	Ignore	Ignore
Sw2	Ignore	Ignore
Sw3	Connect J5 and J6	On
Sw4	Disconnect J7 and J8	Off
Sw5	Ignore	Ignore

4. Set the measurement parameters on the spectrum analyzer to get the measurement results.



Figure 7 Test the Band-pass Filter Characteristics

The Influence of the Performance of Amplifier on the System

Operation steps:

1. Connect the PC and TX1000 using USB cable, connect J10 of TX1000 and the RF input terminal of the spectrum analyzer using N-SMA cable and connect the amplifier to J5 and J6 using two SMA-SMA cables (to replace the internal amplifier of TX1000) as shown in Figure 8;

Explanation: when DSA800 series spectrum analyzer is used, you can connect DSA800 and TX1000 using USB cable without using the PC.

2. Configure the status of each switch via the control interface.

Switch	PC Control Software Status	DSA800 Control Interface Status
Sw1	Disconnect J1 and connect the built-in 50 MHz signal	Off
Sw2	Disconnect J3 and J4	Off
Sw3	Connect J5 and J6	On
Sw4	Disconnect J7 and J8	Off
Sw5	Disconnect J12	Off

3. Set the measurement parameters on the spectrum analyzer to get the measurement results.

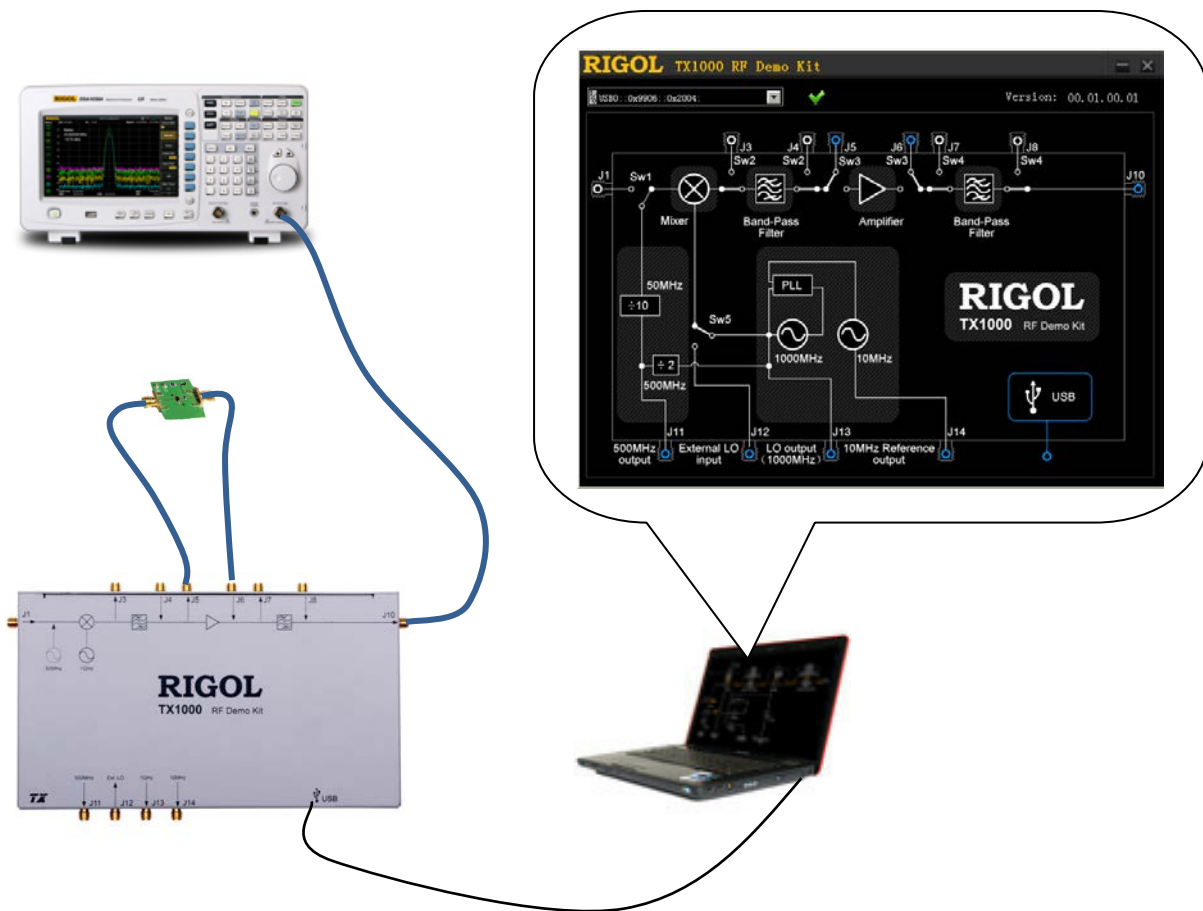

Figure 8 The Influence of the Performance of Amplifier on the System

The Influence of the Performance of Filter on the System

Operation Steps:

1. Connect the PC and TX1000 using USB cable, connect J10 of TX1000 and the RF input terminal of the spectrum analyzer using N-SMA cable and connect the filter to J7 and J8 using two SMA-SMA cables (to replace the internal filter of TX1000) as shown in Figure 9;

Explanation: when DSA800 series spectrum analyzer is used, you can connect DSA800 and TX1000 using USB cable without using the PC.

2. Configure the status of each switch via the control interface.

Switch	PC Control Software Status	DSA800 Control Interface Status
Sw1	Disconnect J1 and connect the built-in 50 MHz signal	Off
Sw2	Disconnect J3 and J4	Off
Sw3	Disconnect J5 and J6	Off
Sw4	Connect J7 and J8	On
Sw5	Disconnect J12	Off

3. Set the measurement parameters on the spectrum analyzer to get the measurement results.

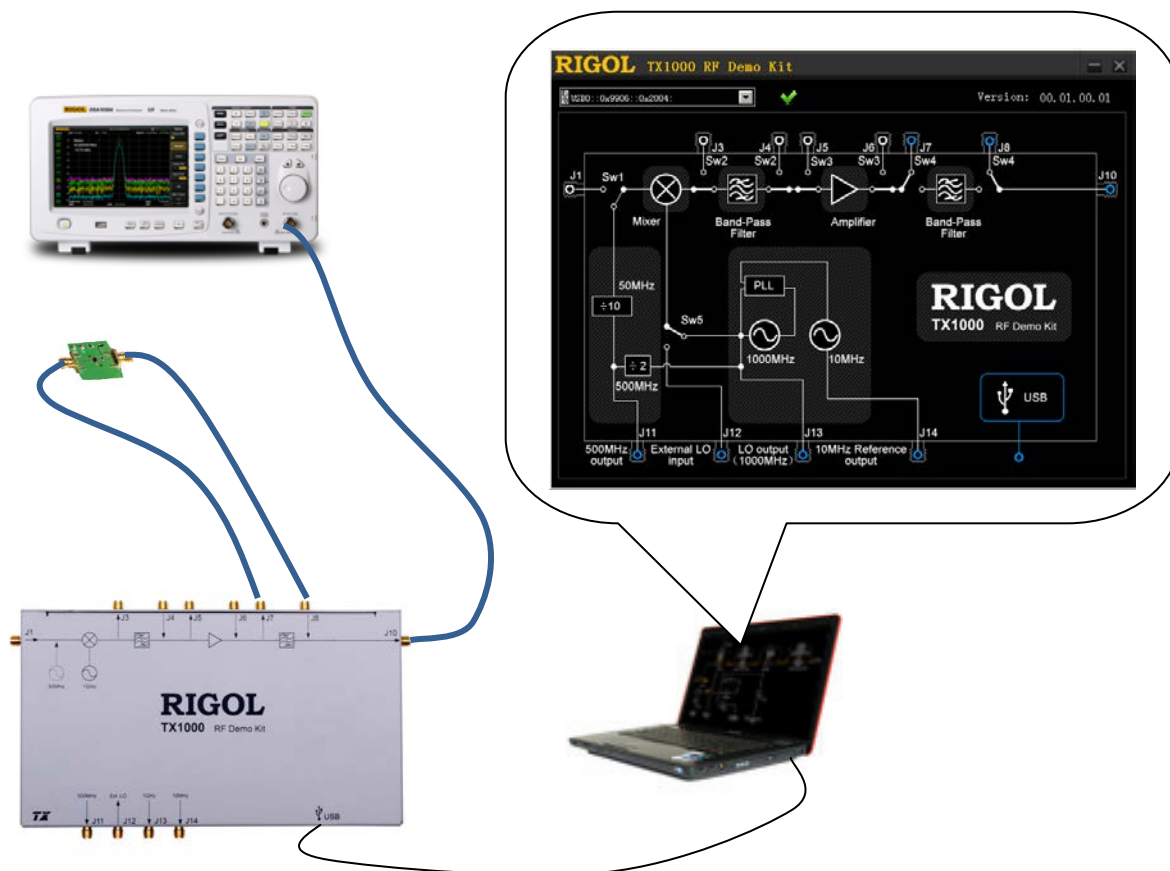

Figure 9 The Influence of the Performance of the Filter on the System

Specifications

This section lists the specifications of TX1000. The specifications can be guaranteed under the following conditions: the temperature range is from 0°C to 45°C; the instrument has been warmed up for at least 30 minutes.

Parameters	Explanation
Input Port	
Input Frequency (Standard) (Expansion)	50 MHz \pm 10 MHz 10 MHz to 1000 MHz
Input Power	\leq 0 dBm
Output Port	
Output Frequency (Standard) (Expansion)	950 MHz \pm 10 MHz DC to 1000 MHz
Output Power	+3 dBm \pm 2 dB
Internal Local Oscillator Output	
Output Frequency	1000 MHz
Phase Noise	-98 dBc/Hz@10 kHz, Typical
Output Power	-17 dBm \pm 2 dB
Reference Frequency	
Frequency	10 MHz
Temperature Stability	\pm 1 ppm (0°C to 45°C)
Aging Rate	\pm 1 ppm/year
Output Power	+3 dBm \pm 2 dB
Distortion	
SHI	+40 dBm
IP3	+20 dBm
P1dB	+5 dBm
Mixer	
RF/LO Input Frequency Range	50 MHz to 1000 MHz
IF Output Frequency Range	DC to 1000 MHz
Local Oscillator Drive Power	+7 dBm
Insertion Loss	8 dB (Maximum)
Band-pass Filter	
Center Frequency	950 MHz
1dB Bandwidth	30 MHz
Insertion Loss	3.2 dB (Typical), 4.0 dB (Maximum)
In-band Flatness	0.8 dB (Typical), 1.5 dB (Maximum)
Restrain at Center Frequency \pm 40 MHz	>40 dB
Amplifier	
Working Frequency	DC to 2 GHz

Gain	20 dB (Typical)
P1dB	9.8 dBm
NF	3.3 dB
USB Interface	
Port	B Socket
Protocol	1.1 Version
Environment Temperature	
Working Temperature	0°C to 45°C
Storage Temperature	-20°C to 70°C
Relative Humidity	<95%
Others	
Connector Type	SMA (JACK)
Port Input/output Impedance	50 Ω
Power Consumption	1.5 W
Dimension	225 mm × 132.5 mm × 25.5 mm
Weight	0.7 kg

Accessories

Name	Specification&Quantity
TX1000 RF Demo Kit	1
USB Cable	1.5 m, 1
SMA-SMA Cable	100 mm, 3
N-SMA Cable	500 mm, 2
CD	Include PC control software installation program and application note, 1
Kit Package	1

To order the above accessories, please contact **RIGOL**.