

Features

1 Pole - 6 A electromechanical relay interface modules, 6.2 mm wide.

Ideal interface for PLC and electronic systems

- Sensitive DC coil or AC/DC coil versions
- Integral coil indication and protection circuit
- Instant ejection of relay using plastic retaining clip
- UL Listed
- 35 mm rail (EN 50022) mounting

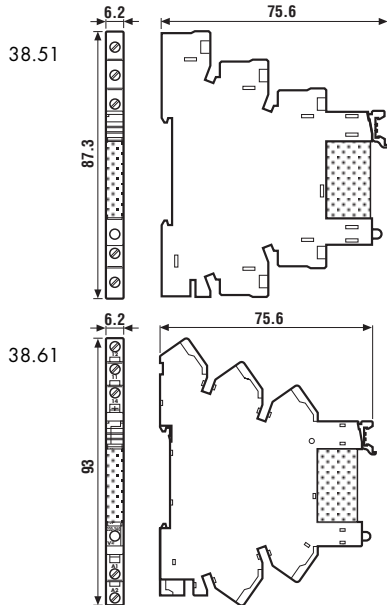

38.51



- Screw terminal
- 1 pole electromechanical relay
- 35 mm rail mounting

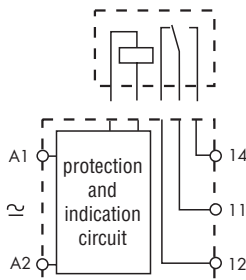

38.61



- Screwless terminal
- 1 pole electromechanical relay
- 35 mm rail mounting

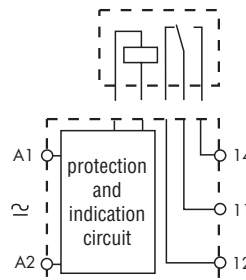

38.51.3 / 38.61.3



- Leakage current suppression
- 1 pole electromechanical relay
- 35 mm rail mounting

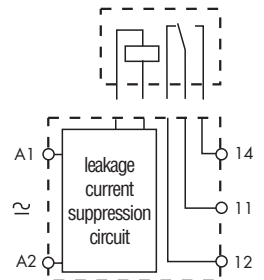

Contact specification		38.51	38.61	38.51.3 / 38.61.3
Contact configuration		1 CO (SPDT)	1 CO (SPDT)	1 CO (SPDT)
Rated current/Maximum peak current	A	6/10	6/10	6/10
Rated voltage/Maximum switching voltage V AC		250/400	250/400	250/400
Rated load AC1	VA	1,500	1,500	1,500
Rated load AC15 (230 V AC)	VA	300	300	300
Single phase motor rating (230 V AC)	kW	0.185	0.185	0.185
Breaking capacity DC1: 30/110/220 V	A	6/0.2/0.15	6/0.2/0.15	6/0.2/0.15
Minimum switching load	mW (V/mA)	500 (12/10)	500 (12/10)	500 (12/10)
Standard contact material		AgNi	AgNi	AgNi
Coil specification		38.51	38.61	38.51.3 / 38.61.3
Nominal voltage (U _N)	V AC/DC	12 - 24 - 48 - 60 - (110...125) - (220...240)	12 - 24 - 48 - 60 - (110...125) - (220...240)	(110...125) (230...240)AC only
	V DC	6 - 12 - 24 - 48 - 60 (non polarized)	6 - 12 - 24 - 48 - 60 (non polarized)	—
Rated power AC/DC	VA (50 Hz)/W	see page 121	see page 121	1/1 0.5/—
Operating range	AC/DC	(0.8...1.1)U _N	(0.8...1.1)U _N	(94...138)U _N (184...264)U _N
	DC	(0.8...1.2)U _N	(0.8...1.2)U _N	—
Holding voltage	AC/DC	0.6 U _N / 0.6 U _N	0.6 U _N / 0.6 U _N	0.6 U _N / 0.6 U _N
Must drop-out voltage	AC/DC	0.1 U _N / 0.05 U _N	0.1 U _N / 0.05 U _N	44 V 92 V
Technical data		38.51	38.61	38.51.3 / 38.61.3
Mechanical life	cycles	10 · 10 ⁶	10 · 10 ⁶	10 · 10 ⁶
Electrical life at rated load AC1	cycles	60 · 10 ³	60 · 10 ³	60 · 10 ³
Operate/release time	ms	5/6	5/6	5/6
Insulation between coil and contacts (1.2/50 μs)	kV	6 (8 mm)	6 (8 mm)	6 (8 mm)
Dielectric strength between open contacts	V AC	1,000	1,000	1,000
Ambient temperature range (≤ 60 V / > 60 V)	°C	-40...+70 / -40...+55	-40...+70 / -40...+55	— / -40...+55
Protection category		IP 20	IP 20	IP 20
Approvals relay (according to type)				





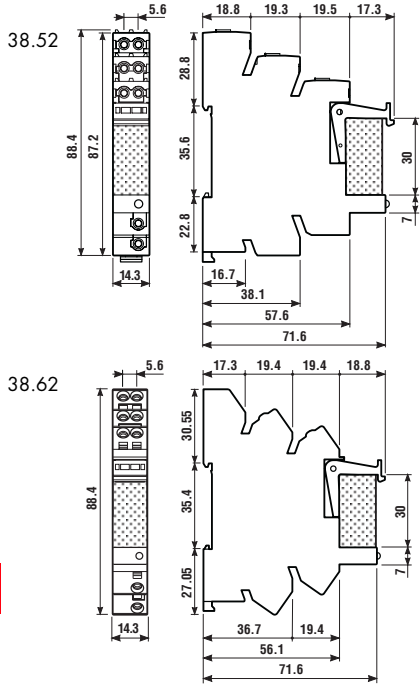

Features

2 Pole - 8 A electromechanical relay interface modules, 14 mm wide.

Ideal interface for PLC and electronic systems

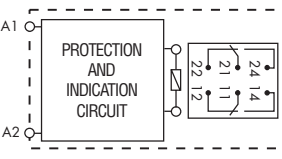
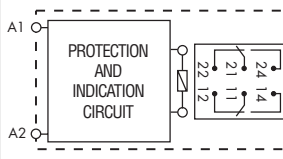
- Sensitive DC coil versions
- Integral coil indication and protection circuit
- Instant ejection of relay using plastic retaining clip
- 35 mm rail (EN 50022) mounting



	38.52	38.62
		
	<ul style="list-style-type: none"> • Screw terminal • 2 pole electromechanical relay • 35 mm rail mounting 	<ul style="list-style-type: none"> • Screwless terminal • 2 pole electromechanical relay • 35 mm rail mounting
		
Contact specification		
Contact configuration	2 CO (DPDT)	2 CO (DPDT)
Rated current/Maximum peak current A	8/15	8/15
Rated voltage/Maximum switching voltage V AC	250/400	250/400
Rated load AC1 VA	2,000	2,000
Rated load AC15 (230 V AC) VA	400	400
Single phase motor rating (230 V AC) kW	0.3	0.3
Breaking capacity DC1: 30/110/220 V A	8/0.3/0.12	8/0.3/0.12
Minimum switching load mW (V/mA)	300 (5/5)	300 (5/5)
Standard contact material	AgNi	AgNi
Coil specification		
Nominal voltage (U _N) V AC/DC	—	—
V DC	12 - 24 - 60	12 - 24 - 60
Rated power AC/DC VA (50 Hz)/W	—/0.5	—/0.5
Operating range AC/DC	—	—
DC	(0.8...1.2)U _N	(0.8...1.2)U _N
Holding voltage AC/DC	— / 0.6 U _N	— / 0.6 U _N
Must drop-out voltage AC/DC	— / 0.05 U _N	— / 0.05 U _N
Technical data		
Mechanical life cycles	30 · 10 ⁶	30 · 10 ⁶
Electrical life at rated load AC1 cycles	80 · 10 ³	80 · 10 ³
Operate/release time ms	—	—
Insulation between coil and contacts (1.2/50 μs) kV	6 (8 mm)	6 (8 mm)
Dielectric strength between open contacts V AC	1,000	1,000
Ambient temperature range °C	-40...+70	-40...+70
Protection category	IP 20	IP 20
Approvals relay (according to type)	  	

Features

Single output - solid state relay interface modules, 6.2 mm wide

Ideal interface for PLC and electronic systems

- DC, AC or AC/DC input versions
- Supplied with integral coil indication and protection circuit
- Silent, high switching speed and long electrical life
- Instant ejection of relay using plastic retaining clip
- UL listed
- 35 mm rail (EN 50022) mounting

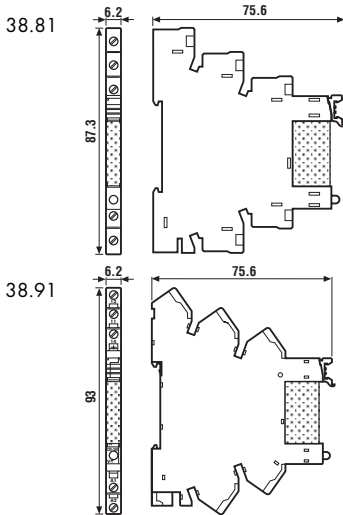

38.81/38.91



- AC or DC output switching
- SSR relay - DC input voltage
- 35 mm rail mounting

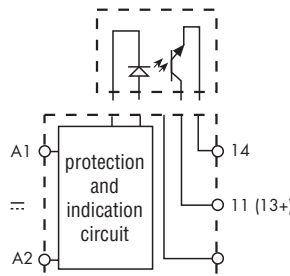

38.81.3/38.91.3



- AC or DC output - Leakage current suppression
- SSR relay - AC or AC/DC input voltage
- 35 mm rail mounting

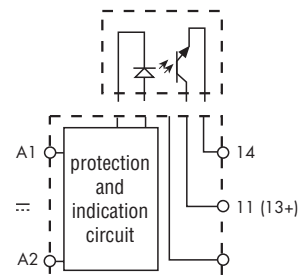

Output circuit

Rated current/Maximum peak current (10 ms)	A	2/20	0.1/0.5	2/40	2/20	0.1/0.5	2/40
Rated voltage/Maximum blocking voltage	V	24/33 DC	48/60 DC	240/275 AC	24/33 DC	48/60 DC	240/275 AC
Switching voltage range	V	(1.5...24)DC	(1.5...48)DC	(12...240)AC	(1.5...24)DC	(1.5...48)DC	(12...240)AC
Minimum switching current	mA	1	0.05	22	1	0.05	22
Max. "OFF-state" leakage current	µA	0.001	0.001	1.5	0.001	0.001	1.5
Max. "ON-state" voltage drop	V	0.12	1	1.6	0.12	1	1.6

Input circuit

Nominal voltage (U _N)	V AC	—			230...240		
	V DC	6 - 24 - 60			—		
	V AC/DC	(110...125) - (220...240)			110...125		
Operating range	V DC	See table page 122			See table page 122		
Control current	mA	See table page 122			See table page 122		
Release voltage	V DC	See table page 122			See table page 122		
Impedance	Ω	See table page 122			See table page 122		

Technical data

Operate/release time	µs	0.1/0.4	0.02/0.11	12/12	0.1/0.4	0.02/0.11	12/12
Dielectric strength between input/output	V	2,500			2,500		
Ambient temperature range	°C	-20...+55			-20...+55		
Environmental protection		IP20			IP20		

Approvals (according to type)



Electromechanical Relay

Ordering information

Electromechanical relay 1 Pole

Example: 38 series relay interface module, 1 CO (SPDT), 12 V DC coil.

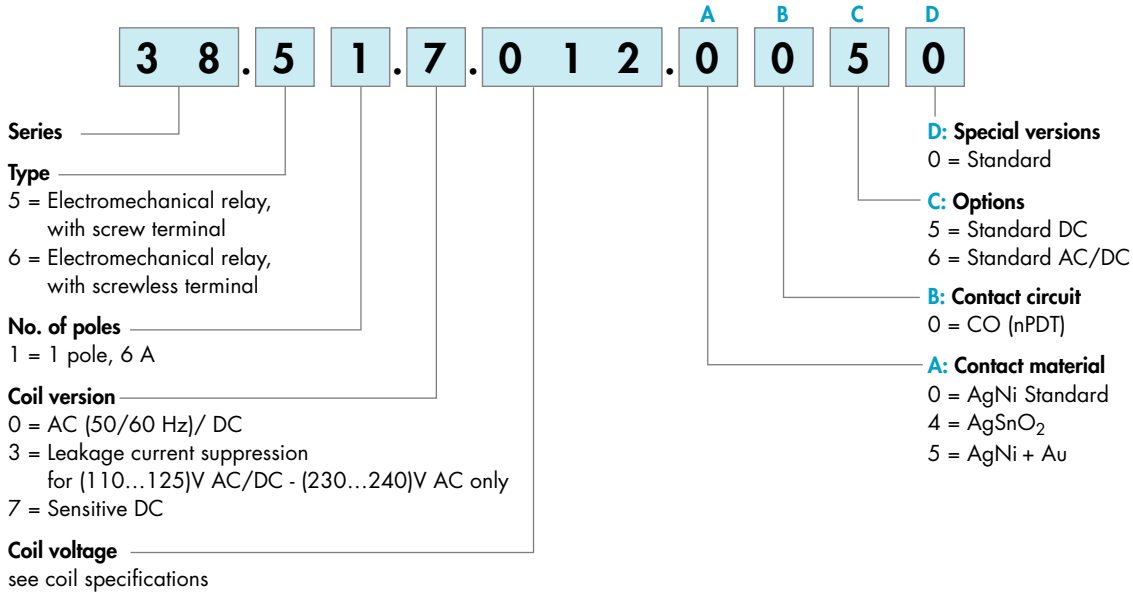

38

Electromechanical relay 2 Pole

Example: 38 series relay interface module, 2 CO (DPDT), 12 V DC coil.

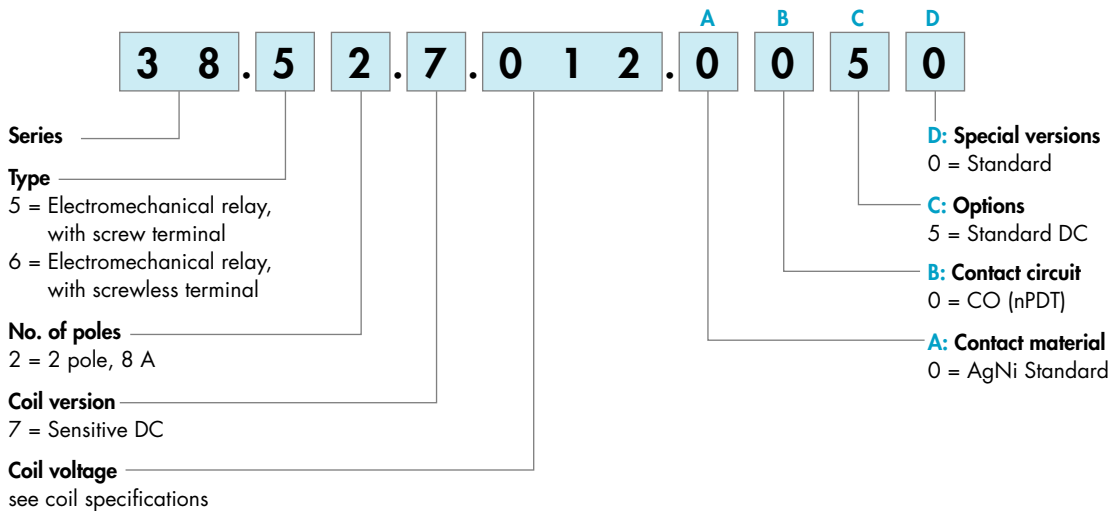

Solid State Relay

Ordering information

Solid state relay

Example: 38 series SSR relay interface module, 2 A, 24 V DC supply.

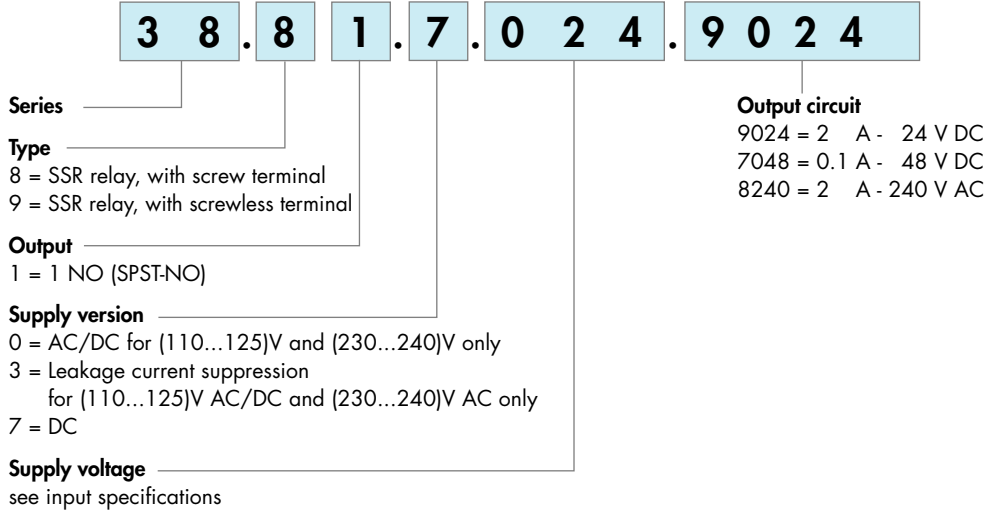

Electromechanical Relay

Technical data

Insulation				
Insulation according to EN 61810-1 ed. 2	insulation rated voltage	V	250	400
	rated impulse withstand voltage	kV	4	4
	pollution degree		3	2
	overvoltage category		III	III
Insulation between coil and contacts (1.2/50 μs)		kV	6 (8 mm)	
Dielectric strength between open contacts		V AC	1,000	
Conducted disturbance immunity				
Burst (5...50)ns, 5 kHz, on A1 - A2			EN 61000-4-4	level 4 (4 kV)
Surge (1.2/50 μs) on A1 - A2 (differential mode)			EN 61000-4-5	level 3 (2 kV)
Other data				
			1 Pole	2 Pole
Bounce time: NO/NC	ms		1/6	2/5
Vibration resistance (10...55)Hz, max. ± 1 mm: NO/NC	g/g		10/5	15/2
Power lost to the environment	without contact current	W	0.2 (12 V) - 0.9 (240 V)	0.5
	with rated current	W	0.5 (12 V) - 1.5 (240 V)	1.3
			38.51/52	38.61/62
Wire strip length	mm		10	10
⊖ Screw torque	Nm		0.5	—
Max. wire size			solid cable	stranded cable
		mm ²	1x2.5/2x1.5	1x2.5/2x1.5
		AWG	1x14/2x16	1x14/2x16
			solid cable	stranded cable
			1x2.5	1x2.5
			1x14	1x14

38

Contact specification

F 38 - Electrical life (AC) v contact current, 1 Pole

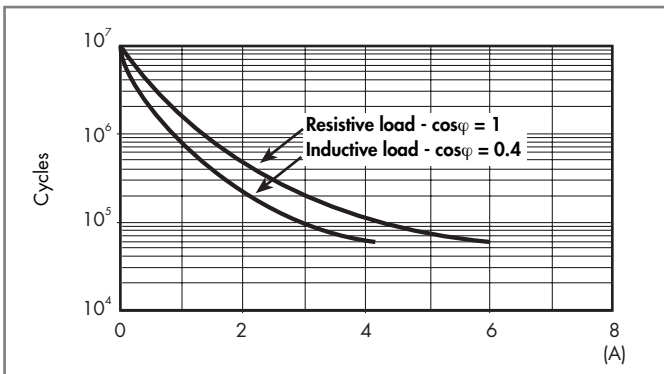

H 38 - Maximum DC1 breaking capacity, 1 Pole

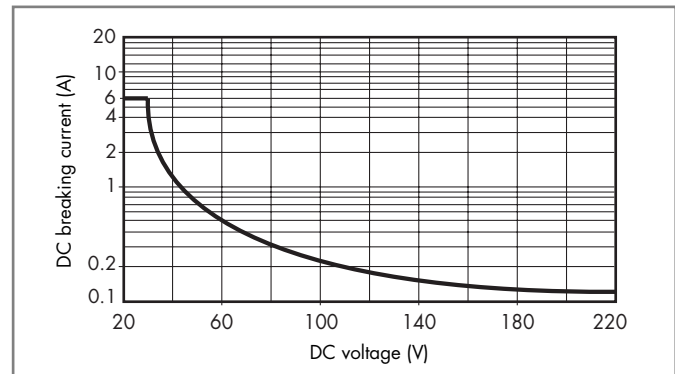

F 38 - Electrical life (AC) v contact current, 2 Pole

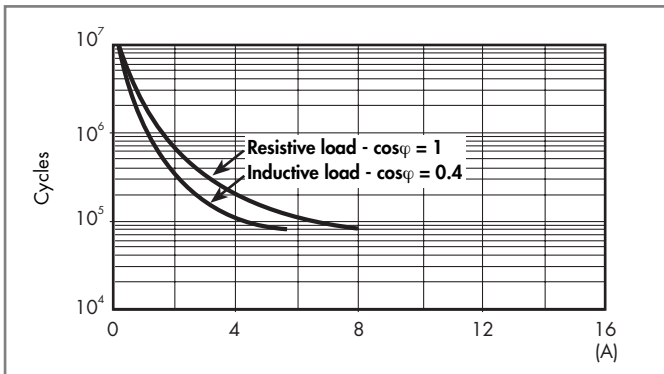

H 38 - Maximum DC1 breaking capacity, 2 Pole

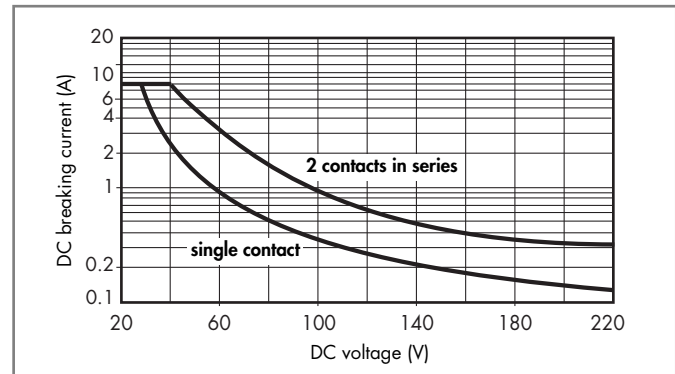

- When switching a resistive load (DC1) having voltage and current values under the curve, an electrical life of $\geq 60 \cdot 10^3$ (1 Pole) or $\geq 80 \cdot 10^3$ (2 Pole) can be expected.
- In the case of DC13 loads, the connection of a diode in parallel with the load will permit a similar electrical life as for a DC1 load. Note: the release time for the load will be increased.

Electromechanical Relay 1 Pole

Coil specifications

Coil data AC/DC, 1 Pole

Nominal voltage U_N	Coil code	Operating range		Rated coil consumption I at U_N	Power consumption P at U_N
		U_{min}	U_{max}		
V		V	V	mA	W
12	0.012	9.8	13.2	16	0.2
24	0.024	19.2	26.4	12	0.2
48	0.048	38.4	52.8	6.9	0.3
60	0.060	48	66	7	0.5
110...125	0.125	88	138	5(*)	0.6(*)
220...240	0.240	184	264	4(*)	0.9(*)

(*) Rated coil consumption and power consumption values relate to $U_N = 125$ and 240 V.

Coil data sensitive DC, 1 Pole

Nominal voltage U_N	Coil code	Operating range		Rated coil consumption I at U_N	Power consumption P at U_N
		U_{min}	U_{max}		
V		V	V	mA	W
6	7.006	5	7.2	35	0.2
12	7.012	9.8	14.4	15.2	0.2
24	7.024	18.2	28.8	10.4	0.3
48	7.048	35	57.6	6.3	0.3
60	7.060	43.5	72	7	0.4

Coil data, leakage current suppression types, 1 Pole

Nominal voltage U_N	Coil code	Operating range		Must drop out U	Rated coil consumption I at U_N	Power consumption P at U_N
		U_{min}	U_{max}			
V		V	V		mA	W
(110...125) AC/DC	3.125	94	138	44	8(*)	1(*)
(230...240) AC	3.240	184	264	92	7(*)	0.5(*)

(*) Rated coil consumption and power consumption values relate to $U_N = 125$ and 240 V.

The 38 Series interface modules (supply version 3) have built-in leakage current suppression to address industry concerns of the contacts not dropping-out when there is residual current in the circuit; at (110...125)V AC and (230...240)V AC.

This problem can occur, for example, when connecting the interface modules to PLC,s with triac outputs or when connecting via relatively long cables.

Electromechanical Relay 2 Pole

Coil specifications

Coil data sensitive DC, 2 Pole

Nominal voltage U_N	Coil code	Operating range		Rated coil consumption I at U_N
		U_{min}	U_{max}	
V		V	V	mA
12	7.012	9.6	14.4	41
24	7.024	19.2	28.8	19.5
60	7.060	48	72	8

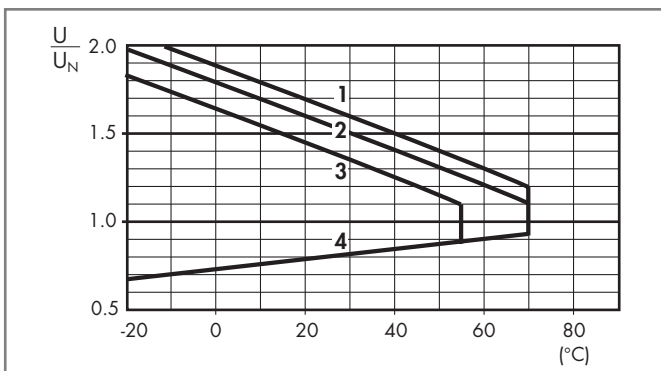
R 38 - DC coil operating range v ambient temperature
1 Pole and 2 Pole

- 1 - Max. permitted coil voltage at nominal load (DC coil).
- 2 - Max. permitted coil voltage at nominal load (AC/DC coils ≤ 60 V).
- 3 - Max. permitted coil voltage at nominal load (AC/DC coils > 60 V).
- 4 - Min pick-up voltage with coil at ambient temperature.

Solid State Relay

Technical data

Other data					
Power lost to the environment	without output current	W	0.17		
	with rated current	W	0.4		
			38.81	38.91	
Wire strip length	mm	10	10		
⊖ Screw torque	Nm	0.5	—		
Max. wire size		solid cable	stranded cable	solid cable	stranded cable
	mm ²	1x2.5 / 2x1.5	1x2.5 / 2x1.5	1x2.5	1x2.5
	AWG	1x14 / 2x16	1x14 / 2x16	1x14	1x14

Input specification

Input data - AC/DC

Nominal voltage U_N V	Supply code	Operating range		Release voltage U V	Control current I at U_N mA
		U_{min} V	U_{max} V		
110...125	0.125	88	138	45	5
230...240	0.240	184	264	90	4.5

Input data - DC

Nominal voltage U_N V	Supply code	Operating range		Release voltage U V	Control current I at U_N mA
		U_{min} V	U_{max} V		
6	7.006	5	7.2	2.4	7
24	7.024	16.8	30	10	10.5
60	7.060	35.6	72	20	6.5

Input data - Leakage current suppression types

Nominal voltage U_N V	Supply code	Operating range		Release voltage U V	Rated coil consumption I at U_N mA	Power consumption P at U_N W
		U_{min} V	U_{max} V			
110...125 AC/DC	3.125	94	138	44	8(*)	1(*)
230...240 AC	3.240	184	264	72	5.6(*)	0.5(*)

(*) Rated coil consumption and power consumption values relate to $U_N = 125$ and 240 V.

The 38 Series interface modules (supply version 3) have built-in leakage current suppression to address industry concerns of the contacts not dropping-out when there is residual current in the circuit; at (110...125)V AC and (230...240)V AC.

This problem can occur, for example, when connecting the interface modules to PLC,s with triac outputs or when connecting via relatively long cables.