



PS6R Series Switching Power Supplies

Expandable and space-saving switching power supplies. High efficiency reduces operation costs.

- 93% efficiency
- Plug-in output modules for additional output voltages
- Plug-in branch terminal module for additional terminals
- Power Range: 120W, 240W, 480W
- Input voltage: 100 to 240V AC (voltage range: 85 to 264V AC/110 to 350V DC)
- Up to 70°C (158°F) operating temperature
- DC low LED indicator and output contact
- The terminals are captive spring-up screws. Ring or fork terminals can be used.
- Finger-safe construction prevents electric shocks.
- Panel mount bracket and side-mount panel mounting bracket. Can be attached to a DIN rail or directly to a panel surface.
- RoHS compliant



Applicable Standards	Mark	File No. or Organization
UL508 CSA C22.2 No. 107.1		UL/c-UL Listed File No. E177168
EN60950-1 EN50178 EN61204-3	 	TÜV SÜD EU Low Voltage Directive EMCD

SEMI, ANSI (Hazardous location), and Maritime standards are pending.

Part Numbers

PS6R

Output Capacity*	Part No.	Input Voltage	Output Voltage	Output Current
120W	PS6R-F24	100 to 240V AC	21.6 to 26.4V	5A
240W	PS6R-G24			10A
480W	PS6R-J24			20A

*Output voltage × output current = output capacity



120W shown with Branch Terminal module attached.

Accessories

Item	Part No.	Note
Output Voltage Expansion Module ^{Note 1}	PS9Z-6RM1	Output: +5V, 2A, 10W
	PS9Z-6RM2	Output: +12V, 1A, 12W
	PS9Z-6RM3	Output: +5V, 1A/-5V, 1A, 10W
	PS9Z-6RM4	Output: +15V, 0.4A/-15V, 0.4A, 12W
	PS9Z-6RM5	Output: +5V, 1A/+12V, 0.5A, 11W
	PS9Z-6RM6	Output: +12V, 0.5A/-12V, 0.5A, 12W
Branch Terminal Module ^{Note 2}	PS9Z-6RS1	Additional screw terminals for wiring: 2 + terminals / 2 - terminals
Panel Mounting Bracket	PS9Z-6R1F	
Side-mount Panel Mounting Bracket	PS9Z-6R2F	Supplied with M3 × 6 countersunk mounting screws
DIN Rail	BNDN1000	1,000mm
DIN Rail End Clip	BNL6	

1. When using an output voltage expansion module, reduce 1A from the output current of PS6R.
2. When using a branch terminal module, the total voltage/current of PS6R and the branch terminal module should not exceed the rated current/voltage of PS6R

Specifications

PS6R

Part No.		PS6R-F24	PS6R-G24	PS6R-J24	
Input	Input Voltage	100 to 240V AC (Voltage range: 85 to 264V AC/110 to 350V DC) (Load ≤ 80% at 85 to 100V AC, 110 to 140V DC) ^{Note 1}			
	Frequency	50/60Hz			
	Input Current	100V AC	1.4A typ	2.7A typ	5.5A typ.
		230V AC	0.7A typ	1.2A typ	2.3A typ.
	Inrush Current	100V AC	9A max. (Ta=25°C, 100V AC cold start)		
		230V AC	20A max. (Ta=25°C, 230V AC cold start)		
	Leakage Current	120V AC	0.5mA max.		
		230V AC	1mA max.		
Efficiency (Typical)	100V AC	90%	90%	91%	
	230V AC	90%	91%	93%	
Power Factor (Typical)	100V AC	0.99	0.99	0.98	
	230V AC	0.96	0.97	0.97	
Output	Rated Voltage/Current	24V/5A	24V/10A	24V/20A	
	Adjustable Voltage Range	±10%			
	Output Holding Time	20ms min. (at rated input and output)			
	Start Time	800ms max. (at rated input and output)			
	Rise Time	200ms max. (at rated input and output)			
	Regulation	Total Fluctuation	±5% max.		
		Input Fluctuation	0.4% max.		
		Load Fluctuation	0.6% max.		
		Temperature Change	0.05%/oC max. (-10 to +60°C)		
		Ripple (including noise)	1% p-p max. (0 to +60°C) 1.5% p-p max. (-10 to 0°C)		
Supplementary Functions	Overcurrent Protection	105 to 120% (auto reset) (output current when voltage drops by 5%)			
	Overvoltage Protection	Output off at 120% ^{Note 2}			
	Operation Indicator	LED (green)			
	Voltage Low Indication	LED (amber)			
Dielectric Strength	Between input and output terminals	3000V AC, 1 minute			
	Between input and ground terminals	2000V AC, 1 minute			
	Between output and ground terminals	500V AC, 1 minute			
Insulation Resistance		100MΩ min. 500V DC megger (between input and output terminals/between input and ground terminals) (at room temperature and normal humidity)			
Operating Temperature		-10 to +70°C (no freezing) ^{Note 3}			
Operating Humidity		20 to 90% RH (no condensation)			
Storage Temperature		-25 to +75°C (no freezing)			
Storage Humidity		20 to 90% RH (no condensation)			
Vibration Resistance		10 to 55 Hz, amplitude 0.375 mm (0.187mm using PS9Z-6R1F) 2 hours each in 3 axes, 6 directions			
Shock Resistance		300 m/s ² (150 m/s ² when using a PS9Z-6R1F panel mounting bracket)			
EMC	EMI	EN61204-3 (Class B)			
	EMS	EN61204-3 (industrial)			
Degree of Protection		IP20 (IEC 60529)			
Weight (approx.)		630g	960g	1400g	
Terminal Screw		M3.5 (See last page for wire sizes)			

1. DC input voltage is not subjected to safety standards.

2. One minute after the output has been turned off, turn on the input again.

3. See the output derating curves.

■ Easily Expandable



Output Voltage Expansion Module

In addition to the standard 24V output, additional 5, 12, and 15V outputs can be added.

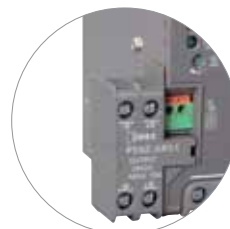

Branch Terminal Module

Two terminals can be added. No wiring is required, reducing installation space.

Accessories (For use with PS6R)

Part No.	Output Voltage Expansion Module						Branch Terminal Module		
	PS9Z-6RM1	PS9Z-6RM2	PS9Z-6RM3	PS9Z-6RM4	PS9Z-6RM5	PS9Z-6RM6	PS9Z-6RS1		
Input Voltage	24V DC								
Output Capacity	10W max.	12W max.	10W max.	12W max.	11W max.	12W max.	—		
Output	Rated Voltage/Current	5V/2A	12V/1A	±5V 2A	±15V 0.4A	5V/1A, 12V/0.5A	±12V 0.5A	24V/10A max. ^{Note 1}	
	Adjustable Voltage Range	Not available							
	Voltage Accuracy	±5% max.						—	
	Start Time	200 ms max. (at rated input and output)						—	
	Regulation	Input Fluctuation	0.5% max.						
		Load Fluctuation	1.0% max.						
Temperature Change		0.05%/max. (-10 to +60°C)						—	
Ripple (including noise)		100mV max.	150mV max.	100mV max., 150mV max.					
Supplementary Functions	Overcurrent Protection	105% (auto reset)							
	Overvoltage Protection	Output off at 120%						—	
Operating Temperature	-10 to +70°C (no freezing) ^{Note 2}								
Operating Humidity	20 to 90%RH (no condensation)								
Storage Temperature	-25 to +75°C (no freezing)								
Storage Humidity	20 to 90% RH (no condensation)								
Vibration Resistance	10 to 55 Hz, amplitude 0.375 mm, 2 hours each in 3 axes, 6 directions (in combination with PS6R-J24)								
Shock Resistance	300 m/s ² (150 m/s ² when using a PS9Z-6R1F panel mounting bracket), 3 shocks each in 6 axes (in combination with PS6R-J24)								
EMC	EMI	EN61204-3 (Class B) (in combination with PS6R-□24)							
	EMS	EN61204-3 (industrial) (in combination with PS6R-□24)						—	
Safety Standards	UL508 (Listing), CSA C22.2 No.107.1, IEC/EN60950-1, EN50178 (in combination with PS6R-□24)								
Degree of Protection	IP20 (IEC 60529)								
Weight (approx.)	90g						30g		
Terminal Screw	M3.5 (See last page for wire sizes.)								

1. Ensure that the current does not exceed the rated current of the PS6R.
2. See the output derating curves.

Wide Operating Temperature Range

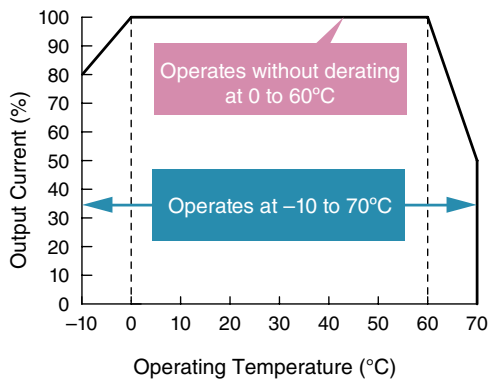

Energy-saving 93% Efficiency (480W)

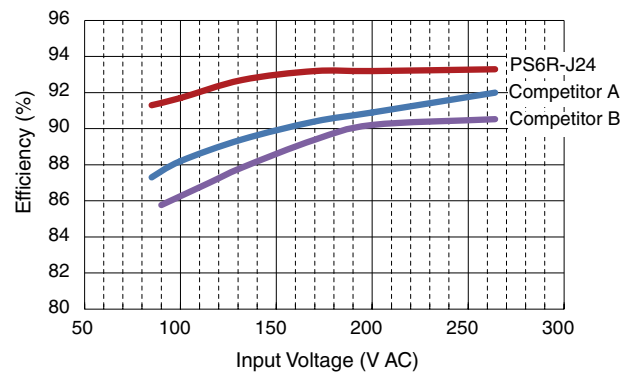

Easy Maintenance - LED Indicator

Status	Normal	Overload or Input Voltage Low*	Output short-circuit	Output OFF
DC ON (green LED)				
DC Low (amber LED)				

*The LEDs turn on when the input voltage drops.

Dimensions (mm)

PS6R-F24

6 - M3.5 Terminal Screws

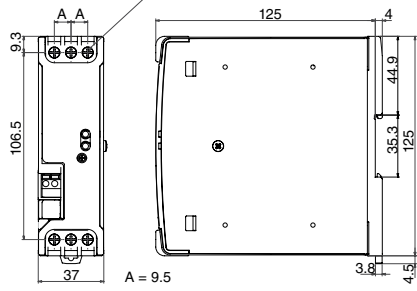

PS6R-G24

8 - M3.5 Terminal Screws

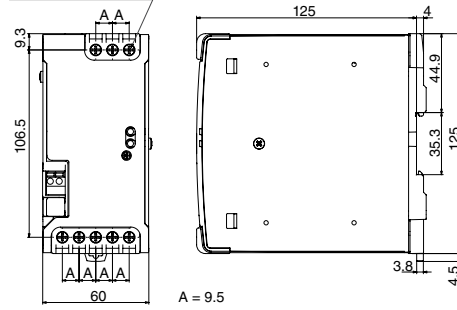

PS6R-J24

10-M3.5 Terminal Screws

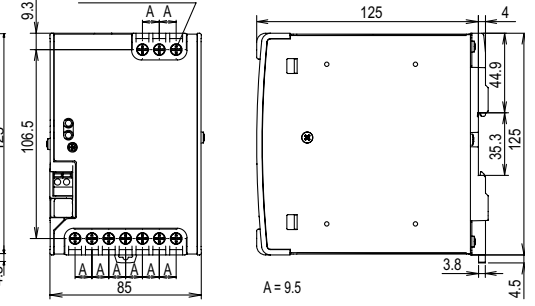

PS9Z-6R1F Panel Mounting Bracket

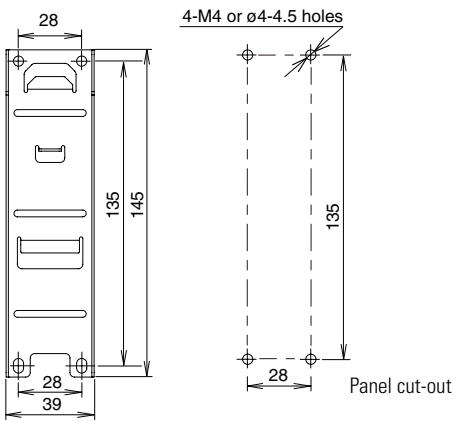

When a PS9Z-6R1F is installed on PS6R

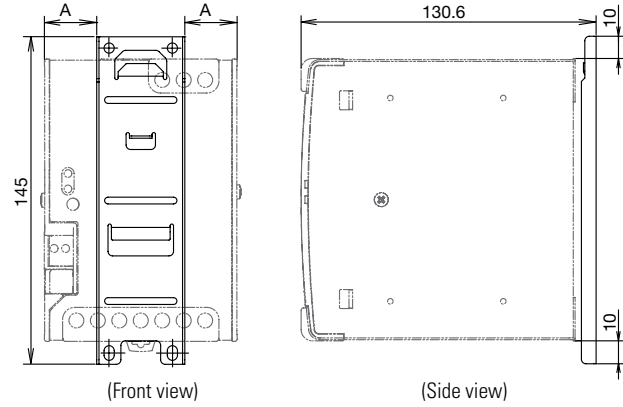

PS9Z-6R2F

Side-mount Panel Mounting Bracket

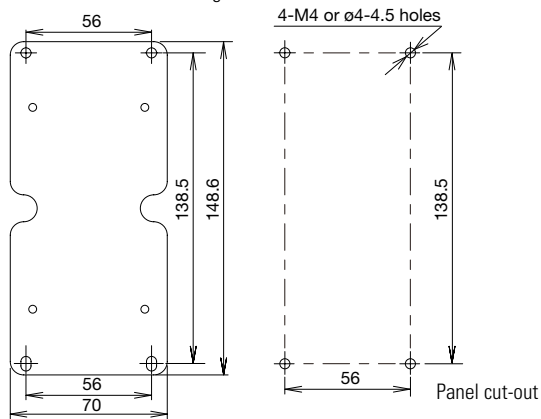

When a PS9Z-6R2F is installed on PS6R

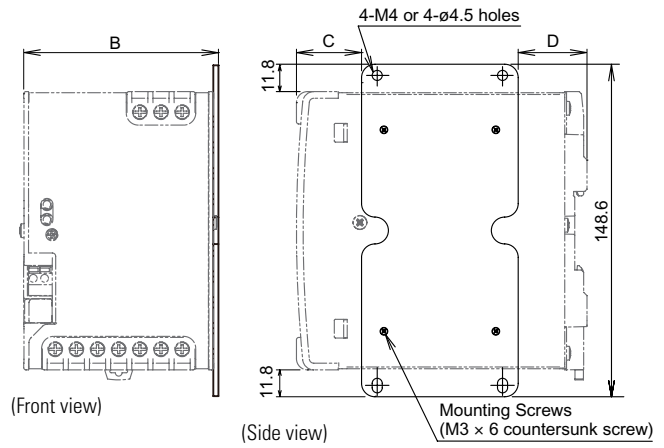

When using a PS9Z-6RM* Output Voltage Expansion Module

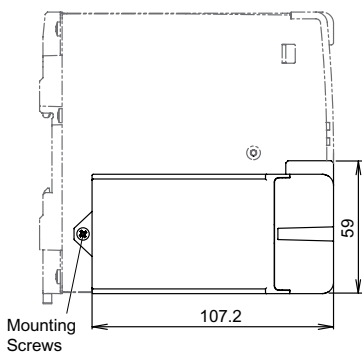

When using a PS9Z-6RS1 Branch Terminal Module

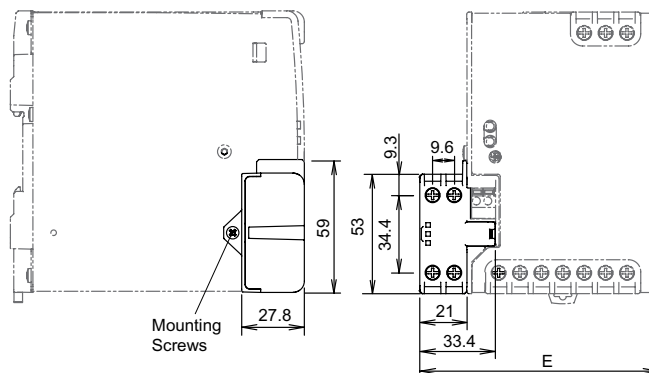

Dimension Table

	A	B	C	D	E
PS6R-F24	-	39.3	29.5	29.5	58
PS6R-G24	10.5	62.3	29.5	31	81
PS6R-J24	23	87.3	29.5	31	106

Parts Description

PS6R-J24

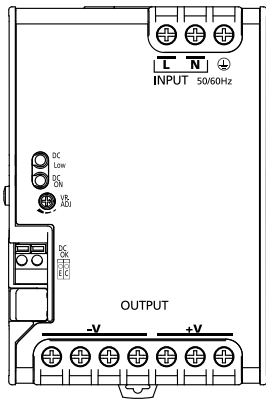

PS6R-6RM1/M2/M3

Output Voltage Expansion Module

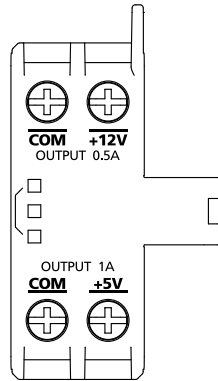

PS9Z-6RM3/M4/M6

Output Voltage Expansion Module

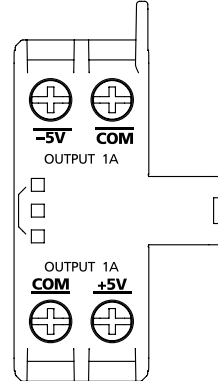

PS6R-6RS1

Branch Terminal Module

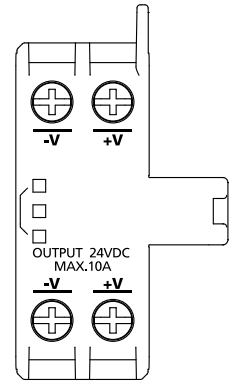

(PS6R-6RM5 shown)

PS6R-□24/PS9Z-6RS1

Marking	Name	Description
L, N	Input Terminal	Voltage range: 85 to 264V AC/110 to 350V DC
⊕	Ground Terminal	Be sure to connect this terminal to a proper ground.
+V, -V	DC Output Terminals	+V: Positive output terminal -V: Negative output terminal
VR.ADJ	Output Voltage Adjustment	Allows adjustment within ±10%. Turning clockwise increases the output voltage.
DC ON	Operation Indicator (green)	Lights on when the output voltage is on.
DC LOW	Output Low Indicator (Amber)	Lights on when the output voltage drops approximately 80% of the rated value.
DC OK	DC OK Output	Lights on when the output voltage is more than 80% of the rated value. NPN transistor output (50V DC max., 50 mA max.)

PS9Z-6RM□

Marking	Name	Description
+5V, +12V, +15V	DC Output Terminal	+5V side, +12V side, +15V side
-5V, -12V, -15V	DC Output Terminal	-5V side, -12V side, -15V side
COM	DC Output Terminal	0V side (wired internally to -V of PR6R-J24)

Characteristics

Operating Temperature vs.
Output Current (Derating Curves)

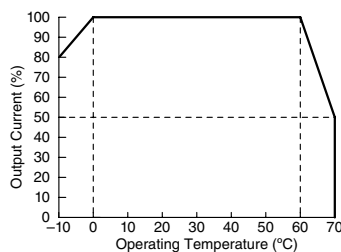

Output Current vs. Input Voltage
(Derating Curves) (Ta=25°C)

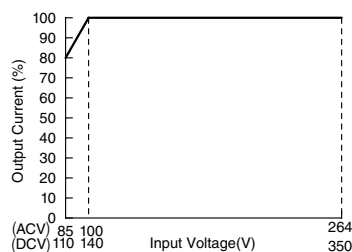

Overcurrent Protection Characteristics
PS6R-□24

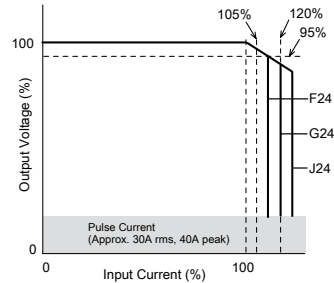

Overcurrent Protection Characteristics PS9Z-6RM*

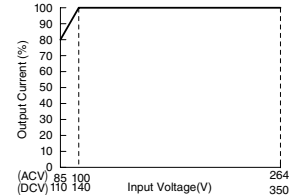

Operating Temperature approved by Safety Standards

Part No.	UL508, CSA C22.2 No. 107. 1	EN60950-1, EN50178
PS6R-F24	60°C	60°C
PS6R-G24	60°C	60°C
PS6R-J24	55°C	60°C
PS9Z-6RM□□	55°C	60°C

Operating Instructions

The PS6R should be placed in a proper enclosure. It is designed to be used with general electrical equipment and industrial electric devices.

Operation Notes

1. Output interruption may indicate blown fuses. Contact IDEC.
2. The PS6R contains an internal fuse for AC input. When using DC input, install an external fuse or DC input. To avoid blown fuses, select a fuse in consideration of the rated current of the internal fuse.

Rated Current of Internal Fuses

Part No.	Internal Fuse Rated Current
PS6R-F24	4A
PS6R-G24	6.3A
PS6R-J24	10A

- Avoid overload and short-circuit for a long period of time, otherwise internal elements may be damaged.
- DC input operation is not subjected to safety standards.

Installation Notes

- The PS6R can be installed in the direction shown below only.

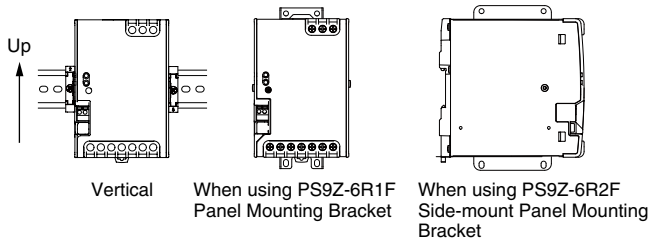

- Do not close the top and bottom openings of the PS6R to allow for heat radiation by convection.
- Maintain a minimum of 20mm clearance around the PS6R, except for the top and bottom openings.
- When derating of the output does not work, provide forced air-cooling.
- Make sure to wire the ground terminal correctly.
- For wiring, use wires with heat resistance of 60°C or higher. Use copper wire of the following sizes. Wires of the following sizes must be used to comply with UL508, CSA C22.2 No. 107.1.

Model	Terminal	Wire Size/No. of Wire	Wire Type	Torque, in-ibs (N.m)
PS6R-F24 PS6R-G24	Input	18-14 AWG, 1-wire	Copper Solid/Stranded	7.0 (0.8)
	Output	18-14 AWG, 1-wire, (18 AWG - 7A, 16 AWG - 10A, 14 AWG - 15A)		
	DC OK Output	22-14 AWG, 1-wire (stripped wire length: 6 to 7mm)		
PS6R-J24	Input	18-14 AWG, 1-wire	Copper Solid/Stranded	7.0 (0.8)
	Output	18-14 AWG, 2-wire Use the same size wire for each terminal (18 AWG - 7A, 16 AWG - 10A, 14 AWG - 15A)		
			12 AWG, 1-wire Use with UL-listed ring/fork crimp terminal.	
	DC OK Output	22-14 AWG, 1-wire (stripped wire length: 6 to 7mm)	Copper Solid/Stranded	—
PS9Z-6R□	Output	18-14 AWG, 1-wire (18 AWG - 7A, 16 AWG - 10A, 14 AWG - 15A)	Copper Solid/Stranded	7.0 (0.8)

Applicable Crimp Terminal (reference)

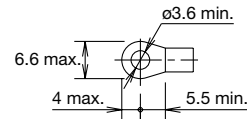

- Recommended tightening torque of the input and output terminals is 0.8N-m.
- The output voltage can be adjusted within ±10% of the rated output voltage by using the V.ADJ control. Note that overvoltage protection may work when increasing the output voltage.
- When large shocks or heavy vibrations on the PS6R are expected, the use of DIN rail or PS9Z-6R2F side-mount panel mounting bracket is recommended.

Series Operation

The following series operation is allowed. Connect Schottky barrier diodes as shown below. Output voltage expansion modules cannot be connected in series.

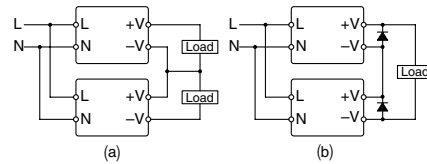

Select a Schottky diode in consideration of the rated current. The diode's reverse voltage must be higher than the PS6R's output voltage.

Parallel Operation

Parallel operation is possible to increase the output capacity. Output voltage expansion modules cannot be connected in series.

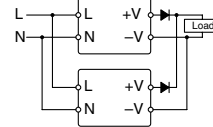

When increasing the capacity, observe the following.

1. Maintain the operating temperature below 40°C.
2. Output cannot be connected directly in parallel operation. Connect a diode to the output of each PS6R.
3. Output terminal voltage of both power supplies must be the same. Also, maintain the voltage difference between the power supplies below 30mV.
4. Use load lines of the same diameter and length.
5. Set the output voltage higher for the amount of diode forward voltage drop.
6. Turn on the inputs at the same time.
7. Select a diode in consideration of:
 - Diode's reverse voltage must be higher than the PS6R's output voltage.
 - Diode's current must be three times the PS6R's output current. Provide a heat sink for heat dissipation.

