

PART NUMBER	HOLE DIAMETER	PANEL RANGE	"A"±.010	"B"±.010	"C"±.010	"D"±.010	"E" REF	"F" REF
TRM-1	.097-.103 [2.5-2.6]	.160-.180 [4.1-4.6]	.040 [1]	.190 [4.8]	.060 [1.5]	.345 [8.8]	N/A	N/A
TRM-2	.106-.112 [2.7-2.8]	.080-.105 [2-2.7]	.050 [1.3]	.218 [5.5]		.300 [7.6]		
TRM-3	.122-.128 [3.1-3.3]	.105-.130 [2.7-3.3]				.320 [8.1]		
TRM-4		.130-.155 [3.3-3.9]				.345 [7.6]		
TRM-5		.155-.180 [3.9-4.6]				.370 [9.4]		
TRM-6		.240-.265 [6.1-6.7]				.455 [11.6]		
TRM-7		.265-.290 [6.7-7.4]	.300 [7.6]	.470 [11.9]		.045 [1.1]		

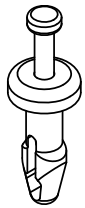

TRM-1

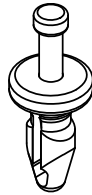

TRM-2



TRM-3

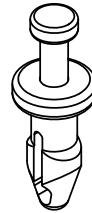

TRM-4

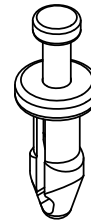

TRM-5

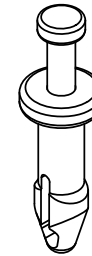

TRM-6

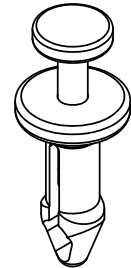

TRM-7

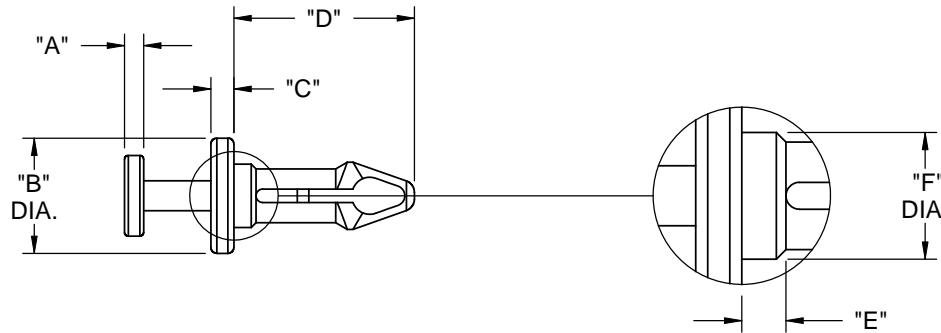

NOTES:

1. MATERIAL: HEAT STABILIZED NYLON 6/6  
UL 94 V-2, (RMS-47).
2. COLOR: BLACK
3. ALTERNATE UNITS FOR REFERENCE ONLY.

B	SEE CO 200311	SK	01/21/09
A	RELEASED FOR PRODUCTION	SK	10/27/08
REV.	DESCRIPTION	ENGR.	DATE

TITLE: <b>TOUGH RIVET MINI</b>						DWG IN IN [MM]	
CREATED USING SOLIDWORKS	FILE #: TRM	DWN: R.D.G.	APP: R.D.G.	FINAL			
TOLERANCES UNLESS NOTED .XX=±.010 .XXX=±.005 FRAC.=±1/64 ANG.=±1°	SHEET: 1 OF 1	SHEET SIZE: A	DT: 03/06/06	CHKD: D.Z.	PART #		PRINT TYPE
RE: RICHCO, INC. --		RICHCO, INC. ENG@RICHCO-INC.COM (773) 539-4060		SEE TABLE		CA	