

### FAZ-NA Circuit Breakers



*Optimum and Efficient Protection for Every Application*

### Contents

#### Description

	<i>Page</i>
FAZ-NA Circuit Breakers	
Catalog Number Selection . . . . .	<b>V4-T1-50</b>
Product Selection . . . . .	<b>V4-T1-51</b>
Accessories . . . . .	<b>V4-T1-55</b>
Technical Data and Specifications . . . . .	<b>V4-T1-57</b>
Dimensions . . . . .	<b>V4-T1-66</b>
WMZ Circuit Breaker . . . . .	<b>V4-T1-67</b>

## FAZ-NA Circuit Breakers

### Product Overview

Optimum product quality, tested reliability and safety stand for best protection of personnel, installations and plant. Eaton's FAZ-NA DIN rail mountable circuit breaker is designed for use in branch service applications.

### Powerful Offering for Machine and System Builders

The FAZ-NA is available with B, C and D characteristics in accordance with UL<sup>®</sup> 489, CSA<sup>®</sup> C22.2 No.5; UL 1077, CSA C22.2 No.235 and IEC 60947-2. These devices are CE marked.

### Application Description

Feeder and branch circuit protection for:

- Convenience receptacle circuits (internal/external)
- Motor control circuits
- Load circuits leaving the equipment (external)
- HACR internal/external equipment (heating, air conditioning, refrigeration)
- PLC I/O points
- Computers
- Power supplies
- Control instrumentation
- Relays
- UPS
- Power conditioners

### Features

- Complete range of UL 489 listed DIN rail mounted miniature circuit breakers up to 40A current rating
- Standard ratings of 10 kAIC up to 277/480 Vac
- Select amperages available at 14 kAIC up to 277/480 Vac and 10 kAIC up to 125 Vdc per pole
- Current limiting design provides fast short-circuit interruption that reduces the let-through energy, which can damage the circuit
- Suitable for branch circuit device protection
- Thermal-magnetic overcurrent protection
  - Three levels of short-circuit protection, categorized by B, C and D curves
- Trip-free design—breaker can not be defeated by holding the handle in the ON position
- Captive screws cannot be lost
- SWD (switching duty)—suitable for switching fluorescent lighting loads ( $I_n \leq 20A$ )
- Fulfill UL 489, CSA C22.2 No.5 and also IEC 60947-2 Standard
- For use in applications for which UL 1077 or CSA C22.2 No.235 are also allowed
- Field-installable shunt trip and auxiliary switch subsequent mounting
- Separate version for ring-tongue connection (Type FAZ-RT), terminal screws can be removed (on both sides)
- Module width of only 17.7 mm (per pole)
- Contact Position Indicator (red/green)
- Easy installation on DIN rail
- Possibility for sealing the toggle in ON or OFF position

### Device Printing on Front and Side Installation options

These branch circuit breakers are available in two terminal configurations: standard box terminals that accept multiple conductors and ring-tongue terminals, ideally suited to demanding requirements of the semi-conductor industry. All breakers mount on standard 35 mm DIN rail. Bus connectors and feeder terminal facilitate mounting and wiring of multiple miniature circuit breaker arrays in control panel assemblies. These circuit breakers can also be reverse feed.

# 1.2

## Miniature Circuit Breakers and Supplementary Protectors

### UL 489 DIN Rail Miniature Circuit Breakers

1

#### Standards and Certifications

FAZ-NA complies with the latest national and international standards.

- RoHS compliant
- VDE compliant
- ABS compliant

• UL 489

- Standard for molded case circuit breakers (MCCB) for feeder and branch circuit protection
- Products meet the requirements of the National Electrical Code® (NEC®)



• CSA C22.2 No.5

- Standard for molded case circuit breakers (MCCB) for feeder and branch circuit protection (corresponds closely to UL 489 Standard)
- Products meet the requirements of the Canadian Electrical Code (CEC)

#### Catalog Number Selection

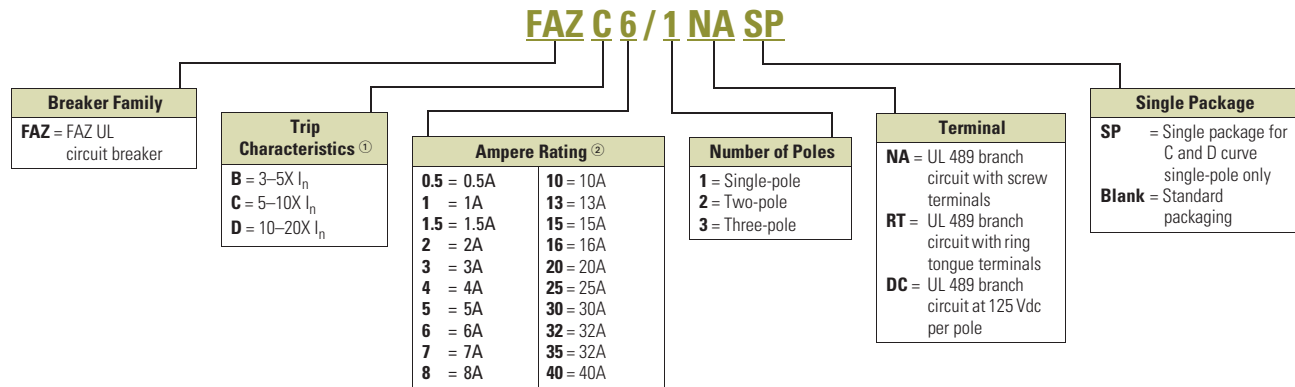

**Notes**

- ① I<sub>n</sub> = Rated current for instantaneous trip characteristics.
- ② B curve starts at 1 ampere.

### Product Selection

#### FAZ-NA B Curve

- UL approved (UL 489) and CSA Certified (CSA C22.2 No.5-02) as branch circuit breakers
- Interrupting capacity: 10 kA UL/CSA; 15 kA IEC 60947-2
- Current limiting device
- UL file number E235139

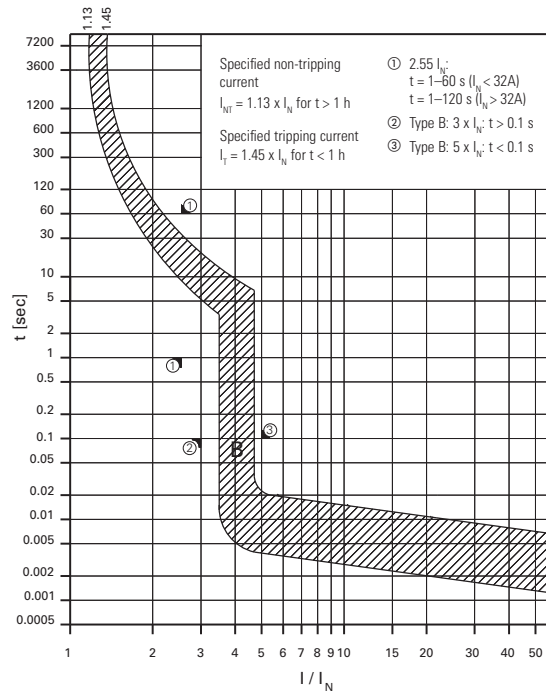

#### Single-Pole



#### Two-Pole



#### Three-Pole



### FAZ-NA UL 489 Circuit Breakers— 10 kAIC, 14 kAIC B Curve (15–25A)

Amperes	Single-Pole <sup>①</sup> Catalog Number	Two-Pole Catalog Number	Three-Pole Catalog Number
<b>B Curve (3–5X I<sub>n</sub> Current Rating)</b>			
1	FAZ-B1/1-NA	FAZ-B1/2-NA	FAZ-B1/3-NA
1.5	FAZ-B1.5/1-NA	FAZ-B1.5/2-NA	FAZ-B1.5/3-NA
2	FAZ-B2/1-NA	FAZ-B2/2-NA	FAZ-B2/3-NA
3	FAZ-B3/1-NA	FAZ-B3/2-NA	FAZ-B3/3-NA
4	FAZ-B4/1-NA	FAZ-B4/2-NA	FAZ-B4/3-NA
5	FAZ-B5/1-NA	FAZ-B5/2-NA	FAZ-B5/3-NA
6	FAZ-B6/1-NA	FAZ-B6/2-NA	FAZ-B6/3-NA
7	FAZ-B7/1-NA	FAZ-B7/2-NA	FAZ-B7/3-NA
8	FAZ-B8/1-NA	FAZ-B8/2-NA	FAZ-B8/3-NA
10	FAZ-B10/1-NA	FAZ-B10/2-NA	FAZ-B10/3-NA
13	FAZ-B13/1-NA	FAZ-B13/2-NA	FAZ-B13/3-NA
15	FAZ-B15/1-NA	FAZ-B15/2-NA	FAZ-B15/3-NA
16	FAZ-B16/1-NA	FAZ-B16/2-NA	FAZ-B16/3-NA
20	FAZ-B20/1-NA	FAZ-B20/2-NA	FAZ-B20/3-NA
25	FAZ-B25/1-NA	FAZ-B25/2-NA	FAZ-B25/3-NA
30	FAZ-B30/1-NA	FAZ-B30/2-NA	FAZ-B30/3-NA
32	FAZ-B32/1-NA	FAZ-B32/2-NA	FAZ-B32/3-NA
35 <sup>②</sup>	FAZ-B35/1-NA	FAZ-B35/2-NA	FAZ-B35/3-NA
40 <sup>②</sup>	FAZ-B40/1-NA	FAZ-B40/2-NA	FAZ-B40/3-NA

#### Single-Pole



#### Two-Pole



#### Three-Pole



### FAZ-RT UL 489 Circuit Breakers with Ring-Tongue Terminals— 10 kAIC, 14 kAIC B Curve (15–25A)

Amperes	Single-Pole <sup>①</sup> Catalog Number	Two-Pole Catalog Number	Three-Pole Catalog Number
<b>B Curve with Ring-Tongue Terminals (3–5X I<sub>n</sub> Current Rating)</b>			
1	FAZ-B1/1-RT	FAZ-B1/2-RT	FAZ-B1/3-RT
1.5	FAZ-B1.5/1-RT	FAZ-B1.5/2-RT	FAZ-B1.5/3-RT
2	FAZ-B2/1-RT	FAZ-B2/2-RT	FAZ-B2/3-RT
3	FAZ-B3/1-RT	FAZ-B3/2-RT	FAZ-B3/3-RT
4	FAZ-B4/1-RT	FAZ-B4/2-RT	FAZ-B4/3-RT
5	FAZ-B5/1-RT	FAZ-B5/2-RT	FAZ-B5/3-RT
6	FAZ-B6/1-RT	FAZ-B6/2-RT	FAZ-B6/3-RT
7	FAZ-B7/1-RT	FAZ-B7/2-RT	FAZ-B7/3-RT
8	FAZ-B8/1-RT	FAZ-B8/2-RT	FAZ-B8/3-RT
10	FAZ-B10/1-RT	FAZ-B10/2-RT	FAZ-B10/3-RT
13	FAZ-B13/1-RT	FAZ-B13/2-RT	FAZ-B13/3-RT
15	FAZ-B15/1-RT	FAZ-B15/2-RT	FAZ-B15/3-RT
16	FAZ-B16/1-RT	FAZ-B16/2-RT	FAZ-B16/3-RT
20	FAZ-B20/1-RT	FAZ-B20/2-RT	FAZ-B20/3-RT
25	FAZ-B25/1-RT	FAZ-B25/2-RT	FAZ-B25/3-RT
30	FAZ-B30/1-RT	FAZ-B30/2-RT	FAZ-B30/3-RT
32	FAZ-B32/1-RT	FAZ-B32/2-RT	FAZ-B32/3-RT
35 <sup>②</sup>	FAZ-B35/1-RT	FAZ-B35/2-RT	FAZ-B35/3-RT
40 <sup>②</sup>	FAZ-B40/1-RT	FAZ-B40/2-RT	FAZ-B40/3-RT

#### Notes

- <sup>①</sup> Two-piece order. Quantities of two per box.
- <sup>②</sup> 240 Vac rated only.

# 1.2

## Miniature Circuit Breakers and Supplementary Protectors

### UL 489 DIN Rail Miniature Circuit Breakers

1

#### FAZ-NA C Curve

- UL approved (UL 489) and CSA Certified (CSA C22.2 No.5-02) as branch circuit breakers
- Interrupting capacity: 10 kA UL/CSA; 15 kA IEC 60947-2
- Current limiting device
- UL file number E235139

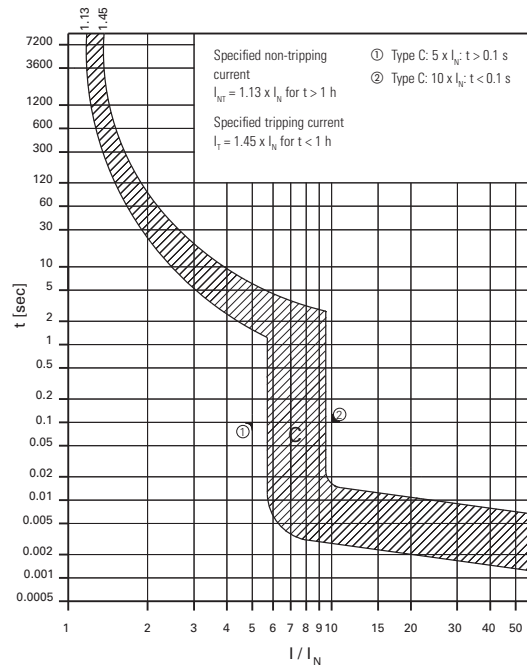

#### Single-Pole



#### Two-Pole



#### Three-Pole



#### FAZ-NA UL 489 Circuit Breakers— 10 kAIC, 14 kAIC C Curve (15–25A)

Amperes	Single-Pole ① Catalog Number	Two-Pole Catalog Number	Three-Pole Catalog Number
<b>C Curve (5–10X I<sub>N</sub> Current Rating)</b>			
0.5	FAZ-C0.5/1-NA-SP	FAZ-C0.5/2-NA	FAZ-C0.5/3-NA
1	FAZ-C1/1-NA-SP	FAZ-C1/2-NA	FAZ-C1/3-NA
1.5	FAZ-C1.5/1-NA-SP	FAZ-C1.5/2-NA	FAZ-C1.5/3-NA
2	FAZ-C2/1-NA-SP	FAZ-C2/2-NA	FAZ-C2/3-NA
3	FAZ-C3/1-NA-SP	FAZ-C3/2-NA	FAZ-C3/3-NA
4	FAZ-C4/1-NA-SP	FAZ-C4/2-NA	FAZ-C4/3-NA
5	FAZ-C5/1-NA-SP	FAZ-C5/2-NA	FAZ-C5/3-NA
6	FAZ-C6/1-NA-SP	FAZ-C6/2-NA	FAZ-C6/3-NA
7	FAZ-C7/1-NA-SP	FAZ-C7/2-NA	FAZ-C7/3-NA
8	FAZ-C8/1-NA-SP	FAZ-C8/2-NA	FAZ-C8/3-NA
10	FAZ-C10/1-NA-SP	FAZ-C10/2-NA	FAZ-C10/3-NA
13	FAZ-C13/1-NA-SP	FAZ-C13/2-NA	FAZ-C13/3-NA
15	FAZ-C15/1-NA-SP	FAZ-C15/2-NA	FAZ-C15/3-NA
16	FAZ-C16/1-NA-SP	FAZ-C16/2-NA	FAZ-C16/3-NA
20	FAZ-C20/1-NA-SP	FAZ-C20/2-NA	FAZ-C20/3-NA
25	FAZ-C25/1-NA-SP	FAZ-C25/2-NA	FAZ-C25/3-NA
30	FAZ-C30/1-NA-SP	FAZ-C30/2-NA	FAZ-C30/3-NA
32	FAZ-C32/1-NA-SP	FAZ-C32/2-NA	FAZ-C32/3-NA
35 ②	FAZ-C35/1-NA-SP	FAZ-C35/2-NA	FAZ-C35/3-NA
40 ②	FAZ-C40/1-NA-SP	FAZ-C40/2-NA	FAZ-C40/3-NA

#### Single-Pole



#### Two-Pole



#### Three-Pole



#### FAZ-RT UL 489 Circuit Breakers with Ring-Tongue Terminals— 10 kAIC, 14 kAIC C Curve (15–25A)

Amperes	Single-Pole ① Catalog Number	Two-Pole Catalog Number	Three-Pole Catalog Number
<b>C Curve with Ring-Tongue Terminals (5–10X I<sub>N</sub> Current Rating)</b>			
0.5	FAZ-C0.5/1-RT-SP	FAZ-C0.5/2-RT	FAZ-C0.5/3-RT
1	FAZ-C1/1-RT-SP	FAZ-C1/2-RT	FAZ-C1/3-RT
1.5	FAZ-C1.5/1-RT-SP	FAZ-C1.5/2-RT	FAZ-C1.5/3-RT
2	FAZ-C2/1-RT-SP	FAZ-C2/2-RT	FAZ-C2/3-RT
3	FAZ-C3/1-RT-SP	FAZ-C3/2-RT	FAZ-C3/3-RT
4	FAZ-C4/1-RT-SP	FAZ-C4/2-RT	FAZ-C4/3-RT
5	FAZ-C5/1-RT-SP	FAZ-C5/2-RT	FAZ-C5/3-RT
6	FAZ-C6/1-RT-SP	FAZ-C6/2-RT	FAZ-C6/3-RT
7	FAZ-C7/1-RT-SP	FAZ-C7/2-RT	FAZ-C7/3-RT
8	FAZ-C8/1-RT-SP	FAZ-C8/2-RT	FAZ-C8/3-RT
10	FAZ-C10/1-RT-SP	FAZ-C10/2-RT	FAZ-C10/3-RT
13	FAZ-C13/1-RT-SP	FAZ-C13/2-RT	FAZ-C13/3-RT
15	FAZ-C15/1-RT-SP	FAZ-C15/2-RT	FAZ-C15/3-RT
16	FAZ-C16/1-RT-SP	FAZ-C16/2-RT	FAZ-C16/3-RT
20	FAZ-C20/1-RT-SP	FAZ-C20/2-RT	FAZ-C20/3-RT
25	FAZ-C25/1-RT-SP	FAZ-C25/2-RT	FAZ-C25/3-RT
30	FAZ-C30/1-RT-SP	FAZ-C30/2-RT	FAZ-C30/3-RT
32	FAZ-C32/1-RT-SP	FAZ-C32/2-RT	FAZ-C32/3-RT
35 ②	FAZ-C35/1-RT-SP	FAZ-C35/2-RT	FAZ-C35/3-RT
40 ②	FAZ-C40/1-RT-SP	FAZ-C40/2-RT	FAZ-C40/3-RT

#### Notes

- ① Option for single packaging on single-pole C and D curves only; add suffix SP when ordering.
- ② 240 Vac rated only.

### FAZ-NA D Curve

- UL approved (UL 489) and CSA Certified (CSA C22.2 No.5-02) as branch circuit breakers
- Interrupting capacity: 10 kA UL/CSA; 15 kA IEC 60947-2
- Current limiting device
- UL file number E235139

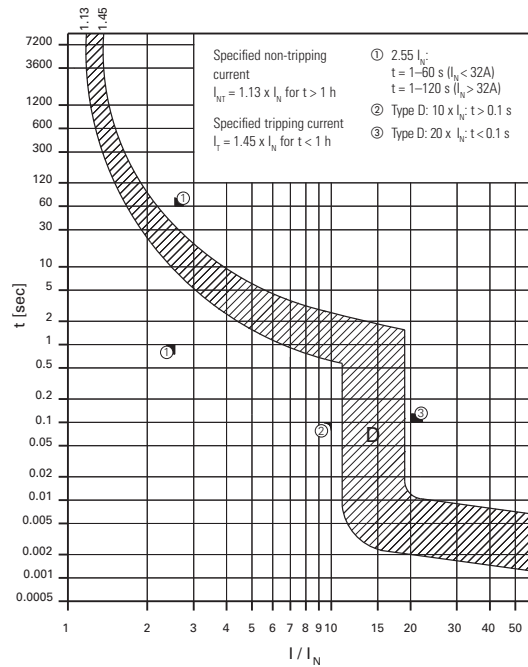

### Single-Pole



### Two-Pole



### Three-Pole



### FAZ-NA UL 489 Circuit Breakers— 10 kAIC, 14 kAIC D Curve (13–20A)

Amperes	Single-Pole ① Catalog Number	Two-Pole Catalog Number	Three-Pole Catalog Number
<b>D Curve (10–20X I<sub>N</sub> Current Rating)</b>			
0.5	FAZ-D0.5/1-NA-SP	FAZ-D0.5/2-NA	FAZ-D0.5/3-NA
1	FAZ-D1/1-NA-SP	FAZ-D1/2-NA	FAZ-D1/3-NA
1.5	FAZ-D1.5/1-NA-SP	FAZ-D1.5/2-NA	FAZ-D1.5/3-NA
2	FAZ-D2/1-NA-SP	FAZ-D2/2-NA	FAZ-D2/3-NA
3	FAZ-D3/1-NA-SP	FAZ-D3/2-NA	FAZ-D3/3-NA
4	FAZ-D4/1-NA-SP	FAZ-D4/2-NA	FAZ-D4/3-NA
5	FAZ-D5/1-NA-SP	FAZ-D5/2-NA	FAZ-D5/3-NA
6	FAZ-D6/1-NA-SP	FAZ-D6/2-NA	FAZ-D6/3-NA
7	FAZ-D7/1-NA-SP	FAZ-D7/2-NA	FAZ-D7/3-NA
8	FAZ-D8/1-NA-SP	FAZ-D8/2-NA	FAZ-D8/3-NA
10	FAZ-D10/1-NA-SP	FAZ-D10/2-NA	FAZ-D10/3-NA
13	FAZ-D13/1-NA-SP	FAZ-D13/2-NA	FAZ-D13/3-NA
15	FAZ-D15/1-NA-SP	FAZ-D15/2-NA	FAZ-D15/3-NA
16	FAZ-D16/1-NA-SP	FAZ-D16/2-NA	FAZ-D16/3-NA
20	FAZ-D20/1-NA-SP	FAZ-D20/2-NA	FAZ-D20/3-NA
25	FAZ-D25/1-NA-SP	FAZ-D25/2-NA	FAZ-D25/3-NA
30	FAZ-D30/1-NA-SP	FAZ-D30/2-NA	FAZ-D30/3-NA
32	FAZ-D32/1-NA-SP	FAZ-D32/2-NA	FAZ-D32/3-NA
35 ②	FAZ-D35/1-NA-SP	FAZ-D35/2-NA	FAZ-D35/3-NA
40 ②	FAZ-D40/1-NA-SP	FAZ-D40/2-NA	FAZ-D40/3-NA

### Single-Pole



### Two-Pole



### Three-Pole



### FAZ-RT UL 489 Circuit Breakers with Ring-Tongue Terminals— 10 kAIC, 14 kAIC D Curve (13–20A)

Amperes	Single-Pole ① Catalog Number	Two-Pole Catalog Number	Three-Pole Catalog Number
<b>D Curve with Ring-Tongue Terminals (10–20X I<sub>N</sub> Current Rating)</b>			
0.5	FAZ-D0.5/1-RT-SP	FAZ-D0.5/2-RT	FAZ-D0.5/3-RT
1	FAZ-D1/1-RT-SP	FAZ-D1/2-RT	FAZ-D1/3-RT
1.5	FAZ-D1.5/1-RT-SP	FAZ-D1.5/2-RT	FAZ-D1.5/3-RT
2	FAZ-D2/1-RT-SP	FAZ-D2/2-RT	FAZ-D2/3-RT
3	FAZ-D3/1-RT-SP	FAZ-D3/2-RT	FAZ-D3/3-RT
4	FAZ-D4/1-RT-SP	FAZ-D4/2-RT	FAZ-D4/3-RT
5	FAZ-D5/1-RT-SP	FAZ-D5/2-RT	FAZ-D5/3-RT
6	FAZ-D6/1-RT-SP	FAZ-D6/2-RT	FAZ-D6/3-RT
7	FAZ-D7/1-RT-SP	FAZ-D7/2-RT	FAZ-D7/3-RT
8	FAZ-D8/1-RT-SP	FAZ-D8/2-RT	FAZ-D8/3-RT
10	FAZ-D10/1-RT-SP	FAZ-D10/2-RT	FAZ-D10/3-RT
13	FAZ-D13/1-RT-SP	FAZ-D13/2-RT	FAZ-D13/3-RT
15	FAZ-D15/1-RT-SP	FAZ-D15/2-RT	FAZ-D15/3-RT
16	FAZ-D16/1-RT-SP	FAZ-D16/2-RT	FAZ-D16/3-RT
20	FAZ-D20/1-RT-SP	FAZ-D20/2-RT	FAZ-D20/3-RT
25	FAZ-D25/1-RT-SP	FAZ-D25/2-RT	FAZ-D25/3-RT
30	FAZ-D30/1-RT-SP	FAZ-D30/2-RT	FAZ-D30/3-RT
32	FAZ-D32/1-RT-SP	FAZ-D32/2-RT	FAZ-D32/3-RT
35 ②	FAZ-D35/1-RT-SP	FAZ-D35/2-RT	FAZ-D35/3-RT
40 ②	FAZ-D40/1-RT-SP	FAZ-D40/2-RT	FAZ-D40/3-RT

### Notes

- ① Option for single packaging on single-pole C and D curves only; add suffix SP when ordering.
- ② 240 Vac rated only.

# 1.2

## Miniature Circuit Breakers and Supplementary Protectors

### UL 489 DIN Rail Miniature Circuit Breakers

1

#### FAZ-NA-DC C Curve

- UL approved (UL 489) and CSA Certified (CSA C22.2 No.5-02) as Branch Circuit Breakers
- Interrupting capacity: 10 kA at 125 Vdc UL/CSA, 10 kA at 250 Vdc
- 125 Vdc for one-pole, 250 Vdc for two-pole in series
- Current limiting device
- Polarity (+/-) sensitive and not for use on photovoltaic string application
- UL file number E235139

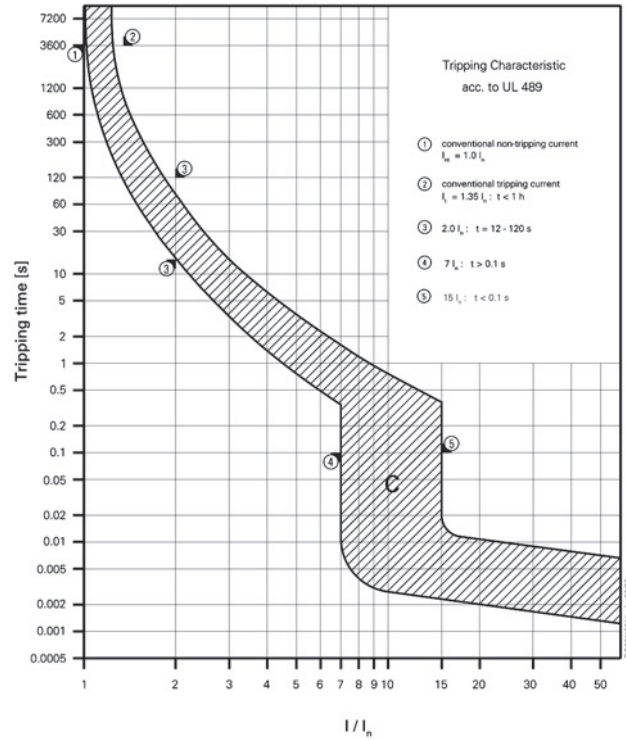

#### Single-Pole



#### Two-Pole



#### FAZ-NA-DC UL 489 Circuit Breakers— 10 kAIC at 125 Vdc Per Pole





Amperes	Single-Pole ① Catalog Number	Two-Pole Catalog Number
<b>C Curve (5–10X <math>I_n</math> Current Rating)</b>		
2	FAZ-C2/1-NA-DC-SP	FAZ-C2/2-NA-DC
3	FAZ-C3/1-NA-DC-SP	FAZ-C3/2-NA-DC
4	FAZ-C4/1-NA-DC-SP	FAZ-C4/2-NA-DC
5	FAZ-C5/1-NA-DC-SP	FAZ-C5/2-NA-DC
6	FAZ-C6/1-NA-DC-SP	FAZ-C6/2-NA-DC
7	FAZ-C7/1-NA-DC-SP	FAZ-C7/2-NA-DC
8	FAZ-C8/1-NA-DC-SP	FAZ-C8/2-NA-DC
10	FAZ-C10/1-NA-DC-SP	FAZ-C10/2-NA-DC
13	FAZ-C13/1-NA-DC-SP	FAZ-C13/2-NA-DC
15	FAZ-C15/1-NA-DC-SP	FAZ-C15/2-NA-DC
16	FAZ-C16/1-NA-DC-SP	FAZ-C16/2-NA-DC
20	FAZ-C20/1-NA-DC-SP	FAZ-C20/2-NA-DC
25	FAZ-C25/1-NA-DC-SP	FAZ-C25/2-NA-DC
30	FAZ-C30/1-NA-DC-SP	FAZ-C30/2-NA-DC
32	FAZ-C32/1-NA-DC-SP	FAZ-C32/2-NA-DC
35	FAZ-C35/1-NA-DC-SP	FAZ-C35/2-NA-DC
40	FAZ-C40/1-NA-DC-SP	FAZ-C40/2-NA-DC

#### Note



① Option for single packaging on single-pole C curves only; add suffix SP when ordering.

### Accessories

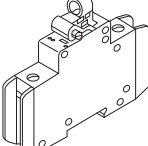
#### FAZ-NA UL 489 Breakers

	Description	Catalog Number
<b>Contact</b> 	Two-pole contact or auxiliary contact/trip indicating contact	<b>Z-NHK</b> ①
<b>Auxiliary Contact</b> 	Auxiliary contact	<b>Z-IHK-NA</b>
<b>Shunt Trip</b>  	Shunt trip 110–415 Vac Shunt trip 12–110 Vac	<b>FAZ-XAA-NA110-415VAC</b> <b>FAZ-XAA-NA12-110VAC</b>
<b>Padlock Hasp</b> 	Padlock hasp	<b>IS/SPE-1TE</b>

#### FAZ-NA UL 489 Breakers, continued

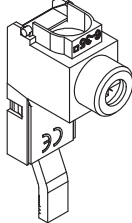
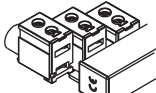
	Description	Catalog Number
<b>Busbar</b> 	Busbar—single-pole, 6 terminals ②③④⑤	<b>Z-SV/UL-16/1P-1TE/6</b>
	Busbar—single-pole, 12 terminals ②③④⑤	<b>Z-SV/UL-16/1P-1TE/12</b>
	Busbar—single-pole, 18 terminals ②③④⑤	<b>Z-SV/UL-16/1P-1TE/18</b>
	Busbar—two-pole, 6 terminals ②③④⑤	<b>Z-SV/UL-16/2P-2TE/6</b>
	Busbar—two-pole, 12 terminals ②③④⑤	<b>Z-SV/UL-16/2P-2TE/12</b>
	Busbar—two-pole, 18 terminals ②③④⑤	<b>Z-SV/UL-16/2P-2TE/18</b>
	Busbar—three-pole, 6 terminals ②③④⑤	<b>Z-SV/UL-16/3P-3TE/6</b>
	Busbar—three-pole, 12 terminals ②③④⑤	<b>Z-SV/UL-16/3P-3TE/12</b>
	Busbar—three-pole, 18 terminals ②③④⑤	<b>Z-SV/UL-16/3P-3TE/18</b>
<b>Busbar Shroud</b> 	Three-pole busbar shroud	<b>ZV-BS-UL</b>
<b>Extension Terminal</b> 	Extension terminal—35 mm <sup>2</sup> (2–14 AWG)	<b>Z-EK/35/UL</b>
<b>Bus Connector</b> 	Bus connector—conductors up to 50 mm <sup>2</sup> (–1/0 AWG)	<b>Z-EB/50/UL</b>

#### Notes

- ① Voltage of FAZ-NA circuit breaker is limited to 300V with this auxiliary contact installed.
- ② Do not cut commoning link.
- ③ A maximum of three commoning links may be used in conjunction. Each breaker connected to the commoning link must have the same number of poles for proper use.
- ④ Not for use with ring-tongue circuit breakers.
- ⑤ Bus may be center fed for high current capacity.

# 1.2

## Miniature Circuit Breakers and Supplementary Protectors

### UL 489 DIN Rail Miniature Circuit Breakers

1

#### Tripping Signal Switch Z-NHK, Z-IHK-NA

- Design according to IEC/EN 60947-5-1, IEC/EN 62019
- Field installable
- The specified minimum voltages are per contact—take into account particularly in case of series connection
- Self-cleaning contacts
- Contact material and design particularly suitable for extra low voltage
- Z-NHK: the function of one of the two change-over contacts can be switched from “auxiliary switch” to “tripping signal switch”
- Tripping signal contact transmits message of electric tripping, not mechanical switch-off
- Test key for contact function “electrical tripping”
- Z-IHK-NA: will allow for > 480Y/277 Vac rating

#### Connection Diagram

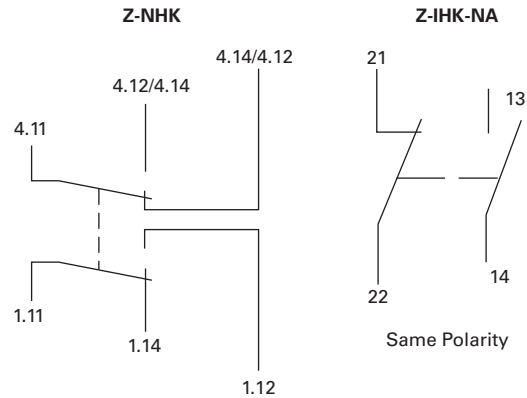

#### Busbar Connection Example

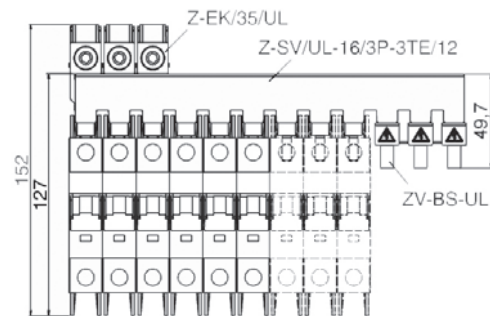



### Technical Data and Specifications

#### Trip Curve Chart

Eaton FAZ-NA branch circuit breakers are available with “B,” “C” and “D” tripping characteristics. B-curve devices are suitable for applications where low levels of inrush current are expected.

C-curve devices are suitable for applications where medium levels of inrush current are expected. Applications include small transformers, lighting, pilot devices, control circuits and coils. C-curve devices provide a medium magnetic trip point.

D-curve devices are suitable for applications where high levels of inrush current are expected. The high magnetic trip point prevents nuisance tripping in high inductive applications such as motors, transformers and power supplies.

Eaton FAZ-NA devices are current limiting, which means they interrupt fault currents within one half cycle of the fault. Current limiting devices offer superior protection by reducing peak let-through current and energy.

#### Tripping Characteristics

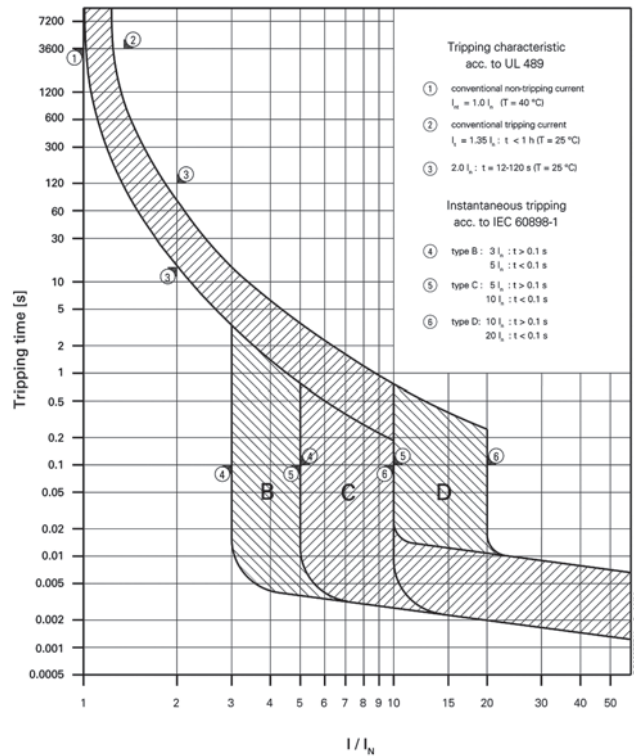

# 1.2

## Miniature Circuit Breakers and Supplementary Protectors

### UL 489 DIN Rail Miniature Circuit Breakers

1

#### Connection Diagrams

Single-Pole



Two-Pole

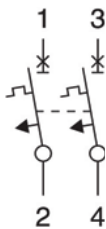

Three-Pole

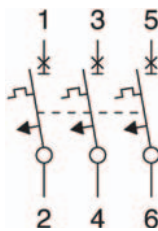

#### Miniature Circuit Breakers FAZ-NA Technical Data

Description	Specification
<b>Electrical</b>	
Design according to	UL 489, CSA C22.2 No.5, IEC 60947-2
Rated voltage FAZ-NA UL/CSA	10 kAIC at 277/480V from 0.5A to 32A 14 kAIC at select amperages B and C Curves (15–25A), D Curve (13–20A)
UL/CSA	10 kAIC at 240 Vac for 35A and 40A
UL/CSA	10 kAIC at 48 Vdc per pole
IEC 947-2	15 kAIC at 240/415 Vac
Rated voltage FAZ-NA-DC UL/CSA	10 kAIC at 125 Vdc per pole (two poles maximum) 10 kAIC at 250 Vdc with two poles connected in series
Rated frequency	50/60 Hz
Characteristic	B, C, D
Endurance	≥ 20,000 operations
Line voltage connection	Suitable for reverse feed
<b>Mechanical</b>	
Frame size	45 mm
Device height	105 mm
Device width	17.7 mm per pole
Terminal protection	Finger and hand touch safe according to BGV A3, OVE-EN 6
Mounting	Quick fastening with two lock-in positions on IEC/EN 60715
Upper and lower terminals	Open mouth/lift terminals
Terminal capacity	One wire: AWG 18–6 Two wires: AWG 18–10
Terminal fastening torque	AWG 18–21: 21 lb-in AWG 10–8: 25 lb-in AWG 6: 36 lb-in
Mounting	Independent of position
Calibration temperature UL 489, CSA C22.2 No.5	40°C
IEC 60947-2	30°C

### Power Loss at $I_n$

$I_n$ [A]	Characteristic B			Characteristic C			Characteristic D		
	Single-Pole P [W]	Two-Pole P [W]	Three-Pole P [W]	Single-Pole P [W]	Two-Pole P [W]	Three-Pole P [W]	Single-Pole P [W]	Two-Pole P [W]	Three-Pole P [W]
0.5	—	—	—	1.6	3.2	4.7	1.6	3.2	4.8
1.0	1.1	2.2	3.4	1.1	2.2	3.4	0.8	1.5	2.3
1.5	2.2	4.4	6.6	1.3	2.6	3.9	1.0	2.1	3.1
2.0	1.4	2.8	4.3	1.4	2.8	4.3	1.0	2.1	3.1
3.0	2.1	4.2	6.4	1.2	2.4	3.6	1.2	2.4	3.6
4.0	1.4	2.9	4.3	1.4	2.9	4.3	1.4	2.9	4.3
5.0	1.8	3.7	5.5	1.9	3.7	5.6	1.5	2.9	4.4
6.0	1.7	3.5	5.2	1.2	2.3	3.5	1.2	2.3	3.5
7.0	2.0	4.0	6.0	1.4	2.8	4.3	1.4	2.8	4.3
8.0	2.0	3.9	5.9	1.4	2.8	4.2	1.2	2.4	3.7
10.0	1.8	3.6	5.3	1.8	3.6	5.3	1.5	3.0	4.5
13.0	2.4	4.7	7.1	2.4	4.7	7.1	2.0	4.1	6.1
15.0	1.9	3.8	5.6	1.9	3.8	5.6	1.5	3.1	4.6
16.0	2.1	4.3	6.4	2.1	4.3	6.4	1.7	3.5	5.2
20.0	2.9	5.8	8.7	2.9	5.8	8.7	1.8	3.7	5.5
25.0	3.1	6.2	9.3	3.1	6.2	9.3	2.6	5.1	7.7
30.0	3.0	6.0	9.0	3.0	6.0	9.0	2.7	5.4	8.1
32.0	3.4	6.8	10.2	3.4	6.8	10.2	3.1	6.2	9.3
35.0	4.0	8.1	12.1	3.7	7.4	11.0	3.8	7.6	11.3
40.0	4.0	8.1	12.1	4.0	8.1	12.1	3.9	7.8	11.6

# 1.2

## Miniature Circuit Breakers and Supplementary Protectors

UL 489 DIN Rail Miniature Circuit Breakers

1

### Let-Through Energy

#### Characteristic B (1–32A), 277V

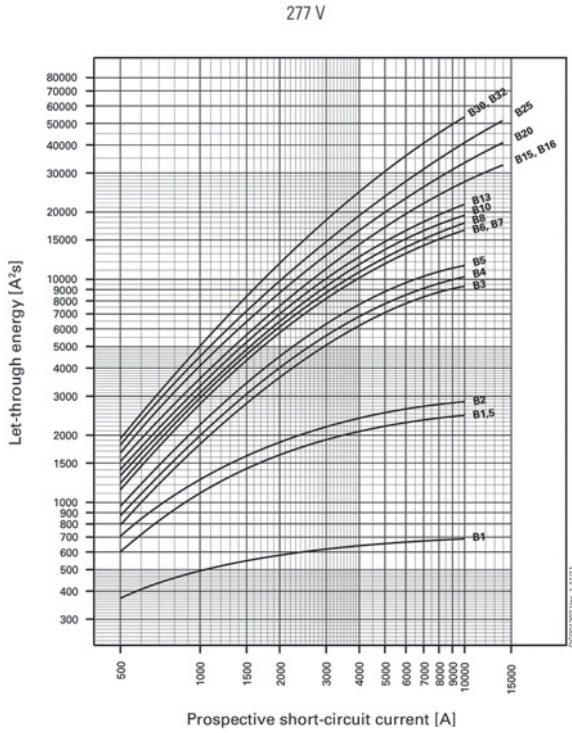

#### Characteristic B (35–40A), 240V

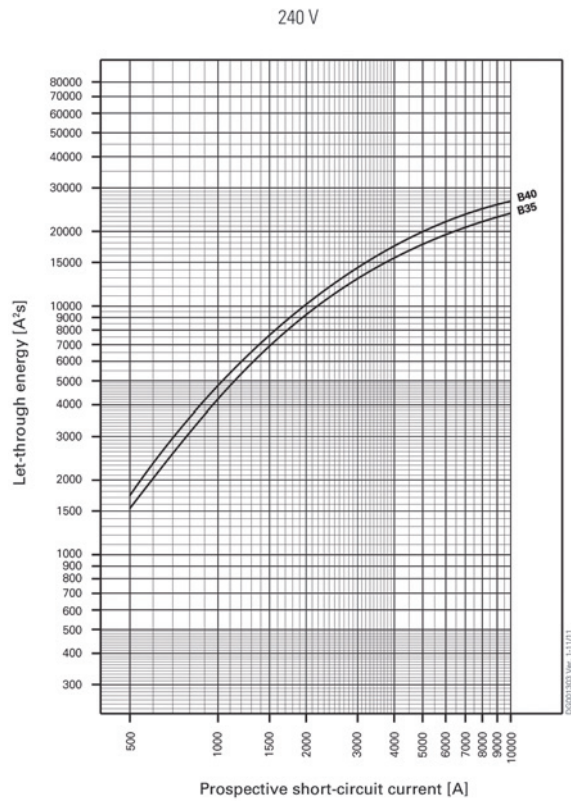

#### Characteristic C (0.5–32A), 277V

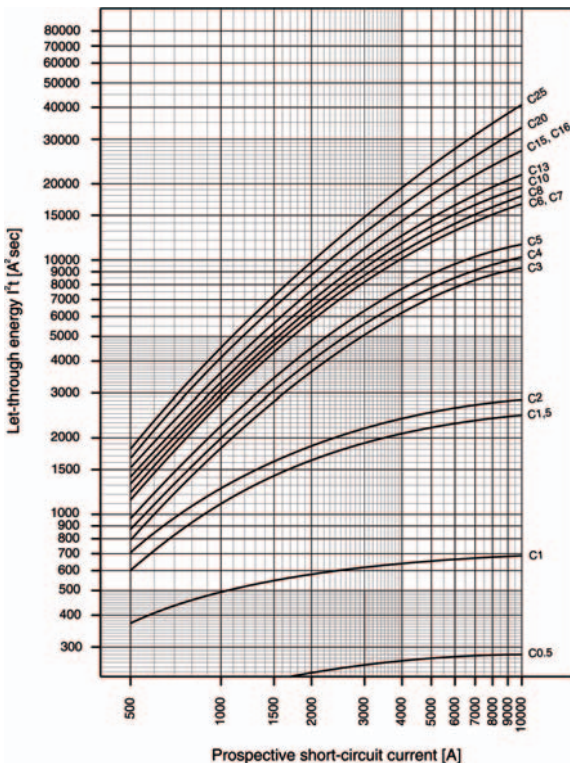

#### Characteristic C (40A), 240V

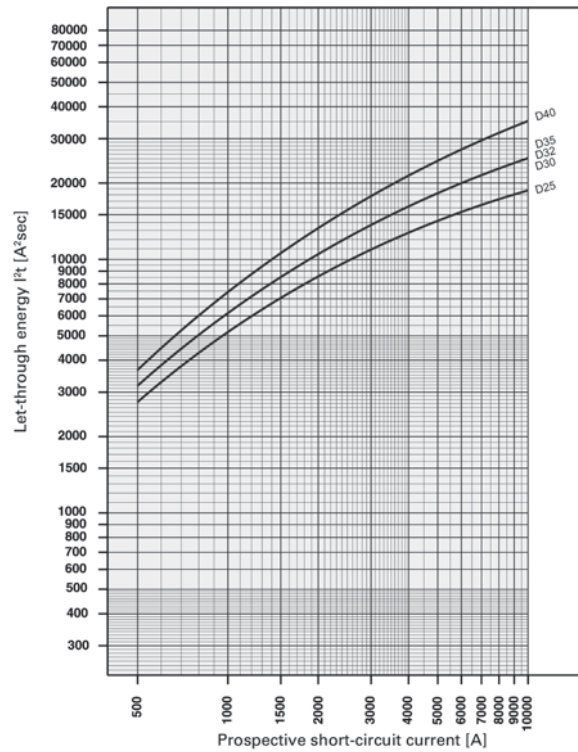

Characteristic D (0.5–32A), 277V

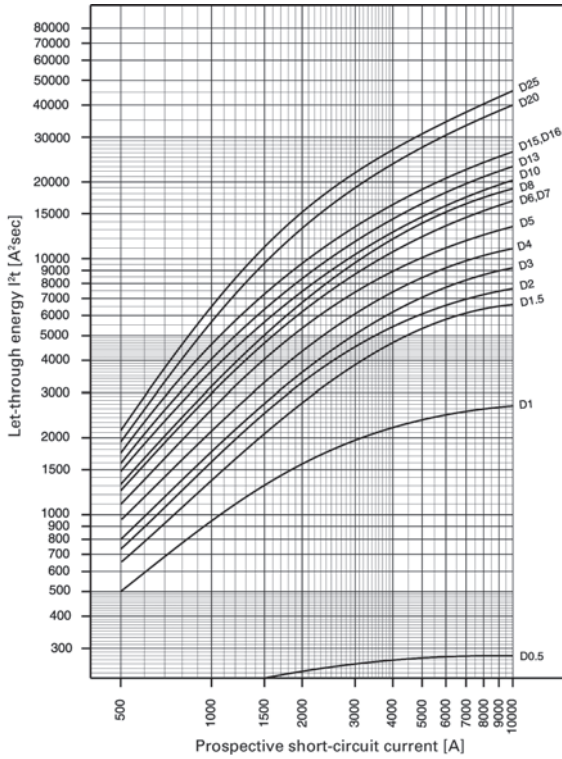

Characteristic D (40A), 240V

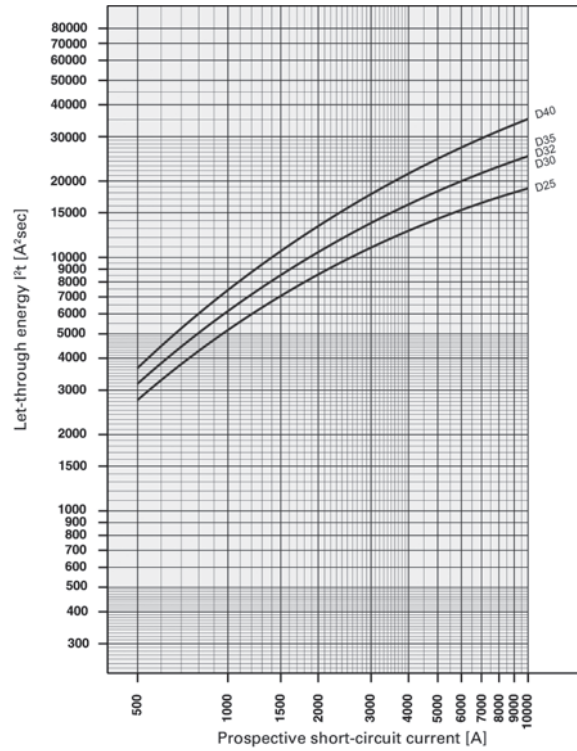

# 1.2

## Miniature Circuit Breakers and Supplementary Protectors

### UL 489 DIN Rail Miniature Circuit Breakers

1

#### Influence of Ambient Temperature T on Load Carrying Capacity

Device Market Current Rating $I_n$ (A) at 40°C	$I_n$ (A) at Higher Ambient Temperature							
	15°C	20°C	25°C	30°C	40°C	50°C	55°C	60°C
0.5	0.6	0.5	0.5	0.5	0.5	0.5	0.5	0.5
1.0	1.1	1.1	1.1	1.0	1.0	1.0	0.9	0.9
1.5	1.7	1.6	1.6	1.6	1.5	1.4	1.4	1.4
2.0	2.2	2.2	2.1	2.1	2.0	1.9	1.9	1.8
3.0	3.3	3.2	3.2	3.1	3.0	2.9	2.9	2.8
4.0	4.4	4.3	4.2	4.2	4.0	3.8	3.8	3.7
5.0	5.5	5.4	5.3	5.2	5.0	4.8	4.7	4.6
6.0	6.6	6.5	6.4	6.2	6.0	5.8	5.6	5.5
7.0	7.7	7.6	7.4	7.3	7.0	6.7	6.6	6.4
8.0	8.8	8.6	8.5	8.3	8.0	7.7	7.5	7.4
10.0	11.0	10.8	10.6	10.4	10.0	9.6	9.4	9.2
13.0	14.3	14.0	13.8	13.5	13.0	12.5	12.5	12.0
15.0	16.5	16.2	15.9	15.6	15.0	14.4	14.1	13.8
16.0	17.6	17.3	17.0	16.6	16.0	15.4	15.0	14.7
20.0	22.0	21.6	21.2	20.8	20.0	19.2	18.8	18.4
25.0	27.5	27.0	26.5	26.0	25.0	24.0	23.3	23.0
30.0	33.0	32.4	31.8	31.2	30.0	28.8	28.2	27.6
32.0	35.2	34.6	33.9	33.3	32.0	30.7	30.1	29.4
40.0	44.0	43.2	42.4	41.6	40.0	38.4	37.6	36.8

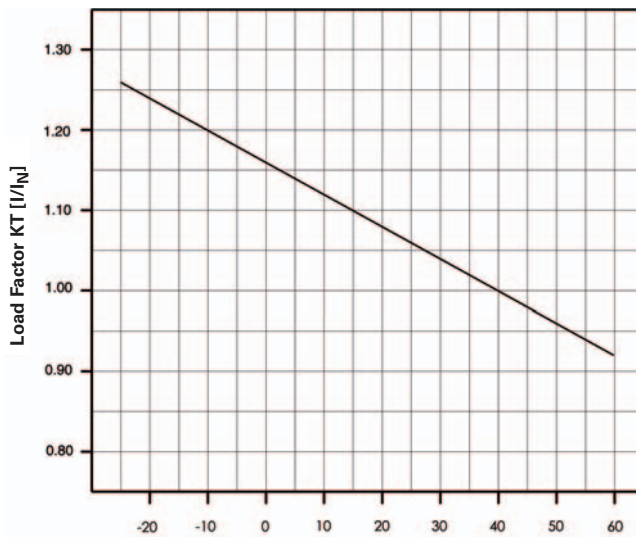

Maximum Load  $I_L$  at ambient temperature T:  $I_L(T) = I_N K_T(T)$

#### Load Carrying Capacity of Adjoining Miniature Circuit Breakers

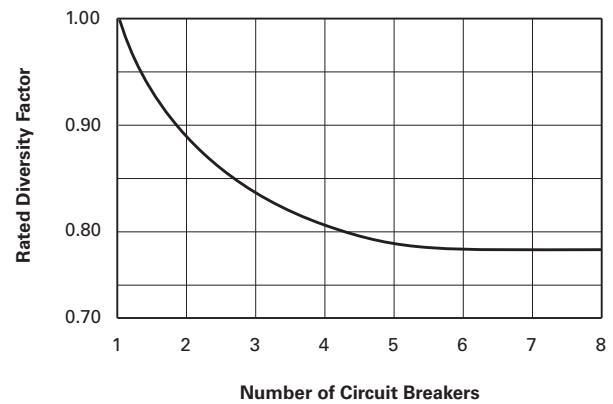

### Z-NHK



### Z-IHK-NA



### Contact and Auxiliary Contact

Description	Z-NHK	Z-IHK-NA
<b>Electrical</b>		
Contact function	2CO	1NO + 1NC
Rated voltage	230V	250V
Frequency	50/60 Hz	50/60 Hz
Rated current	2A	6A
Rated thermal current $I_{th}$	2A	6A
Utilization category AC13 Rated operational current $I_b$	3A/250 Vac	3A/250 Vac
Utilization category AC15 Rated operational current $I_b$	2A/250 Vac	2A/250 Vac
Utilization category DC12 Rated operational current $I_b$	0.5A/110 Vdc	0.5A/110 Vdc 0.25A/220 Vdc
Rated insulation voltage $U_i$	250 Vac	250 Vac
Minimum operational voltage per contact $U_{min}$	5 Vdc	5 Vdc
Minimum operational current $I_{min}$	10 mA DC	10 mA AC/DC
Rated peak withstand voltage $U_{imp}$ (1.2/50 $\mu$ )	2.5 kV	4 kV
Conditional short-circuit current $I_k$ with backup fuse 6A	1 kA	1 kA
Max. backup fuse, overload and short circuit	6A gL	—
<b>Mechanical</b>		
Tripping indicator "electrical tripping"	Blue/white	—
Frame size	45 mm	45 mm
Device height	80 mm	80 mm
Device width	8.8 mm (0.5MU)	8.8 mm (0.5MU)
Mounting	Onto switching device	—
Degree of protection, built-in	IP40	IP40
Terminal protection	Finger and hand touch safe According to BGV A3, ÖVE-EN 6	Finger and hand touch safe According to BGV A3, ÖVE-EN 6
Terminals	Lift terminals	Lift terminals
Terminal capacity	20–14 AWG	0.5–2.5 mm <sup>2</sup>
Terminal screws	M3 (Posidrive Z0)	M3 (Posidrive Z0)
Fastening torque of terminal screws	7 lb-in	Max. 1.2 Nm

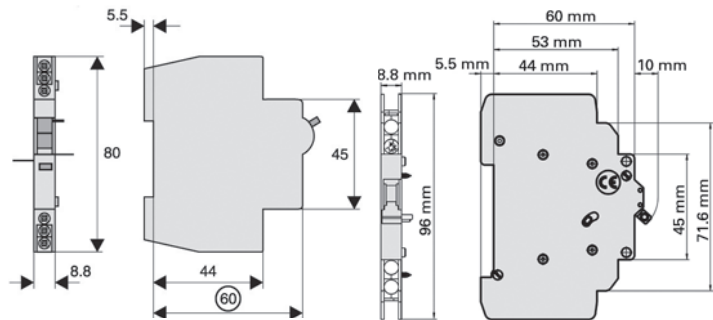

#### Shunt trip release FAZ-XAA-NA

- Remote release for subsequent mounting onto FAZ-NA/RT
- Additional installation of standard auxiliary switch is possible
- Position indicator red-green

#### Connection Diagram

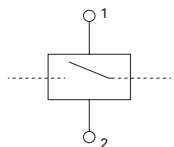

#### Shunt Trip Release FAZ-XAA-NA

Description	FAZ-XAA-NA12-110VAC	FAZ-XAA-NA110-415VAC
<b>Electrical</b>		
Can be mounted onto	FAZ-NA / FAZ-NA-DC / FAZ-RT	FAZ-NA / FAZ-NA-DC / FAZ-RT
Operational voltage range	12–110 Vac 12–60 Vdc	110–415 Vac 110–230 Vdc
Frequency	50/60 Hz	50/60 Hz
<b>Mechanical</b>		
Frame size	45 mm	45 mm
Device height	105 mm	105 mm
Device width	17.5 mm	17.5 mm
Mounting	Quick fastening with two lock-in positions on EN 50022	
Degree of protection, built-in	IP40	IP40
Terminal protection	Finger and hand touch safe according to BGV A3, ÖVE-EN 6	
Terminals	Open mouthed/lift	Open mouthed/lift
Terminal capacity One and two wires	18–10 AWG	18–10 AWG

#### Busbar block UL 489 (pin)

- Tested according to UL 489
- Do not cut
- Extension terminal 35 mm<sup>2</sup> Z-EK/35/UL for copper conductors
- Incoming terminal 50 mm<sup>2</sup> Z-EB/50/UL
- For covering of not used pins, use busbar tag shrouds ZV-BS-UL

#### Connection Diagrams

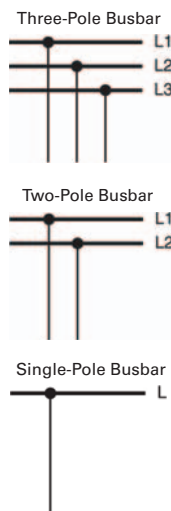

#### Busbar Block UL 489 (Pin)

Description	UL 489	IEC/EN 60947-2
<b>Electrical</b>		
Rated operational voltage	480/277 Vac 96 Vdc	—
Rated frequency	50/60 Hz	—
Rated voltage	480 Vac	690 Vac
Overvoltage category	—	III
Rated impulse withstand voltage U <sub>imp</sub>	—	9.5 kV
Rated current	80A at 40°C	80A at 30°C
Rated conditional short-circuit current AC with 350A gG	—	15 kA
Short-circuit current	10 kA	—
<b>Mechanical</b>		
Busbar cross section	—	16 mm <sup>2</sup> Cu
Flame class according to UL 94	V0	—
Pollution degree	—	2
Comparative tracking index	—	CTI 600
Minimum clearance (internal/external)	—	> 9.5/25.4 mm
Minimum creepage distance (internal/external)	—	> 12.7/50.8 mm
Resistance to climatic conditions	—	According to DIN/EN 60068



### Application Guidelines

#### Example of UL 489 and UL 1077 Application

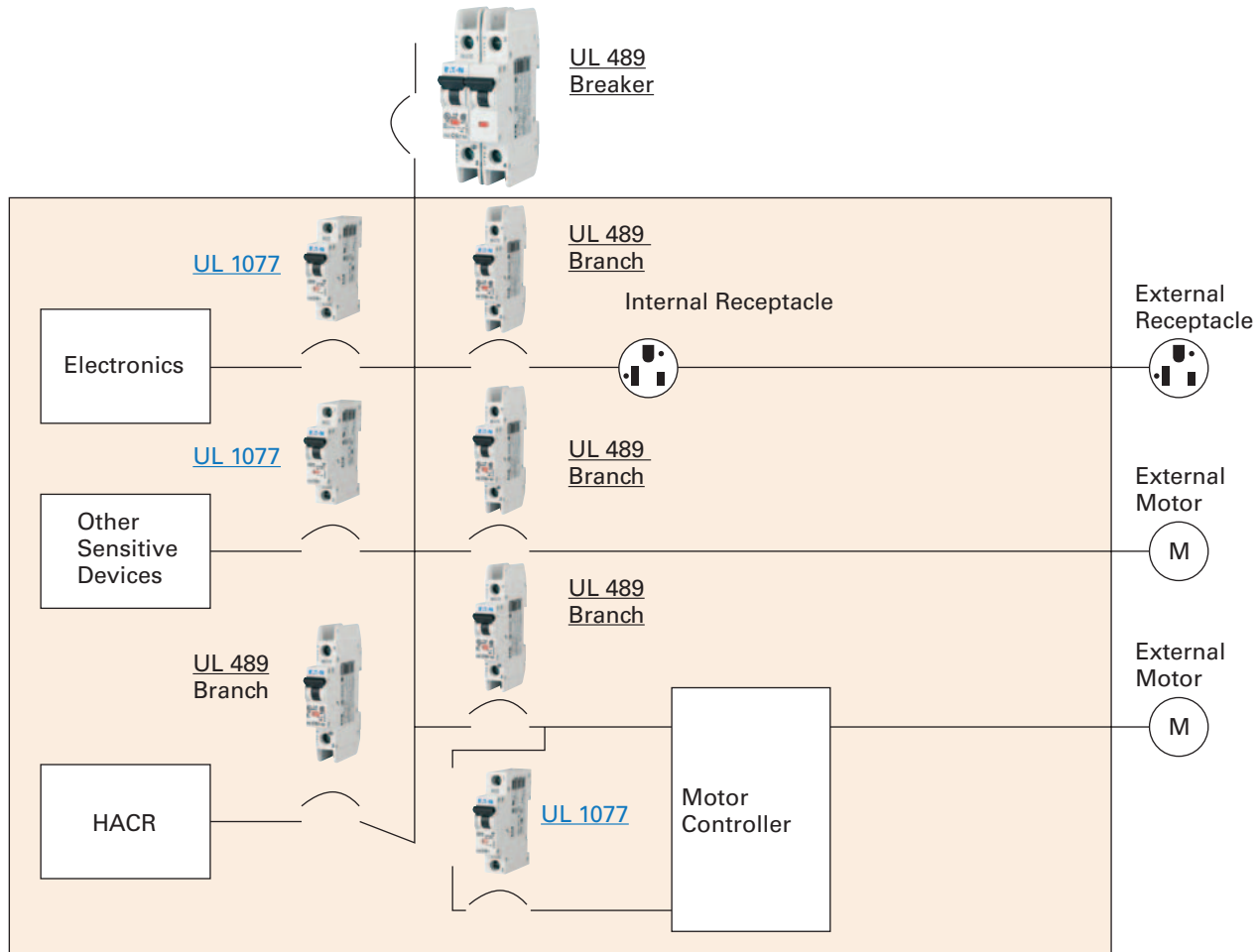

Example of UL 489 and UL 1077 Application

#### UL 489 circuit breakers

Used for branch circuit protection, internal/external receptacles, external motors and HACR equipment (heating, air conditioning and refrigeration).

#### UL 1077 supplementary protectors

Used for overcurrent protection within appliances or electrical equipment, where branch circuit protection is already provided or not required.

**Note:** UL 489 devices can be used in place of UL 1077; UL 1077 devices cannot be used in place of UL 489.

# 1.2

## Miniature Circuit Breakers and Supplementary Protectors

### UL 489 DIN Rail Miniature Circuit Breakers

1

#### Dimensions

Approximate Dimensions in Inches (mm)

#### Miniature Circuit Breakers

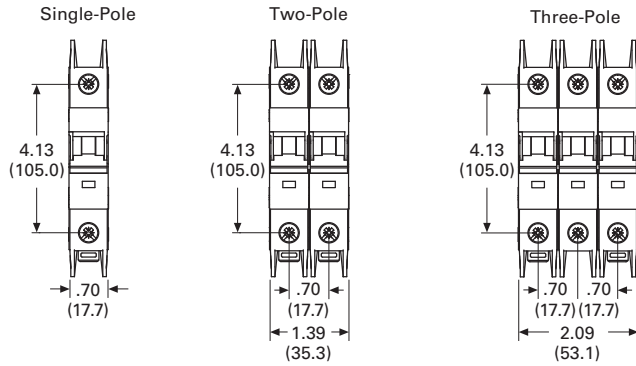

#### Lockout Attachment—IS/SPE-ITE

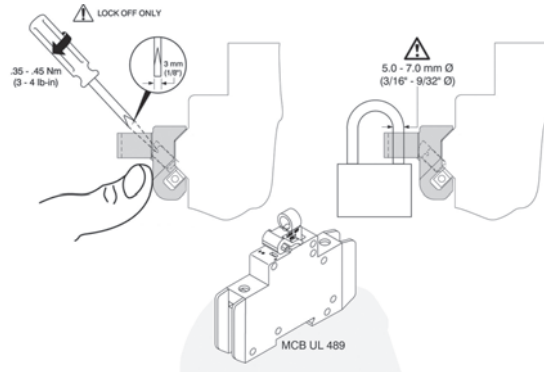

#### Accessories

##### Z-SV/UL-16/6

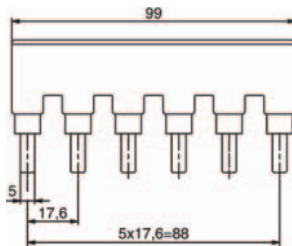

##### Z-SV/UL-18...12

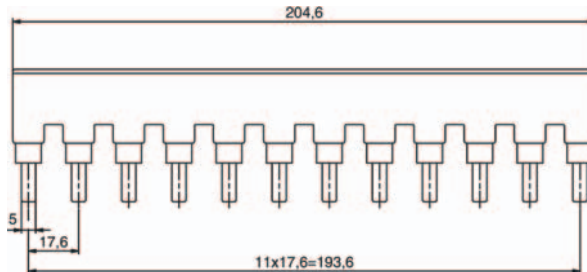

##### ZV-BS-UL

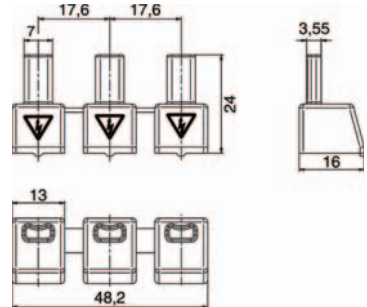

##### Z-SV/UL-16.../18

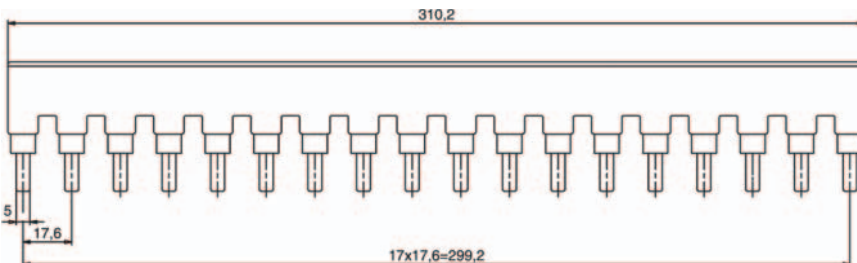

##### Z-EK/35/UL

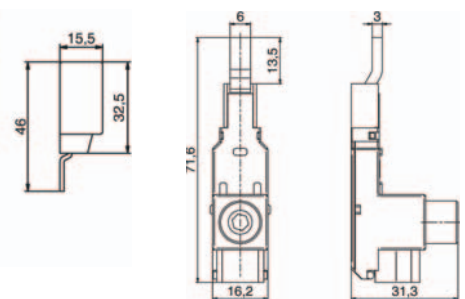

#### Z-EK/35/UL

Description	UL 489	IEC/EN 60947-2
$U_e$	480 Vac/96 Vdc	240/415 Vac
$f$	50/60 Hz	50/60 Hz
$U_{imp}$	—	9.5 kV
$I_e$	80A at 40°C	80A at 30°C
	#2-14 AWG 60/75°C Cu	2.5-35 mm <sup>2</sup> Cu
	0.56 in	14 mm

#### Z-EB/50/UL

Description	UL 489	IEC/EN 60947-2
$U_e$	480 Vac/96 Vdc	240/415 Vac
$f$	50/60 Hz	50/60 Hz
$U_{imp}$	—	9.5 kV
$I_e$	115A at 40°C	160A at 30°C
	#1-14 AWG 60/75°C Cu	1.5-50 mm <sup>2</sup> Cu
	0.56 in	14 mm