



Connectors for consumer electronics



MAS/MAK-series

HiMedia

Product description

Shielded miniature multipole connectors, 3- pole to 8-pole.

- Numerous different versions ensure a variety of uses in audio- and video equipment, measurement and control instruments, on projectors and in the computer technology

- Safe connection of connector, couplings, panel-mounted sockets and panel-mounted connectors with screw locking system
- All cable connectors feature clamping tabs to relieve the strain
- UM types as standard, but industry package, quantity boxed: 1000 units

Basic data

Operating voltage: 34 V AC / DC







Operating current: 4 A

Flashover voltage: 1 kV

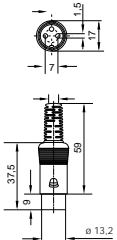
Insulation resistance: $10^{11} \Omega$

Type of connection: solder

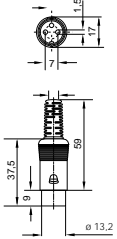
Plug illustrations: EN 60130-9

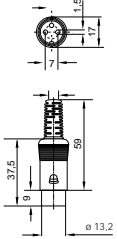
Type		Number of poles	Description	Colour	Order no.
 <p>MAS 30 MAS 30 UM</p>		3	Connector with insulated handle, solder connection	grey UM black UM grey	930 014-517 931 002-100 931 002-117
 <p>MAS 40 MAS 40 UM</p>		4	Connector with insulated handle, solder connection	grey UM grey	930 015-517 931 018-117
 <p>MAS 50 MAS 50 UM</p>		5	Connector with insulated handle, solder connection	grey UM black UM grey	930 016-517 931 034-100 931 034-117
 <p>MAS 50 S MAS 50 S UM</p>		5	Connector with insulated handle, solder connection	black grey UM black UM grey	930 131-500 930 131-517 931 036-100 931 036-117

Connectors for consumer electronics

MAS/MAK-series

HiMedia



Type		Number of poles	Description	Colour	Order no.
 MAS 50 W		5	Connector with insulated handle, solder connection	grey	930 805-517
 MAS 60 MAS 60 UM		6	Connector with insulated handle, solder connection	black grey UM black UM grey	930 017-500 930 017-517 931 044-100 931 044-117
 MAS 70 S MAS 70 S UM		7	Connector with insulated handle, solder connection	black grey UM black UM grey	930 356-500 930 356-517 931 050-100 931 050-117
 MAS 80 S MAS 80 S UM		8	Connector with insulated handle, solder connection	black grey UM black UM grey	930 298-500 930 298-517 931 183-100 931 183-117
 MAS 80 SN MAS 80 SN UM		8	Connector with insulated handle, solder connection	black grey black UM grey UM	931 518-500 931 518-517 931 521-100 931 521-117



Connectors for consumer electronics



MAS/MAK-series

HiMedia







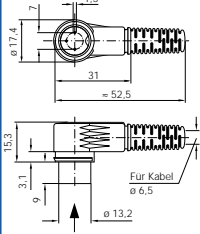

Type		Number of poles	Description	Colour	Order no.
 <p>MAWI 30 B MAWI 30 B UM</p>		<p>3</p> 	<p>Angled connector with insulated handle, solder connection</p>	<p>grey UM black UM grey</p>	<p>931 597-517 931 621-100 931 621-117</p>
 <p>MAWI 40 B</p>		<p>4</p> 	<p>Angled connector with insulated handle, solder connection</p>	<p>grey</p>	<p>931 567-517</p>
 <p>MAWI 50 B</p>		<p>5</p> 	<p>Angled connector with insulated handle, solder connection</p>	<p>grey</p>	<p>931 569-517</p>
 <p>MAWI 50 SB MAWI 50 SB UM</p>		<p>5</p> 	<p>Angled connector with insulated handle, solder connection</p>	<p>grey UM black UM grey</p>	<p>931 571-517 931 572-100 931 572-117</p>
 <p>MAWI 60 B MAWI 60 B UM</p>		<p>6</p> 	<p>Angled connector with insulated handle, solder connection</p>	<p>grey UM black UM grey</p>	<p>931 573-517 931 574-100 931 574-117</p>

Connectors for consumer electronics

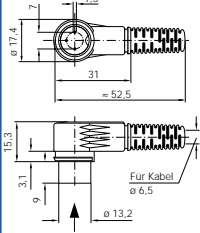
MAS/MAK-series

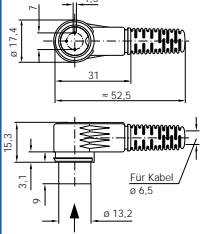
HiMedia

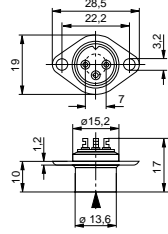

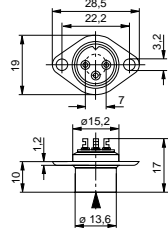
Type		Number of poles	Description	Colour	Order no.
		7	Angled connector with insulated handle, solder connection	grey	931 575-517
		8	Angled connector with insulated handle, solder connection	grey UM black UM black	931 740-517 931 741-100 931 741-117
		8	Angled connector with insulated handle, solder connection	grey UM black UM grey	931 577-517 931 578-100 931 578-117
		3	Panel-mounted connector with flange, solder connection, die-cast casing and and flange, nickel-plated		930 063-500
		5	Panel-mounted connector with flange, solder connection, die-cast casing and and flange, nickel-plated		930 934-500



Connectors for consumer electronics



MAS/MAK-series

HiMedia





Type		Number of poles	Description	Colour	Order no.
 MAK 30 S MAK 30 S UM		3	Coupling with insulated handle, solder connection	grey UM grey	930 149-517 931 080-117
 MAK 40 MAK 40 UM		4	Coupling with insulated handle, solder connection	grey UM black UM grey	930 150-517 931 086-100 931 086-117
 MAK 50		5	Coupling with insulated handle, solder connection	grey	930 151-517
 MAK 50 S MAK 50 S UM		5	Coupling with insulated handle, solder connection	grey UM black UM grey	930 172-517 931 092-100 931 092-100
 MAK 60 MAK 60 UM		6	Coupling with insulated handle, solder connection	grey UM black	930 152-517 931 100-100

Connectors for consumer electronics

MAS/MAK-series

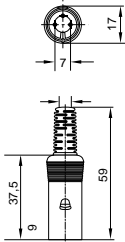
HiMedia

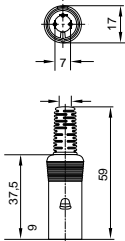

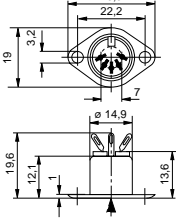
Type		Number of poles	Description	Colour	Order no.
 MAK 70 S		7	Coupling with insulated handle, solder connection	grey	930 388-517
 MAK 80 S		8	Coupling with insulated handle, solder connection	grey	930 348-517
 MAK 80 SN		8	Coupling with insulated handle, solder connection	grey	931 519-517
 MAB 3 S		3	Panel-mounted socket with flange	black	930 018-200
 MAB 4		4	Panel-mounted socket with flange	black	930 009-200





Connectors for consumer electronics

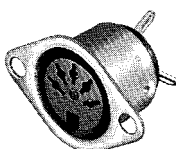
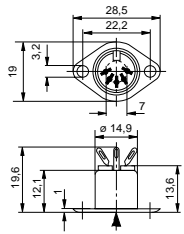

MAS/MAK-series

HiMedia

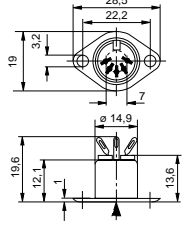
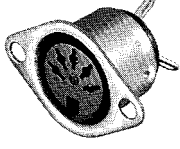
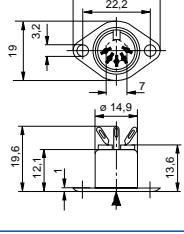
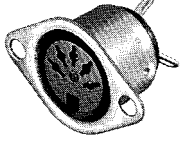
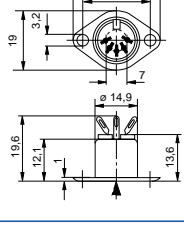
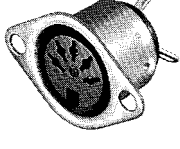
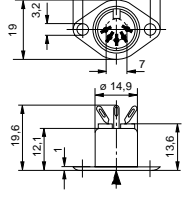





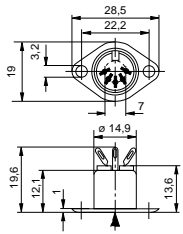

Type		Number of poles	Description	Colour	Order no.
 MAB 5		5	Panel-mounted socket with flange	black	930 010-200
 MAB 5 S		5	Panel-mounted socket with flange	black	930 071-200
 MAB 6		6	Panel-mounted socket with flange	black	930 011-200
 MAB 7 S		7	Panel-mounted socket with flange	black	930 343-200
 MAB 8 S		8	Panel-mounted socket with flange	black	930 345-200

Connectors for consumer electronics

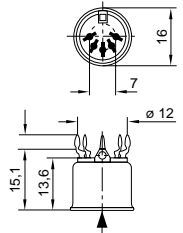
MAS/MAK-series

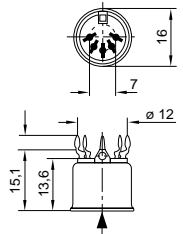
HiMedia

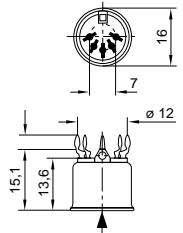

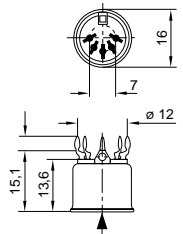
Type		Number of poles	Description	Colour	Order no.
 MAB 8 SN		8	Panel-mounted socket with flange	black	931 613-200
 MAB 5 SV		5	Panel-mounted socket for printed circuits, Plug-in direction perpendicular to the circuit board	black	930 777-200
 MAB 6 V		6	Panel-mounted socket for printed circuits, Plug-in direction perpendicular to the circuit board	black	930 812-200
 MAB 7 SV		7	Panel-mounted socket for printed circuits, Plug-in direction perpendicular to the circuit board	black	931 657-200
 MAB 8 SN V		8	Panel-mounted socket for printed circuits, Plug-in direction perpendicular to the circuit board	black	932 664-200

Connectors for consumer electronics

MAS/MAK-series

HiMedia

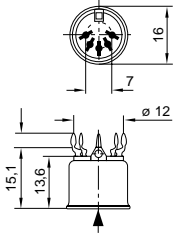
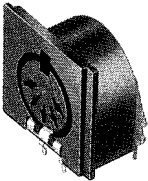
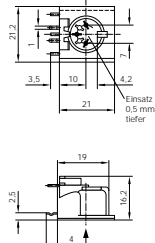
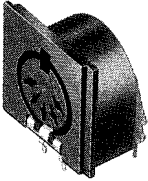
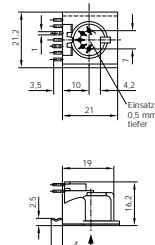
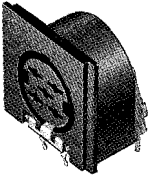
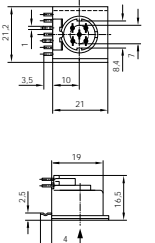
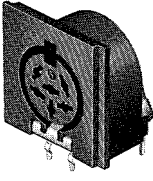
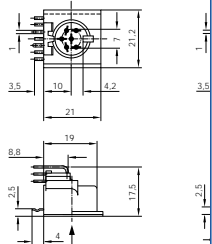



Type		Number of poles	Description	Colour	Order no.
		8	Panel-mounted socket for printed circuits, Plug-in direction perpendicular to the circuit board	black	931 735-200
		3	Panel-mounted socket for printed circuits, Plug-in direction parallel to the circuit board, Board thickness 1,5 mm	black	930 360-200
		5	Panel-mounted socket for printed circuits, Plug-in direction parallel to the circuit board, Board thickness 1,5 mm	black	931 744-200
		5	Panel-mounted socket for printed circuits, Plug-in direction parallel to the circuit board, Board thickness 1,5 mm	black	930 236-200
		6	Panel-mounted socket for printed circuits, Plug-in direction parallel to the circuit board, Board thickness 1,5 mm	black	930 778-200

Connectors for consumer electronics

MAS/MAK-series

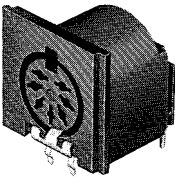
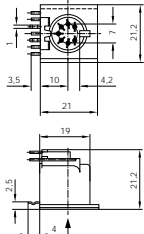
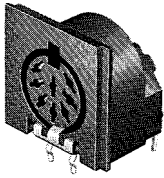
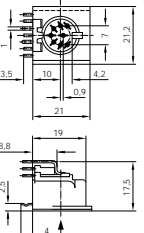
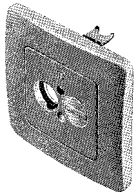
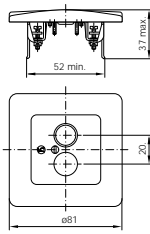
HiMedia

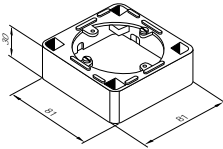

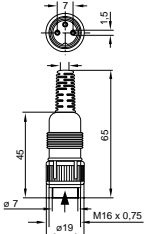
Type		Number of poles	Description	Colour	Order no.
 <p>MAB 7 SH-L</p>		7	Panel-mounted socket for printed circuits, Plug-in direction parallel to the circuit board, Board thickness 1,5 mm	black	930 518-200
 <p>MAB 8 SH</p>		8	Panel-mounted socket for printed circuits, Plug-in direction parallel to the circuit board, Board thickness 1,5 mm	black	931 399-200
 <p>MABU LD-V</p>		–	Connecting socket for 58 mm panel-mounted sockets, can be equipped with flanged panel-mounted sockets, e.g. MAB 5S	ivory	930 698-108
 <p>AR 20</p>		–	Surface-mounted frame for MABU LD-V	ivory	933 650-001
 <p>MAS 3100 MAS 3100 UM</p>		3	Connector with locking screw, solder connection	grey UM grey	930 304-517 931 068-117









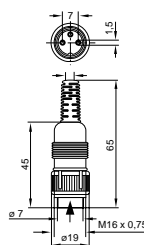

Connectors for consumer electronics

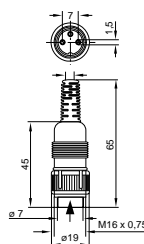

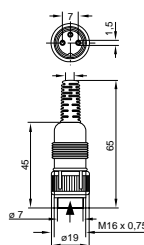
MAS/MAK-series

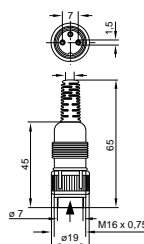
HiMedia

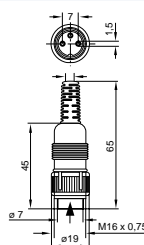

Type		Number of poles	Description	Colour	Order no.
 MAS 4100 MAS 4100 UM		4	Connector with locking screw, solder connection	grey UM black UM grey	930 963-517 931 173-100 931 173-117
 MAS 5100 MAS 5100 UM		5	Connector with locking screw, solder connection	grey UM black UM grey	930 964-517 931 189-100 931 189-117
 MAS 5100 S MAS 5100 S UM		5	Connector with locking screw, solder connection	grey UM grey	930 965-517 931 174-117
 MAS 6100 MAS 6100 UM		6	Connector with locking screw, solder connection	grey UM grey	930 966-517 931 151-117
 MAS 7100 S MAS 7100 S UM		7	Connector with locking screw, solder connection	grey UM grey	930 688-517 930 689-117

Connectors for consumer electronics

MAS/MAK-series

HiMedia

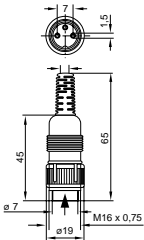

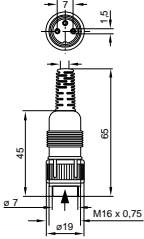
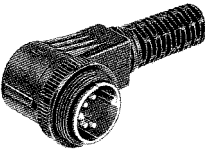
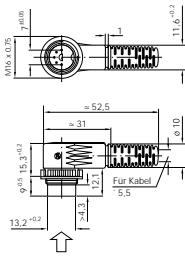
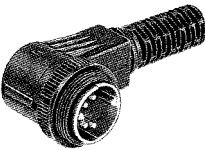
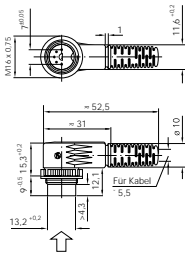
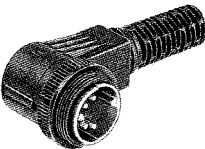
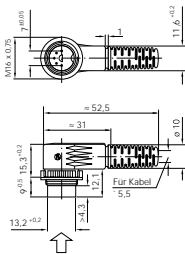
Type		Number of poles	Description	Colour	Order no.
 MAS 8100 S		8	Connector with locking screw, solder connection	grey UM black UM grey	930 539-517 931 240-100 931 240-117
 MAS 8100 SN UM		8	Connector with locking screw, solder connection	UM black UM grey	931 750-100 931 750-117
 MAWI 3100		3	Angled connector with locking screw, solder connection	grey	932 906-117
 MAWI 4100		4	Angled connector with locking screw, solder connection	grey	932 907-117
 MAWI 5100		5	Angled connector with locking screw, solder connection	grey	932 908-117







Connectors for consumer electronics

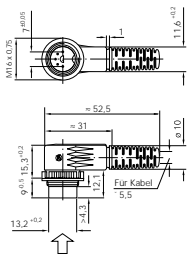
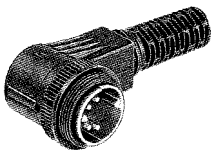
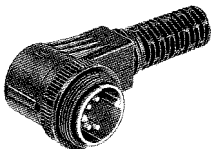
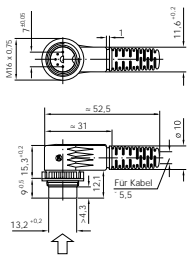

MAS/MAK-series

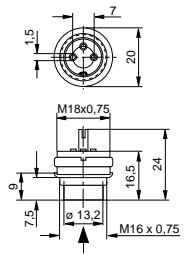
HiMedia

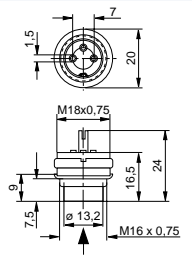





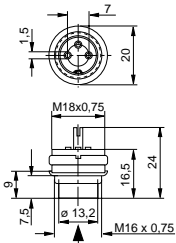

Type		Number of poles	Description	Colour	Order no.
 <p>MAWI 5100 S</p>		5	Angled connector with locking screw, solder connection	grey	932 909-117
 <p>MAWI 6100</p>		6	Angled connector with locking screw, solder connection	grey	932 910-117
 <p>MAWI 8100 S</p>		8	Angled connector with locking screw, solder connection	grey	932 912-117
 <p>MASEI 3100</p>		3	Panel-mounted connector with locking screw, solder connection	grey	930 296-517
 <p>MASEI 4100</p>		4	Panel-mounted connector with locking screw, solder connection	grey	930 955-517

Connectors for consumer electronics

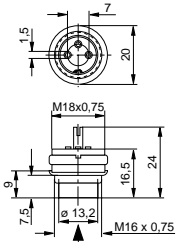
MAS/MAK-series

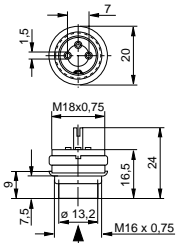
HiMedia

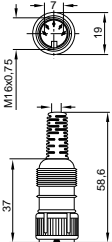

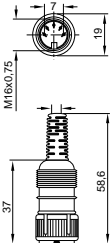
Type		Number of poles	Description	Colour	Order no.
 MASEI 5100		5	Panel-mounted connector with locking screw, solder connection	grey	930 956-517
 MASEI 5100 S		5	Panel-mounted connector with locking screw, solder connection	grey	930 957-517
 MASEI 6100		6	Panel-mounted connector with locking screw, solder connection	grey	930 958-517
 MAK 3100 S MAK 3100 S UM		3	Coupling with locking screw, solder connection	grey UM grey	930 764-517 931 110-117
 MAK 4100 MAK 4100 UM		4	Coupling with locking screw, solder connection	grey UM black UM grey	930 959-517 931 175-100 931 175-117









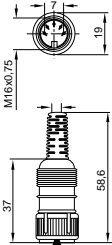

Connectors for consumer electronics

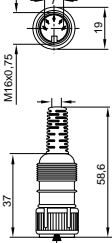

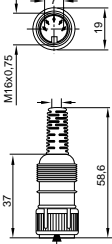
MAS/MAK-series

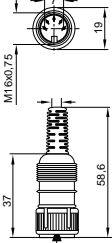
HiMedia

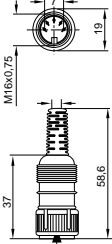





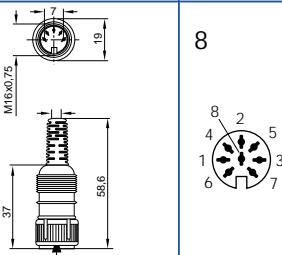

Type		Number of poles	Description	Colour	Order no.
 MAK 5100 MAK 5100 UM		5	Coupling with locking screw, solder connection	grey UM black UM grey	930 960-517 931 176-100 931 176-117
 MAK 5100 S MAK 5100 S UM		5	Coupling with locking screw, solder connection	grey UM black UM grey	930 961-517 931 177-100 931 177-117
 MAK 6100 MAK 6100 UM		6	Coupling with locking screw, solder connection	grey UM grey	930 962-517 931 178-117
 MAK 7100 S MAK 7100 S UM		7	Coupling with locking screw, solder connection	grey UM grey	930 682-517 930 690-117
 MAK 8100 S MAK 8100 S UM		8	Coupling with locking screw, solder connection	grey UM black UM grey	930 538-517 931 127-100 931 127-117

Connectors for consumer electronics

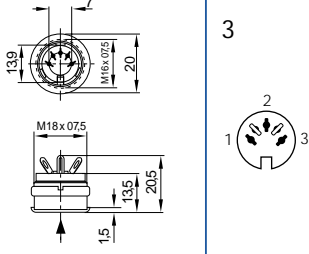
MAS/MAK-series

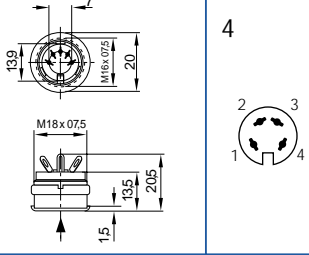
HiMedia

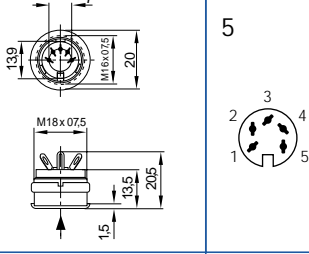

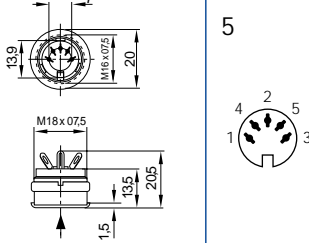
Type		Number of poles	Description	Colour	Order no.
 MAK 8100 SN UM		8	Coupling with locking screw, solder connection	UM black UM grey	931 765-100 931 765-117
 MAB 3100 S		3	Panel-mounted socket with locking screw, solder connection, not shielded	black grey	930 303-500 930 303-517
 MAB 4100		4	Panel-mounted socket with locking screw, solder connection, not shielded	grey	930 951-517
 MAB 5100		5	Panel-mounted socket with locking screw, solder connection, not shielded	grey	930 952-517
 MAB 5100 S		5	Panel-mounted socket with locking screw, solder connection, not shielded	black grey	930 953-500 930 953-517









Connectors for consumer electronics

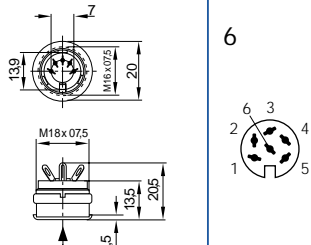

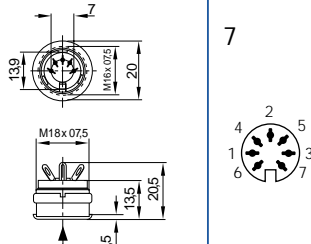
MAS/MAK-series

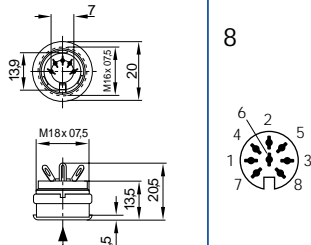
HiMedia

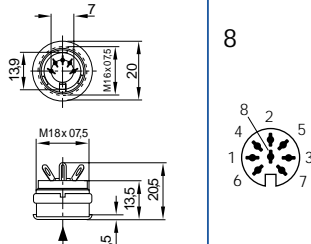
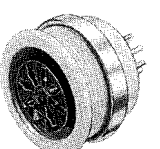
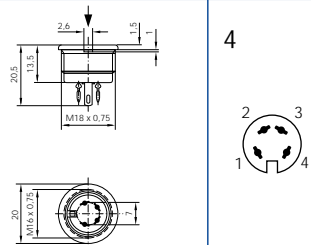
Type		Number of poles	Description	Colour	Order no.
		6	Panel-mounted socket with locking screw, solder connection, not shielded	black grey	930 954-500 930 954-517
		7	Panel-mounted socket with locking screw, solder connection, not shielded	grey	931 351-517
		8	Panel-mounted socket with locking screw, solder connection, not shielded	grey	930 537-517
		8	Panel-mounted socket with locking screw, solder connection, not shielded	black grey	931 749-500 931 749-517
		4	Panel-mounted socket with locking screw, for print assembly, solder connection, not shielded	grey	932 254-517

Connectors for consumer electronics

MAS/MAK-series

HiMedia



Type		Number of poles	Description	Colour	Order no.
 MAB 5100 SV		5 	Panel-mounted socket with locking screw, for print assembly, solder connection, not shielded	grey	932 201-517
 MAB 6100 V		6 	Panel-mounted socket with locking screw, for print assembly, solder connection, not shielded	grey	932 202-517
 MAB 7100 SV		7 	Panel-mounted socket with locking screw, for print assembly, solder connection, not shielded	grey	932 423-517
 MAB 8100 SV		8 	Panel-mounted socket with locking screw, for print assembly, solder connection, not shielded	grey	932 203-517
 MAB 4500 V		4 	Panel-mounted socket with locking screw, for installation in rear panels; max. 4 mm, solder connection, not shielded	grey	933 053-517







Connectors for consumer electronics

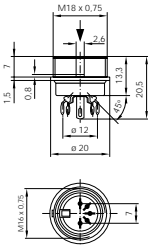

MAS/MAK-series

HiMedia

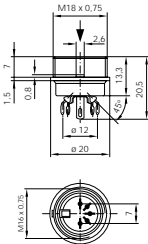
Type		Number of poles	Description	Colour	Order no.
 <p>MAB 5500 SV</p>		5	Panel-mounted socket with locking screw, for installation in rear panels; max. 4 mm, solder connection, not shielded	black grey	932 885-500 932 885-517
 <p>MAB 8500 SV</p>		8	Panel-mounted socket with locking screw, for installation in rear panels; max. 4 mm, solder connection, not shielded	grey	933 141-517
 <p>MAB 8500 SN V</p>		8	Panel-mounted socket with locking screw, for installation in rear panels; max. 4 mm, solder connection, not shielded	grey	933 058-517

