



crydom[®]

The Global Expert in **Solid State Switching** Technology

A brand of
CST
CUSTOM SENSORS & TECHNOLOGIES



ABOUT US

Crydom, a brand of Custom Sensors & Technologies (CST) and **global expert in Solid State Relay Technology**, has a distinguished record of providing high quality, world class Solid State Relay and Control Products for a variety of heating, lighting and motion control applications. Crydom products, coupled with **unparalleled technical support, timely delivery and competitive pricing**, provide Crydom's clients with the innovative products and support necessary to succeed in today's competitive and fast paced global markets.

Crydom's extensive selection of standard off-the-shelf products is constantly being updated and expanded through its continuous improvement and aggressive new product development programs. Utilizing state of the art designs, materials and technology, Crydom offers a wide range of AC and DC output SSRs and solid state contactors in industry standard Panel Mount, PCB Mount, DIN Rail and Plug-In packages, all **meeting global safety and standards agency requirements** such as CE, RoHS, UL, IEC, etc.

Bolstered by four decades of Solid State Relay operations experience, Crydom also specializes and encourages **adapted and fully custom-designed SSR products** for nearly any application where unique specifications and optimized performance are critical for success.

Crydom's modern purpose-built **100,000 square foot manufacturing facility** houses all aspects of its ISO certified operation including Design and Development Engineering, Manufacturing Operations and Quality Assurance, Customer Service, Finance, Marketing and General Management, permitting close coordination of all aspects of Crydom's activities. Applications Engineering and Sales support are both performed in the field to provide Crydom's Customers with the unparalleled technical and commercial support.

Following rigid design guidelines and standards, Crydom products have set the bench mark for SSR performance and reliability world wide. In addition to **award winning designs**, Crydom has acquired an impressive list of **patents** related to SSRs and Solid State Controls, while continuing to develop new circuit and technology-related inventions as part of **extensive R&D programs**.

To learn more about Crydom SSR technology and products, or how an alliance with Crydom can contribute to the success of your project, visit **www.crydom.com** or contact your authorized Crydom Distributor or Crydom Customer Service Representative today.

DIN RAIL MOUNTED AC & DC OUTPUT SOLID STATE RELAY TIMERS

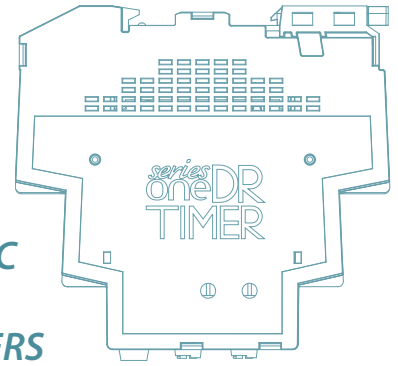

SeriesOne DR Single Channel AC & DC Output Multifunction Timers

Crydom's proprietary thermal management technology and proven Solid State Relay expertise are now combined with advanced uP based timing in the new **SeriesOne DR Timer** line. Offering models with exceptional Solid State output ratings of either 6 amp AC or DC and 8 different precision timing functions with 18 variations the new **SeriesOne DR Timer** line is housed in a compact 11 mm wide DIN Rail mounted package designed for the direct control of a wide variety of resistive and inductive loads.

Multifunction Solid State Relay Timing with Superior Output Ratings

Ideal for use in control panels for direct control of contactors, solenoids, motors, heaters, lights, etc., the **SeriesOne DR Timer** series is available with either 6 amp/24 to 280 VAC output rating or 6 amp/1 to 60 VDC output rating, both at 40°C ambient temperature.... ratings well in excess of most Solid State Relay Output Timers in the market today, therefore allowing direct control of many loads thus eliminating the need for interfacing power relays often required for use with lower power timers.

Available timing functions include "A" & "At" delay on make, "B" single shot, "C" delay on break, "H" & "Ht" interval, "L" & "Li" repeat cycle, and "U" multifunction that includes A, At, Ac, B, Bw, C, D, Di, H, and Ht functions. Basic timing function selection is user settable via screw slot rotary switches on the side of the **SeriesOne DR Timers**, while unit and fine timing adjustments are made on the front panel of the Timers. This arrangement provides easy access to Technicians for simple timing adjustments but significantly reduces accidental changes to the basic function.

Versatile Control

Control for the **SeriesOne DR Timers**, depending on model, is 12 to 24 VAC/DC for all models, with options of either 90 to 140 VAC or 180 to 240 VAC for AC outputs only. All Crydom **SeriesOne DR Timers** are UL listed and cUL recognized, UL Motor Control rated, RoHS and China RoHS compliant, and CE certified to the Low Voltage and EMC Directives.

For more information, technical support or questions about adapted assemblies, contact your local Crydom Distributor, Regional Sales Office or www.crydom.com.

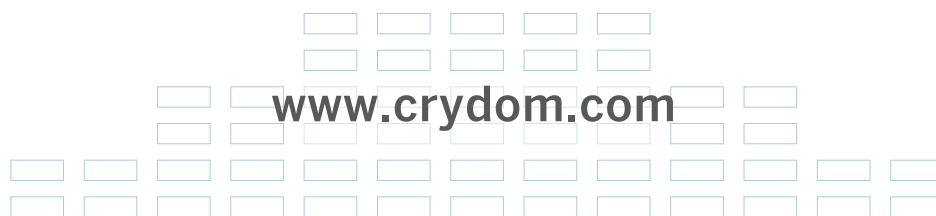



SeriesOne DR Timer DIN Rail Mounted AC & DC Output Solid State Relay Timers

- Single channel 6 Amps output power rating
- Compact Size (11 mm wide)
- 60 VDC & 280 VAC operating voltage ratings
- 12-24, 90-140 & 180-240 VAC/DC control input options available
- 8 Industry standard functions (A/At, B, C, D/Di, H/Ht, L/Li, Ac, Bw)
- IP20 Housing with unique integrated heat sink
- LED Input/Timer status indicator
- AC Output versions with Zero Voltage Turn-On for resistive loads and Random Turn-On for inductive loads
- UL Listed & cUL recognized
- UL & IEC General Use & Motor Control rated



Output Specifications (A)

	DRTx24x06x	DRTx06D06
Operating Voltage Range [Vrms]	24-280 VAC (47-440 Hz)	1-60 VDC
Maximum Load Current [Arms]	6	6
Minimum Load Current [Arms]	0.15	2.5 mA
1 Cycle Surge Current (50/60 Hz) @ 25°C [Apk]	285/300 (B)	NA
Maximum Surge Current (10ms) @ 25°C [A _{dc}]	NA	60 (C)
Maximum On-State Voltage Drop @ Rated Current [V _{pk}]	≤ 1.3 V	≤ 0.6 VDC
Maximum On-State Resistance (RDS-ON) @ 25°C [Ohms]	NA	0.034
Maximum Off-State Leakage Current @ Rated Voltage [mA]	0.1	0.25 (D)
Thermal Resistance Junction to Case [R _{jc}] [°C/W]	NA	1.045
Transient Overvoltage @ 25°C [V _{pk}]	600	NA
Maximum Operating Voltage	NA	1-48 VDC
Minimum Off-State dv/dt @ Maximum Rated Voltage [V/μsec]	500	NA
Maximum I ² t for Fusing (50/60Hz) @ 25°C [A ² sec]	410/375	NA
Minimum Power Factor (with Maximum Load)	0.5	NA
UL 508 Resistive Load [A] (E)	6	6
UL 508 Motor Controller [HP/FLA] (E)	1/3 / 3.6	NA
IEC 62314 LC-A [FLA]	6	NA
IEC 62314 LC-B [Kw]	1.44	NA

Input Specifications (A)

	DRTx24D06x	DRTx24A06x	DRTx24B06	DRTx06D06
Control Voltage Range [VAC/DC]	12-24	180-240	90-140	12-24
Minimum Turn-On Voltage [VAC/DC]	12	180	90	12
Must Turn-Off Voltage [VAC/DC]	1	20	10	1
Minimum Input Current (for On-State) [mA ± 10%] (F)	7.6/6.3 @ 12 VAC/DC	7.2/7.1 @ 180 VAC/DC	7.6/7.4 @ 90 VAC/DC	15.7/12.4 @ 12 VAC/DC
Maximum Input Current [mA ± 10%] (F)	12.1/9.1 @ 24 VAC/DC	9.7/9.6 @ 240 VAC/DC	12.5/12.3 @ 140 VAC/DC	27.9/20.3 @ 24 VAC/DC
Maximum Turn-On Time			Per function (G, H)	
Maximum Turn-Off Time			Per function (G, H)	

General Specifications (A)

	DRTx24x06x	DRTx06D06
Dielectric Strength, Input-Output to Baseplate (50/60Hz) [Vrms]	3750	2500
Minimum Insulation Resistance (@ 500 VDC)		10 ⁹
Maximum Capacitance, Input/Output [pF]		10
Ambient Operating Temperature Range [°C]		-30 to 80
Ambient Storage Temperature Range [°C]		-40 to 125
Status Indicator Display		Green (J)
Air Gap (Spacing) ratings (Amps)		6 A / 11 mm or 4.5 A / No Spacing
Weight (typical) in either [oz] (gr)		1.76 (50)
Housing Material		Self-extinguishing
Terminal Finish		Sulfamate Nickel
Humidity		5 to 85%

General Notes

- (A) All parameters at 40°C unless otherwise specified
 (B) T_j initial: 25°C, t_p: 8.3 ms
 (C) Output Voltage = 2.5 VDC
 (D) Output Voltage = 150 V, Control Voltage = 0 V, T_J = 125°C
 (E) For UL listing the housing can not exceed 130°C or the load terminals exceed 105°C
 (F) Input current variable ± 10% per function
 (G) Timing accuracy ± 10%
 (H) See TABLE 1 and TABLE 2
 (J) See TABLE 3



To view available Installation Sheet scan the QR code with your smartphone or visit www.crydom.com

Part Number Nomenclature

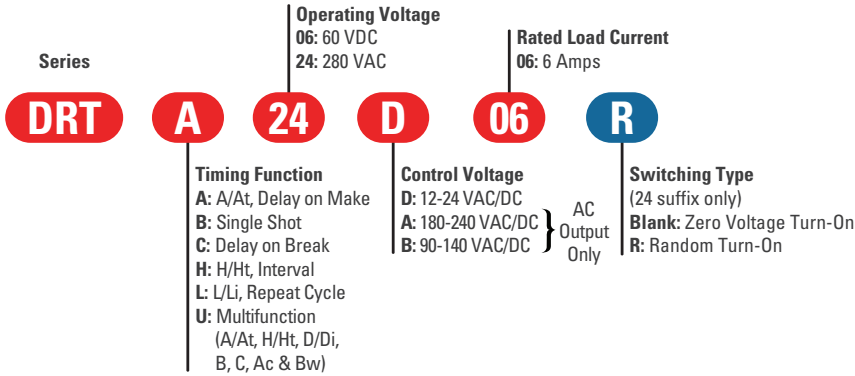

- Required for valid part number
- For options only and not required for valid part number

Block Diagram

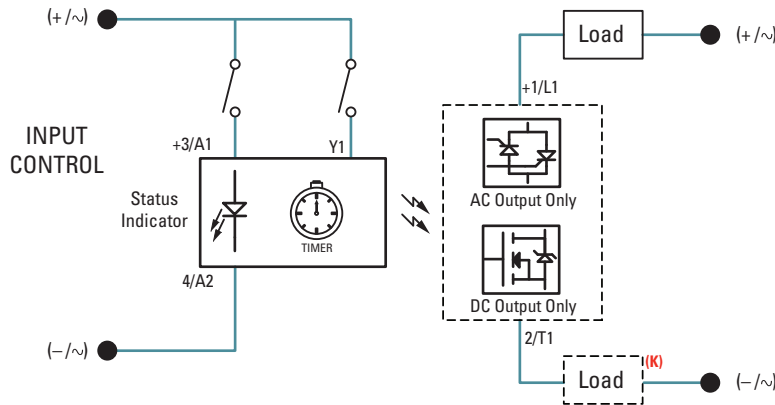

Wiring Diagram

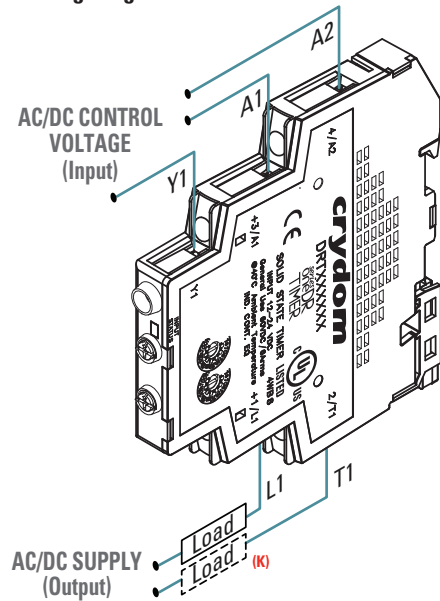

Mechanical Dimensions

Tolerances: ±0.02 in / 0.5 mm
All dimensions are in: inches [millimeters]

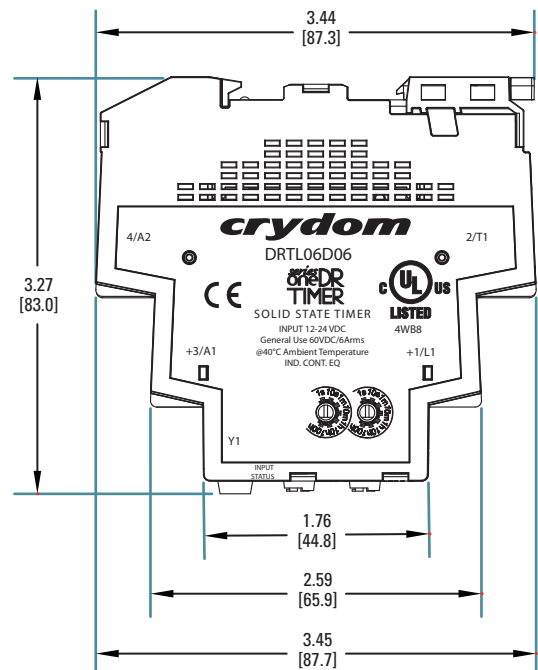
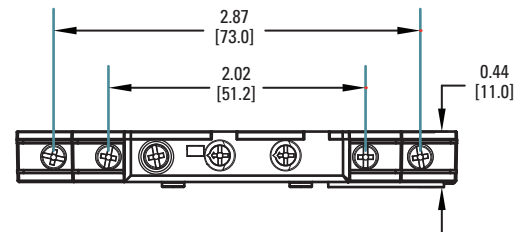

TABLE 1. Timer Settings

Timing Function	Identification	
	Side View	Front View
U Multifunction [A/At, H/Ht, D/Di, B, C, Ac, Bw]	 Range Function	 Fine Adjustment
L Repeat Cycle	 T on T off	 Fine Adjustment
A Delay on Make		
H Interval	 Range	 Fine Adjustment
B Single Shot		
C Delay on Break		

(K) Load is allowed in either terminal L1 or terminal T1.

TABLE 2. Timing Ranges (G)

Identification	Timing Range
1s	0.1 s to 1 s
10 s	1 s to 10 s
1 min	0.1 min to 1 min
10 min	1 min to 10 min
1 h	0.1 h to 1 h
10 h	1 h to 10 h
100 h	10 h to 100 h

Derating Curves

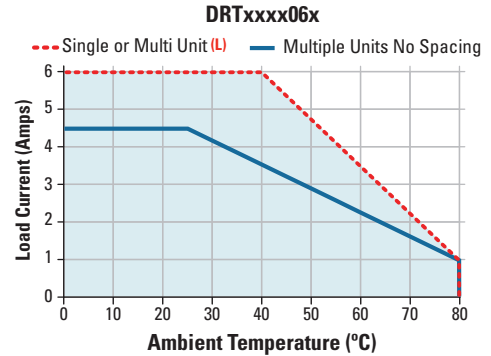

TABLE 3. LED Status by Function

Function	Control Voltage	Y1	Timing	Output State	LED Status	Notes
A/At Delay On Make	Off	◆	Off	Off	Off	At function is identical to the A function except when Y1 is connected to A3 timing is paused. When Y1 is removed timing resumes until relay times out. To reset timer remove control power.
	On	◆	On	Off	Long Flashes	
	On	◆	Timed Out	On	On	
H/Ht Interval	Off	◆	Off	Off	Off	Ht function is identical to the H function except when Y1 is connected to A3 timing is paused. When Y1 is removed timing resumes until relay times out. To reset timer remove control power.
	On	◆	On	On	Long Flashes	
	On	◆	Timed Out	Off	Short Flashes	
D/Di Repeat Cycle	Off	◆	Off	Off	Off	To select between on time (Di) first or off time (D) first Y1 is connected. Default is On time (Di) first, for Off time (D) first connect Y1 . Equal On/Off time.
	On	◆	On	On/Off	Long Flashes/Short Flashes	
L/Li Repeat Cycle	Off	◆	Off	Off	Off	To select between on time (Li) first or off time (L) first Y1 is connected A3 . Default is On time (Li) first, for Off time (L) first connect Y1 to A3 . Time delay is independent of each other.
	On	◆	On	On/Off	Long Flashes/Short Flashes	
B Single Shot	Off	Open	Off	Off	Off	Y1 switch can be momentary or maintained to A3 . To reset timer after relay has timed out Y1 has to be opened.
	On	Open	Off	Off	Short Flashes	
	On	Closed	On	On	Long Flashes	
	On	Closed	Timed Out	Off	Short Flashes	
C Delay On Break	Off	Open	Off	Off	Off	Y1 switch to A3 must be momentary for timing to begin. If during timing Y1 is closed again the time delay is reset and will begin again once Y1 is removed. Once timed out timer is reset and ready for the next cycle.
	On	Open	Off	Off	Short Flashes	
	On	Closed	Off	On	On	
	On	Open	On	On	Long Flashes	
	On	Open	Timed Out	Off	Short Flashes	
Ac Delay On Make / Delay On Break	Off	Open	Off	Off	Off	To start Delay on Make (A) timing connect Y1 to A3 and maintain until LED is on Solid then to start Delay on Break (c) portion remove Y1 until relay times out. Removing Y1 During (A) portion or Connecting Y1 during (c) portion will reset time for that portion.
	On	Open	Off	Off	Short Flashes	
	On	Closed	On	Off	Long Flashes	
	On	Closed	Timed Out	On	On	
	On	Open	On	On	Long Flashes	
	On	Open	Timed Out	Off	Short Flashes	
Bw	Off	Open	Off	Off	Off	Y1 to A3 switch can be momentary or maintained. If maintained until relay has timed out removing it will start timing again. If momentary and timers has timed out reapplying Y1 will start timing again.
	On	Open	Off	Off	Short Flashes	
	On	Closed	On	On	Long Flashes	
	On	Closed	Timed Out	Off	Short Flashes	

(L) Minimum spacing between units is 11 mm

crydom®

AMERICA



United States & Canada

Crydom Inc
2320 Paseo de las Americas,
Suite 201
San Diego, CA 92154
Sales Support:
Tel.: +1 (877) 502 5500
Fax: +1 (619) 210 1590
sales@crydom.com
Technical Support:
Tel.: +1 (877) 702 7700
support@crydom.com

Mexico

**Automatismo Crouzet
S.A. de C.V.**
Calzada Zavaleta 2505-C Col
Sta Cruz Buenavista C.P.
72150 - Puebla
Sales Support:
Tel.: +52 (222) 409 7000
Fax: +52 (222) 409 7810
sales-mx@crydom.com

Southern & Central American Countries

CST Latinoamerica
Alameda Rio Negro, 1030,
18º andar – Conjunto 1803
CEP: 06454-000
Barueri - São Paulo
Brasil
Tel.: +55 (11) 2505 7500
Fax: +55 (11) 2505 7507

EUROPE, MIDDLE EAST & AFRICA



United Kingdom

Crydom SSR Ltd
Arena Business Centre
Holyrood, Close
Poole, Dorset BH17 7FJ
Sales Support
Tel.: +44 (0) 1202 606030
Fax: +44 (0) 1202 606035
sales-europe@crydom.com
Technical Support
support-europe@crydom.com

Austria & Switzerland

Tel.: +44 (0) 1202 606030
Fax: +44 (0) 1202 606035
vertrieb@crydom.com

Belgium

Tel.: +32 (0) 2 460 4413
Fax: +32 (0) 2 461 2614
sales-europe@crydom.com

France

Tel.: +33 (0) 810 123 963
Fax: +33 (0) 810 057 605
sales-europe@crydom.com

Germany

Tel.: +49 (0) 180 3000 506
Fax: +49 (0) 180 3205 227
vertrieb@crydom.com

Italy

Tel.: +39 (0) 2 665 99 260
Fax: +39 (0) 2 665 99 268
sales-europe@crydom.com

Spain

Tel.: +34 902 876 217
Fax: +34 902 876 219
sales-europe@crydom.com

Netherlands

Tel.: +31 (0) 71 582 0068
Fax: +31 (0) 71 542 1648
sales-europe@crydom.com

Middle East, Africa & Other European Countries

Tel.: +44 (0) 1202 606030
Fax: +44 (0) 1202 606035
sales-europe@crydom.com

ASIA PACIFIC



China & Hong Kong

**Custom Sensors &
Technologies Asia
(Shanghai) Ltd.**
13th floor
Chang Feng International
Tower
89 Yunling Road (East)
Putuo District
Shanghai, 200062
Sales Support
Tel.: +86 (0) 21 6065 7725
Fax: +86 (0) 21 6065 7749
sales-cn@crydom.com
Technical Support
support-cn@crydom.com

South Korea

**Custom Sensors &
Technologies**
14F, Kbiz DMC Tower,
189, Seongam-ro, Mapo-gu,
Seoul 121-904, South Korea
Tel.: +82 2 2629 8312
Fax: +82 2 2629 8310
korea@cstsensors.com

India

CST Sensors India Pvt Ltd
4th Floor, Trident Towers,
No. 23, 100 Ft- Ashoka Pillar Road,
2nd Block, Jayanagar,
Bangalore- 560011
Tel: +91 (80) 4113 2204 /05
Fax: +91 (80) 4113 2206
india@cstsensors.com

South East Asian & Pacific Countries Custom Sensors & Technologies

2F, No. 39, Ji-Hu Road
Nei-Hu Dist.
Taipei 114, Taiwan
Tel.: +886 2 8751 6388 ext.131
Fax: +886 2 2657 8725
eap@cstsensors.com
taiwan@cstsensors.com



CAT/CR/DRT/EN

Distributed by :

© 2012 Crydom Inc., All Rights Reserved.

Specifications are subject to change without prior notice. Crydom and the Crydom logo are registered trademarks of Crydom Inc.

09/2012
Rev.111512