



***crydom***<sup>®</sup>

The Global Expert in **Solid State Switching** Technology

A brand of  
**CST**  
CUSTOM SENSORS & TECHNOLOGIES



## ABOUT US

Crydom, a brand of Custom Sensors & Technologies (CST) and **global expert in Solid State Relay Technology**, has a distinguished record of providing high quality, world class Solid State Relay and Control Products for a variety of heating, lighting and motion control applications. Crydom products, coupled with **unparalleled technical support, timely delivery and competitive pricing**, provide Crydom's clients with the innovative products and support necessary to succeed in today's competitive and fast paced global markets.

Crydom's extensive selection of standard off-the-shelf products is constantly being updated and expanded through its continuous improvement and aggressive new product development programs. Utilizing state of the art designs, materials and technology, Crydom offers a wide range of AC and DC output SSRs and solid state contactors in industry standard Panel Mount, PCB Mount, DIN Rail and Plug-In packages, all **meeting global safety and standards agency requirements** such as CE, RoHS, UL, IEC, etc.

Bolstered by four decades of Solid State Relay operations experience, Crydom also specializes and encourages **adapted and fully custom-designed SSR products** for nearly any application where unique specifications and optimized performance are critical for success.

Crydom's modern purpose-built **100,000 square foot manufacturing facility** houses all aspects of its ISO certified operation including Design and Development Engineering, Manufacturing Operations and Quality Assurance, Customer Service, Finance, Marketing and General Management, permitting close coordination of all aspects of Crydom's activities. Applications Engineering and Sales support are both performed in the field to provide Crydom's Customers with the unparalleled technical and commercial support.

Following rigid design guidelines and standards, Crydom products have set the bench mark for SSR performance and reliability world wide. In addition to **award winning designs**, Crydom has acquired an impressive list of **patents** related to SSRs and Solid State Controls, while continuing to develop new circuit and technology-related inventions as part of **extensive R&D programs**.

To learn more about Crydom SSR technology and products, or how an alliance with Crydom can contribute to the success of your project, visit **www.crydom.com** or contact your authorized Crydom Distributor or Crydom Customer Service Representative today.

## DIN RAIL MOUNTED AC & DC OUTPUT SOLID STATE RELAY TIMERS

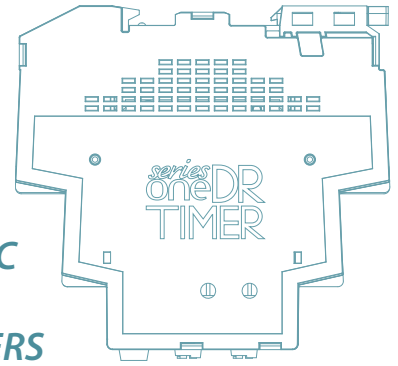

### SeriesOne DR Single Channel AC & DC Output Multifunction Timers

Crydom's proprietary thermal management technology and proven Solid State Relay expertise are now combined with advanced uP based timing in the new **SeriesOne DR Timer** line. Offering models with exceptional Solid State output ratings of either 6 amp AC or DC and 8 different precision timing functions with 18 variations the new **SeriesOne DR Timer** line is housed in a compact 11 mm wide DIN Rail mounted package designed for the direct control of a wide variety of resistive and inductive loads.

### Multifunction Solid State Relay Timing with Superior Output Ratings

Ideal for use in control panels for direct control of contactors, solenoids, motors, heaters, lights, etc., the **SeriesOne DR Timer** series is available with either 6 amp/24 to 280 VAC output rating or 6 amp/1 to 60 VDC output rating, both at 40°C ambient temperature.... ratings well in excess of most Solid State Relay Output Timers in the market today, therefore allowing direct control of many loads thus eliminating the need for interfacing power relays often required for use with lower power timers.

Available timing functions include "A" & "At" delay on make, "B" single shot, "C" delay on break, "H" & "Ht" interval, "L" & "Li" repeat cycle, and "U" multifunction that includes A, At, Ac, B, Bw, C, D, Di, H, and Ht functions. Basic timing function selection is user settable via screw slot rotary switches on the side of the **SeriesOne DR Timers**, while unit and fine timing adjustments are made on the front panel of the Timers. This arrangement provides easy access to Technicians for simple timing adjustments but significantly reduces accidental changes to the basic function.

### Versatile Control

Control for the **SeriesOne DR Timers**, depending on model, is 12 to 24 VAC/DC for all models, with options of either 90 to 140 VAC or 180 to 240 VAC for AC outputs only. All Crydom **SeriesOne DR Timers** are UL listed and cUL recognized, UL Motor Control rated, RoHS and China RoHS compliant, and CE certified to the Low Voltage and EMC Directives.

For more information, technical support or questions about adapted assemblies, contact your local Crydom Distributor, Regional Sales Office or [www.crydom.com](http://www.crydom.com).

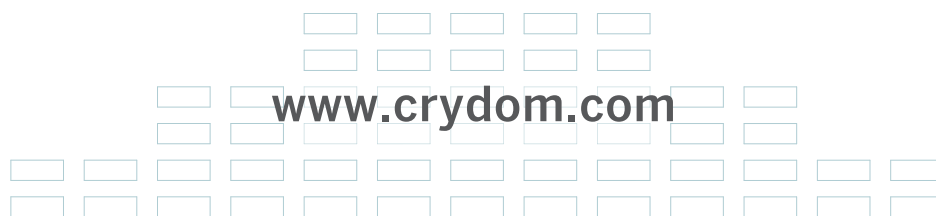



## SeriesOne DR Timer DIN Rail Mounted AC & DC Output Solid State Relay Timers

- Single channel 6 Amps output power rating
- Compact Size (11 mm wide)
- 60 VDC & 280 VAC operating voltage ratings
- 12-24, 90-140 & 180-240 VAC/DC control input options available
- 8 Industry standard functions (A/At, B, C, D/Di, H/Ht, L/Li, Ac, Bw)
- IP20 Housing with unique integrated heat sink
- LED Input/Timer status indicator
- AC Output versions with Zero Voltage Turn-On for resistive loads and Random Turn-On for inductive loads
- UL Listed & cUL recognized
- UL & IEC General Use & Motor Control rated



Output Specifications (A)	DRTx24x06x	DRTx06D06
Operating Voltage Range [Vrms]	24-280 VAC (47-440 Hz)	1-60 VDC
Maximum Load Current [Arms]	6	6
Minimum Load Current [Arms]	0.15	2.5 mA
1 Cycle Surge Current (50/60 Hz) @ 25°C [Apk]	285/300 (B)	NA
Maximum Surge Current (10ms) @ 25°C [A <sub>dc</sub> ]	NA	60 (C)
Maximum On-State Voltage Drop @ Rated Current [V <sub>pk</sub> ]	≤ 1.3 V	≤ 0.6 VDC
Maximum On-State Resistance (RDS-ON) @ 25°C [Ohms]	NA	0.034
Maximum Off-State Leakage Current @ Rated Voltage [mA]	0.1	0.25 (D)
Thermal Resistance Junction to Case [R <sub>jc</sub> ] [°C/W]	NA	1.045
Transient Overvoltage @ 25°C [V <sub>pk</sub> ]	600	NA
Maximum Operating Voltage	NA	1-48 VDC
Minimum Off-State dv/dt @ Maximum Rated Voltage [V/μsec]	500	NA
Maximum I <sup>2</sup> t for Fusing (50/60Hz) @ 25°C [A <sup>2</sup> sec]	410/375	NA
Minimum Power Factor (with Maximum Load)	0.5	NA
UL 508 Resistive Load [A] (E)	6	6
UL 508 Motor Controller [HP/FLA] (E)	1/3 / 3.6	NA
IEC 62314 LC-A [FLA]	6	NA
IEC 62314 LC-B [Kw]	1.44	NA

Input Specifications (A)	DRTx24D06x	DRTx24A06x	DRTx24B06	DRTx06D06
Control Voltage Range [VAC/DC]	12-24	180-240	90-140	12-24
Minimum Turn-On Voltage [VAC/DC]	12	180	90	12
Must Turn-Off Voltage [VAC/DC]	1	20	10	1
Minimum Input Current (for On-State) [mA ± 10%] (F)	7.6/6.3 @ 12 VAC/DC	7.2/7.1 @ 180 VAC/DC	7.6/7.4 @ 90 VAC/DC	15.7/12.4 @ 12 VAC/DC
Maximum Input Current [mA ± 10%] (F)	12.1/9.1 @ 24 VAC/DC	9.7/9.6 @ 240 VAC/DC	12.5/12.3 @ 140 VAC/DC	27.9/20.3 @ 24 VAC/DC
Maximum Turn-On Time			Per function (G, H)	
Maximum Turn-Off Time			Per function (G, H)	

General Specifications (A)	DRTx24x06x	DRTx06D06
Dielectric Strength, Input-Output to Baseplate (50/60Hz) [Vrms]	3750	2500
Minimum Insulation Resistance (@ 500 VDC)		10 <sup>9</sup>
Maximum Capacitance, Input/Output [pF]		10
Ambient Operating Temperature Range [°C]		-30 to 80
Ambient Storage Temperature Range [°C]		-40 to 125
Status Indicator Display		Green (J)
Air Gap (Spacing) ratings (Amps)		6 A / 11 mm or 4.5 A / No Spacing
Weight (typical) in either [oz] (gr)		1.76 (50)
Housing Material		Self-extinguishing
Terminal Finish		Sulfamate Nickel
Humidity		5 to 85%

### General Notes

- (A) All parameters at 40°C unless otherwise specified
- (B) T<sub>j</sub> initial: 25°C, t<sub>p</sub>: 8.3 ms
- (C) Output Voltage = 2.5 VDC
- (D) Output Voltage = 150 V, Control Voltage = 0 V, T<sub>J</sub> = 125°C
- (E) For UL listing the housing can not exceed 130°C or the load terminals exceed 105°C
- (F) Input current variable ± 10% per function
- (G) Timing accuracy ± 10%
- (H) See TABLE 1 and TABLE 2
- (J) See TABLE 3



To view available Installation Sheet scan the QR code with your smartphone or visit [www.crydom.com](http://www.crydom.com)

## Part Number Nomenclature

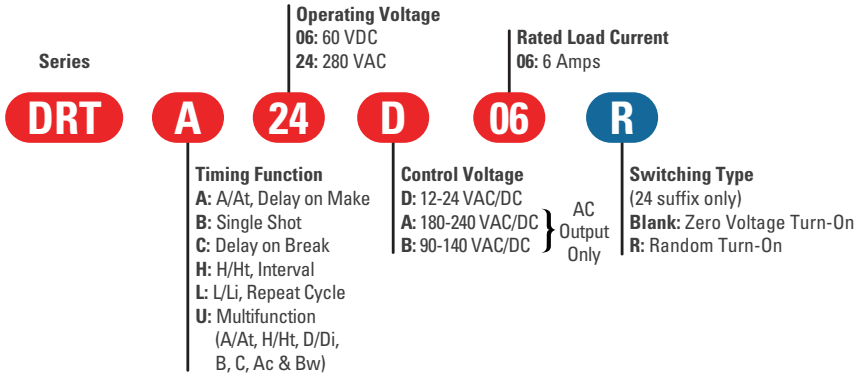

- Required for valid part number
- For options only and not required for valid part number

## Block Diagram

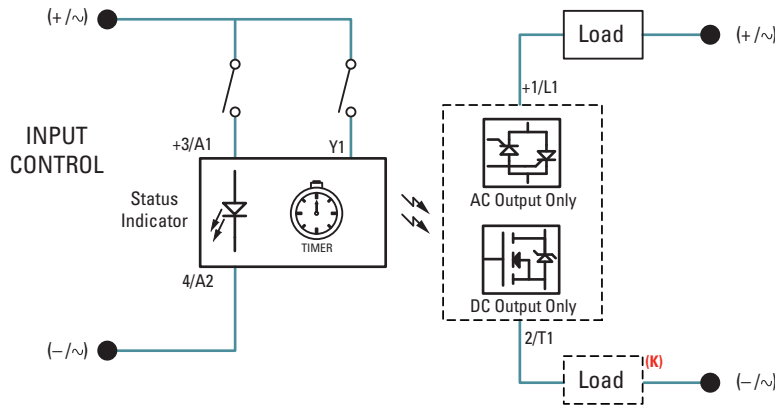

## Wiring Diagram

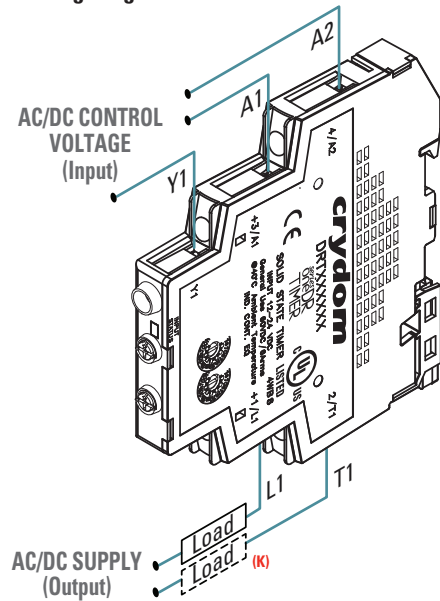

## Mechanical Dimensions

Tolerances: ±0.02 in / 0.5 mm  
 All dimensions are in: inches [millimeters]

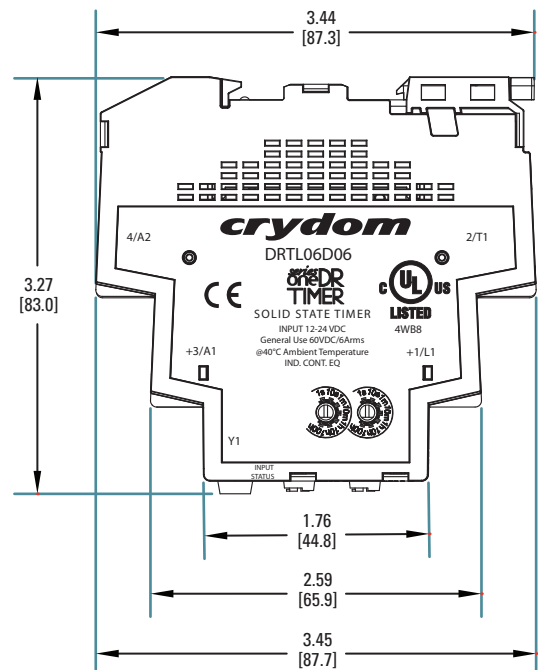
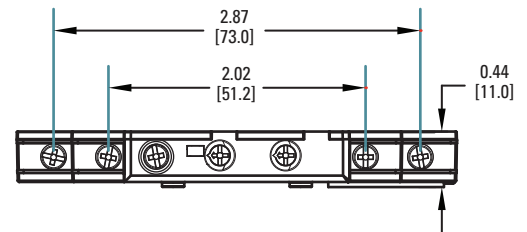

TABLE 1. Timer Settings

Timing Function	Identification	
	Side View	Front View
<b>U</b> Multifunction [A/At, H/Ht, D/Di, B, C, Ac, Bw]	 Range    Function	 Fine Adjustment
<b>L</b> Repeat Cycle	 T on    T off	 Fine Adjustment
<b>A</b> Delay on Make		
<b>H</b> Interval	 Range	 Fine Adjustment
<b>B</b> Single Shot		
<b>C</b> Delay on Break		

(K) Load is allowed in either terminal L1 or terminal T1.

**TABLE 2. Timing Ranges (G)**

Identification	Timing Range
1s	0.1 s to 1 s
10 s	1 s to 10 s
1 min	0.1 min to 1 min
10 min	1 min to 10 min
1 h	0.1 h to 1 h
10 h	1 h to 10 h
100 h	10 h to 100 h

**Derating Curves**

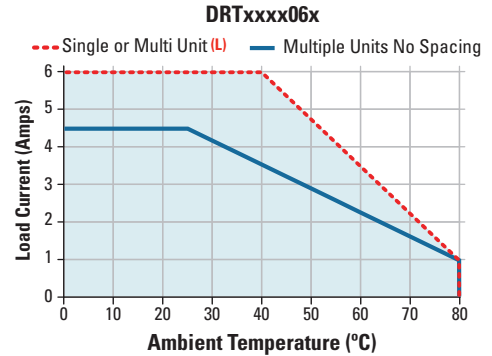

**TABLE 3. LED Status by Function**

Function	Control Voltage	Y1	Timing	Output State	LED Status	Notes
<b>A/At</b> Delay On Make	Off	◆	Off	Off	Off	At function is identical to the <b>A</b> function except when <b>Y1</b> is connected to <b>A3</b> timing is paused. When <b>Y1</b> is removed timing resumes until relay times out. To reset timer remove control power. 
	On	◆	On	Off	Long Flashes	
	On	◆	Timed Out	On	On	
<b>H/Ht</b> Interval	Off	◆	Off	Off	Off	Ht function is identical to the <b>H</b> function except when <b>Y1</b> is connected to <b>A3</b> timing is paused. When <b>Y1</b> is removed timing resumes until relay times out. To reset timer remove control power. 
	On	◆	On	On	Long Flashes	
	On	◆	Timed Out	Off	Short Flashes	
<b>D/Di</b> Repeat Cycle	Off	◆	Off	Off	Off	To select between on time ( <b>Di</b> ) first or off time ( <b>D</b> ) first <b>Y1</b> is connected. Default is On time ( <b>Di</b> ) first, for Off time ( <b>D</b> ) first connect <b>Y1</b> . Equal On/Off time. 
	On	◆	On	On/Off	Long Flashes/Short Flashes	
<b>L/Li</b> Repeat Cycle	Off	◆	Off	Off	Off	To select between on time ( <b>Li</b> ) first or off time ( <b>L</b> ) first <b>Y1</b> is connected <b>A3</b> . Default is On time ( <b>Li</b> ) first, for Off time ( <b>L</b> ) first connect <b>Y1</b> to <b>A3</b> . Time delay is independent of each other. 
	On	◆	On	On/Off	Long Flashes/Short Flashes	
<b>B</b> Single Shot	Off	Open	Off	Off	Off	<b>Y1</b> switch can be momentary or maintained to <b>A3</b> . To reset timer after relay has timed out <b>Y1</b> has to be opened. 
	On	Open	Off	Off	Short Flashes	
	On	Closed	On	On	Long Flashes	
	On	Closed	Timed Out	Off	Short Flashes	
<b>C</b> Delay On Break	Off	Open	Off	Off	Off	<b>Y1</b> switch to <b>A3</b> must be momentary for timing to begin. If during timing <b>Y1</b> is closed again the time delay is reset and will begin again once <b>Y1</b> is removed. Once timed out timer is reset and ready for the next cycle. 
	On	Open	Off	Off	Short Flashes	
	On	Closed	Off	On	On	
	On	Open	On	On	Long Flashes	
	On	Open	Timed Out	Off	Short Flashes	
<b>Ac</b> Delay On Make / Delay On Break	Off	Open	Off	Off	Off	To start Delay on Make ( <b>A</b> ) timing connect <b>Y1</b> to <b>A3</b> and maintain until LED is on Solid then to start Delay on Break ( <b>c</b> ) portion remove <b>Y1</b> until relay times out. Removing <b>Y1</b> During ( <b>A</b> ) portion or Connecting <b>Y1</b> during ( <b>c</b> ) portion will reset time for that portion. 
	On	Open	Off	Off	Short Flashes	
	On	Closed	On	Off	Long Flashes	
	On	Closed	Timed Out	On	On	
	On	Open	On	On	Long Flashes	
	On	Open	Timed Out	Off	Short Flashes	
<b>Bw</b>	Off	Open	Off	Off	Off	<b>Y1</b> to <b>A3</b> switch can be momentary or maintained. If maintained until relay has timed out removing it will start timing again. If momentary and timers has timed out reapplying <b>Y1</b> will start timing again. 
	On	Open	Off	Off	Short Flashes	
	On	Closed	On	On	Long Flashes	
	On	Closed	Timed Out	Off	Short Flashes	

(L) Minimum spacing between units is 11 mm



# crydom®

## AMERICA



### United States & Canada

**Crydom Inc**  
2320 Paseo de las Americas,  
Suite 201  
San Diego, CA 92154  
**Sales Support:**  
Tel.: +1 (877) 502 5500  
Fax: +1 (619) 210 1590  
[sales@crydom.com](mailto:sales@crydom.com)  
**Technical Support:**  
Tel.: +1 (877) 702 7700  
[support@crydom.com](mailto:support@crydom.com)

### Mexico

**Automatismo Crouzet  
S.A. de C.V.**  
Calzada Zavaleta 2505-C Col  
Sta Cruz Buenavista C.P.  
72150 - Puebla  
**Sales Support:**  
Tel.: +52 (222) 409 7000  
Fax: +52 (222) 409 7810  
[sales-mx@crydom.com](mailto:sales-mx@crydom.com)

### Southern & Central American Countries

**CST Latinoamerica**  
Alameda Rio Negro, 1030,  
18º andar – Conjunto 1803  
CEP: 06454-000  
Barueri - São Paulo  
Brasil  
Tel.: +55 (11) 2505 7500  
Fax: +55 (11) 2505 7507

## EUROPE, MIDDLE EAST & AFRICA



### United Kingdom

**Crydom SSR Ltd**  
Arena Business Centre  
Holyrood, Close  
Poole, Dorset BH17 7FJ  
**Sales Support**  
Tel.: +44 (0) 1202 606030  
Fax: +44 (0) 1202 606035  
[sales-europe@crydom.com](mailto:sales-europe@crydom.com)  
**Technical Support**  
[support-europe@crydom.com](mailto:support-europe@crydom.com)

### Austria & Switzerland

Tel.: +44 (0) 1202 606030  
Fax: +44 (0) 1202 606035  
[vertrieb@crydom.com](mailto:vertrieb@crydom.com)

### Belgium

Tel.: +32 (0) 2 460 4413  
Fax: +32 (0) 2 461 2614  
[sales-europe@crydom.com](mailto:sales-europe@crydom.com)

### France

Tel.: +33 (0) 810 123 963  
Fax: +33 (0) 810 057 605  
[sales-europe@crydom.com](mailto:sales-europe@crydom.com)

### Germany

Tel.: +49 (0) 180 3000 506  
Fax: +49 (0) 180 3205 227  
[vertrieb@crydom.com](mailto:vertrieb@crydom.com)

### Italy

Tel.: +39 (0) 2 665 99 260  
Fax: +39 (0) 2 665 99 268  
[sales-europe@crydom.com](mailto:sales-europe@crydom.com)

### Spain

Tel.: +34 902 876 217  
Fax: +34 902 876 219  
[sales-europe@crydom.com](mailto:sales-europe@crydom.com)

### Netherlands

Tel.: +31 (0) 71 582 0068  
Fax: +31 (0) 71 542 1648  
[sales-europe@crydom.com](mailto:sales-europe@crydom.com)

### Middle East, Africa & Other European Countries

Tel.: +44 (0) 1202 606030  
Fax: +44 (0) 1202 606035  
[sales-europe@crydom.com](mailto:sales-europe@crydom.com)

## ASIA PACIFIC



### China & Hong Kong

**Custom Sensors &  
Technologies Asia  
(Shanghai) Ltd.**  
13th floor  
Chang Feng International  
Tower  
89 Yunling Road (East)  
Putuo District  
Shanghai, 200062  
**Sales Support**  
Tel.: +86 (0) 21 6065 7725  
Fax: +86 (0) 21 6065 7749  
[sales-cn@crydom.com](mailto:sales-cn@crydom.com)  
**Technical Support**  
[support-cn@crydom.com](mailto:support-cn@crydom.com)

### South Korea

**Custom Sensors &  
Technologies**  
14F, Kbiz DMC Tower,  
189, Seongam-ro, Mapo-gu,  
Seoul 121-904, South Korea  
Tel.: +82 2 2629 8312  
Fax: +82 2 2629 8310  
[korea@cstsensors.com](mailto:korea@cstsensors.com)

### India

**CST Sensors India Pvt Ltd**  
4th Floor, Trident Towers,  
No. 23, 100 Ft- Ashoka Pillar Road,  
2nd Block, Jayanagar,  
Bangalore- 560011  
Tel: +91 (80) 4113 2204 /05  
Fax: +91 (80) 4113 2206  
[india@cstsensors.com](mailto:india@cstsensors.com)

### South East Asian & Pacific Countries Custom Sensors & Technologies

2F, No. 39, Ji-Hu Road  
Nei-Hu Dist.  
Taipei 114, Taiwan  
Tel.: +886 2 8751 6388 ext.131  
Fax: +886 2 2657 8725  
[eap@cstsensors.com](mailto:eap@cstsensors.com)  
[taiwan@cstsensors.com](mailto:taiwan@cstsensors.com)



CAT/CR/DRT/EN

Distributed by :

© 2012 Crydom Inc., All Rights Reserved.

Specifications are subject to change without prior notice. Crydom and the Crydom logo are registered trademarks of Crydom Inc.

09/2012  
Rev.111512