

**71607-323LF - DUBOX™ : 23  
Position Horizontal Card  
Connector, Surface Mount,  
Single row**

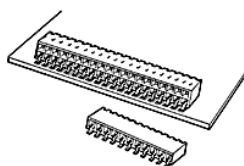

[www.fci.com](http://www.fci.com)

## Mating Half

77315-101-23LF

## Specifications

### General

<b>Hold Down Style</b>	No Locating Pegs
<b>Number of contacts (per row)</b>	23
<b>Number of contacts (Total)</b>	23
<b>Number of rows</b>	1
<b>Orientation</b>	Horizontal
<b>Packaging</b>	Tube
<b>Mating half</b>	Mates with 0.64 mm (0.025 in.) Square pins.
<b>Series Number</b>	71607

### Dimensional

<b>Thickness (Board)</b>	1.6 mm (0.062 in.) or 2.36 mm (0.093 in.)
<b>Footprint (Board)</b>	2.54 mm x 11.43 mm (0.1 in. x 0.45 in.)

### Electrical

<b>Current rating</b>	3A max. per Contact/2A max. per Contact for Full Load
<b>Resistance (Contact)</b>	15 milli ohms Initial, 20 milli ohms After test
<b>Resistance (Insulation)</b>	100000 M-ohms
<b>Voltage rating</b>	1000V rms

### Mechanical

<b>Insertion force</b>	1.50N (150 gf) per Contact
<b>Withdrawal Force</b>	0.3N (30 gf) min. per Contact

### Mounting

<b>Solder process</b>	Wave IR Vapor - Phase
-----------------------	-----------------------------

### Physical

<b>Color (Housing)</b>	Grey
<b>Material (Contact)</b>	Phosphor Bronze
<b>Material (Housing)</b>	High Temperature Thermoplastic

<b>Plating (Contact area)</b>	0.76 µm (30 µin.) Gold
<b>Plating (Tail)</b>	2.54 µm (100 µin.) Tin
<b>Underplating (Contact)</b>	1.27 µm (50 µin.) Nickel
<b>Flammability rating</b>	UL 94 V-0
<b>Temperature (Range)</b>	-65 °C to +125 °C
<b>Approvals / Certifications</b>	
<b>UL File Number</b>	E66906
<b>Approvals / Certifications</b>	UL and CSA Approved

PRODUCT NUMBER  
71607-YXXZLF

WHEN NEEDED, SUFFIX LETTER "LF"  
INDICATES THE PRODUCT IS RoHS  
COMPATIBLE, SEE NOTE 6

OPTIONAL LETTER  
A: PRODUCT PACKED IN TAPE & REEL, SEE TA856.

NUMBER OF POSITIONS: 02 TO 40.

PLATING CODE

- 3= 0.76µm GOLD ON CONTACT AREA.  
3.81µm TIN-LEAD ON TAIL.
- 4= 5µm TIN-LEAD ON CONTACT AREA.  
3.81µm TIN-LEAD ON TAIL.
- 8= 0.38µm GOLD ON CONTACT AREA.  
3.81µm TIN-LEAD ON TAIL.

WHEN SUFFIX "LF" IS REQUIRED, 2µm MIN MATTE  
TIN OVER 1.27 MIN Ni IS SUPPLIED INSTEAD OF SnPb.

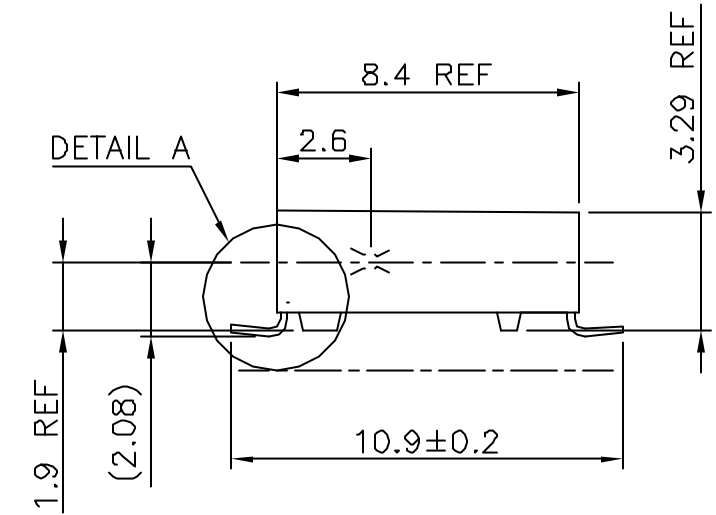
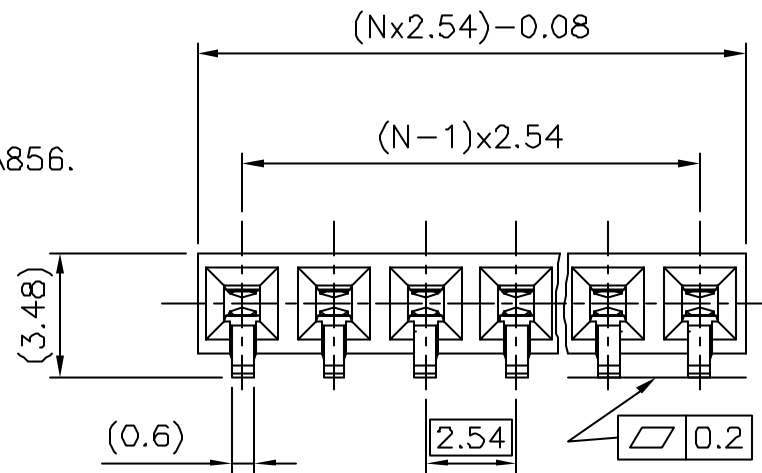

NOTES:

- 1 - HOUSING MAT'L: THERMOPLASTIC GLASS FILLED  
FLAME RETARDANT PER UL 94 V-0 COLOR: GREY.
- 2 - TERMINAL MATERIAL: PHOSPHOR BRONZE.
- 3 - 2 UP TO 4 POSITIONS PRODUCT PACKED IN PLASTIC  
5 UP TO 40 POSITIONS PRODUCT PACKED IN TUBE.
- 4 - TO DETERMINE DIMENSIONS:  
N = NUMBER OF POSITIONS  
EXAMPLE: 8 POS: (Nx2.54)-0.08=20.24 mm
- 5 - RECOMMENDED IR PROFIL PER TA 842.
- 6 - RoHS COMPATIBLE PRODUCT SPECIFICATIONS

a - PLATING:

- "LF" MEANS THE PRODUCT IS LEAD-FREE,  
2µm MINIMUM MATTE TIN OVER 1.27µm  
MINIMUM NICKEL UNDERPLATE.

b - MANUFACTURING PROCESS COMPATIBILITY

- THE HOUSING WILL WITHSTAND EXPOSURE TO  
260°C PEAK TEMPERATURE FOR 30 SECONDS  
MAX IN A CONVECTION, INFRA-RED OR VAPOR  
PHASE OR REFLOW OVEN.

c - LABELING:

- MEETS PACKAGING SPECS AS PER GS-14-920

d - LEGAL STATEMENT: SEE GS-22-008

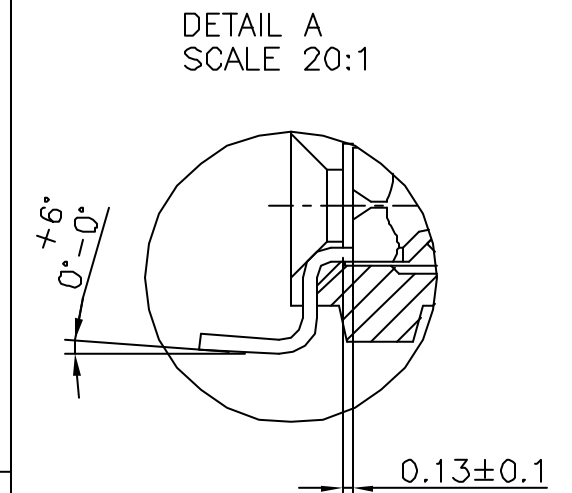
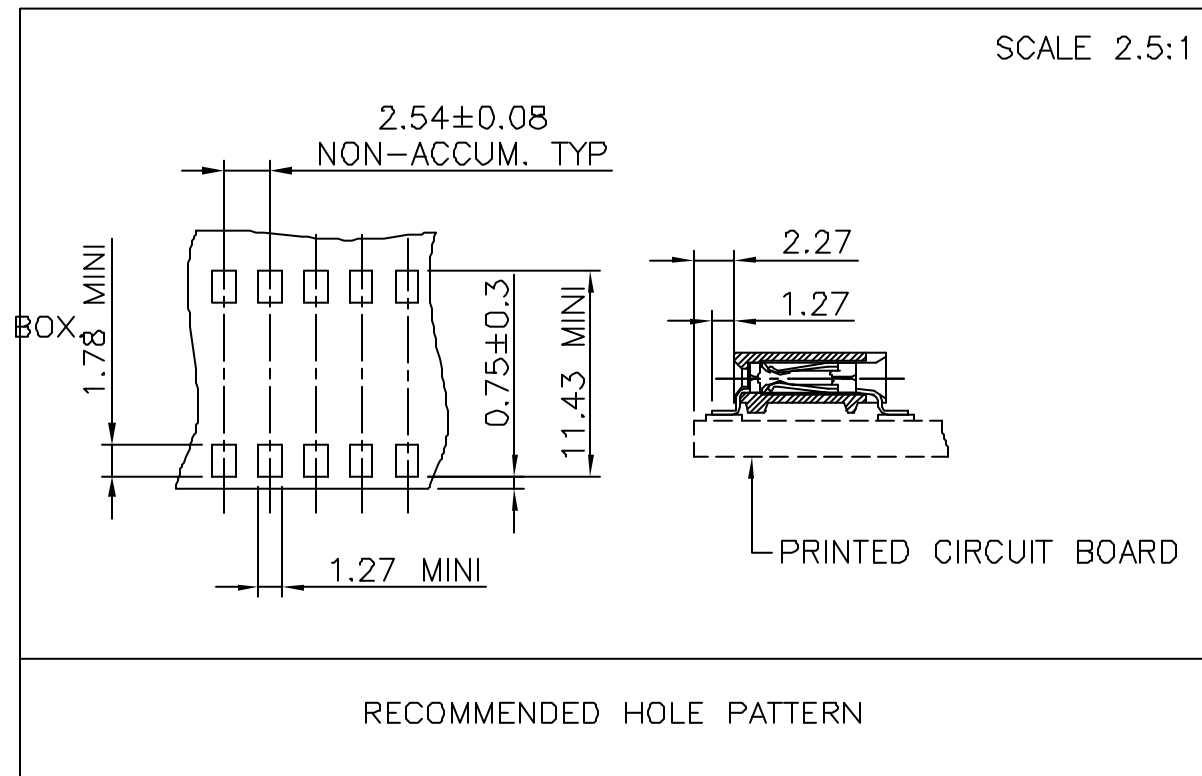

mat'l. code SEE NOTE 1		surface ISO 1302 ✓		tolerance ISO 406 ISO 1101		projection mm		product family DUBOX	
ltr	ecn no	dr	date	tolerances unless otherwise specified		mm		title BtB RECEPT. HORIZ SR SMT	
T	F04-0347	DLE	04.11.08	angles	linear	±0.3		scale 10:1	
U	F06-0204	DLE	06.06.10	±2°		FCI		dwg no 71607	
sheet index		revision sheet		dr	P.NIZZI	94.03.21	sheet 1 of 1		size A3
				enr	P NIZZI	99.06.08	type CUSTOMER		Drawing
				chr	JF NOTTEAU	97.05.13			
				appd	PNZ	99.06.08			