

**71607-307LF - DUBOX™ : 7
Position Horizontal Card
Connector, Surface Mount,
Single row**

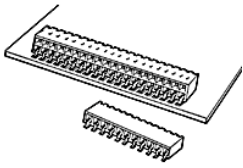

www.fci.com

Mating Half

77315-101-07LF

Specifications

General

Hold Down Style	No Locating Pegs
Number of contacts (per row)	7
Number of contacts (Total)	7
Number of rows	1
Orientation	Horizontal
Packaging	Tube
Mating half	Mates with 0.64 mm (0.025 in.) Square pins.
Series Number	71607

Dimensional

Thickness (Board)	1.6 mm (0.062 in.) or 2.36 mm (0.093 in.)
Footprint (Board)	2.54 mm x 11.43 mm (0.1 in. x 0.45 in.)

Electrical

Current rating	3A max. per Contact/2A max. per Contact for Full Load
Resistance (Contact)	15 milli ohms Initial, 20 milli ohms After test
Resistance (Insulation)	100000 M-ohms
Voltage rating	1000V rms

Mechanical

Insertion force	1.50N (150 gf) per Contact
Withdrawal Force	0.3N (30 gf) min. per Contact

Mounting

Solder process	Wave IR Vapor - Phase
-----------------------	-----------------------------

Physical

Color (Housing)	Grey
Material (Contact)	Phosphor Bronze
Material (Housing)	High Temperature Thermoplastic

Plating (Contact area)	0.76 µm (30 µin.) Gold
Plating (Tail)	2.54 µm (100 µin.) Tin
Underplating (Contact)	1.27 µm (50 µin.) Nickel
Flammability rating	UL 94 V-0
Temperature (Range)	-65 °C to +125 °C
Approvals / Certifications	
UL File Number	E66906
Approvals / Certifications	UL and CSA Approved

PRODUCT NUMBER
71607-YXXZLF

WHEN NEEDED, SUFFIX LETTER "LF"
INDICATES THE PRODUCT IS RoHS
COMPATIBLE, SEE NOTE 6

OPTIONAL LETTER

A: PRODUCT PACKED IN TAPE & REEL, SEE TA856.

NUMBER OF POSITIONS: 02 TO 40.

PLATING CODE

3= 0.76µm GOLD ON CONTACT AREA.
3.81µm TIN-LEAD ON TAIL.

4= 5µm TIN-LEAD ON CONTACT AREA.
3.81µm TIN-LEAD ON TAIL.

8= 0.38µm GOLD ON CONTACT AREA.
3.81µm TIN-LEAD ON TAIL.

WHEN SUFFIX "LF" IS REQUIRED, 2µm MIN MATTE
TIN OVER 1.27 MIN Ni IS SUPPLIED INSTEAD OF SnPb.

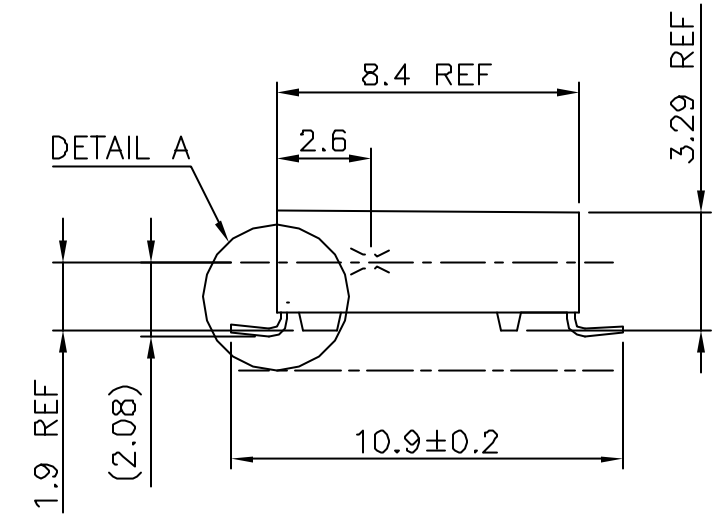
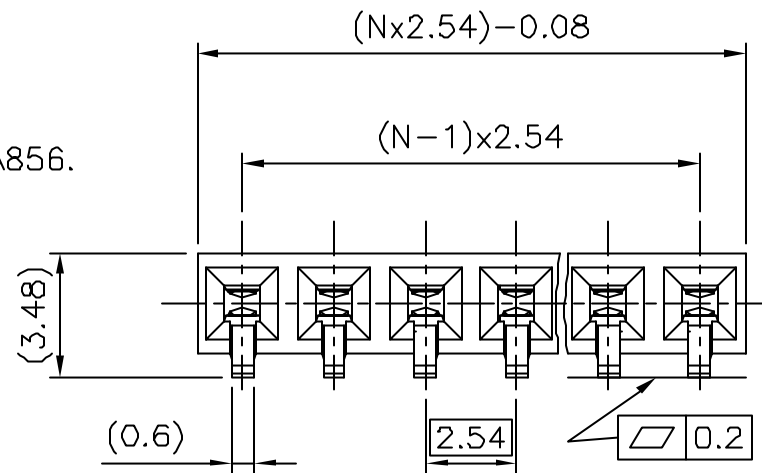

NOTES:

- 1 - HOUSING MAT'L: THERMOPLASTIC GLASS FILLED
FLAME RETARDANT PER UL 94 V-0 COLOR: GREY.
- 2 - TERMINAL MATERIAL: PHOSPHOR BRONZE.
- 3 - 2 UP TO 4 POSITIONS PRODUCT PACKED IN PLASTIC
5 UP TO 40 POSITIONS PRODUCT PACKED IN TUBE.
- 4 - TO DETERMINE DIMENSIONS:
N = NUMBER OF POSITIONS
EXAMPLE: 8 POS: (Nx2.54)-0.08=20.24 mm
- 5 - RECOMMENDED IR PROFIL PER TA 842.
- 6 - RoHS COMPATIBLE PRODUCT SPECIFICATIONS

a - PLATING:

- "LF" MEANS THE PRODUCT IS LEAD-FREE,
2µm MINIMUM MATTE TIN OVER 1.27µm
MINIMUM NICKEL UNDERPLATE.

b - MANUFACTURING PROCESS COMPATIBILITY

- THE HOUSING WILL WITHSTAND EXPOSURE TO
260°C PEAK TEMPERATURE FOR 30 SECONDS
MAX IN A CONVECTION, INFRA-RED OR VAPOR
PHASE OR REFLOW OVEN.

c - LABELING:

- MEETS PACKAGING SPECS AS PER GS-14-920

d - LEGAL STATEMENT: SEE GS-22-008

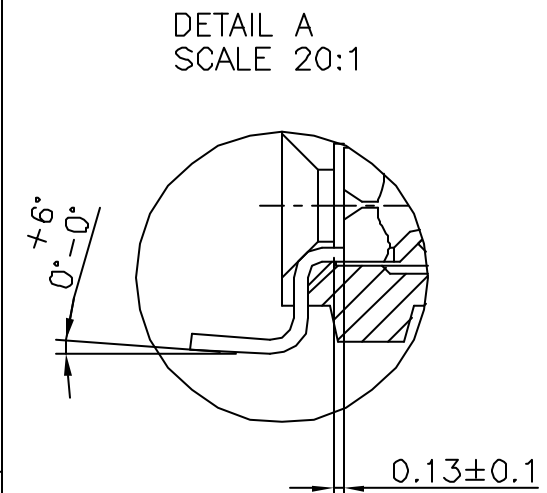
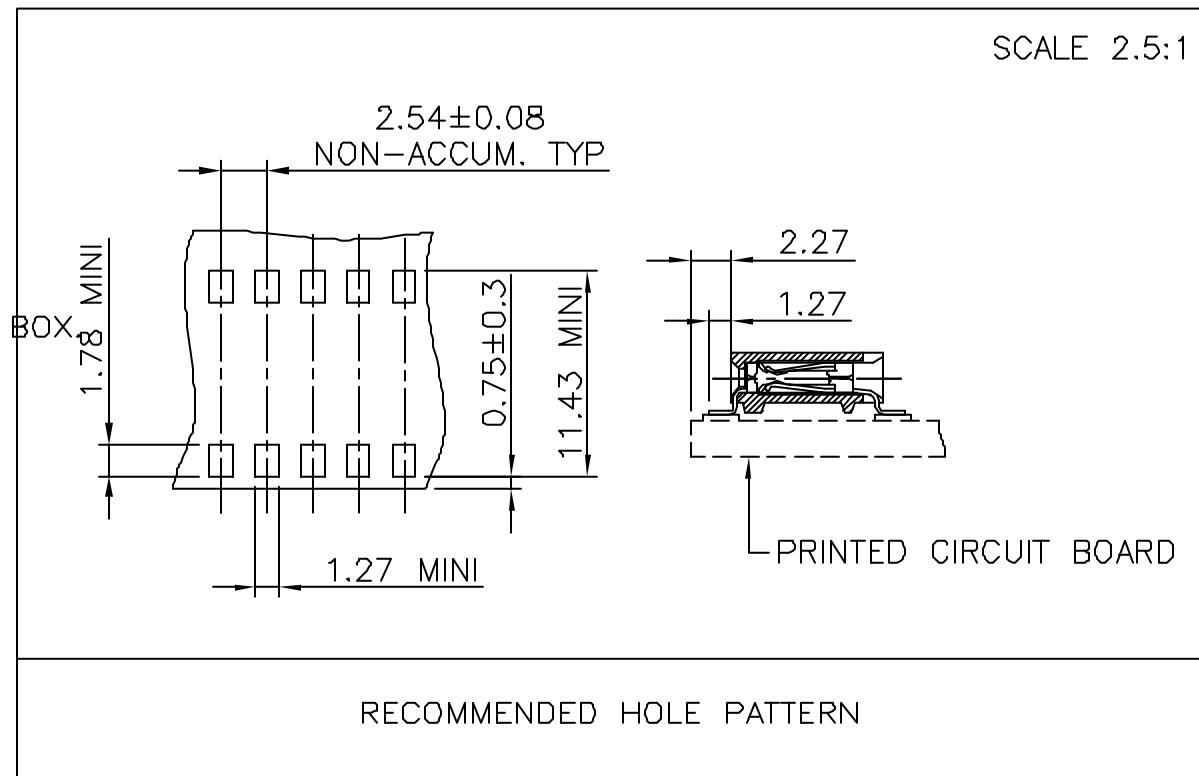

mat'l. code SEE NOTE 1		surface ISO 1302 ✓		tolerance ISO 406 ISO 1101		projection mm		product family DUBOX	
ltr	ecn no	dr	date	tolerances unless otherwise specified		mm		title BtB RECEPT. HORIZ SR SMT	
T	F04-0347	DLE	04.11.08	angles	linear	±0.3		scale 10:1	
U	F06-0204	DLE	06.06.10	±2°		FCI		dwg no 71607	
sheet index		revision sheet		dr	P.NIZZI	94.03.21	sheet 1 of 1		size A3
				enr	P NIZZI	99.06.08	type CUSTOMER		Drawing
				chr	JF NOTTEAU	97.05.13			
				appd	PNZ	99.06.08			