

71600-110LF - Quickie® :
Receptacle -Double row - 10
Positions - 2.54 mm (0.1 in.)

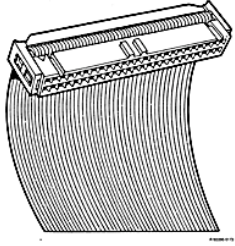

www.fci.com

Mating Half

▶ 71918-210LF

▶ 71922-210LF

Specifications

General

Insulation Displacement Contact (IDC)	IDC Receptacle
Number of contacts (Total)	10
Number of rows	2
Polarization	Center and Dual
Strain Relief	None
Style	Standard Single Beam
Termination Style	IDC
Application Equipment	QP-104 QP-112 QP-106
Mating half	Mates with shrouded Eject Latch Header Latch 2

Electrical

Current rating	1 amp Continuous
Resistance (Contact)	15 m ohms max.
Resistance (Insulation)	50000 M-ohms
Voltage rating	1000V AC rms

Physical

Color (Housing)	Grey
Material (Contact)	Phosphor Bronze
Material (Housing)	Glass - Filled Thermoplastic Polyester
Plating (Contact area)	0.76 µm (30 µin.) Gold
Underplating (Contact)	1.27 µm (50 µin.) Nickel
Flammability rating	UL 94 V-0
Temperature (Range)	-65°C to +105°C

Approvals / Certifications

UL File Number	E66906
-----------------------	--------

CSA File Number	LR46923
Approvals / Certifications	UL and CSA Approved
Other Features	
Packaging (Type)	Tube

PRODUCT NUMBER

71600-YXXLF

LEAD FREE, SEE NOTE 6

TOTAL NB OF POSITION 04 TO 64
SEE SHEET 2

OPTIONAL STRAIN RELIEF
SEE SHEET 2

TRIANGLE INDICATES
POSITION 1
NOTE 5

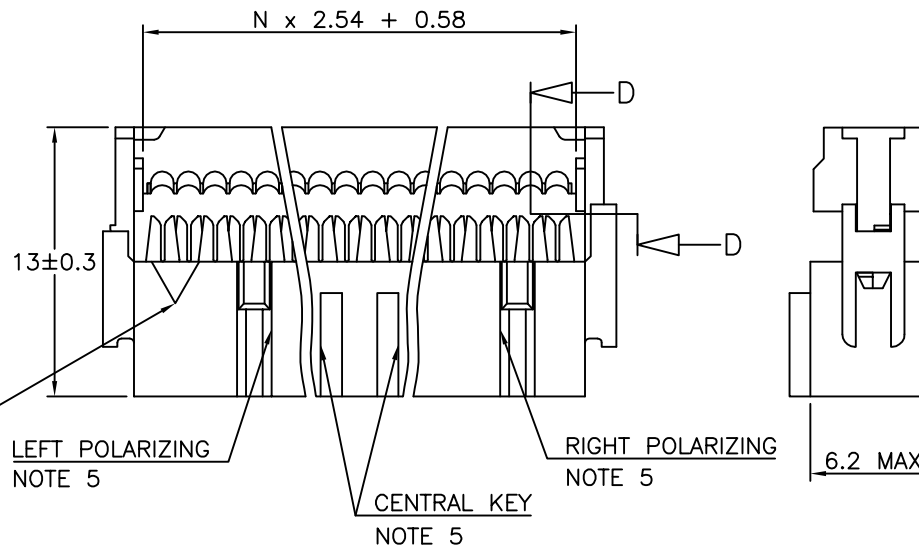

NOTES:

- 1 - PLASTIC MAT'L : GLASS FILLED HIGH TEMPERATURE THERMOPLASTIC. UL94V-0 COLOR: GREY
- 2 - PIN MATERIAL : PHOSPHOR BRONZE
- 3 - PRODUCT PACKAGED IN TUBES.
- 4 - TO DETERMINE DIMENSIONS :
N = NUMBER OF POSITIONS PER ROW
EXAMPLE : 8 POS N x 2.54 = 20.32mm
- 5 - 2x5, 2x6, 2x7 HAVE NO LEFT POLARIZING SLOT.
- 2x2, 2x3 WITH CENTRAL KEY HAVE NO TRIANGLE, NO LEFT AND RIGHT POLARIZING SLOT.
- 2x2 WITHOUT CENTRAL KEY HAS NO LEFT AND RIGHT POLARIZING SLOT.
- 2x3, 2x4 WITHOUT CENTRAL KEY HAVE NO LEFT POLARIZING SLOT
- 2x4 WITH CENTRAL KEY HAVE NO LEFT AND RIGHT POLARIZING SLOT
- 6 - THIS PRODUCT MEETS EUROPEAN UNION DIRECTIVES AND OTHER COUNTRY REGULATIONS AS PER GS-22-008.
PACKAGING SPECIFICATION AS PER GS-14-920.

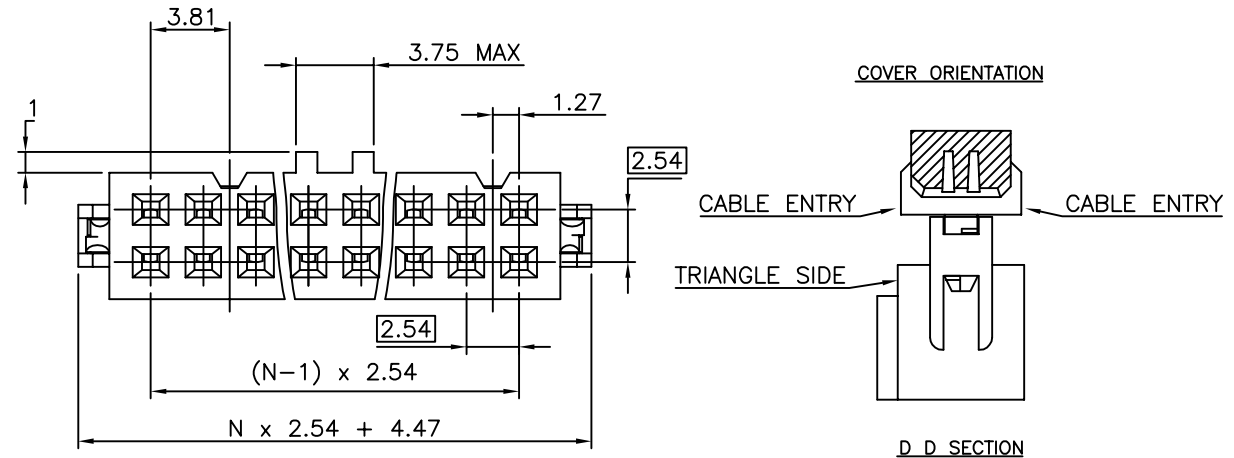

mat'l. code SEE NOTES		surface ISO 1302	tolerance ISO 406 ISO 1101	projection mm	product family 2.54MM IDC
ltr	ecn no	dr	date	tolerances unless otherwise specified	title
AP	F12-0046	LMU	12.04.25	angles linear X.X ±0.3 X.XX ±0.13 X.XXX ±0.05	QUICKIE III FEM 0.76µm Au
AJ	F05-0171	LMU	05.04.07		scale 5:1
AK	F05-0180	LMU	05.04.22	dr	D.LE 01.01.24
AL	F06-0270	LMU	06.09.12	engr	P.NZ 01.01.24
AM	F06-0274	LMU	06.09.25	chr	JF.N 01.01.24
AN	F09-0233	LMU	09.12.15	appd	P.NZ 01.01.24
sheet index	revision sheet	AP	AE		
	1	2			



CORE RANGE	
STRAIN RELIEF	Nbr OF POSITIONS
0/1	04
0/1	06
0/1	08
0/1	10
0/1	14
0/1	16
0/1	18
0/1	20
0/1	24
0/1	26
0/1	30
0/1	34
0/1	40
0/1	50
0/1	60
0/1	64

PLATING
0.76µm GOLD ON CONTACT AREA
1.27 µm Ni REMAINDER OF PRODUCT

CATALOGUE RANGE	
STRAIN RELIEF	Nbr OF POSITIONS
2/6	04
2/6	06
2/6	08
2/6	10
2/6	14
2/6	16
2/6	18
2/6	20
2/6	24
2/6	26
2/6	30
2/6	34
2/6	40
2/6	50
2/6	60
2/6	64

PLATING
0.76µm GOLD ON CONTACT AREA
1.27 µm Ni REMAINDER OF PRODUCT

624
304
204 / 224
004
DASHES NOT AVAILABLE

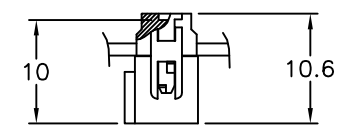

WITHOUT STRAIN RELIEF

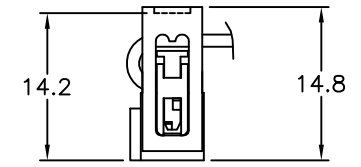

WITH LOW PROFILE STRAIN RELIEF

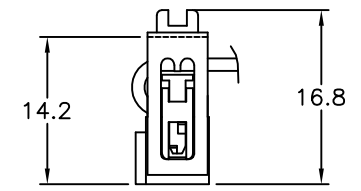

WITH STANDARD STRAIN RELIEF

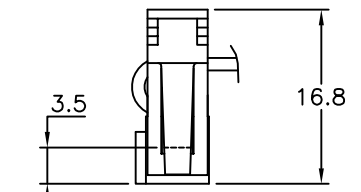

WITH LATCHING STRAIN RELIEF

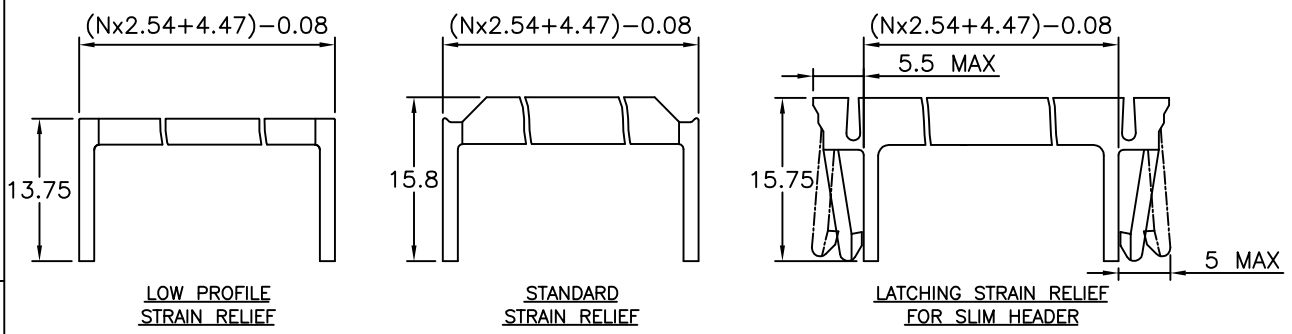

LOW PROFILE STRAIN RELIEF

STANDARD STRAIN RELIEF

LATCHING STRAIN RELIEF FOR SLIM HEADER

71600-6YYLF	●					●
71600-3YYLF		●	●			
71600-2YYLF	●				●	
71600-1YYLF	●			●		
71600-0YYLF	●		●			
PRODUCT NUMBER	WITH	WITHOUT	STANDARD	WITHOUT	LOW PROFILE	LATCHING
	CENTRAL KEY		STRAIN RELIEF			

mat'l. code		surface <input checked="" type="checkbox"/> ISO 1302		tolerance <input checked="" type="checkbox"/> ISO 406 <input type="checkbox"/> ISO 1101		projection		product family QUICKIE	
ltr	ecn no	dr	date	tolerances unless otherwise specified		mm		title IDC RECEPT DR	
X	F70666	AAN	97.11.05	angles	linear	scale N/A		sheet 2 of - size A3	
Y	F10121	DLE	01.01.24					71600	
AA	F10199	GCO	01.04.26					CUSTOMER Drawing	
AB	F03019	DLE	03.01.23	dr	D.LE	01.01.24	FCI		
AC	F05-0180	LMU	05.04.22	engr	P.NZ	01.01.24			
AD	F06-0270	LMU	06.09.12	chr	JF.N	01.01.24			
AE	F06-0274	LMU	06.09.25	appd	P.NZ	01.01.24			
sheet index	revision sheet								

Copyright FCI
 FCIconnect.com