

Plug-in Screw Connector System for Printed Circuit Boards

120-M-121 /-221 | 5.00 mm (0.197 in) Spacing - 2-24 poles

PICTURES



120-M-121



120-M-221



120-M-221 & 120-D-111

TECHNICAL INFORMATION

Description



Header

Coding keys 120-K are available to prevent the insertion of the wrong plug into a header. These are usually field inserted but can be factory installed if required.

Technical Data**Center to Center Spacing:** 5.000 mm (0.197 in)**Recommended Hole Diameter in PC Board:** 1.400 mm (0.055 in)**Bill of Materials****Molding :** Polyamide, Self extinguishing UL 94, V-0**Color :** Grey**Temperature limits :****Short Time :** 140°C (284°F)**Continuous :** 105°C (221°F)**Low Limit :** -40°C (-40°F)**Comparative Tracking Index :** CTI ? 600 V**Oxygen Index Rating :** 33 %**Solder Pin:** Tin plated copper alloy 1 x 1 mm (0.04 x 0.04 in.)

APPROVAL INFORMATION

UL File No. E69841 | CSA File No. LR24322

Type	Current (A)	Voltage (V)	Application Group	AWG	Screw Tightening Torque
 120-M-121 /-221 5.0 mm	15	300	B		
	10	300	D		
 120-M-121 /-221 5.0 mm	15	300	B		
	10	300	D, E		

Alternative Approval Information

Type	Current (A)	Voltage (V)	Application Group	AWG	Screw Tightening Torque
120-M-121 /-221	15	300	C		
10.0 mm	5	600	D		
120-M-121 /-221		600	D, E		
10.0 mm					

International Approval Information



Rated Impulse Withstand Voltage : 2500 V

PLUGGING PARTS

Plug-In Direction Perpendicular to PCB and Wire Entrance Parallel to PCB



TYPE 120-D-111
 5.00 mm spacing - 2-24 poles

TYPE 120-D-121
 5.00 mm spacing - 2-24 poles

Plug-In Direction and Wire Entrance Perpendicular to PCB

TYPE 120-A-111
 5.00 mm spacing - 2-24 poles

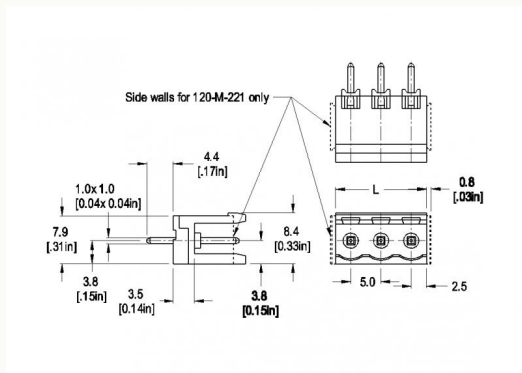
TECHNICAL DRAWING



Description :

Length of Connector (L)

L = No. of Poles x Center to Center Spacing

(A) Side walls for 120-M-221 only

ILLUSTRATIONS

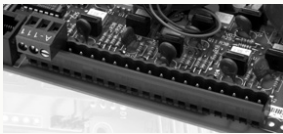
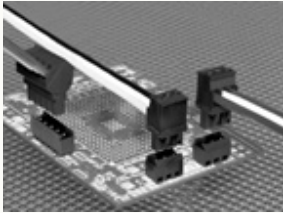
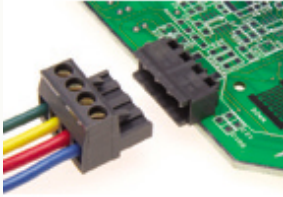

Description :

SECTION A - SERIES 12
Terminal Blocks for Printed Circuit Boards

The Conecta system brings versatility and reliability to making connections between printed circuit boards and electronic or electrical components. The elevator-style clamping mechanism has excellent contact qualities and resistance to vibration to prevent wiring from loosening, ensuring that connections are secure and reliable for the life of the component. The elevator-style clamping mechanism allows for almost unlimited connect/disconnect cycles without harming the wires this is especially important during the prototyping stage of design. The contact springs are designed to ensure low resistance current transmission over the long term. The special design of the contact springs provides for efficient long-lasting current transmission. A variety of headers and plugs provide horizontal, vertical and 45-degree wire insertions in relation to the PCB to meet most design needs.

These terminal blocks meet common industry design parameters and are interchangeable with similar blocks from other manufacturers.

A choice of metric and inch spacing is available. Headers are available with and without sidewalls the sidewall provides a greater degree of security by shrouding the contact pins and preventing misalignment of the header and the plug. WECO is adding a 7.5 mm version, Series 122. This allows easier wire insertion under crowded field wiring conditions.

Many headers and plugs are also available with mounting or locking flanges. Mounting flanges provide additional contact security on the PCB. Plugs' locking flanges are supplied with captive screws the matching headers have threaded inserts. These special plug and header combinations prevent the accidental separation of plug and header during use.

The metric 120-M-311 and 120-M-411 types are designed with a larger base area when more stability and resistance to solder joint damage is required.

Screw-type plugs are captive and will not work loose and be lost during manufacturing or use. All single level headers with standard spacing provide 2 to 24 positions for those applications requiring very high wiring densities, our double level headers provide 4 to 48 poles.

If a printed circuit board design presents a difficult and crowded situation, raised headers in both metric and inch spacing are available these allow the plug to connect to the high profile header outside the enclosure if needed. The design of the plug and header includes a latching mechanism to prevent accidental separation due to the effect of vibration while allowing easy disconnection when required.

Each product has a "How To Order" area as well as a complete listing of UL and CSA approval specifications, available options and accessories.