

80x80x38 mm

59.5~84.1 CFM

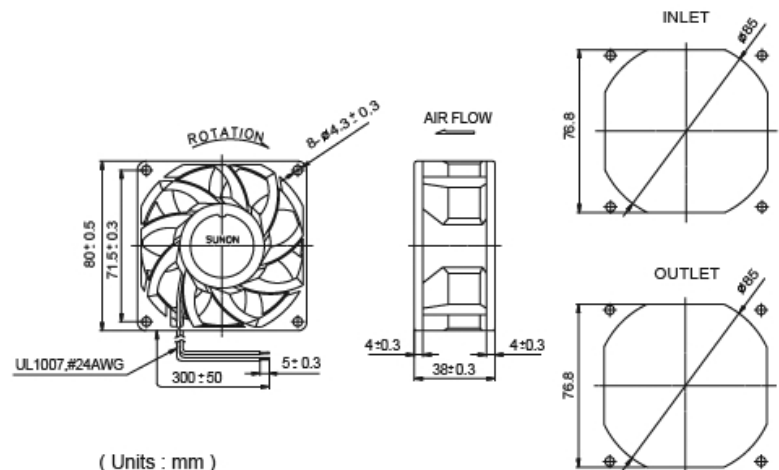

Model	P/N	Bearing ● 2BALL ○ Sleeve	Rating Voltage (VDC)	Power Current (AMP)	Power Consumption (WATTS)	Speed (RPM)	Air Flow (CFM)	Static Pressure (Inch-H ₂ O)	Noise (dBA)	Weight (g)	Curve
PMD1208PMB1-A	(2).GN	●	12	0.76	9.1	5700	84.1	0.74	55.2	175	1
PMD1208PMB2-A	(2).GN	●	12	0.53	6.4	4900	74.5	0.57	51.6	175	2
PMD1208PMB3-A	(2).GN	●	12	0.37	4.4	4200	59.5	0.43	47.3	175	3
PMD2408PMB1-A	(2).GN	●	24	0.40	9.6	5700	84.1	0.74	55.2	175	1
PMD2408PMB2-A	(2).GN	●	24	0.30	7.2	4900	74.5	0.57	51.6	175	2
PMD2408PMB3-A	(2).GN	●	24	0.20	4.8	4200	59.5	0.43	47.3	175	3
PMD4808PMB1-A	(2).GN	●	48	0.19	9.1	5700	84.1	0.74	55.2	175	1
PMD4808PMB2-A	(2).GN	●	48	0.14	6.7	4900	74.5	0.57	51.6	175	2
PMD4808PMB3-A	(2).GN	●	48	0.10	4.8	4200	59.5	0.43	47.3	175	3

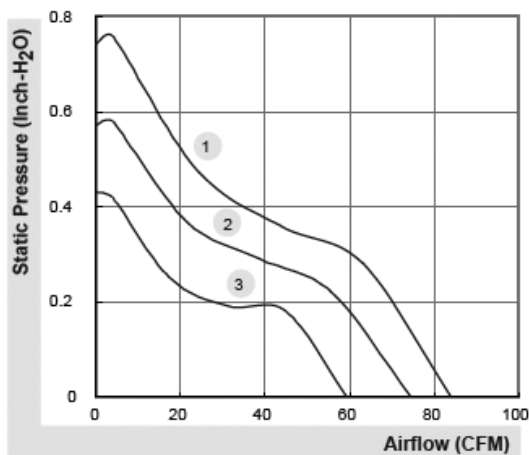

*All model could be customized. Please contact with Sunon Sales.

*Specifications subject to change without notice. Please Visit SUNON web site at <http://www.sunon.com> for update information.