

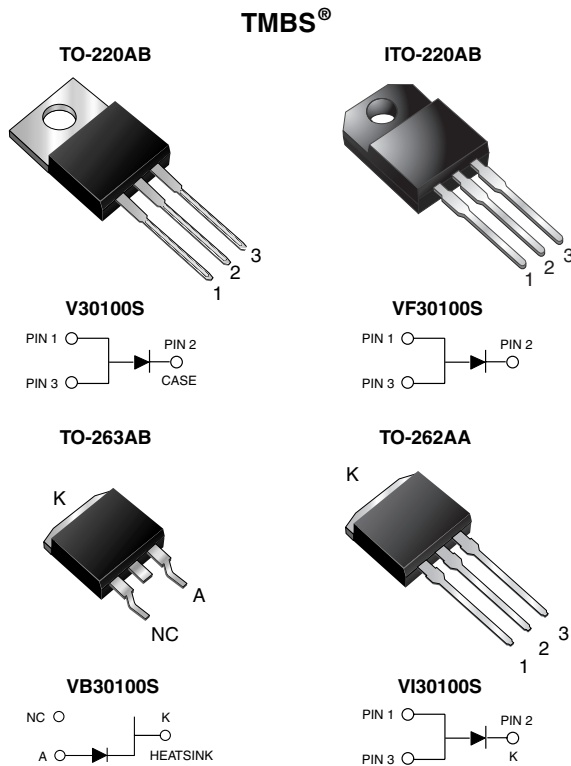

## High-Voltage Trench MOS Barrier Schottky Rectifier

Ultra Low  $V_F = 0.39\text{ V}$  at  $I_F = 5\text{ A}$



### PRIMARY CHARACTERISTICS

$I_{F(AV)}$	30 A
$V_{RRM}$	100 V
$I_{FSM}$	250 A
$V_F$ at $I_F = 30\text{ A}$	0.69 V
$T_J$ max.	150 °C

### FEATURES

- Trench MOS Schottky technology
- Low forward voltage drop, low power losses
- High efficiency operation
- Low thermal resistance
- Meets MSL level 1, per J-STD-020, LF maximum peak of 245 °C (for TO-263AB package)
- Solder dip 260 °C, 40 s (for TO-220AB, ITO-220AB, and TO-262AA package)
- Component in accordance to RoHS 2002/95/EC and WEEE 2002/96/EC



**RoHS**  
COMPLIANT

### TYPICAL APPLICATIONS

For use in high frequency inverters, switching power supplies, freewheeling diodes, OR-ing diode, dc-to-dc converters and reverse battery protection.

### MECHANICAL DATA

**Case:** TO-220AB, ITO-220AB, TO-263AB and TO-262AA

Epoxy meets UL 94V-0 flammability rating

**Terminals:** Matte tin plated leads, solderable per J-STD-002 and JESD22-B102

E3 suffix for consumer grade, meets JESD 201 class 1A whisker test

**Polarity:** As marked

**Mounting Torque:** 10 in-lbs maximum

### MAXIMUM RATINGS ( $T_A = 25\text{ °C}$ unless otherwise noted)

PARAMETER	SYMBOL	V30100S	VF30100S	VB30100S	VI30100S	UNIT
Maximum repetitive peak reverse voltage	$V_{RRM}$	100				V
Maximum average forward rectified current (Fig. 1)	$I_{F(AV)}$	30				A
Peak forward surge current 8.3 ms single half sine-wave superimposed on rated load	$I_{FSM}$	250				A
Isolation voltage (ITO-220AB only) From terminal to heatsink $t = 1\text{ min}$	$V_{AC}$	1500				V
Operating junction and storage temperature range	$T_J, T_{STG}$	- 40 to + 150				°C

<b>ELECTRICAL CHARACTERISTICS</b> ( $T_A = 25\text{ }^\circ\text{C}$ unless otherwise noted)						
PARAMETER	TEST CONDITIONS		SYMBOL	TYP.	MAX.	UNIT
Breakdown voltage	$I_R = 10\text{ mA}$	$T_A = 25\text{ }^\circ\text{C}$	$V_{BR}$	105 (minimum)	-	V
Instantaneous forward voltage <sup>(1)</sup>	$I_F = 5\text{ A}$ $I_F = 10\text{ A}$ $I_F = 30\text{ A}$	$T_A = 25\text{ }^\circ\text{C}$	$V_F$	0.47 0.55 0.80	- - 0.91	V
	$I_F = 5\text{ A}$ $I_F = 10\text{ A}$ $I_F = 30\text{ A}$	$T_A = 125\text{ }^\circ\text{C}$		0.39 0.49 0.69	- - 0.78	
Reverse current <sup>(2)</sup>	$V_R = 70\text{ V}$	$T_A = 25\text{ }^\circ\text{C}$ $T_A = 125\text{ }^\circ\text{C}$	$I_R$	27 11	- -	$\mu\text{A}$ mA
	$V_R = 100\text{ V}$	$T_A = 25\text{ }^\circ\text{C}$ $T_A = 125\text{ }^\circ\text{C}$		70 23	1000 45	$\mu\text{A}$ mA

**Notes:**

(1) Pulse test: 300  $\mu\text{s}$  pulse width, 1 % duty cycle

(2) Pulse test: Pulse width  $\leq 40\text{ ms}$

<b>THERMAL CHARACTERISTICS</b> ( $T_A = 25\text{ }^\circ\text{C}$ unless otherwise noted)						
PARAMETER	SYMBOL	V30100S	VF30100S	VB30100S	VI30100S	UNIT
Typical thermal resistance	$R_{\theta JC}$	2.0	4.0	2.0	2.0	$^\circ\text{C/W}$

<b>ORDERING INFORMATION</b> (Example)					
PACKAGE	PREFERRED P/N	UNIT WEIGHT (g)	PACKAGE CODE	BASE QUANTITY	DELIVERY MODE
TO-220AB	V30100S-E3/45	1.875	45	50/tube	Tube
ITO-220AB	VF30100S-E3/45	1.805	45	50/tube	Tube
TO-263AB	VB30100S-E3/4W	1.380	4W	50/tube	Tube
TO-263AB	VB30100S-E3/8W	1.380	8W	800/reel	Tape and reel
TO-262AA	VI30100S-E3/4W	1.455	4W	50/tube	Tube

**RATINGS AND CHARACTERISTICS CURVES**

( $T_A = 25\text{ }^\circ\text{C}$  unless otherwise noted)

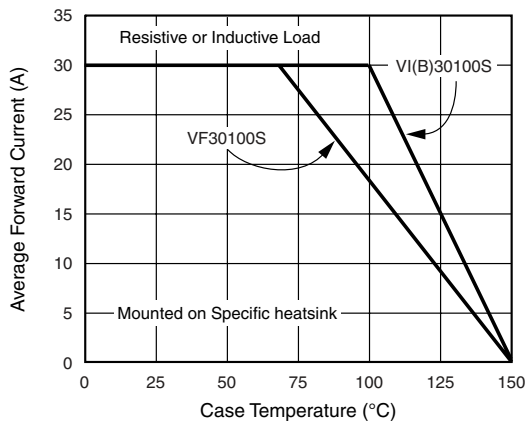

Figure 1. Forward Current Derating Curve

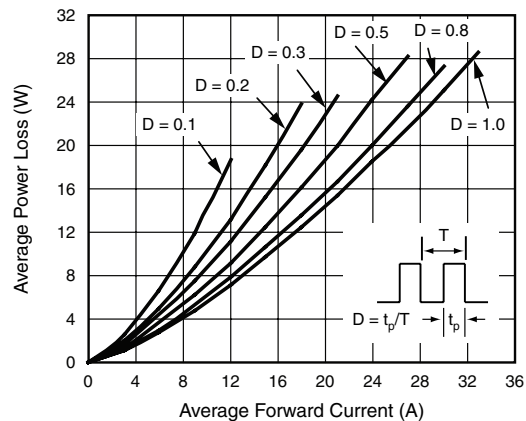

Figure 2. Forward Power Loss Characteristics

# New Product V30100S, VF30100S, VB30100S & VI30100S



Vishay General Semiconductor

## PACKAGE OUTLINE DIMENSIONS in inches (millimeters)

TO-220AB

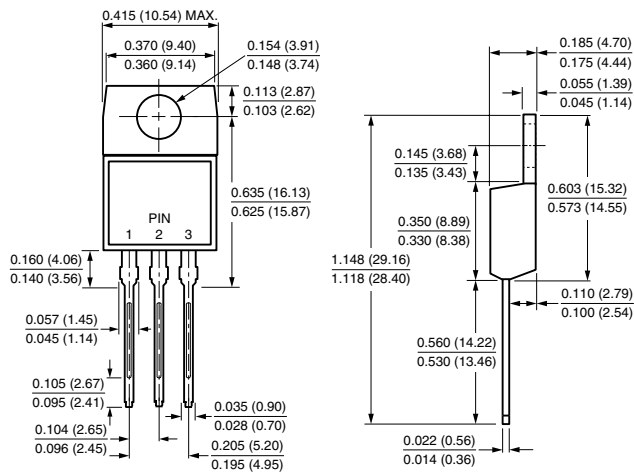

ITO-220AB

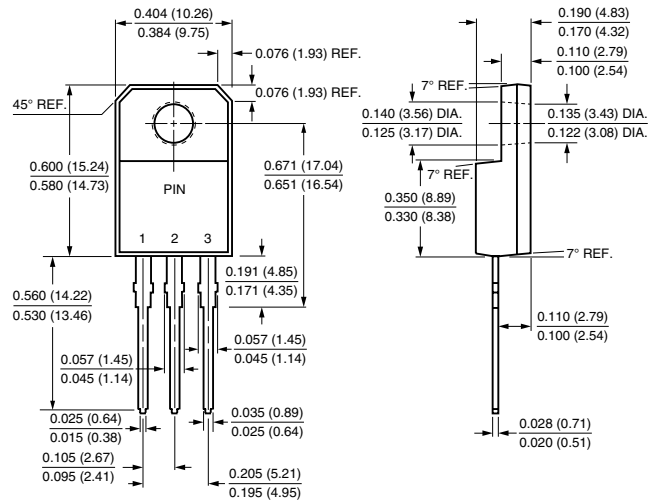

TO-262AA

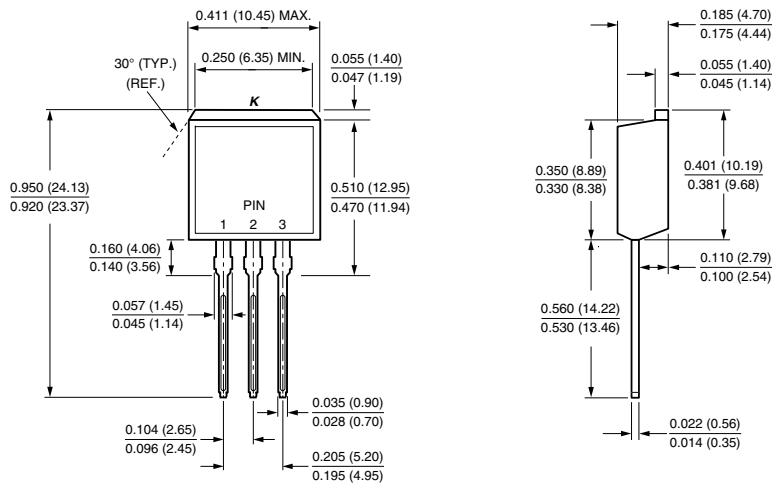

TO-263AB

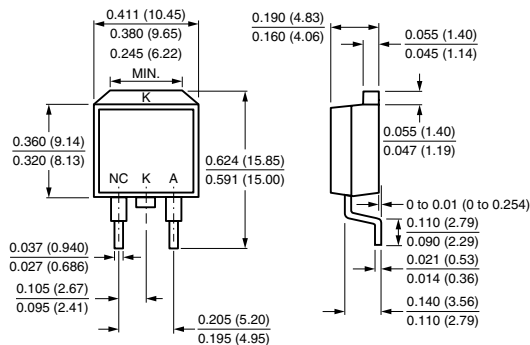

Mounting Pad Layout

