

Switchcraft®

[Previous Page](#) | [Return to Index](#) | [Next Page](#)

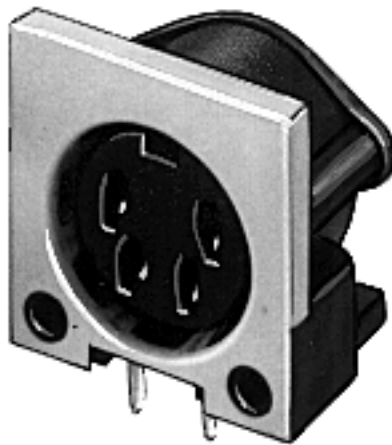

DIN RECEPTACLES

RIGHT-ANGLE SHIELDED RECEPTACLE for Printed Circuit Board Mounting

[click here to download a schematic drawing](#)

(you will need to have Adobe Acrobat installed on your system to do this)



Type 60PC4FS-typical Similar to 57PC5F - Typical, except flange surrounding face of insert is metal to provide through-grounding between plug and receptacle and to potential panel/chassis for common grounding.

ORDERING INFORMATION

Part Number	Description	Contact Arrangement
⌘57PC3FS	3 contacts at 180°	B
57PC5FS	5 contacts at 180°	F
⌘60PC4FS	4 contacts at 210°	D
61PC5FS	5 contacts at 240°	E
61PC6FS	6 contacts at 240°	G
62PC7FS	7 contacts at 270°	H
62PC8FS	8 contacts at 270°	N

SPECIFYING NOTE: Another series of receptacles with a trimmed metal flange .052 inch (1.32 mm) below housing top is available. Replace suffix "S" with "T" in part numbers above to specify these receptacles or contact Switchcraft. Mounting: #2 or #3 self-tapping screw.

⌘ Available on special order only; contact Switchcraft for price and delivery.

[Previous Page](#) | [Return to Index](#) | [Next Page](#)

To search a category please click on the corresponding icon:

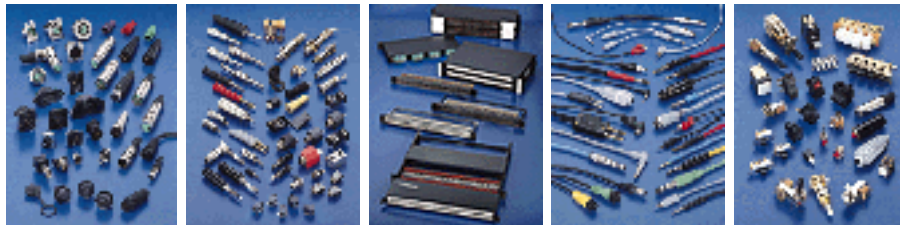

| [Connectors](#) | [Jacks and Plugs](#) |
| [Patch Panels, Patch Kits & Jackfields](#) | [Cable Assemblies and Patch Cords](#) | [Switches](#) |

All products shown are covered by Switchcraft's limited lifetime warranty.

| [Switchcraft home](#) |
[About Us](#) | [Products](#) | [What's New](#) | [Search](#) | [Contact Us](#)

DIN RECEPTACLES

RIGHT-ANGLE SHIELDED RECEPTACLE for printed circuit board mounting

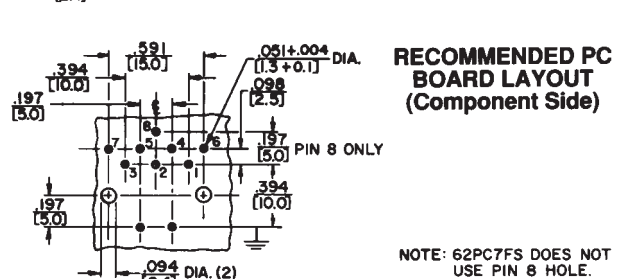
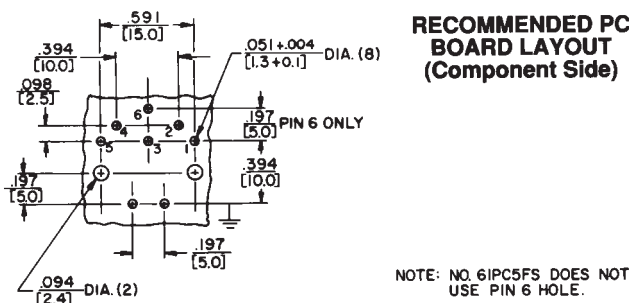
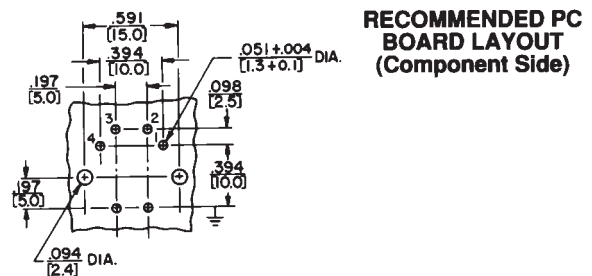
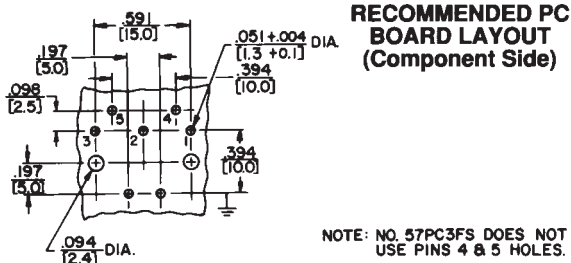
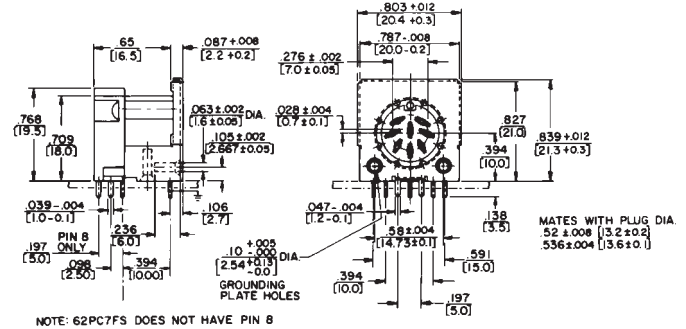
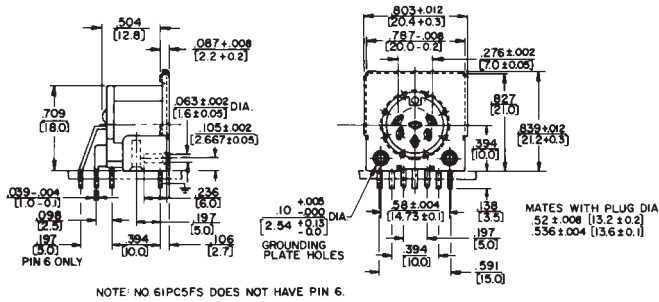
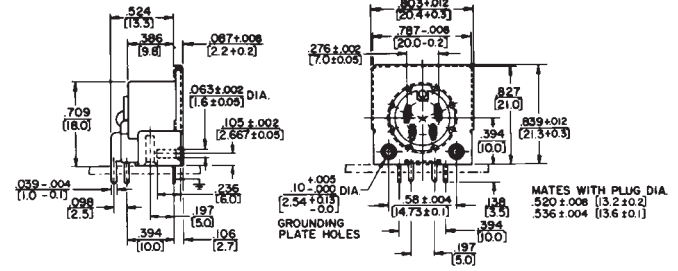
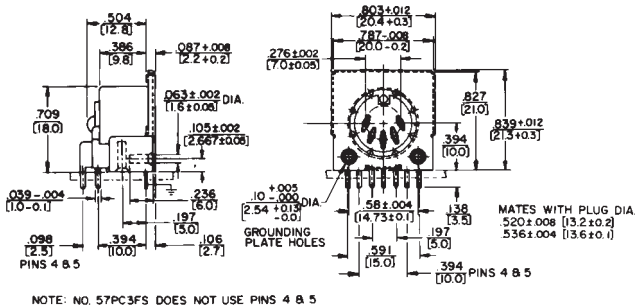

DIMENSIONS ARE FOR REFERENCE ONLY Inch
(mm)

NOTE: Contact your Switchcraft Representative for price and delivery.