



Falcon F45 Series Digital Panel Meter

- Full 4-1/2 Digit, Bright Red 0.56" (14.2mm) Display
- Broad Range Display Scaling
- Short 2.94" (74.7mm) Deep, 1/8 DIN Case
- Screw Terminal Connector for Easy Installation
- Four User-Settable Ranges: 200mA, 2mA, 20mA, 200mA
- Two Factory-Settable Ranges: 2A, 5A
- Optional Isolated 9-32VDC Power Supply



The Falcon Series digital indicators are premium quality 1/8 DIN meters for industrial applications. All Falcon units feature jumper-selectable decimal point (internal and on the connector for remote decimal point) and display scaling, providing wide application flexibility. In addition, most signal input ranges are easy to change with jumpers on the main board. The Falcon has a 0.56" bright red LED display for high visibility.

Compactly designed for applications requiring minimal rear panel depth, the Falcon fits a standard 1/8 DIN panel cutout (91.9mm x 45mm) and requires less than 3" behind the panel. A screw terminal connector is a standard feature for easy wiring of the power supply and signal input connections.

Installation and Panel Cutout

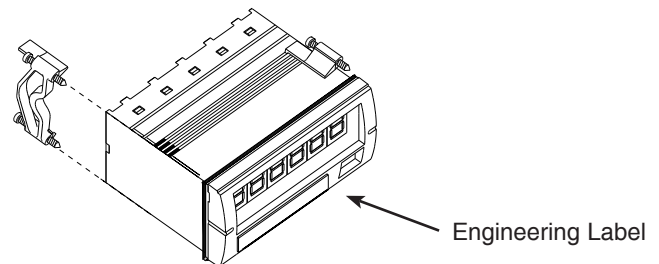
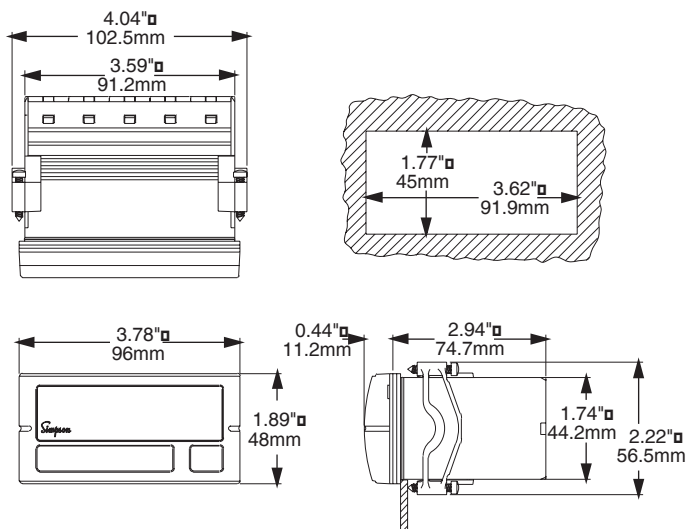

Mounting Requirements

The Falcon series 1/8 DIN indicators require a panel cutout of 1.77" (45mm) high by 3.62" (91.9mm) wide. To install the Falcon into a panel cutout, remove the clips from the side of the meter. Slide the meter through your panel cutout, then slide the mounting clips back on the meter. Press evenly to ensure a proper fit.

Engineering Label Placement

If replacement of the engineering unit label is required, place the tip of a ball-point pen into the small hole at the base of the engineering label in the bezel. Slide the label up until it pops out. Grasp and remove. Slide the new label half the distance in, then use the ball-point pen to slide it down into place.

Specifications

DISPLAY

Type: 7-segment, red LED
Height: 0.56" (14.2mm)
Decimal Point: 4-position programmable internally or at terminal block J112
Overrange indication: most significant digit = "1"; other digits blank
Polarity: Automatic, with "-" indication, "+" indication implied

POWER REQUIREMENTS

AC Voltages: 120 or 220VAC, ±10%
 50/60Hz
DC Voltages: 9-32VDC; 9V -1% and 32+1%
Power Consumption: 2VA

ACCURACY @258C

±0.05% of reading ±1 count
 2A ± 5 counts 5A ± 5 counts

ENVIRONMENTAL

Operating Temperature: 0 to 55°C
Storage Temperature: -10 to 60°C
Relative Humidity: 0 to 85% non-condensing

Temperature Coefficient:
 (±0.01% of input ±0.1 digit)/°C

Warm-up Time: Less than 15 minutes
Response Time: Less than 1 second

NOISE REJECTION

NMRR: 60dB, 50/60Hz
CMRR: (w/1kΩ unbalanced @60Hz):
 90dB min.

ANALOG TO DIGITAL CONVERSION

Technique: Dual slope integration

Rate: 2.5 samples per second, nominal

MECHANICAL

Bezel: 3.78" x 1.89" x .44"
 (96 x 48 x 11.2mm)

Depth: 2.94"(74.7mm)

Panel Cutout: 3.62" X 1.77"

(91.9 x 45mm 1/8 DIN)

Case Material: 94V-1, UL rated Noryl®

Weight: 9.0oz (255.1g)

INPUTS: DC Current

Input Range	Display Resolution	Maximum Output	Voltage Drop
200µA	100nA	20mA	200mV
2mA	1µA	20mA	
20mA	10µA	100mA	
200mA	100µA	500mA	
2A	1mA	2.2A	
5A	10mA	5.2A	

Wiring Diagram

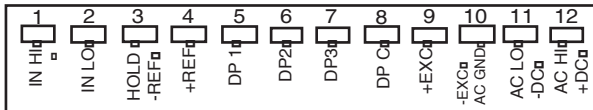

Input Signal: Connect the signal to be monitored to the IN HI and IN LO terminals. These are terminals #1 and #2.

Supply Power: Connect the power to terminals #11 and #12. Note that if AC power is applied, terminal #11 is for neutral, and terminal #12 is for hot. If DC power is used, terminal #11 is for -DC, and #12 is for +DC.

Display Hold: This feature allows you to hold the displayed value indefinitely. A remote switch or computer, etc. can be used to activate this feature. To activate feature, short circuit terminal block J112, pins 3 and 4 (Hold and DIG GND). This connection must be kept isolated from other circuitry. To hold multiple units, separate poles of the switch must be used to maintain the isolation.



These instruments are designed for maximum safety to the operator when mounted in a panel according to instructions. They are not to be used unmounted or for exploratory measurements in unknown circuits.

Decimal Point Selection

From terminal block J112: The decimal point can be set from the rear screw terminal block J112. Connect the appropriate DP point (DP 1, 2, 3, 4) to the DIG GND terminal. Internal jumper (J107) should be removed and stored on the last contact of J107.

Decimal Point	Connect
1.9999	DIG GND to DP1
19.999	DIG GND to DP2
199.99	DIG GND to DP3
750.0	DIG GND to DP4

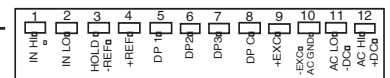

From main board: The decimal point can also be selected by accessing the main board. Move the push-on jumper J107 across the correct letter.

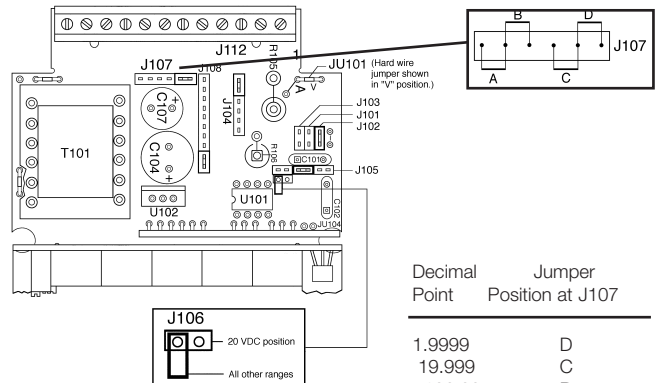

Decimal Point	Jumper Position at J107
1.9999	D
19.999	C
199.99	B
750.0V	A

Current Range Selection

All Falcon Indicators are configured initially per the customer specified part number. Range changes can easily be accomplished as follows: Disconnect power and pop the front bezel off with a small screwdriver, taking care to keep the gaskets in place. Unscrew the main board from the case with a Phillips head screwdriver, and slide the main board out. Note: If a new range is selected, the calibration procedure must also be performed. Only perform this section if a different function or range is required.

Input Range	J104 PJ	JU101 Jumper Position
200µA	A	A
2mA	B	A
20mA	D	A
200mA	E	A

Note: JU101 is a hard wire jumper and can be removed by cutting it. Resoldering the JU jumpers is not recommended. If this is required, or if a function is to be changed from volts to current, Simpson recommends returning the Falcon to the factory or an Authorized Service Center. After moving the jumpers to the desired location, put the Falcon back together and install in your panel, or proceed to calibration.



Example: 200mA input

* 2 Amp and 5 Amp ranges may be configured upon order by factory or Authorized Service Center

Calibration

The unit is calibrated at the factory per order. If you selected another range and moved the jumpers, your Falcon will need to be recalibrated. If parameters (HiE, etc.) are changed, scaling must be performed prior to calibration.

- 1) Remove the bezel with a small screwdriver.
- 2) Apply an input signal equal to full scale to the instrument.
- 3) Adjust the potentiometer R1 located on the upper left-hand side of the display board until display shows the full scale current.
- 4) Replace bezel carefully.

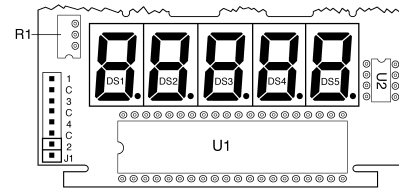

Application Example

A machine shop manager has been using a Falcon 4-1/2 digit unit to measure load current of a motor. The maximum load current has been 20 milliamps, however, the manager needs to update the system and has decided to replace the motor.

The new motor will have a maximum load current of 200 milliamps. The manager can simply configure and calibrate the same Falcon to the new range without purchasing a new unit.

After changing the appropriate jumpers on the main board (J104 from D to E), the unit is configured for 0(mA) for both LoE and Lo and 200(mA) for both HiE and Hi.

Next the indicator is calibrated and installed in series with the source and the motor. The input wires are connected to terminals one and two.

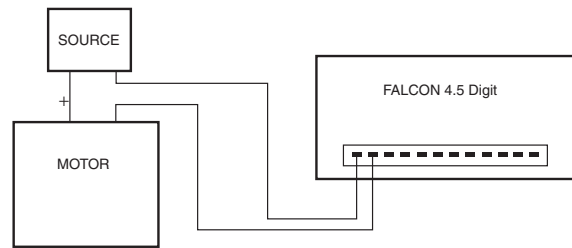

Ordering Information

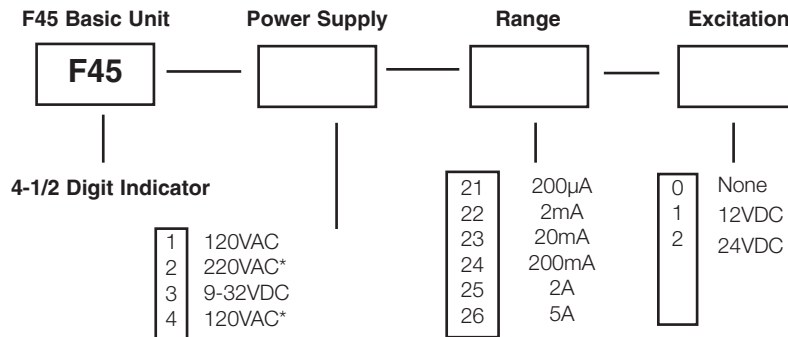

*Meets CE EMI CE-50082-1, EN-55022, EN-61000-3-2, EN-61000-3-3

Safety Symbols



The WARNING sign denotes a hazard. It calls attention to a procedure, practice, or the like, which, if not correctly performed or adhered to, could result in personal injury.



The CAUTION sign denotes a hazard. It calls attention to an operating procedure, practice, or the like, which, if not correctly adhered to, could result in damage to or destruction of part or all the instrument.

Accessories

Portable

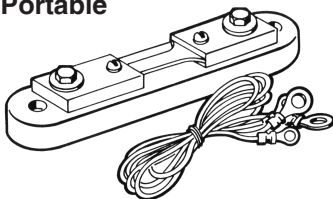

Switchboard

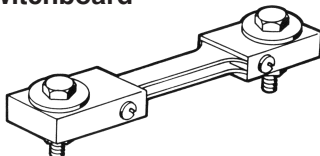

External shunts enable digital panel meters to indicate higher DC currents than can be provided with self contained internal shunt meters. The shunt is installed in series with the load and the source. The shunts provide a DCmV drop which is sent to the display unit. The Falcon can be scaled to display the actual current load between the load and the source. Simpson offers portable and switchboard shunts.

Each portable shunt includes 5' leads.

A portable or switchboard shunt should be used with Falcon series 200 mVDC meters. Specifications can be found on data sheet for DC Voltage.

Ordering Information

Portable Shunts (50mV)

Amps	Cat. Number
1	06700
5	06703
10	06704
15	06705
25	06707
30	06708
50	06709
75	06711
100	06713
150	06714
200	06715

Switchboard Shunts (50mV)

Amps	Cat. Number
100	06500
150	06503
200	06504
250	06505
300	06506
400	06507
500	06508