

Specifications:

Sound level Category	Low Sound Level
Mode of Operation	Continuous tone
Mounting	Panel (see note B)
Voltage Rating	30 to 120 Vac/dc
Frequency	2900 Hz \pm 500 Hz
Loudness (Min. Voltage)	55/68 dB(A) @ 2 FT and 30 Vac/dc
Loudness (Max Voltage)	65/78 dB(A) @ 2FT and 120 Vac/dc
Current Draw	1 mA Max @ 30 Vac/dc
Current Draw	6 mA Max @ 120 Vac/dc
Storage Temperature	-40°C to +85°C
Operating Temperature	-30°C to +65°C
Weight (Typical)	2.1 oz (59 g)
Housing	6/6 Nylon, Color Black
Options	For other options contact factory

Dimensions: Inches (mm)

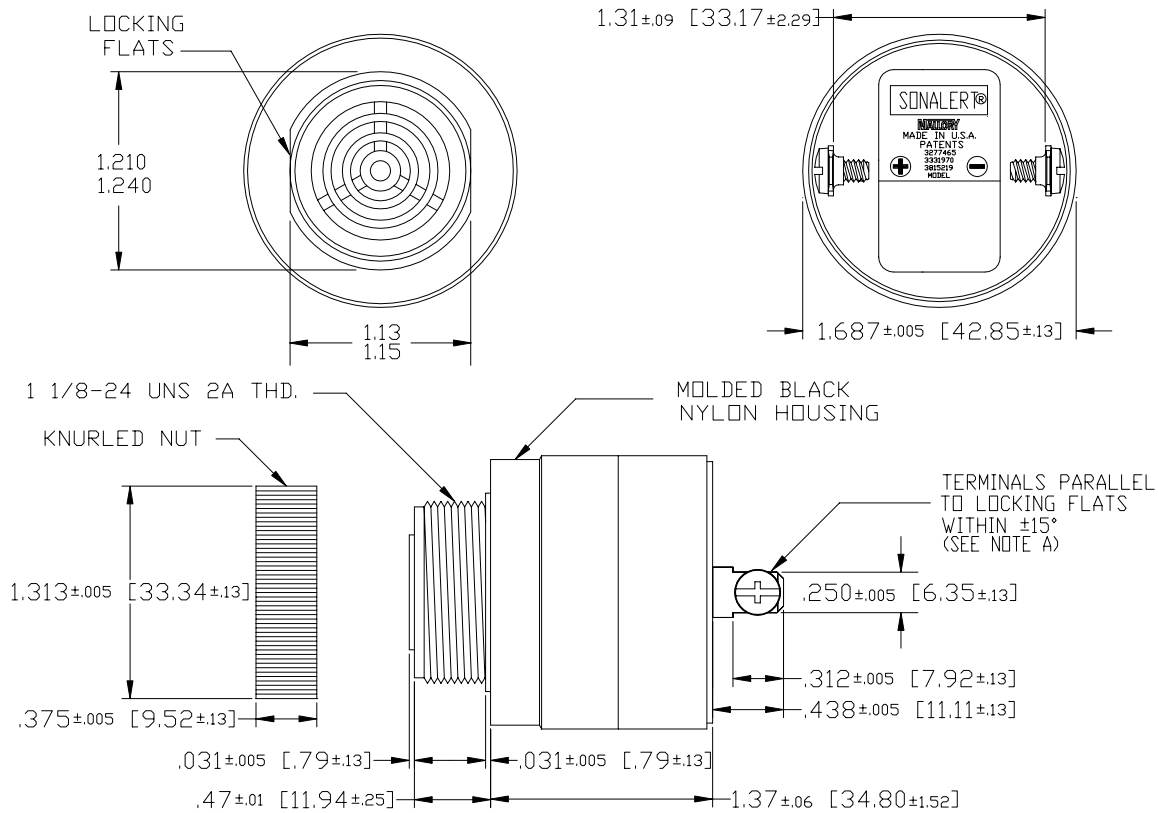

NOTE A: TERMINALS-.032 BRASS TIN PLATED, TAPPED FOR #6-32 SCREW. TWO #6-32 NICKEL PLATED BRASS SCREWS INCLUDED. WILL ACCEPT 1/4" QUICK CONNECT.

NOTE B: MOUNTING- REMOVE BLACK PLASTIC NUT AND INSERT THREADED FRONT THROUGH 1.25" HOLE PUNCHED IN PANEL, IF ORIENTATION IS NEEDED, NOTE LOCKING FLATS ON DRAWING. SCREW NUT BACK ON. DO NOT OVERTIGHTEN.