

# General-purpose Relay MY

## Versatile, Multi-featured, Miniature Power Relay for Sequence Control and Power Switching Applications

- Models with lockable test buttons now available.
- Multiple features available, including operation indicators (mechanical and LED indicators), lockable test button, built-in diode and CR (surge suppression), bifurcated contacts, etc.
- Environment-friendly cadmium-free contacts.
- Wide range of Sockets (PY, PYF Series) and optional parts.
- Max. Switching Current: 2-pole: 10 A, 4-pole: 5 A
- Provided with nameplate.
- RoHS Compliant.



## Ordering Information

### ■ Relays

#### Standard Coil Polarity

Type	Contact form	Model		
		Plug-in socket/solder terminals		
		Standard with LED indicator	With LED indicator and lockable test button	Without LED indicator
Standard	DPDT	MY2N	MY2IN	MY2
	4PDT	MY4N	MY4IN	MY4
	4PDT (bifurcated)	MY4ZN	MY4ZIN	MY4Z
With built-in diode (DC only)	DPDT	MY2N-D2	MY2IN-D2	---
	4PDT	MY4N-D2	MY4IN-D2	---
	4PDT (bifurcated)	MY4ZN-D2	MY4ZIN-D2	---
With built-in CR (220/240 VAC, 110/120 VAC only)	DPDT	MY2N-CR	MY2IN-CR	---
	4PDT	MY4N-CR	MY4IN-CR	---
	4PDT (bifurcated)	MY4ZN-CR	MY4ZIN-CR	---

#### Reverse Coil Polarity

Type	Contact form	Model	
		Plug-in socket/solder terminals	
		With LED indicator	With LED indicator and lockable test button
Standard (DC only)	DPDT	MY2N1	MY2IN1
	4PDT	MY4N1	MY4IN1
	4PDT (bifurcated)	MY4ZN1	MY4ZIN1
With built-in diode (DC only)	DPDT	MY2N1-D2	MY2IN1-D2
	4PDT	MY4N1-D2	MY4IN1-D2
	4PDT (bifurcated)	MY4ZN1-D2	MY4ZIN1-D2

**Note:** 1. When ordering, add the rated coil voltage to the model number(s), followed by "(S)". Rated coil voltages are given in the coil ratings table.  
Example: MY2 AC12(S)

↑  
Rated coil voltage

2. Arc barrier standard on all four-pole relays.
3. Other models also available, such as, three-pole versions, flangemount, PCB, etc. Contact your Omron Representative for details.

# Specifications

## ■ Coil Ratings

Rated voltage	Rated current		Coil resistance	Inductance (reference value)		Must operate	Must release	Max. voltage	Power consumption (approx.)	
	50 Hz	60 Hz		Arm. OFF	Arm. ON					
AC	6 V*	214.1 mA	183 mA	12.2 Ω	0.04 H	0.08 H	80% max.	30% min.	110%	1.0 to 1.2 VA (60 Hz)
	12 V	106.5 mA	91 mA	46 Ω	0.17 H	0.33 H				
	24 V	53.8 mA	46 mA	180 Ω	0.69 H	1.30 H				
	48/50 V*	24.7/25.7 mA	21.1/22.0 mA	788 Ω	3.22 H	5.66 H				
	110/120 V	9.9/10.8 mA	8.4/9.2 mA	4,430 Ω	19.20 H	32.1 H				
	220/240 V	4.8/5.3 mA	4.2/4.6 mA	18,790 Ω	83.50 H	136.4 H				
DC	6 V*	151 mA		39.8 Ω	0.17 H	0.33 H	10% min.			0.9 to 1.1 VA (60 Hz)
	12 V	75 mA		160 Ω	0.73 H	1.37 H				
	24 V	37.7 mA		636 Ω	3.20 H	5.72 H				
	48 V*	18.8 mA		2,560 Ω	10.60 H	21.0 H				
	100/110 V	9.0/9.9 mA		11,100 Ω	45.60 H	86.2 H				
										0.9 W

- Note:**
- The rated current and coil resistance are measured at a coil temperature of 23°C with tolerances of +15%/–20% for rated currents and ±15% for DC coil resistance.
  - Performance characteristic data are measured at a coil temperature of 23°C.
  - AC coil resistance and impedance are provided as reference values (at 60 Hz).
  - Power consumption drop was measured for the above data. When driving transistors, check leakage current and connect a bleeder resistor if required.
  - Rated voltage denoted by "\*" will be manufactured upon request. Ask your OMRON representative.

## ■ Contact Ratings

Item	2-pole		4-pole		4-pole (bifurcated)	
	Resistive load (cosφ = 1)	Inductive load (cosφ = 0.4, L/R = 7 ms)	Resistive load (cosφ = 1)	Inductive load (cosφ = 0.4, L/R = 7 ms)	Resistive load (cosφ = 1)	Inductive load (cosφ = 0.4, L/R = 7 ms)
Rated load	5 A, 250 VAC 5 A, 30 VDC	2 A, 250 VAC 2 A, 30 VDC	3 A, 250 VAC 3 A, 30 VDC	0.8 A, 250 VAC 1.5 A, 30 VDC	3 A, 250 VAC 3 A, 30 VDC	0.8 A, 250 VAC 1.5 A, 30 VDC
Carry current	10 A (see note)		5 A (see note)			
Max. switching voltage	250 VAC 125 VDC		250 VAC 125 VDC			
Max. switching current	10 A		5 A			
Max. switching capacity	2,500 VA 300 W	1,250 VA 300 W	1,250 VA 150 W	500 VA 150 W	1,250 VA 150 W	500 VA 150 W
Min. permissible load*	5 VDC, 1 mA		1 VDC, 1 mA		1 VDC, 100 μA	

\* Reference value.

**Note:** Do not exceed the carry current of a Socket in use.

## ■ Characteristics

<b>Contact resistance</b>		100 mΩ max.
<b>Operate time</b>		20 ms max.
<b>Release time</b>		20 ms max.
<b>Max. operating frequency</b>	<b>Mechanical</b>	18,000 operations/hr
	<b>Electrical</b>	1,800 operations/hr (under rated load)
<b>Insulation resistance</b>		1,000 MΩ min. (at 500 VDC)
<b>Dielectric withstand voltage</b>		2,000 VAC, 50/60 Hz for 1.0 min (1,000 VAC between contacts of same polarity)
<b>Vibration resistance</b>		Destruction:10 to 55 Hz, 1.0 mm double amplitude Malfunction:10 to 55 Hz, 1.0 mm double amplitude
<b>Shock resistance</b>		Destruction:1,000 m/s <sup>2</sup> (approx. 100G) Malfunction:200 m/s <sup>2</sup> (approx. 20G)
<b>Life expectancy</b>		See the following table.
<b>Ambient temperature</b>	<b>Operating</b>	-55°C to 70°C (-67°F to 158°F) with no icing (see note)
<b>Ambient humidity</b>	<b>Operating</b>	5% to 85% RH
<b>Weight</b>		Approx. 35 g

**Note:** The values given above are initial values.

## ■ Life Expectancy Characteristics

<b>Pole</b>	<b>Mechanical life (at 18,000 operations/hr)</b>	<b>Electrical life (at 1,800 operations/hr under rated load)</b>
2-pole	AC:50,000,000 operations min.	500,000 operations min.
4-pole	DC:100,000,000 operations min.	200,000 operations min.
4-pole (bifurcated)	20,000,000 operations min.	100,000 operations min.

## ■ Approved Standards

VDE, UL, CSA, IMQ, CE

## ■ Precautions

### Connections

Do not reverse polarity when connecting DC-operated Relays with built-in diodes or indicators or high-sensitivity DC-operated Relays.

### Mounting

Whenever possible, mount Relays so that it is not subject to vibration or shock in the same direction as that of contact movement.

# Engineering Data

## Maximum Switching Power

MY2



MY4, MY4Z



## Endurance

MY2 (Resistive Loads)



MY2 (Inductive Loads)



MY4 (Resistive Loads)



MY4 (Inductive Loads)



**MY4Z (Resistive Loads)**



**MY4Z (Inductive Loads)**



# Dimensions

Note: All units are in millimeters unless otherwise indicated.

## 2-Pole Models

MY2N

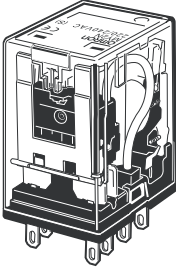

## 4-Pole Models

MY4N

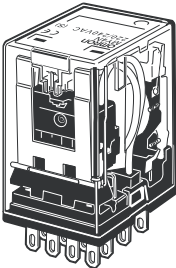

## Models with Test Button

MY2IN

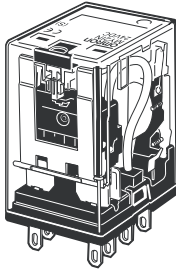

MY4IN

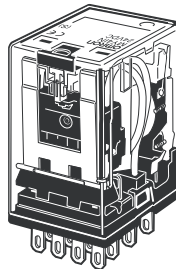

## Terminal Arrangement/Internal Connections (Bottom View)

**MY2**



**MY2N/MY2IN  
(AC Models)**



**MY2N/MY2IN  
(DC Models)**



**MY2N-D2/MY2IN-D2  
(DC Models Only)**



**MY2N-CR/MY2IN-CR  
(AC Models Only)**



**MY2N1/MY2IN1  
(DC Models Only)**

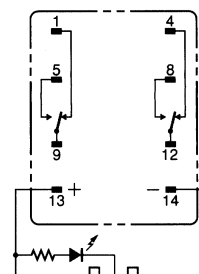

**MY2N1-D2/MY2IN1-D2  
(DC Models Only)**



**MY4(Z)**



**MY4(Z)N/MY4(Z)IN  
(AC Models)**



**MY4(Z)N/MY4(Z)IN  
(DC Models)**

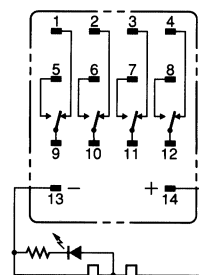

**MY4(Z)N-D/MY4(Z)IN-D2  
(DC Models Only)**



**MY4(Z)N-CR/MY4(Z)IN-CR  
(AC Models Only)**



**MY4(Z)N1/MY4(Z)IN1  
(DC Models Only)**

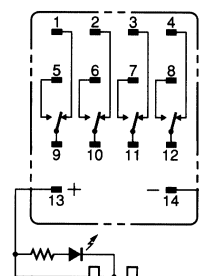

**MY4(Z)N1-D2/MY4(Z)N1-D2  
(DC Models Only)**



## Accessories (order separately)

### ■ Track-mounted Screwless Clamp Terminal Sockets

Item	Model			
	4-pole		2-pole	
Socket	PYF14S		PYF08S	
Clip & release lever	PYCM-14S		PYCM-08S	
Nameplate	R99-11 Nameplate for MY			
Socket bridge	PYDM-14SR	PYDM-14SB	PYDM-08SR	PYDM-08SB

**Note:** For complete specifications, see the datasheet at Omron's Knowledge Center on our website: [www.knowledge.omron.com](http://www.knowledge.omron.com).

### ■ Sockets

Poles	Front-connecting socket (DIN-track/screw mounting)	Back-connecting socket		PCB terminals
		Without clip	With clip	
2	PYF08A-E	PY08	PY08-Y1	PY08-02
	PYF08A-N			
4	PYF14A-E	PY14	PY14-Y1	PY14-02
	PYF14A-N			

### ■ Socket Specifications

Item	Pole	Model	Carry current	Dielectric withstand voltage	Insulation resistance (see note 2)
Screwless clamp terminal socket	2	PYF08S	10 A	2,000 VAC, 1 min	Less than 1,000 MΩ
	4	PYF14S	5 A		
Track-mounted socket	2	PYF08A-E	7 A	2,000 VAC, 1 min	1,000 MΩ min.
		PYF08A-N (see note 3)	7 A (see note 4)		
	4	PYF14A-E	5 A		
		PYF14A-N (see note 3)	5 A (see note 4)		
Back-connecting socket	2	PY08(-Y1)	7 A	1,500 VAC, 1 min	100 MΩ min.
		PY08-02			
	4	PY14(-Y1)	3 A		
		PY14-02			

- Note:**
- The values given above are initial values.
  - The values for insulation resistance were measured at 500 V at the same place as the dielectric strength.
  - The maximum operating ambient temperature for the PYF08A-N and PYF14A-N is 55°C.
  - When using the PYF08A-N or PYF14A-N at an operating ambient temperature exceeding 40°C, reduce the current to 60%.
  - The MY2(S) can be used at 70°C with a carry current of 7 A.

### ■ Socket Hold-down Clip Pairing

Relay type	Poles	Front-connecting socket (DIN-track/screw mounting)		Back-connecting socket			
				Solder terminals		PCB terminals	
		Socket	Clip	Socket	Clip	Socket	Clip
Without 2-pole test button	2	PYF08A-E	PYC-A1	PY08	PYC-P PYC-P2	PY08-02	PYC-P PYC-P2
		PYF08A-N					
Without 2-pole test button	4	PYF14A-E	PYC-A1	PY14	PYC-P PYC-P2	PY14-02	PYC-P PYC-P2
		PYF14A-N					
2-pole test button	2	PYF08A-E	PYC-E1	PY08	PYC-P2	PY08-02	PYC-P2
		PYF08A-N					



## ■ Mounting Plates for Sockets

Socket model	For 1 socket	For 18 sockets	For 36 sockets
PY08, PY14	PYP-1	PYP-18	PYP-36

**Note:** PYP-18 and PYP-36 can be cut into any desired length in accordance with the number of Sockets.

## ■ DIN Rail Track and Accessories

Description	Model
Mounting rail (length = 500 mm)	PFP-50N
Mounting rail (length = 1,000 mm)	PFP-100N, PFP-100N2
End Plate	PFP-M
Spacer	PFP-S

# ■ Dimensions

Unit: mm (inch)

Socket	Dimensions	Terminal arrangement/ internal connections (top view)	Mounting holes
			 <p>(TOP VIEW)</p> <p><b>Note:</b> Track mounting is also possible. Refer to page 12 for supporting tracks.</p>
			 <p>(TOP VIEW)</p> <p><b>Note:</b> Track mounting is also possible. Refer to page 12 for supporting tracks.</p>
	 <p><b>Note:</b> The PY08-Y1 includes sections indicated by dotted lines.</p>		
			

Socket	Dimensions	Terminal arrangement/ internal connections (top view)	Mounting holes
<p>PYF08A-N</p> 			 <p><b>Note:</b> Track mounting is also possible. Refer to page 12 for supporting tracks.</p>
<p>PYF14A-N</p> 			 <p><b>Note:</b> Track mounting is also possible. Refer to page 12 for supporting tracks.</p>
<p>PY14/PY14-Y1</p> 	 <p><b>Note:</b> The PY14-Y1 includes sections indicated by dotted lines.</p>		
<p>PY14-02</p> 			

**Note:** Use a panel with plate thickness of 1 to 2 mm for mounting the Sockets.

Socket	Dimensions	Terminal arrangement/ internal connections (top view)	Mounting height (with lever)
<b>PYF14S</b> 		 <b>Note:</b> Pole-2 and pole-3 cannot be used with the MY2 type. Use pole-1 (terminal numbers 11, 14, 12) and pole-4 (terminal numbers 41, 44, 42).	 <b>Note:</b> Track mounting only.
<b>PYF08S</b> 			 <b>Note:</b> Track mounting only.

### Socket Bridge



Model number	Length L (mm)	Color of insulating coating
<b>PYDM-14SR</b>	27.5±0.3	Red
<b>PYDM-14SB</b>		Blue
<b>PYDM-08SR</b>	19.7±0.3	Red
<b>PYDM-08SB</b>		Blue

Item	Characteristic
Rated ON current	10 A
Rated insulation voltage	250 VAC
Temperature rise	35°C max.
Dielectric strength	1,500 VAC for 1 minute
Ambient operating temperature	-55 to 70°C

- Note:**
- The relationship between the model number, the length L, and the color of the insulating coating is shown above.
  - The insulating coating must be able to withstand a voltage of 1,500 V for 1 minute. Use either PE or PA as the material of the insulating coating.

- The positions of the ends of the insulating coating must not vary more than 0.5 mm.
- The characteristics of the socket bridge are shown above.

## Clip and Release Levers

PYCM-14S



PYCM-08S

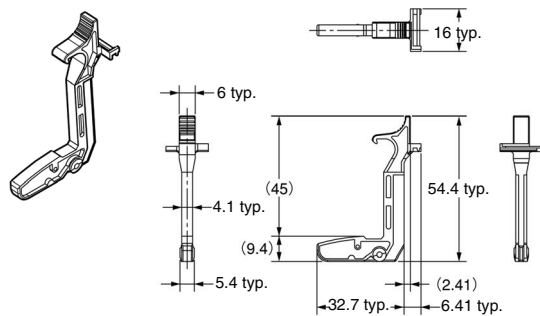

## Hold-down Clips

PYC-A1

(2 pcs per set)



PYC-E1

(2 pcs per set)

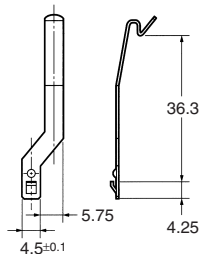

PYC-P



PYC-P2



## ■ Mounting Plates for Back-connecting Sockets

PYP-1



PYP-36



PYP-18



## ■ Mounting Track and Accessories

### DIN Rail Track

PFP-50N/PFP-100N



Note: The figure in the parentheses is for PFP-50N.

PFP-100N2



### End Plate

PFP-M



## Spacer

PFP-S



### ■ Approved Standards

#### VDE Recognitions (File No. 112467UG, IEC 255, VDE 0435)

No. of poles	Coil ratings	Contact ratings	Operations
2	6, 12, 24, 48/50, 100/110 110/120, 200/220, 220/240 VAC	10 A, 250 VAC (cosφ=1) 10 A, 30 VDC (L/R=0 ms)	10 x 10 <sup>3</sup>
4	6, 12, 24, 48, 100/110, 125 VDC	5 A, 250 VAC (cosφ=1) 5 A, 30 VDC (L/R=0 ms)	100 x 10 <sup>3</sup> MY4Z AC; 50 x 10 <sup>3</sup>

#### UL Recognized (File No. 41515)

No. of poles	Coil ratings	Contact ratings	Operations
2	6 to 240 VAC 6 to 125 VDC	10 A, 30 VDC (general purpose), 40°C 10 A, 250 VAC (general purpose), 40°C	6 x 10 <sup>3</sup>
4		5 A, 30 VDC (general purpose), 40°C (Same polarity) 5 A, 250 VAC (general purpose), 40°C (Same polarity)	

#### CSA Certified (File No. LR31928)

No. of poles	Coil ratings	Contact ratings	Operations
2	6 to 240 VAC 6 to 125 VDC	10 A, 30 VDC 10 A, 250 VAC	6 x 10 <sup>3</sup>
4		5 A, 250 VAC (same polarity) 5 A, 30 VDC (same polarity)	

#### IMQ (File No. EN013 to 016)

No. of poles	Coil ratings	Contact ratings	Operations
2	6, 12, 24, 48/50, 100/110 110/120, 200/220, 220/240 VAC	10 A, 30 VDC 10 A, 250 VAC	10 x 10 <sup>3</sup>
4	6, 12, 24, 48, 100/110, 125 VDC	5 A, 250 VAC 5 A, 30 VDC	100 x 10 <sup>3</sup> MY4Z AC; 50 x 10 <sup>3</sup>

#### LR Recognitions (File No. 98/10014)

No. of poles	Coil ratings	Contact ratings	Operations
2	6 to 240 VAC 6 to 125 VDC	10 A, 250 VAC (resistive) 2 A, 250 VAC (PF0.4) 10 A, 30 VDC (resistive) 2 A, 30 VDC (L/R=7 ms)	50 x 10 <sup>3</sup>
4		5 A, 250 VAC (resistive) 0.8 A, 250 VAC (PF0.4) 5 A, 30 VDC (resistive) 1.5 A, 30 VDC (L/R=7 ms)	50 x 10 <sup>3</sup>

## SEV Listings (File No. 99.5 50902.01)

No. of poles	Coil ratings	Contact ratings	Operations
2	6 to 240 VAC 6 to 125 VDC	10 A, 250 VAC 10 A, 30 VDC	10 x 10 <sup>3</sup>
4		5 A, 250 VAC 5 A, 30 VDC	100 x 10 <sup>3</sup> MY4Z AC; 50 x 10 <sup>3</sup>

- Note: 1.** The rated values approved by each of the safety standards (eg., UL, CSA, VDE, and SEV) may be different from the performance characteristics individually defined in this catalog.
- 2.** In the interest of product improvement, specifications are subject to change.

## PYF-S Installation Notes

### Tools

A flat-blade screwdriver should be used to mount the cables.

### Applicable Screwdriver

- Flat-blade, Parallel-tip, 2.5 mm diameter (3.0 mm max.)



Examples: FACOM AEF.2.5 × 75E (AEF. 3 × 75E)  
 VESSEL No. 9900(-)2.5 × 75 (No. 9900(-)3 × 100)  
 WAGO 210-119  
 WIHA 260/2.5 × 40 (260/3 × 50)

\*Chamfering the tip of the driver improves insertion when used as an exclusive tool.

### Applicable Wires

#### Applicable Wire Sizes

0.2 to 1.5 mm<sup>2</sup>, AWG24 to AWG16

#### Applicable Wire Type

Solid wires, stranded wires, flexible wires, or wires with ferules can be used.

(See note 1.)  $2.2 \leq \text{Diameter } D \text{ (mm)} \leq 3.2$  (3.5: see note 2.)

Conductor diameter  $d$  (mm) or length of sides  $a$  and  $b$  (mm)  $\leq 1.9$



- Note: 1.** If the overall diameter of the wire is less than 2.2 mm, do not insert the wire past the conductor. Refer to the following diagrams.



- 2.** If the overall diameter of the wire is over 3.2 mm, it will be difficult to use double wiring.



## Examples of Applicable Wires (Confirmed Using Catalog Information)

Type of wire	Conductor type	See note 1, above.	Recommended wire sizes	See note 2, above.
Equipment wire 2491X	Flexible		0.5, 0.75, 1.0 mm <sup>2</sup>	1.5 mm <sup>2</sup>
BS6004	Solid	0.5 mm <sup>2</sup>		
Switchgear BS6231	Solid		1.0 mm <sup>2</sup>	1.5 mm <sup>2</sup>
Switchgear BS6231	Flexible		0.5, 0.75 mm <sup>2</sup>	1.0 mm <sup>2</sup>
Tri-rated control and switchgear	Flexible		0.5, 0.75, 1.0, 1.5 mm <sup>2</sup>	
Conduit	Stranded		1.5 mm <sup>2</sup>	
UL1007	Flexible	18AWG	16AWG	
UL1015	Flexible		18AWG, 16AWG	
UL1061	Flexible	18AWG		
UL1430	Flexible	18AWG	16AWG	

### ■ Wiring

Use wires of the applicable sizes specified above. The length of the exposed conductor should be 8 to 9 mm.



Fig. 1 Exposed Conductor Length

Use the following wiring procedure.

1. Insert the specified screwdriver into the release hole located beside the wire connection hole where the wire is to be inserted.



Fig. 2 Wire Connection Holes and Release Holes



Fig. 3 Section A-A of Fig. 2



2. Insert the exposed conductor into the wire connection hole.



3. Pull out the screwdriver.



**Note:** Use no more than 2 wires per terminal, 1 wire per hole.

## ■ Precautions

### Precautions for Connection

- Do not move the screwdriver up, down, or from side to side while it is inserted in the hole. Doing so may cause damage to internal components (e.g., deformation of the coil spring or cracks in the housing) or cause deterioration of insulation.
- Do not insert the screwdriver at an angle. Doing so may break the side of socket and result in a short-circuit.



- Do not insert two or more wires in the hole. Wires may come in contact with the spring causing a temperature rise or be subject to sparks. (There are two wiring holes for each terminal.)



- Insert the screwdriver along the hole wall as shown below.



- If lubricating liquid, such as oil, is present on the tip of screwdriver, the screwdriver may fall out resulting in injury to the operator.
- Insert the screwdriver into the bottom of the hole. It may not be possible to connect cables properly if the screwdriver is inserted incorrectly.

### General Precautions

- Use the clip to prevent relays floating or falling out of the socket.
- Do not use the product if it has been dropped on the ground. Dropping the product may adversely affect performance.
- Confirm that the socket is securely attached to the mounting track before wiring. If the socket is mounted insecurely it may fall and injure the operator.
- Ensure that the socket is not charged during wiring and maintenance. Not doing so may result in electric shock.
- Do not pour water or cleansing agents on the product. Doing so may result in electric shock.
- Do not use the socket in locations subject to solvents or alkaline chemicals.
- Do not use the socket in locations subject to ultraviolet light (e.g., direct sunlight). Doing so may result in markings fading, rust, corrosion, or resin deterioration.
- Do not dispose of the product in fire.

### Removing from Mounting Rail

To remove the socket from the mounting rail, insert the tip of screwdriver in the fixture rail, and move it in the direction shown below.



**ALL DIMENSIONS SHOWN ARE IN MILLIMETERS.**

To convert millimeters into inches, multiply by 0.03937. To convert grams into ounces, multiply by 0.03527.

## Read and Understand This Catalog

Please read and understand this catalog before purchasing the products. Please consult your OMRON representative if you have any questions or comments.

## Warranty and Limitations of Liability

### WARRANTY

OMRON's exclusive warranty is that the products are free from defects in materials and workmanship for a period of one year (or other period if specified) from date of sale by OMRON.

OMRON MAKES NO WARRANTY OR REPRESENTATION, EXPRESS OR IMPLIED, REGARDING NON-INFRINGEMENT, MERCHANTABILITY, OR FITNESS FOR PARTICULAR PURPOSE OF THE PRODUCTS. ANY BUYER OR USER ACKNOWLEDGES THAT THE BUYER OR USER ALONE HAS DETERMINED THAT THE PRODUCTS WILL SUITABLY MEET THE REQUIREMENTS OF THEIR INTENDED USE. OMRON DISCLAIMS ALL OTHER WARRANTIES, EXPRESS OR IMPLIED.

### LIMITATIONS OF LIABILITY

OMRON SHALL NOT BE RESPONSIBLE FOR SPECIAL, INDIRECT, OR CONSEQUENTIAL DAMAGES, LOSS OF PROFITS OR COMMERCIAL LOSS IN ANY WAY CONNECTED WITH THE PRODUCTS, WHETHER SUCH CLAIM IS BASED ON CONTRACT, WARRANTY, NEGLIGENCE, OR STRICT LIABILITY.

In no event shall the responsibility of OMRON for any act exceed the individual price of the product on which liability is asserted.

IN NO EVENT SHALL OMRON BE RESPONSIBLE FOR WARRANTY, REPAIR, OR OTHER CLAIMS REGARDING THE PRODUCTS UNLESS OMRON'S ANALYSIS CONFIRMS THAT THE PRODUCTS WERE PROPERLY HANDLED, STORED, INSTALLED, AND MAINTAINED AND NOT SUBJECT TO CONTAMINATION, ABUSE, MISUSE, OR INAPPROPRIATE MODIFICATION OR REPAIR.

## Application Considerations

### SUITABILITY FOR USE

OMRON shall not be responsible for conformity with any standards, codes, or regulations that apply to the combination of products in the customer's application or use of the products.

At the customer's request, OMRON will provide applicable third party certification documents identifying ratings and limitations of use that apply to the products. This information by itself is not sufficient for a complete determination of the suitability of the products in combination with the end product, machine, system, or other application or use.

The following are some examples of applications for which particular attention must be given. This is not intended to be an exhaustive list of all possible uses of the products, nor is it intended to imply that the uses listed may be suitable for the products:

- Outdoor use, uses involving potential chemical contamination or electrical interference, or conditions or uses not described in this catalog.
- Nuclear energy control systems, combustion systems, railroad systems, aviation systems, medical equipment, amusement machines, vehicles, safety equipment, and installations subject to separate industry or government regulations.
- Systems, machines, and equipment that could present a risk to life or property.

Please know and observe all prohibitions of use applicable to the products.

NEVER USE THE PRODUCTS FOR AN APPLICATION INVOLVING SERIOUS RISK TO LIFE OR PROPERTY WITHOUT ENSURING THAT THE SYSTEM AS A WHOLE HAS BEEN DESIGNED TO ADDRESS THE RISKS, AND THAT THE OMRON PRODUCTS ARE PROPERLY RATED AND INSTALLED FOR THE INTENDED USE WITHIN THE OVERALL EQUIPMENT OR SYSTEM.

### PROGRAMMABLE PRODUCTS

OMRON shall not be responsible for the user's programming of a programmable product, or any consequence thereof.

## Disclaimers

### CHANGE IN SPECIFICATIONS

Product specifications and accessories may be changed at any time based on improvements and other reasons.

It is our practice to change model numbers when published ratings or features are changed, or when significant construction changes are made. However, some specifications of the products may be changed without any notice. When in doubt, special model numbers may be assigned to fix or establish key specifications for your application on your request. Please consult with your OMRON representative at any time to confirm actual specifications of purchased products.

### DIMENSIONS AND WEIGHTS

Dimensions and weights are nominal and are not to be used for manufacturing purposes, even when tolerances are shown.

### PERFORMANCE DATA

Performance data given in this catalog is provided as a guide for the user in determining suitability and does not constitute a warranty. It may represent the result of OMRON's test conditions, and the users must correlate it to actual application requirements. Actual performance is subject to the OMRON Warranty and Limitations of Liability.

### ERRORS AND OMISSIONS

The information in this document has been carefully checked and is believed to be accurate; however, no responsibility is assumed for clerical, typographical, or proofreading errors, or omissions.



**OMRON ELECTRONICS LLC • THE AMERICAS HEADQUARTERS** • Schaumburg, IL USA • 847.843.7900 • 800.556.6766 • [www.omron247.com](http://www.omron247.com)

**OMRON CANADA, INC. • HEAD OFFICE**

Toronto, ON, Canada • 416.286.6465 • 866.986.6766  
[www.omron247.com](http://www.omron247.com)

**OMRON ELETRÔNICA DO BRASIL LTDA • HEAD OFFICE**

São Paulo, SP, Brasil • 55.11.2101.6300 • [www.omron.com.br](http://www.omron.com.br)

**OMRON ELECTRONICS MEXICO SA DE CV • HEAD OFFICE**

Apodaca, N.L. • 52.811.156.99.10 • 001.800.556.6766 • [mela@omron.com](mailto:mela@omron.com)

**OMRON ARGENTINA • SALES OFFICE**

Cono Sur • 54.11.4783.5300

**OMRON CHILE • SALES OFFICE**

Santiago • 56.9.9917.3920

**OTHER OMRON LATIN AMERICA SALES**

54.11.4783.5300

**OMRON EUROPE B.V.** Wegalaan 67-69, NL-2132 JD, Hoofddorp, The Netherlands. Tel: +31 (0) 23 568 13 00 Fax: +31 (0) 23 568 13 88 [www.industrial.omron.eu](http://www.industrial.omron.eu)