

# Agilent N9923A FieldFox RF Vector Network Analyzer 2 MHz to 4/6 GHz

Data Sheet



Agilent Technologies

## Table of Contents

Definitions.....	2
FieldFox RF Vector Network Analyzer.....	3
Cable and Antenna Analyzer (Option 305).....	10
External USB Power Sensor Support (Option 302).....	10
Vector Voltmeter (Option 308).....	11
Block Diagram.....	11
General Information.....	12
N9923A FieldFox RF VNA Options.....	14
N9923A Upgrade Options.....	15
Calibration Kits.....	15
FieldFox Data Link Software.....	16

## Definitions

### **Specification (spec.)**

Warranted performance. Specifications include guardbands to account for the expected statistical performance distribution, measurement uncertainties, and changes in performance due to environmental conditions. The following conditions must be met:

- FieldFox has been turned on for 10 minutes.
- FieldFox is within its calibration cycle.
- FieldFox remains at a stable surrounding environment temperature (between -10 to 55 °C) for 90 minutes prior to turn-on and during operation.

### **Typical (typ.)**

Expected performance of an average unit at a stable temperature between 20 °C to 30 °C for 90 minutes prior to turn-on and during operation; does not include guardbands. It is not covered by the product warranty. The FieldFox must be within its calibration cycle.

### **Nominal (nom.)**

A general, descriptive term or design parameter. It is not tested, and not covered by the product warranty.

### **Calibration**

The process of measuring known standards to characterize an instrument's systematic (repeatable) errors.

### **Corrected (residual)**

Indicates performance after error correction (calibration). It is determined by the quality of calibration standards and how well "known" they are, plus system repeatability, stability, and noise.

# FieldFox RF Vector Network Analyzer

Description	Specification	Supplemental Information
<b>Frequency range</b>		
	2 MHz to 4 GHz	Option 104
	2 MHz to 6 GHz	Option 106
<b>Frequency reference</b>		
Accuracy	±2 ppm	
Aging rate	±1 ppm/yr	
Temperature stability	±1 ppm over -10 to 55 °C	
Frequency resolution	1 Hz < 3.2 GHz 1.2 Hz > 3.2 GHz	
<b>Data points</b>	101, 201, 401, 601, 801, 1001, (10,001 with SCPI)	
<b>Measurements</b>	S11, S21 magnitude and phase S22, S12 magnitude and phase (option 122)	
<b>Formats</b>	Log magnitude, linear magnitude, VSWR, phase, Smith chart, polar, group delay	
<b>Directivity</b>		
Corrected, with full two-port calibration, N9910X-800 calibration kit (option 122)	42 dB	
Corrected with QuickCal (option 112)		38 dB (typical)
<b>System impedance</b>	50Ω (nominal)	75Ω with appropriate adapter and calibration kit
<b>System dynamic range<sup>1</sup></b> (IF bandwidth = 300 Hz)		
2 MHz to 6 GHz	90 dB	100 dB (typical)
<b>Receiver dynamic range<sup>2</sup></b> (IF bandwidth = 300 Hz)		
2 MHz to 6 GHz		104 dB (typical)
<b>Receiver compression level</b> at 0.1 dB compression		+10 dBm (typical)
<b>Test port output power</b>		
High		+5 dBm (nominal)
Low		-40 dBm (nominal)
<b>Test port 1 or 2 damage level</b>		
2 MHz to 6 GHz	+23 dBm	
<b>Trace noise</b> (high output power, IF bandwidth = 300 Hz)		
Magnitude		< 3 GHz, 0.008 dB rms (typical) > 3 GHz, 0.01 dB rms (typical)
<b>Temperature stability</b>		
Stability magnitude		0.01 dB/°C at 23 °C ±5 °C (typical)
<b>IF bandwidths</b>	300 Hz, 1 kHz, 3 kHz, 10 kHz, 30 kHz	

1. System dynamic range = source maximum output power - receiver noise floor

2. Receiver dynamic range = receiver maximum input level - receiver noise floor

## FieldFox RF Vector Network Analyzer (continued)

Description	Information
<b>Display range</b>	
Log magnitude S11 or S22	-1000 to 1000 dB
Log magnitude S21 or S12	-1000 to 1000 dB
Log magnitude resolution	0.01 dB
Phase	-180 to +180 degrees
Phase resolution	0.01 degrees
VSWR	1.01 to 1000
VSWR resolution	0.01
<b>Averaging</b>	2 to 999 Averages vector data on each successive sweep
<b>Number of traces</b>	Four traces available. Tr1, Tr2, Tr3, Tr4
<b>Data markers</b>	Each trace has six independent markers that can be displayed simultaneously. Delta markers are available for each marker.
<b>Marker formats</b>	Default marker format is the trace format. In Smith chart or polar format, [Real +Imag] or [Mag and Phase] formats are also available.
<b>Marker functions</b>	Peak, Next Peak, Peak Left, Peak Right, Mkr→ Center, Min Search, Peak Excursion, Peak Threshold
<b>Sweep type</b>	Linear
<b>Sweep time</b>	Set sweep time in seconds
<b>Sweep trigger</b>	Continuous, single
<b>Display formats</b>	Single-trace Dual-trace overlay (both traces on one graticule) Dual-trace split (each trace on separate graticules) Three-trace split (each trace on separate graticules) Quad-trace split (each trace on separate graticules)
<b>Display data</b>	Display data, memory, data and memory, or data math
<b>Trace math</b>	Vector division or subtraction of current linear measurement values and memory data.
<b>Scale</b>	Autoscale, scale, reference level, reference position Autoscale: Automatically selects scale resolution and reference value to center the trace. Autoscale all scales all visible traces.
<b>Title</b>	Add custom titles to the display.
<b>Limit lines</b>	Define test limit lines that appear on the display for go/no go testing. Lines may be any combination of horizontal, sloping lines, or discrete data points. Each trace can have its own limit line.
<b>Calibration Types</b>	
CalReady	Each FieldFox is calibrated at the test port.
Frequency response	Simultaneous magnitude and phase correction of frequency response errors for either reflection or transmission measurements.
Enhanced response	Corrects for frequency response and source match for transmission measurements, and corrects for reflection frequency response, directivity and source match errors for reflection measurements.
1-port calibration	Corrects for directivity, frequency response, and source match errors.

## FieldFox RF Vector Network Analyzer (continued)

Description	Information
2-port calibration (with option 122)	Full 12-term error correction. Corrects for directivity, source match, reflection frequency response, load match, and transmission frequency response for an N9923A with option 122, full two-port S-parameters. Unknown thru and QSOLT are both available.
1-port QuickCal (with option 112)	Corrects for directivity, frequency response, and source match errors, using internal and external standards.
2-port QuickCal (with option 112 and 122)	Full 12-term error correction. Corrects for directivity, source match, reflection frequency response, load match, and transmission frequency response.
Guided calibration wizard	FieldFox's calibration wizard recommends a calibration type and calibration kit based on selected parameters and connector types. Alternatively, users can select their own calibration type and calibration kit.
Interpolated error correction	With any type of accuracy enhancement applied, interpolated mode recalculates the error coefficients when the test frequencies are changed. The number of points can be increased or decreased and the start/stop frequencies can be changed, but the resulting frequency span must be a subset of the original calibration frequency span.

## Corrected measurement uncertainty, 2-port or enhanced response cal, high port power (default power)

Applies to N9923A, N9910X-800 Type-N (m) calibration kit, full 2-port or enhanced response calibration, IF bandwidth = 300 Hz, no averaging, data based on high port power of +5 dBm, 2-port cal available only with option 122.

	Corrected performance 2 MHz to 4 GHz	Corrected performance >4 GHz to 6 GHz
Directivity	42 dB	42 dB
Source match	36 dB	36 dB
Load match	40 dB	38 dB
Transmission tracking	$\pm 0.02$ dB	$\pm 0.06$ dB
Reflection tracking	$\pm 0.06$ dB	$\pm 0.06$ dB

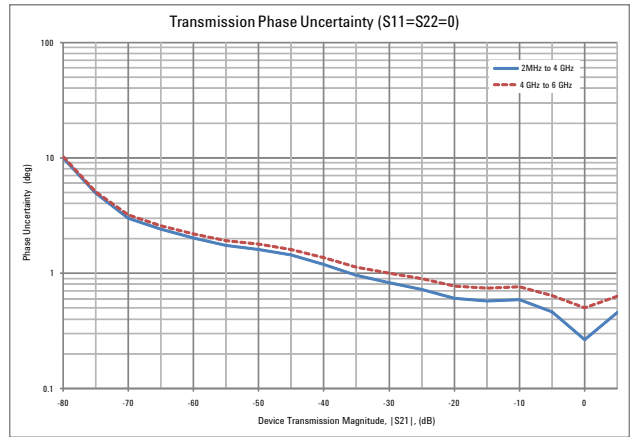
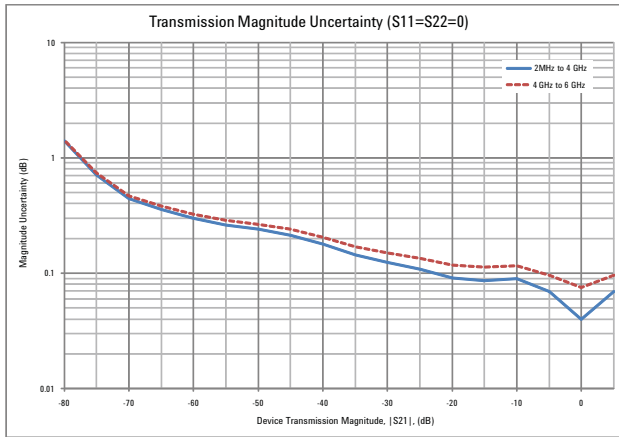

Figure 1: Transmission uncertainty (specification)

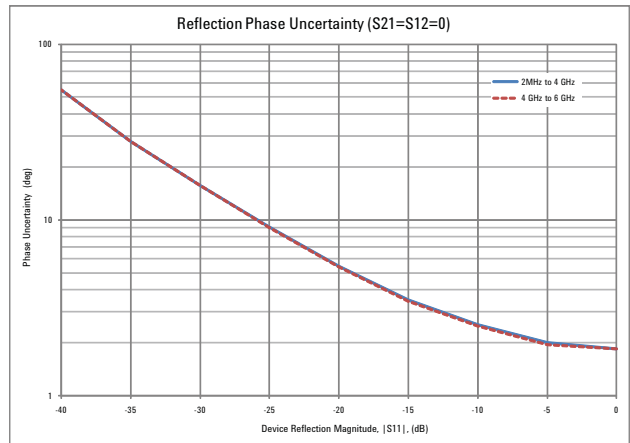
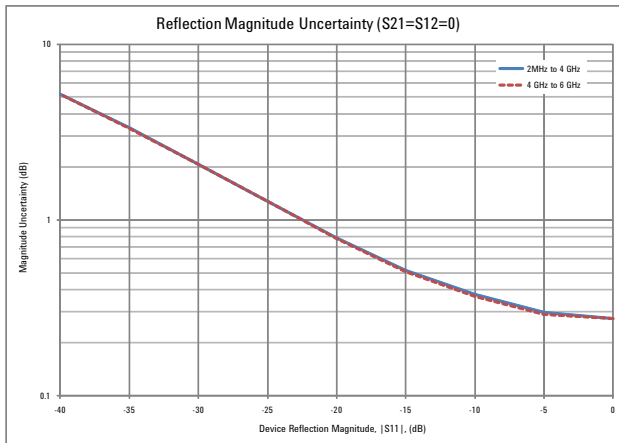

Figure 2: Reflection uncertainty (specification)

## Corrected measurement uncertainty, 2-port or enhanced response cal, low port power

Applies to N9923A, N9910X-800 Type-N (m) calibration kit, full 2-port or enhanced response calibration, IF bandwidth = 300 Hz, no averaging, data based on low port power of -40 dBm, 2-port cal available only with option 122.

	Corrected performance 2 MHz to 4 GHz	Corrected performance >4 GHz to 6 GHz
Directivity	42 dB	42 dB
Source match	36 dB	36 dB
Load match	40 dB	38 dB
Transmission tracking	$\pm 0.02$ dB	$\pm 0.06$ dB
Reflection tracking	$\pm 0.06$ dB	$\pm 0.06$ dB

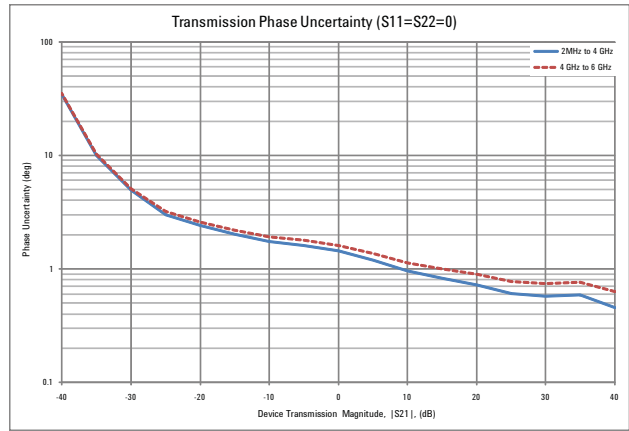
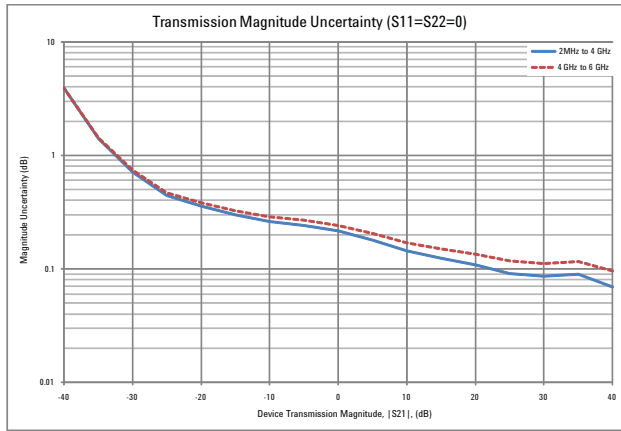

Figure 3: Transmission uncertainty (specification)

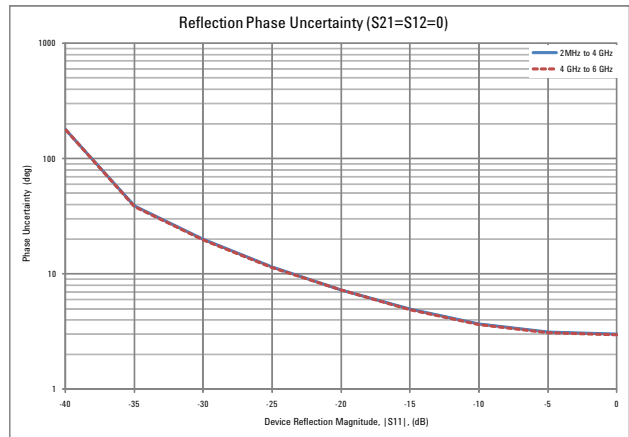
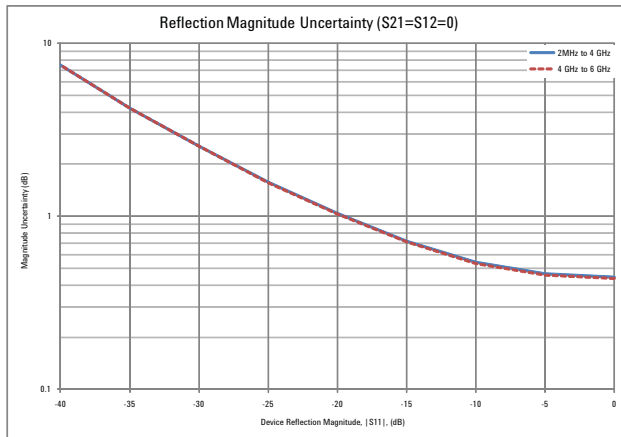

Figure 4: Reflection uncertainty (specification)

## Corrected measurement uncertainty, 1- or 2-port QuickCal, high port power (default power)

Applies to N9923A with option 112, QuickCal with load, IF bandwidth = 300 Hz, no averaging, 1-port female DUT, or 2-port female-female DUT, data based on high port power of +5 dBm , 2-port QuickCal requires option 122, typical performance.

	Corrected performance 2 MHz to 4 GHz	Corrected performance >4 GHz to 6 GHz
Directivity	38 dB	38 dB
Source match	33 dB	23 dB
Load match	37 dB	35 dB
Transmission tracking	$\pm 0.04$ dB	$\pm 0.09$ dB
Reflection tracking	$\pm 0.06$ dB	$\pm 0.06$ dB

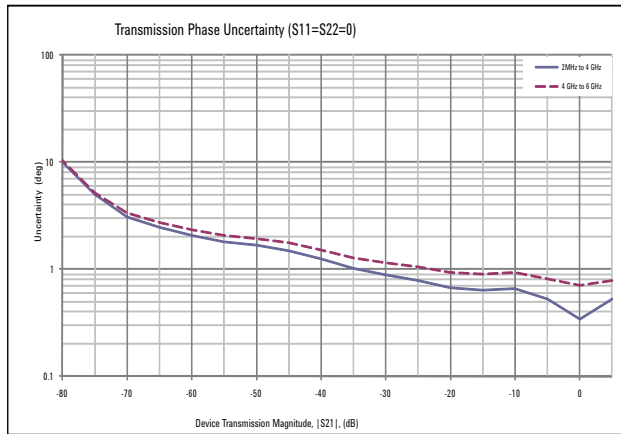
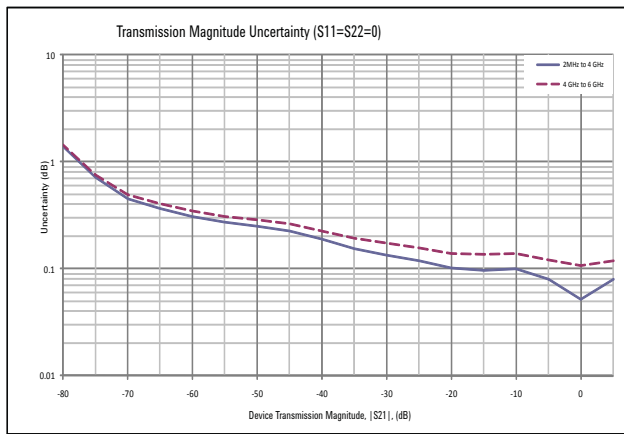

Figure 5: Transmission uncertainty

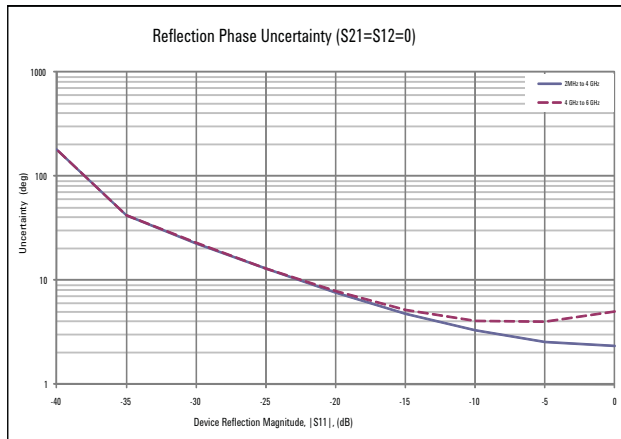
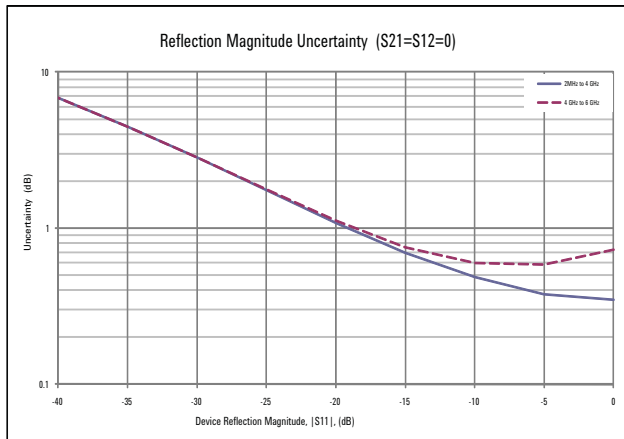

Figure 6: Reflection uncertainty



# Corrected measurement uncertainty, 1- or 2-port QuickCal, low port power

Applies to N9923A with option 112, QuickCal with load, IF bandwidth = 300 Hz, no averaging, 1-port female DUT, or 2-port female-female DUT, data based on low port power of -40 dBm, 2-port QuickCal requires option 122, typical performance.

	Corrected performance 2 MHz to 4 GHz	Corrected performance >4 GHz to 6 GHz
Directivity	38 dB	38 dB
Source match	33 dB	23 dB
Load match	37 dB	35 dB
Transmission tracking	±0.04 dB	±0.09 dB
Reflection tracking	±0.06 dB	±0.06 dB

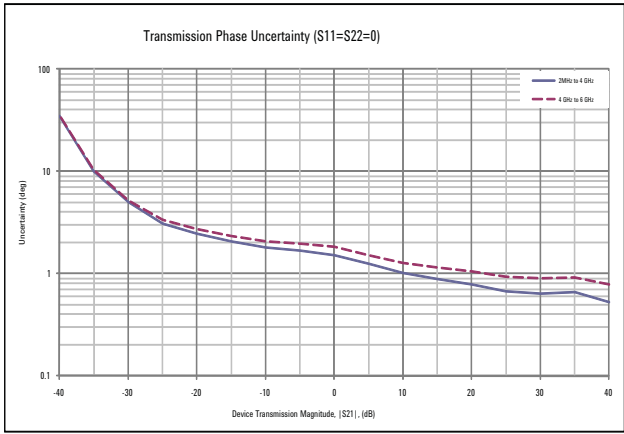
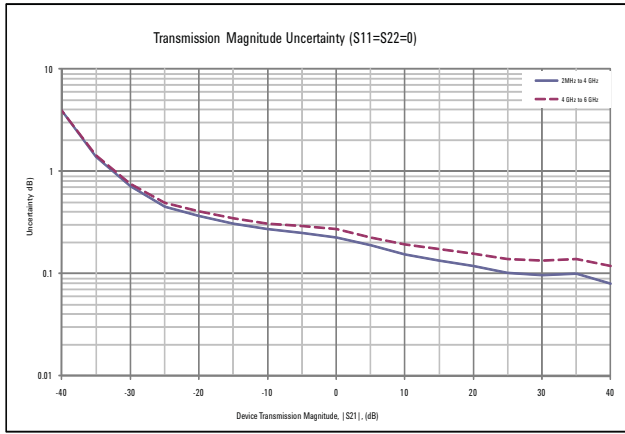

Figure 7: Transmission uncertainty

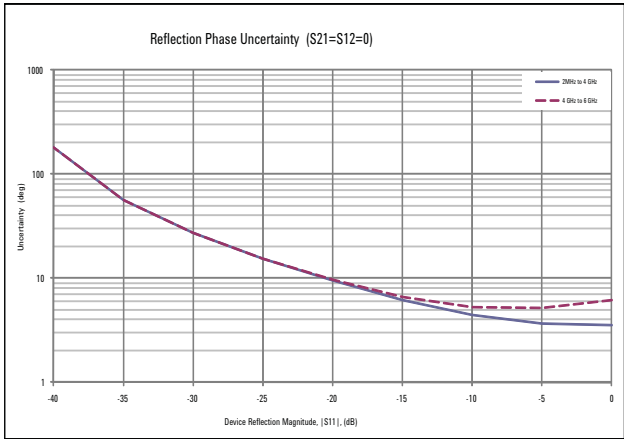
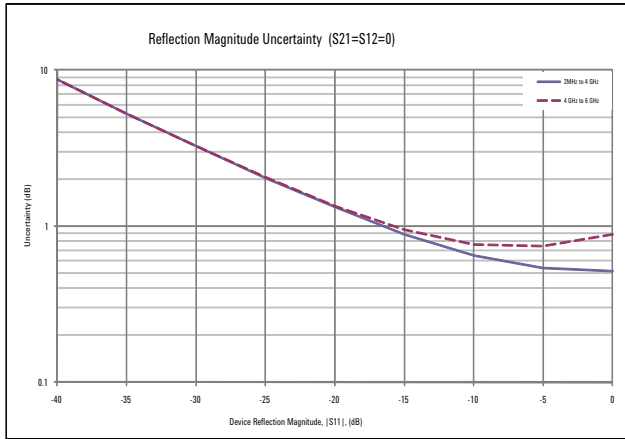

Figure 8: Reflection uncertainty

## Dynamic Accuracy

Accuracy of the test port input power, relative to the specified port power.

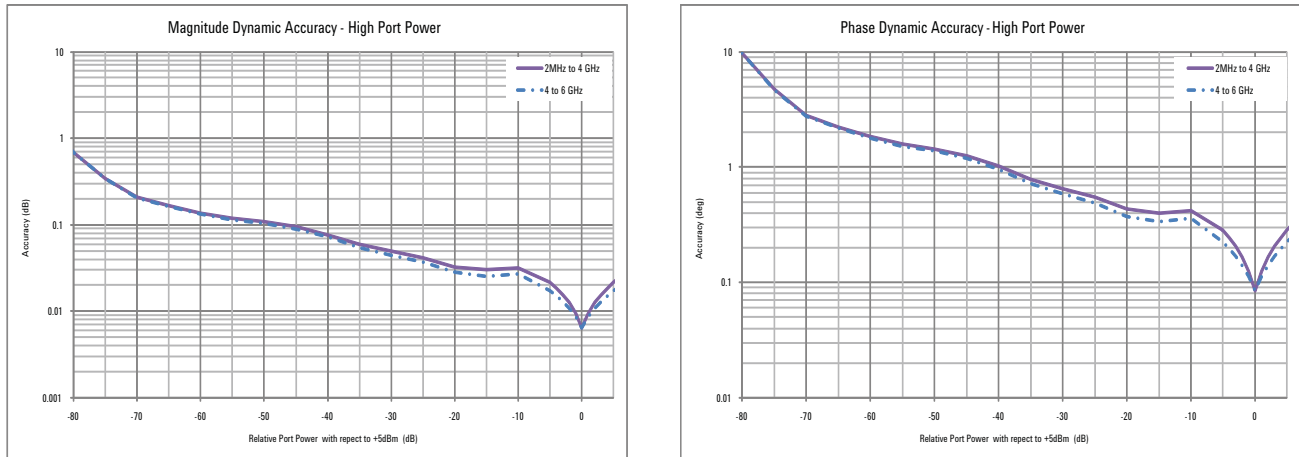

Figure 9: Dynamic accuracy (specification)

## Cable and Antenna Analyzer (option 305)

The following CAT mode performance parameters are in addition to the VNA mode performance parameters specified above.

Table1: Cable and antenna analyzer specifications

Description	Specification	Supplemental Information
<b>Cable loss</b>		
Display range	0 to 100 dB	
Resolution	0.01 dB	
<b>Distance-to-Fault</b>		
Horizontal range	Range = [(number of points – 1) / frequency span * 2] * velocity factor * speed of light	Number of points auto coupled according to start and stop distance entered
Horizontal Resolution	Resolution = Range / (number of points – 1)	Number of points settable by user
Bandpass mode Window types		Maximum, medium, and minimum windows

## External USB Power Sensor Support (option 302)

The external USB power sensor option supports the Agilent Technologies U2000 Series USB Average Power Sensors, and allows the user to make absolute power measurements. For specifications, refer to the U2000 Series USB Sensor's Data Sheet at <http://www.agilent.com/find/usbsensor>.

## Vector Voltmeter (option 308)

With vector voltmeter mode, you can characterize the difference between two measurements easily. The zeroing function allows you to create a reference signal, and characterize the difference between two device measurements.

- 1-port cable trimming - reflection or S11 measurement, magnitude and phase
- 2-port transmission - transmission or S21 measurement, magnitude and phase
- A/B and B/A - ratio of two receivers or channels, magnitude and phase – Need an external signal generator for the A/B or B/A measurement (must order option 122).

The results are shown on a large display in digital format. Refer to the network analyzer section for magnitude and phase accuracy information.

## Block Diagram

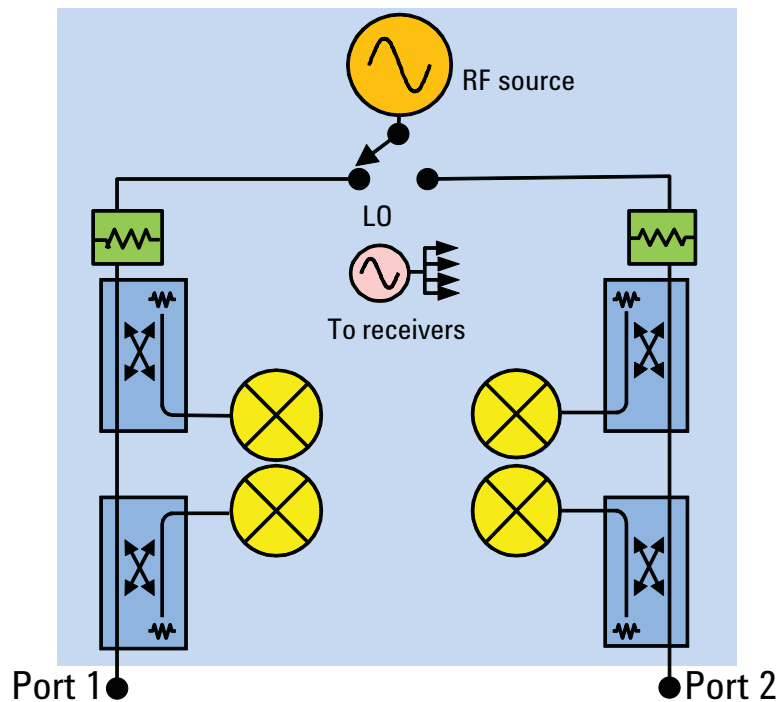

Figure 10: N9923A with option 122

## Measurement throughput

Cycle time data, 1001 points, CalRdy, typical information.

### Measurement speed

S11:1.75-3.85 GHz	1.4 ms/point
S21:1.78-2.06 GHz	1.4 ms/point

## General Information

Description	Specification	Supplemental Information
<b>Calibration cycle</b>		
	1 year	
<b>Environmental</b>		
	<ul style="list-style-type: none"> <li>Agilent Technologies outdoor equipment class<sup>1</sup></li> <li>MIL-PRF-28800F class 2</li> </ul>	
Altitude – operating	9,144 m (30,000 ft)	Under battery operation [AC to DC adapter rated at 3,000 m (9,840 ft)]
Altitude – non–operating	15,240 m (50,000 ft)	
Intrusion protection	IP 30 IEC/EN 60529	
<b>Temperature range</b>		
Operating		
AC power	–10 to 55 °C	
Battery	–10 to 50 °C	–10 to 55 °C (typical)
Storage	–51 to 71 °C	With the battery pack removed. The battery packs should be stored in an environment with low humidity. Extended exposure to temperature above 45 °C could degrade battery performance and life.
<b>EMC</b>		
Complies with European EMC Directive 2004/108/EC	<ul style="list-style-type: none"> <li>EC/EN 61326–1</li> <li>CISPR Pub 11 Group 1, class A</li> <li>AS/NZS CISPR 11</li> <li>ICES/NMB–001</li> </ul>	
<b>ESD</b>		
	• IEC/EN 61000–4–2	
<b>Safety</b>		
Complies with European Low Voltage Directive 2006/95/EC	<ul style="list-style-type: none"> <li>EC/EN 61010–1 2<sup>nd</sup> Edition</li> <li>Canada: CSA C22.2 No. 61010–1–04</li> <li>USA: UL 61010–1 2<sup>nd</sup> Edition</li> </ul>	
<b>Power</b>		
Power supply		
External DC input		40 W maximum when battery charging
External AC power adapter		Efficiency Level IV, 115 VAC
Input	100 to 250 VAC, 50 to 60 Hz 1.25 – 0.56 A	
Output	15 VDC, 4 A	
<b>Power consumption</b>		On: 14 W (typical)

1. Samples of this product have been type tested in accordance with the Agilent Environmental Test Manual (ETM) for outdoor equipment (OE) and verified to be robust against the environmental stresses of storage, transportation and end use; those stresses include but are not limited to temperature, humidity, shock, vibration, altitude and power line conditions

## General Information (continued)

Description	Specification	Supplemental Information
<b>Battery</b>		
	10.8 V, 4.6 A-h	Lithium ion
Operating time		3.5 hours (typical)
Charge time	A fully discharged battery takes about 1.5 hours to recharge to 80%, 4 hours to 100%	
Discharge temperature limits <sup>1</sup>	-10 to 60 °C, ≤ 85% RH	
Charge temperature limits <sup>1</sup>	0 to 45 °C, ≤ 85% RH	
Storage temperature limits	-20 to 50 °C <sup>1</sup> , ≤ 85% RH	The battery packs should be stored in an environment with low humidity. Extended exposure to temperature above 45 °C could degrade battery performance and life
<b>Data storage</b>		
Internal	Minimum 16 MB	Up to 1000 instrument states and trace
External		Supports USB 2.0 compatible memory devices; Supports microSD and microSDHC memory cards
<b>Display</b>	6.5" transfective color VGA LED-backlit 640 x 480 with anti-glare coating	
<b>Weight</b>	2.7 kg (6.0 lbs) including battery	
<b>Dimensions (H x W x D)</b>	292 x 188 x 72 mm (11.5" x 7.4" x 2.8")	
<b>Test ports</b>		
RF Port 1 or Port 2		
Connector	Type-N, female	
Impedance	50 Ω (nominal)	
Damage level	> +23 dBm, > ±50 VDC	

1. Charge and discharge temperatures are internal temperatures of the battery as measured by a sensor embedded in the battery. The Battery screen displays temperature information. To access the screen, select **System**, **Service Diagnostics** and **Battery**

## General Information (continued)

Description	Specification	Supplemental Information
<b>Headphone Jack Connector</b>	3.5 mm (1/8 inch) miniature audio jack	
<b>USB</b>		
USB-A (2 ports)	Hi-speed USB 2.0	
Mini USB (1 port)	Hi-speed USB 2.0	Provided for future use.
<b>LAN</b>		
External	RJ-45 connector	Up to 1000 instrument states and trace 10Base-T is NOT supported
<b>Programming</b>	The built-in LAN interface and firmware, support data transfer and control via direct connection to a LAN network.	
<b>External Reference /Trigger Input</b>		
Connector	BNC female	
External reference		
Input frequency	10 MHz	
Input amplitude range	-5 dBm to +10 dBm (nominal)	
Impedance	50 Ω (nominal)	
Lock Range	±10 ppm of external reference frequency (nominal)	
Trigger Input		
Impedance	10 KΩ (nominal)	
Level Range		
Rising Edge	1.7 V (nominal)	
Falling Edge	1 V (nominal)	

## N9923A FieldFox RF VNA Options

Must select 104 or 106 as a minimum. 104 and 106 are mutually exclusive.

N9923A-104	4 GHz RF vector network analyzer, transmission/reflection: Includes S11 and S21, mag and phase, one-port and enhanced response calibration, 2 MHz to 4 GHz.
N9923A-106	6 GHz RF vector network analyzer, transmission/reflection: Includes S11 and S21, mag and phase, one-port and enhanced response calibration, 2 MHz to 6 GHz.
N9923A-112	QuickCal: Adds one-port QuickCal and two-port QuickCal (two-port QuickCal only if option 122 is ordered).
N9923A-122	Full two-port S-parameters: Adds S12, S22, and full two-port calibration.
N9923A-302	External USB power sensor support: Enables USB port to be used for power measurements. Power sensor not included.
N9923A-305	Cable and antenna analyzer: Adds Cable and Antenna Test (CAT) mode, which allows for DTF measurements. Measurements include DTF (dB), RL & DTF, RL (dB), VSWR, DTF (VSWR), Cable loss (1-port), Insertion loss (2-port), and DTF (linear).
N9923A-308	Vector voltmeter: Provides 1-port cable trimming and 2-port transmission measurements.

## N9923A Upgrade Options

**Agilent FieldFox Customer Support** <http://na.tm.agilent.com/fieldfox>

- N9923AU-122 Add full two-port S-parameter capability to an N9923A.
- N9923AU-112 Add QuickCal capability to an N9923A.
- N9923AU-305 Add cable and antenna analysis to an N9923A.
- N9923AU-302 Add external USB power sensor support to an N9923A. Power sensor not included.
- N9923AU-308 Add vector voltmeter capability to an N9923A.

## Calibration Kits

The following is a list of the calibration kits that are loaded in a standard FieldFox. Users can add additional calibration kits to their unit using FieldFox Data Link Software. Note regarding QuickCal: The basic QuickCal, either 1 or 2-port does not require any standards. For higher accuracy, users can perform QuickCal with a load.

- N9910X-800 T-calibration kit, DC-6 GHz, Type-N(m)
- N9910X-801 T-calibration kit, DC-6 GHz, Type-N(f)
- N9910X-802 T-calibration kit, DC-6 GHz, 7/16 DIN(m)
- N9910X-803 T-calibration kit, DC-6 GHz, 7/16 DIN(f)
- 85031B Economy calibration kit, DC to 6 GHz, 7 mm
- 85032E Economy calibration kit, DC to 6 GHz, Type-N, 50-ohm
- 85032F Standard calibration kit, DC to 9 GHz, Type-N, 50-ohm
- 85033E Standard calibration kit, DC to 9 GHz, 3.5 mm
- 85036B Standard calibration kit, DC to 3 GHz, Type-N 75-ohm
- 85036E Economy calibration kit, DC to 3 GHz, Type-N 75-ohm
- 85038A Standard calibration kit, DC to 7.5 GHz, 7-16
- 85039B Economy calibration kit, DC to 3 GHz, Type-F, 75-ohm
- 85052D Economy calibration kit, DC to 26.5 GHz, 3.5 mm
- 85054B Standard calibration kit, DC to 18 GHz, Type-N, 50-ohm
- 85054D Economy calibration kit, DC to 18 GHz, Type-N, 50-ohm