

B3F

Miniature, Space-saving Switch



- Long mechanical / electrical service life
- Ideal for applications such as audio, office and communications equipment, TVs, etc
- Taped radial, vertical, high-force, and gold-plated contact type models available
- Flux-tight base structure allows easy soldering onto a PC board

Part	Rated Resistive Load - Switch	Actuator types	Contact form	Operating Force	Seal type	Termination Style	Service Life - Electrical (Min. @ Rated Loads)
B3F-1000	1 to 50 mA, 5 to 24 VDC	Top Actuated	SPST-NO	100g	Unsealed	Through-Hole PCB - Straight	1,000,000 ops.
B3F-1002	1 to 50 mA, 5 to 24 VDC	Top Actuated	SPST-NO	150g	Unsealed	Through-Hole PCB - Straight	300,000 ops
B3F-1005	1 to 50 mA, 5 to 24 VDC	Top Actuated	SPST-NO	260g	Unsealed	Through-Hole PCB - Straight	100,000 ops
B3F-1020	1 to 50 mA, 5 to 24 VDC	Raised Actuator	SPST-NO	100g	Unsealed	Through-Hole PCB - Straight	1,000,000 ops
B3F-1022	1 to 50 mA, 5 to 24 VDC	Raised Actuator	SPST-NO	150g	Unsealed	Through-Hole PCB - Straight	300,000 ops
B3F-1025	1 to 50 mA, 5 to 24 VDC	Raised Actuator	SPST-NO	260g	Unsealed	Through-Hole PCB - Straight	100,000 ops
B3F-1050	1 to 50 mA, 5 to 24 VDC	Top Actuated, projected plunger (for B32 Keycap)	SPST-NO	100g	Unsealed	Through-Hole PCB - Straight	1,000,000 ops
B3F-1052	1 to 50 mA, 5 to 24 VDC	Top Actuated, projected plunger (for B32 Keycap)	SPST-NO	150g	Unsealed	Through-Hole PCB - Straight	300,000 ops
B3F-1055	1 to 50 mA, 5 to 24 VDC	Top Actuated, projected	SPST-NO	260g	Unsealed	Through-Hole PCB - Straight	100,000 ops

Part	Rated Resistive Load - Switch	Actuator types	Contact form	Operating Force	Seal type	Termination Style	Service Life - Electrical (Min. @ Rated Loads)
B3F-5150	1 to 50 mA, 5 to 24 VDC	Top Actuated, projected plunger (for B32 Keycap)	SPST-NO	130g	Unsealed	Through-Hole PCB, w/Ground	10,000,000 ops
B3F-6000	1 to 50 mA, 5 to 24 VDC	Top Actuated	SPST-NO	100g	Unsealed	Through-Hole PCB - Straight	1,000,000 ops
B3F-6002	1 to 50 mA, 5 to 24 VDC	Top Actuated	SPST-NO	150g	Unsealed	Through-Hole PCB - Straight	300,000 ops
B3F-6020	1 to 50 mA, 5 to 24 VDC	Raised Actuator	SPST-NO	100g	Unsealed	Through-Hole PCB - Straight	1,000,000 ops
B3F-6022	1 to 50 mA, 5 to 24 VDC	Raised Actuator	SPST-NO	150g	Unsealed	Through-Hole PCB - Straight	300,000 ops
B3F-6050	1 to 50 mA, 5 to 24 VDC	Raised Actuator	SPST-NO	100g	Unsealed	Through-Hole PCB - Straight	1,000,000 ops
B3F-6052	1 to 50 mA, 5 to 24 VDC	Raised Actuator	SPST-NO	150g	Unsealed	Through-Hole PCB - Straight	300,000 ops
B3F-6120	1 to 50 mA, 5 to 24 VDC	Raised Actuator	SPST-NO	100g	Unsealed	Through-Hole PCB, w/Ground	1,000,000 ops
B3F-6100	1 to 50 mA, 5 to 24 VDC	Top Actuated	SPST-NO	100g	Unsealed	Through-Hole PCB, w/Ground	1,000,000 ops
B3F-6150	1 to 50 mA, 5 to 24 VDC	Top Actuated, projected plunger (for B32 Keycap)	SPST-NO	100g	Unsealed	Through-Hole PCB, w/Ground	1,000,000 ops
B3F-6152	1 to 50 mA, 5 to 24 VDC	Top Actuated, projected plunger (for B32 Keycap)	SPST-NO	150g	Unsealed	Through-Hole PCB, w/Ground	300,000 ops
B3F-6102	1 to 50 mA, 5 to 24 VDC	Top Actuated	SPST-NO	150g	Unsealed	Through-Hole PCB, w/Ground	300,000 ops
B3F-1002-G	100uA to 50 mA, 5 to 24 VDC	Top Actuated	SPST-NO	176g	Unsealed	Through-Hole PCB - Straight	300,000 ops
B3F-1102-G	100uA to 50 mA, 5 to 24 VDC	Top Actuated	SPST-NO	176g	Unsealed	Through-Hole PCB, w/Ground	300,000 ops
B3F-1022-G	100uA to 50 mA, 5	Raised Actuator	SPST-NO	176g	Unsealed	Through-Hole PCB -	300,000 ops

Tactile Switch B3F

Miniature, Space-Saving Tactile Switch Provides Long Service Life and Easy Mounting



- Extended mechanical/electrical service life: 10×10^6 operations for 12 x 12 mm type and 1×10^6 operations for the 6 x 6 mm type
- Ideal for applications such as audio, office and communications equipment, measuring instruments, TVs, VCRs, etc.
- Taped radial type, vertical type and high force types are available as series versions
- Flux-tight base structure allows automatic soldering of the tactile switches onto a PC board
- Gold plated models available for increased contact reliability, resistance to corrosive gas and insulation fault prevention for ion migration in harsh environments
- RoHS Compliant



Ordering Information

■ B3F-1□□□□, B3F-3□□□□

6 x 6 mm type

Type	Plunger	Switch height x pitch	Operating force	Model	
				Without ground terminal	With ground terminal
				Bags	Bags
Standard		4.3 x 6.5 mm	General-purpose: 100 g	B3F-1000	B3F-1100
			150 g	B3F-1002	B3F-1102
			High-force: 260 g	B3F-1005	B3F-1105
		5.0 x 6.5 mm	General-purpose: 100 g	B3F-1020	B3F-1120
			150 g	B3F-1022	B3F-1122
			High-force: 260 g	B3F-1025	B3F-1125
	5.0 x 7.5 mm	General-purpose: 100 g	—	B3F-1110	
		7.3 x 6.5 mm	General-purpose: 100 g	B3F-1050	B3F-1150
			150 g	B3F-1052	B3F-1152
High-force: 260 g	B3F-1055	B3F-1155			
Vertical		3.15 mm	General-purpose: 100 g	—	B3F-3100
			150 g	—	B3F-3102
			High-force: 260 g	—	B3F-3105
		3.85 mm	General-purpose: 100 g	—	B3F-3120
			150 g	—	B3F-3122
			High-force: 260 g	—	B3F-3125
	6.15 mm		General-purpose: 100 g	—	B3F-3150
			150 g	—	B3F-3152
		High-force: 260 g	—	B3F-3155	

Important Note: Switches cannot be water-washed.

■ B3F-1□□□-G







6 x 6 mm type with Gold Plating

Type	Plunger	Switch height x pitch	Form of shipment operating force	Model	
				Without ground terminal	With ground terminal
Bags (100 Switches)					
6 x 6 mm switches with gold plating		4.3 x 6.5 mm	176 g	B3F-1002-G	B3F-1102-G
		5.0 x 6.5 mm		B3F-1022-G	B3F-1122-G

Note: The minimum order is 100 Switches. Order in multiples of the minimum order.

■ B3F-4□□□, B3F-5□□□



12 x 12 mm type

Type	Plunger	Switch height x pitch	Operating force	Model	
				Without ground terminal	With ground terminal
Bags					
Standard		4.3 x 12.5 mm	General-purpose: 130 g	B3F-4000	B3F-4100
			High-force: 260 g	B3F-4005	B3F-4105
		7.3 x 12.5 mm	General-purpose: 130 g	B3F-4050	B3F-4150
			High-force: 260 g	B3F-4055	B3F-4155
Long service life		4.3 x 12.5 mm	General-purpose: 130 g	B3F-5000	B3F-5100
		7.3 x 12.5 mm		B3F-5050	B3F-5150
High reliability gold-plated contact		4.3 x 12.5 mm		B3F-5001	B3F-5101
		7.3 x 12.5 mm		B3F-5051	B3F-5151

Important Note: Switches cannot be water-washed.

■ B3F-6□□□

**Taped Radial (Auto Insertion)
6 x 6 mm type**

Type	Plunger	Switch height x pitch	Operating force	Model	
				Without ground terminal	With ground terminal
B3F-6000	Flat 	4.3 x 6.5 mm	General-purpose: 100 g	B3F-6000	B3F-6100
			High-force: 150 g	B3F-6002	B3F-6102
		5.0 x 6.5 mm	General-purpose: 100 g	B3F-6020	B3F-6120
			High-force: 150 g	B3F-6022	B3F-6122
	Projected 	7.3 x 6.5 mm	General-purpose: 100 g	B3F-6050	B3F-6150
			High-force: 150 g	B3F-6052	B3F-6152

Note: The above switches must be ordered in units of 1,000.

Important Note: Switches cannot be water-washed.

■ **Accessories**

See “B32” Tactile Switch Key Top data sheet for keycaps that fit projected plunger B3F models.

■ **Plunger Identification Table**

Use this table to determine tactile switch type by plunger color.

Plunger color	Operating force	Type
Light gray	100 g	B3F-1000, 1150, 3100, 6000, 6050
White	100 g	B3F-1050, 1100, 3150, 4000, 4050, 4100
Black	100 g	B3F-1020, 1110, 1120, 3120, 6020, 6120
Blue	130 g	B3F-5000 Series
Yellow	150 g	B3F-1002, 1052, 1102, 3102, 3152, 4005, 4055, 4105, 4155, 6002, 6052
Medium gray	150 g	B3F-1022, 1122, 3122, 6022
Orange	260 g	B3F-1005, 1055, 1105, 3105, 6005, 6055
Pink	260 g	B3F-1025, 1125, 3125, 6025

Specifications

■ Characteristics

	Part Number				
	B3F-1□□□ B3F-3□□□	B3F-4□□□	B3F-5□□□	B3F-6□□□	B3F-1□□□-G
Weight (see note 2)	Approx. 0.25 g	Approx. 0.85 g		Approx. 0.25 g	
Contact form	SPST-NO				SPST-NO
Switching capacity	1 to 50 mA, 5 to 24 VDC (resistive load)				100 μA to 50 mA, 5 to 24 VDC (resistive load)
Contact resistance	100 MΩ max. (Initial Value, Rated: 1mA, 5VDC)				100 MΩ max. (initial value) (rated: 100 μA, 5 VDC)
Insulation resistance	100 MΩ min. (at 250 VDC)				
Dielectric strength	500 VAC, 50/60 Hz for 1 minute				
Bounce time	5 ms max.				
Vibration	Malfunction durability: 10 to 55 Hz, 1.5 mm double amplitude				Malfunction: 10 to 55 Hz, 1.5 mm double amplitude for 30 to 60 s
Shock	Mechanical durability: 1,000 m/s ² (approx. 100 G) Malfunction durability: 100 m/s ² (approx. 10 G)				Destruction: 1,000 m/s ² max.
Ambient temperature	-25° to 70°C (with no icing)				
Humidity	35% to 85% RH				35% to 85%

1. Denotes the weight of standard type.
2. Data shown are of initial value.

■ Life Expectancy

B3F-1000, B3F-3000, B3F-6000:
1,000,000 operations min (OF: 100gf) (B3F-1070: 500,000 operations min)
300,000 operations min (OF: 150 gf)
100,000 operations min (OF: 260gf)
B3F-G:
300,000 operations min (OF: 176gf)
B3F-4000:
3,000,000 operations min (OF: 1.28 N)
1,000,000 operations min (OF: 2.55 N)
B3F-5000:
10,000,000 operations min.

■ Operating Characteristics

Characteristics	Part Number						
	B3F-1□□□ / -3□□□		B3F-4□□□ / -5□□□		B3F-6□□□		B3F-1□□□-G
	General purpose type	High force type	General purpose type	High force type	General purpose type	High force type	General purpose type
Operating force (OF)	100 ± 30 g	150 ± 50 g	130 ± 50 g	260 ± 70 g	100 ± 30 g	150 ± 50 g	1.76 ± 0.49 N
Release force (RF) min.	20 g	50 g	30 g	50 g	20 g	50 g	0.49 N
Pretravel (PT) max.	0.25 ^{+0.2} / _{-0.1} mm	0.25 ^{+0.2} / _{-0.1} mm	0.3 ^{+0.2} / _{-0.1} mm	0.3 ^{+0.2} / _{-0.1} mm	0.25 ^{+0.2} / _{-0.1} mm	0.25 ^{+0.2} / _{-0.1} mm	0.25 ^{+0.2} / _{-0.1} mm

Construction

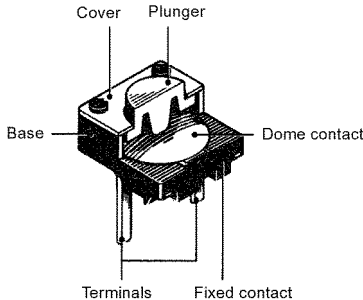

B3F-1□□□-G

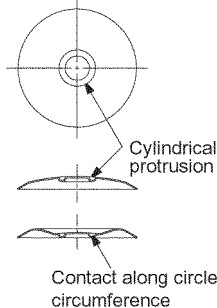

Contact along circle circumference (circular contact)

Switches have circular contact surface instead of single center point contact, increasing contact reliability.

Contact Form

B3F-10□□
 -40□□
 -50□□
 -10□□-G

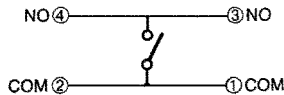

B3F-11□□
 -41□□
 -51□□
 -11□□-G

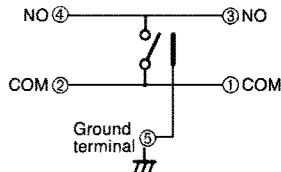

B3F-3□□□

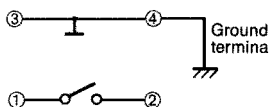

Engineering Data

Operating Force vs. Stroke (typical example)

B3F-1□□□/-3□□□/-6□□□

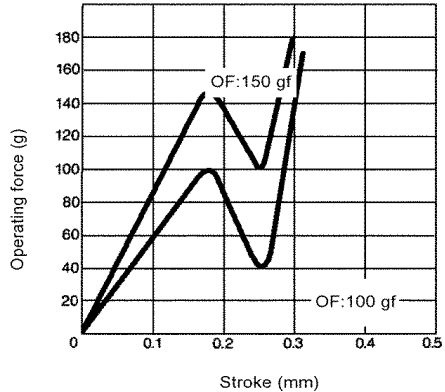

B3F-4□□□/-5□□□

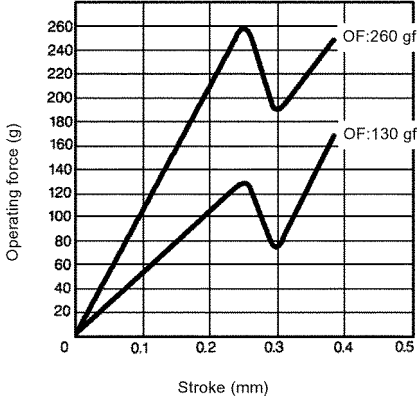

■ B3F-4101/-5100/-4105/-5101

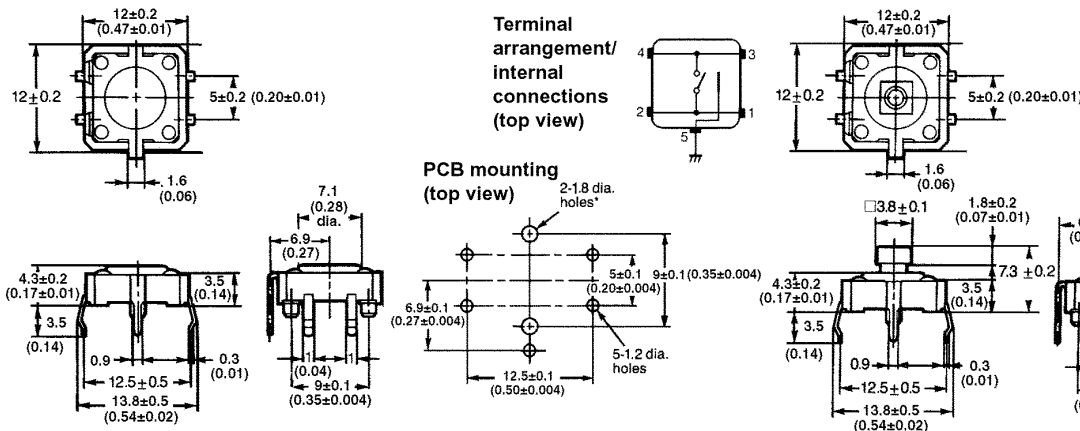

■ B3F-4150/-5150/-4155/-5151

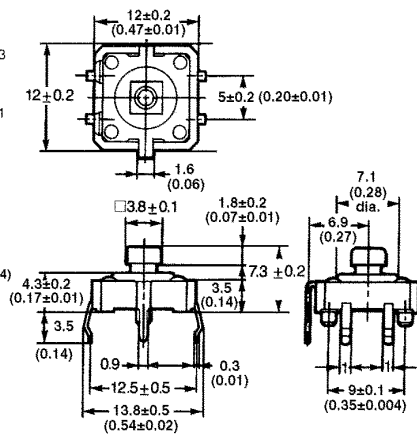

* Fit the projection of the switch into this hole to secure the switch.

■ B3F-6000/-6002

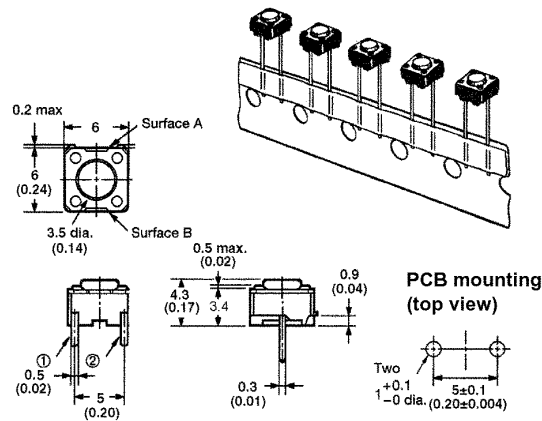

■ Tape-Packaging Dimensions

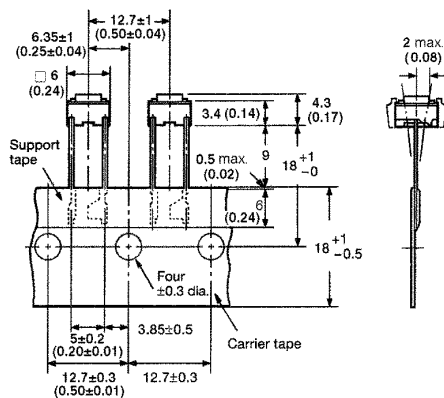

Note: The tape is random between surface A and surface B.

Unit: mm (inch)

■ B3F-6100/-6102

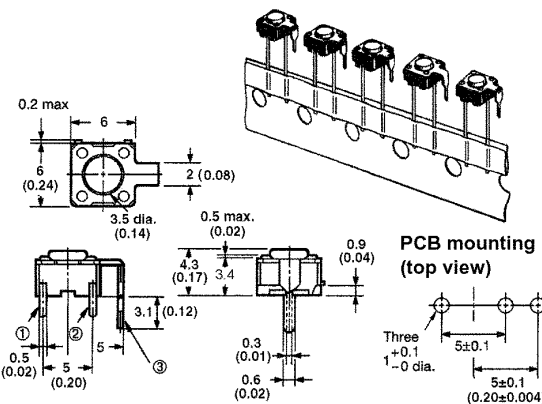

■ Tape-Packaging Dimensions

