

SS



Subminiature Snap Action Switch

- Two split spring design offers long life (30 million operations)
- wide variety of operating forces, including super low force
- Solder, quick-connect (#110) and PCB terminals available
- UL, CSA, VDE approvals
- microvoltage to high-capacity loads(10.1 A) versions
- ROHS Compliant

Part	Rated Resistive Load - Switch	Actuator types	Contact form	Operating Force	Seal type	Termination Style	Service Life - Electrical (Min. @ Rated Loads)
SS-01	0.1A @ 125VAC/0.1A @ 30VDC	Pin plunger	SPDT	150g	Unsealed	Solder	200,000 ops
SS-01D	0.1A @ 125VAC/0.1A @ 30VDC	Pin plunger	SPDT	150g	Unsealed	Through-Hole PCB - Straight	200,000 ops
SS-01D1	0.1A @ 125VAC/0.1A @ 30VDC	Pin plunger	SPDT	150g	Unsealed	Through-Hole PCB - parallel left	200,000 ops
SS-01D2	0.1A @ 125VAC/0.1A @ 30VDC	Pin plunger	SPDT	150g	Unsealed	Through-Hole PCB - parallel right	200,000 ops
SS-01T	0.1A @ 125VAC/0.1A @ 30VDC	Pin plunger	SPDT	150g	Unsealed	110 Quick Connect	200,000 ops
SS-01-E	0.1A @ 125VAC/0.1A @ 30VDC	Pin plunger	SPDT	25g	Unsealed	Solder	200,000 ops
SS-01-ED	0.1A @ 125VAC/0.1A @ 30VDC	Pin plunger	SPDT	25g	Unsealed	Through-Hole PCB - Straight	200,000 ops
SS-01-ET	0.1A @ 125VAC/0.1A @ 30VDC	Pin plunger	SPDT	25g	Unsealed	110 Quick Connect	200,000 ops
SS-01-F	0.1A @ 125VAC/0.1A @ 30VDC	Pin plunger	SPDT	50g	Unsealed	Solder	200,000 ops
SS-01-FD	0.1A @ 125VAC/0.1A @ 30VDC	Pin plunger	SPDT	50g	Unsealed	Through-Hole PCB - Straight	200,000 ops

Part	Rated Resistive Load - Switch	Actuator types	Contact form	Operating Force	Seal type	Termination Style	Service Life - Electrical (Min. @ Rated Loads)
SS-5GL-FD2	5A @ 125VAC/4A @ 30VDC	Hinge lever	SPDT	16g	Unsealed	Through-Hole PCB - parallel right	200,000 ops
SS-5GL-FT	5A @ 125VAC/4A @ 30VDC	Hinge lever	SPDT	16g	Unsealed	110 Quick Connect	200,000 ops
SS-5GL13	5A @ 125VAC/4A @ 30VDC	Simulated roller lever	SPDT	50g	Unsealed	Solder	200,000 ops
SS-5GL13D	5A @ 125VAC/4A @ 30VDC	Simulated roller lever	SPDT	50g	Unsealed	Through-Hole PCB - Straight	200,000 ops
SS-5GL13D1	5A @ 125VAC/4A @ 30VDC	Simulated roller lever	SPDT	50g	Unsealed	Through-Hole PCB - parallel left	200,000 ops
SS-5GL13D2	5A @ 125VAC/4A @ 30VDC	Simulated roller lever	SPDT	50g	Unsealed	Through-Hole PCB - parallel right	200,000 ops
SS-5GL13T	5A @ 125VAC/4A @ 30VDC	Simulated roller lever	SPDT	50g	Unsealed	110 Quick Connect	200,000 ops
SS-5GL13-F	5A @ 125VAC/4A @ 30VDC	Simulated roller lever	SPDT	16g	Unsealed	Solder	200,000 ops
SS-5GL13-FD	5A @ 125VAC/4A @ 30VDC	Simulated roller lever	SPDT	16g	Unsealed	Through-Hole PCB - Straight	200,000 ops
SS-5GL13-FD2	5A @ 125VAC/4A @ 30VDC	Simulated roller lever	SPDT	16g	Unsealed	Through-Hole PCB - parallel right	200,000 ops
SS-5GL13-FT	5A @ 125VAC/4A @ 30VDC	Simulated roller lever	SPDT	16g	Unsealed	110 Quick Connect	200,000 ops
SS-5GL14	5A @ 125VAC/4A @ 30VDC	Formed hinge lever	SPDT	50g	Unsealed	Solder	200,000 ops
SS-5GL14D	5A @ 125VAC/4A @ 30VDC	Formed hinge lever	SPDT	50g	Unsealed	Through-Hole PCB - Straight	200,000 ops
SS-5GL14T	5A @ 125VAC/4A @ 30VDC	Formed hinge lever	SPDT	50g	Unsealed	110 Quick Connect	200,000 ops
SS-5GL14-F	5A @ 125VAC/4A @ 30VDC	Formed hinge lever	SPDT	16g	Unsealed	Solder	200,000 ops
SS-5GL2	5A @ 125VAC/4A @ 30VDC	Hinge roller lever	SPDT	50g	Unsealed	Solder	200,000 ops
SS-	5A @	Hinge	SPDT	50g	Unsealed	Through-	200,000

Snap Action Switch SS

Subminiature Snap Action Switch



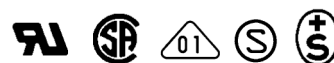

- Economical, subminiature snap action switch offers long service life (30 million operations minimum)
- All models are free from overtravel restrictions, permit easy setting
- Wide switching capacity range from microvoltage/current loads (1 mA at 5 VDC to high-capacity loads 10.1 A at 250 VAC)
- Standard operating force, low force or super-low force models available
- RoHS Compliant



Ordering Information

■ Standard Type

Microvoltage/microcurrent load 0.1 A max. (Bifurcated crossbar contacts)

Actuator	Contact OF	Model				
		PCB terminal			Soldered terminal	Tab (#110) terminal
		Straight vertical	Parallel to left	Parallel to right		
Pin plunger 	25 g	SS-01-ED	—	—	SS-01-E	SS-01-ET
	50 g	SS-01-FD	—	—	SS-01-F	SS-01-FT
	150 g	SS-01D	SS-01D1	SS-01D2	SS-01	SS-01T
Hinge lever 	8 g	SS-01GL-ED	—	—	SS-01GL-E	SS-01GL-ET
	16 g	SS-01GL-FD	—	—	SS-01GL-F	SS-01GL-FT
	50 g	SS-01GLD	SS-01GLD1	SS-01GLD2	SS-01GL	SS-01GLT
Simulated roller lever 	8 g	SS-01GL13-ED	—	—	SS-01GL13-E	SS-01GL13-ET
	16 g	SS-01GL13-FD	—	—	SS-01GL13-F	SS-01GL13-FT
	50 g	SS-01GL13D	—	—	SS-01GL13	SS-01GL13T
Formed hinge lever 	8 g	—	—	—	SS-01GL14-E	SS-01GL14-ET
	16 g	SS-01GL14-FD	—	—	SS-01GL14-F	—
	50 g	SS-01GL14D	—	—	SS-01GL14	SS-01GL14T
Hinged roller lever 	8 g	SS-01GL2-ED	—	—	SS-01GL2-E	SS-01GL2-ET
	16 g	SS-01GL2-FD	—	—	SS-01GL2-F	SS-01GL2-FT
	50 g	SS-01GL2D	—	—	SS-01GL2	SS-01GL2T

■ General-Purpose

5 A max. (Standard rivet contacts)

Actuator	Contact OF	Model				
		PCB terminal			Soldered terminal	Tab (#110) terminal
		Straight vertical	Parallel to left	Parallel to right		
Pin plunger	50 g	SS-5-FD	SS-5-FD1	SS-5-FD2	SS-5-F	SS-5-FT
	150 g	SS-5D	SS-5D1	SS-5D2	SS-5	SS-5T
Hinge lever	16 g	SS-5GL-FD	SS-5GL-FD1	SS-5GL-FD2	SS-5GL-F	SS-5GL-FT
	50 g	SS-5GLD	SS-5GLD1	SS-5GLD2	SS-5GL	SS-5GLT
Simulated roller lever	16 g	SS-5GL13-FD	—	SS-5GL13-FD2	SS-5GL13-F	SS-5GL13-FT
	50 g	SS-5GL13D	SS-5GL13D1	SS-5GL13D2	SS-5GL13	SS-5GL13T
Formed hinge lever	16 g	SS-5GL14-FD	SS-5GL14-FD1	—	SS-5GL14-F	SS-5GL14-FT
	50 g	SS-5GL14D	SS-5GL14D1	SS-5GL14D2	SS-5GL14	SS-5GL14T
Hinge roller lever	16 g	SS-5GL2-FD	SS-5GL2-FD1	SS-5GL2-FD2	SS-5GL2-F	SS-5GL2-FT
	50 g	SS-5GL2D	SS-5GL2D1	SS-5GL2D2	SS-5GL2	SS-5GL2T

10.1 A max. (Standard rivet contacts)

Actuator	Contact OF	Model				
		PCB terminal			Soldered terminal	Tab (#110) terminal
		Straight vertical	Parallel to left	Parallel to right		
Pin plunger	150 g	SS-10D	—	—	SS-10	SS-10T
Hinge lever	50 g	SS-10GLD	—	—	SS-10GL	SS-10GLT
Simulated roller lever	50 g	SS-10GL13D	—	—	SS-10GL13	SS-10GL13T
Formed hinge lever	50 g	—	—	—	SS-10GL14	—
Hinge roller lever	50 g	SS-10GL2D	—	—	SS-10GL2	SS-10GL2T

Specifications

■ Characteristics

Switch type	General-purpose		
Operating speed (see note 3)	0.1 mm to 1 m/second (0.004 to 39.4 in/second)		
Operating frequency	Mechanical	400 operations per minute (pin plunger actuator type)	
	Electrical	60 operations per minute (pin plunger actuator type)	
Insulation resistance	100 MΩ at 500 VDC		
Dielectric strength	Crossbar contact type	600 VAC, 50/60 Hz for 1 minute (see note 1)	
	Others	1,000 VAC, 50/60 Hz for 1 minute between terminals of same polarity 1,500 VAC, 50/60 Hz for 1 minute between current-carrying parts and ground and between each terminal and noncurrent-carrying metal parts	
Vibration	Malfunction durability	10 to 55 Hz, 1.5 mm double amplitude	
Shock	Mechanical durability	Low-OF type: 500 m/s ² min. (approx. 50 g) Others: 1,000 m/s ² min. (approx. 100 g)	
		Malfunction durability	Standard type: 300 m/s ² min. (approx. 30 g) Low-OF type: 200 m/s ² min. (approx. 20 g) Lever type at TTP: Contact gap, 1 ms max.
	Ambient temperature		Operating
	Humidity	85% RH max.	
Service life	Mechanical	30 million operations minimum (OT: rated value) (see note 4)	
	Electrical	200,000 operations minimum (rated load) (see note 2)	
Weight	Approx. 1.6 g pin plunger type		

- Note:**
1. SS-10 series only.
 2. 50,000 operations minimum for the SS-10 series.
 3. Applies to the pin plunger type (at the pin plunger of the lever type).
 4. 10 million operations for the SS-10 series.
 5. Data shown are of initial value.

■ Operating Characteristics

Characteristics	Part number				
	SS-01-E	SS-01-F SS-5-F	SS-01 SS-5	SS-10	SS-01GL-E
OF max.	25 g	50 g	150 g	150 g	8 g
RF min.	2 g	4 g	25 g	25 g	1 g
PT max.	0.5 mm (0.020 in)	0.5 mm (0.020 in)	0.5 mm (0.020 in)	0.6 mm (0.024 in)	1.2 mm (0.047 in)
OT min.	0.5 mm (0.020 in)	0.5 mm (0.020 in)	0.5 mm (0.020 in)	0.4 mm (0.016 in)	0.8 mm (0.032 in)
MD max.	0.1 mm (0.004 in)	0.1 mm (0.004 in)	0.1 mm (0.004 in)	0.12 mm (0.005 in)	13.6 mm (0.535 in)
OP	8.4 ± 0.5 mm (0.331 ± 0.020 in)	8.4 ± 0.5 mm (0.331 ± 0.020 in)	8.4 ± 0.5 mm (0.331 ± 0.020 in)	8.4 ± 0.5 mm (0.331 ± 0.020 in)	8.8 ± 0.8 mm (0.346 ± 0.032 in)

Characteristics	Part number				
	SS-01GL-F SS-5GL-F	SS-01GL SS-5GL	SS-10GL	SS-10GL13-E	SS-10GL13-F SS-5GL13-F
OF max.	16 g	50 g	50 g	8 g	16 g
RF min.	2 g	6 g	6 g	1 g	2 g
PT max.	1.2 mm (0.047 in)	1.2 mm (0.047 in)	1.0 mm (0.039 in)	1.2 mm (0.047 in)	1.2 mm (0.047 in)
OT min.	0.8 mm (0.032 in)	0.8 mm (0.032 in)	1.0 mm (0.039 in)	0.8 mm (0.032 in)	0.8 mm (0.032 in)
MD max.	13.6 mm (0.535 in)	13.6 mm (0.535 in)	13.6 mm (0.535 in)	15.5 mm (0.610 in)	15.5 mm (0.610 in)
OP	8.8±0.8 mm (0.346±0.032 in)	8.8±0.8 mm (0.346±0.032 in)	8.8±0.8 mm (0.346±0.032 in)	10.7±0.8 mm (0.421±0.032 in)	10.7±0.8 mm (0.421±0.032 in)

Characteristics	Part number				
	SS-01GL13 SS-5GL13	SS-10GL13	SS-01GL14-E	SS-01GL14-F SS-5GL14-F	SS-01GL14 SS-5GL14
OF max.	50 g	50 g	8 g	16 g	50 g
RF min.	6 g	6 g	1 g	2 g	6 g
PT max.	1.2 mm (0.047 in)	1.0 mm (0.039 in)	1.2 mm (0.047 in)	1.2 mm (0.047 in)	1.2 mm (0.047 in)
OT min.	0.8 mm (0.032 in)	1.0 mm (0.039 in)	0.8 mm (0.032 in)	0.8 mm (0.032 in)	0.8 mm (0.032 in)
MD max.	15.5 mm (0.610 in)	15.5 mm (0.610 in)	14.9 mm (0.587 in)	14.9 mm (0.587 in)	14.9 mm (0.587 in)
OP	10.7 ± 0.8 mm (0.421 ± 0.032 in)	10.7 ± 0.8 mm (0.421 ± 0.032 in)	10.1 ± 0.8 mm (0.398 ± 0.032 in)	10.1 ± 0.8 mm (0.398 ± 0.032 in)	10.1 ± 0.8 mm (0.398 ± 0.032 in)

Characteristics	Part number				
	SS-10GL14	SS-01GL2-E	SS-01GL2-F SS-5GL2-F	SS-01GL2 SS-5GL2	SS-10GL2
OF max.	50 g	8 g	16 g	50 g	50 g
RF min.	6 g	1 g	2 g	6 g	6 g
PT max.	1.0 mm (0.039 in)	1.2 mm (0.047 in)	1.2 mm (0.047 in)	1.2 mm (0.047 in)	1.0 mm (0.039 in)
OT min.	1.0 mm (0.039 in)	0.8 mm (0.032 in)	0.8 mm (0.032 in)	0.8 mm (0.032 in)	1.0 mm (0.039 in)
MD max.	14.9 mm (0.587 in)	19.3 mm (0.760 in)	19.3 mm (0.760 in)	19.3 mm (0.760 in)	19.3 mm (0.760 in)
OP	10.1 ± 0.8 mm (0.398 ± 0.032 in)	14.5 ± 0.8 mm (0.571 ± 0.032 in)	14.5 ± 0.8 mm (0.571 ± 0.032 in)	14.5 ± 0.8 mm (0.571 ± 0.032 in)	14.5 ± 0.8 mm (0.571 ± 0.032 in)

■ Ratings

Microvoltage/microcurrent load type

Contact form	General purpose/resistive load	
	Bifurcated crossbar contacts	
	NC	NO
125 VAC	0.1 A	0.1 A
30 VDC	0.1 A	0.1 A
Inrush current	1 A max.	1 A max.

Standard type general purpose

Switch series:	Rivet contacts									
	Resistive load				Lamp load		Inductive load		Motor load	
	SS-5		SS-10		SS-5 and SS-10		SS-5 and SS-10		SS-5 and SS-10	
Contact form	NC	NO	NC	NO	NC	NO	NC	NO	NC	NO
125 VAC	5 A	5 A	10.1 A	10.1 A	1.5 A	0.7 A	3 A	3 A	2.5 A	1.3 A
250 VAC	3 A	3 A	10.1 A	10.1 A	1 A	0.5 A	2 A	2 A	1.5 A	0.8 A
8 VDC	5 A	5 A	10.1 A	10.1 A	2 A	2 A	5 A	4 A	3 A	3 A
14 VDC	5 A	5 A	10.1 A	10.1 A	2 A	2 A	4 A	4 A	3 A	3 A
30 VDC	4 A	4 A	4 A	4 A	2 A	2 A	3 A	3 A	3 A	3 A
125 VDC	0.4 A	0.4 A	0.4 A	0.4 A	0.05 A	0.05 A	0.4 A	0.4 A	0.05 A	0.05 A
250 VDC	0.2 A	0.2 A	0.2 A	0.2 A	0.03 A	0.03 A	0.2 A	0.2 A	0.03 A	0.03 A
Inrush current	20 A max. 10 A max. 20 A max. 15 A max. (both non-inductive and inductive loads)									

- Note:**
- The above current ratings are the values of the steady-state current.
 - Inductive load has a power factor of 0.4 min. (AC) and a time constant of 7 milliseconds max. (DC). The inductive load applicable to the SS-10 series must have a power factor of 0.75 min.
 - Lamp load has an inrush current of 10 times the steady-state current
 - Motor load has an inrush current of 6 times the steady-state current.
 - If the switch is used in a DC circuit and is subjected to inrush current or surge, connect a surge suppressor across the switch.

Contact Resistance (mΩ max., initial)

	SS-01□	SS-5□	SS-10□
Contact rating:	0.1 A	3 A or 5 A	10.1 A
Normal operating force models (SS-□)	50 mΩ	30 mΩ	30 mΩ
Low operating force models (SS-□-F)	100 mΩ	50 mΩ	—
Super-low operating force models (SS-□-E)	150 mΩ	—	—
Lead wire models (all OF types)	100 mΩ	50 mΩ	—

Contact Form

SPDT
(common throughout the series)

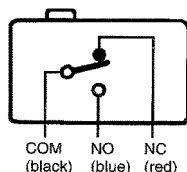

SPST-NC*
(standard models rated at 0.1 to 0.5 A)

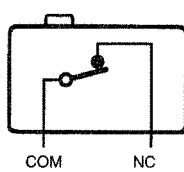

SPST-NO*
(standard models rated at 0.1 to 5 A)

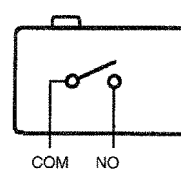

Sealed lead wire terminal models have color coded leads.

* Consult Omron for SPST-NC and SPST-NO contact form types ordering information.

Approvals

UL (File No. E41515), CSA (File No. LR21642), SS-5/SS-10: EN conforms 61058-1

Type		Rating
SS-10 series	General-purpose type	10.1 A, 250 VAC
SS-5 series	General-purpose type	5 A, 125 V, 3 A 250 VAC
SS-01 series	Super-low force type	0.1 A, 125 VAC, 30 VDC

VDE (File No. 5861-3221)

Type		Rating
SS-5 series	General-purpose type	5 A, 250 VAC

SEMKO (File Nos. 43-8614026/43-891609)

Type		Rating
SS-10 series	General-purpose type	10 A, 250 VAC
SS-5 series	General-purpose type	5 A, 250 VAC

Note: The rated values approved by each of the safety standards (e.g. UL, CSA) may be different from the performance characteristics individually defined in this catalog.

Engineering Data

Mechanical service life

Standard type (SS-5, SS-10 series)

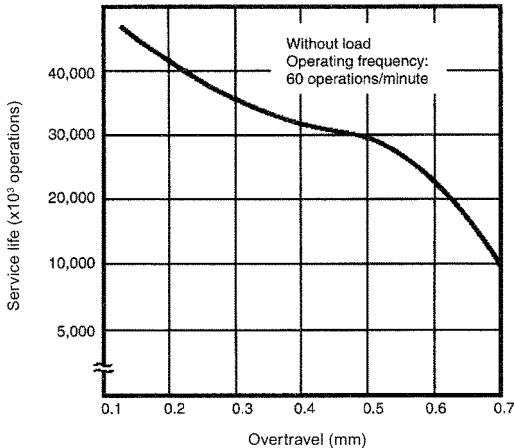

Electrical service life

Standard type (SS-5 series)

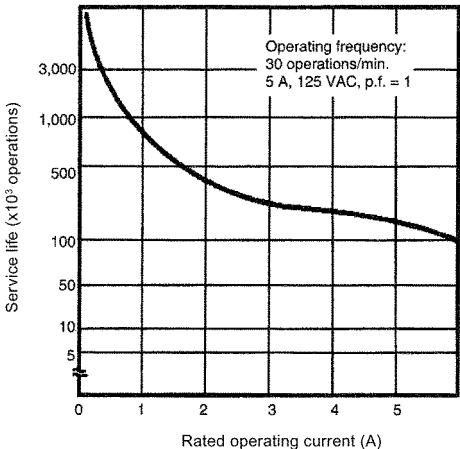

Dimensions

Unit: mm (inch)

Pin Plunger

- SS-01 (-E, -F)
- SS-5 (-F)
- SS-10

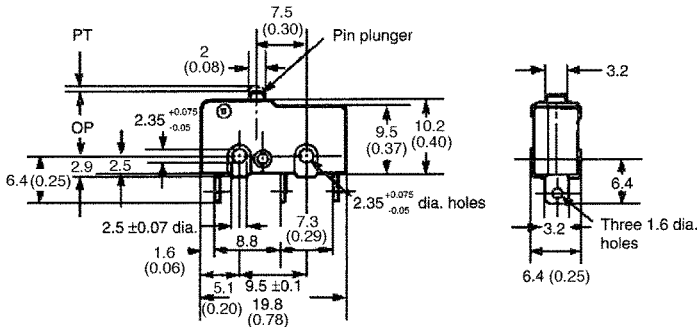

Hinge Lever

- SS-01GL (-E, -F)
- SS-5GL (-F)
- SS-10GL

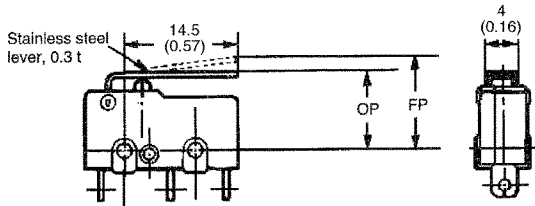

■ Simulated Roller Lever

SS-01GL13 (-E, -F)
 SS-5GL13 (-F)
 SS-10GL13

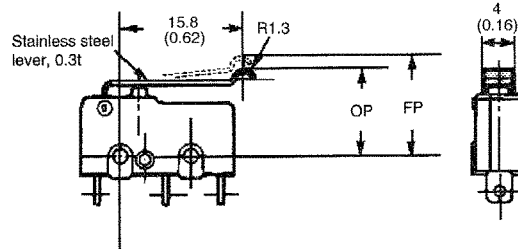

■ Formed Hinge Lever

SS-01GL14 (-E, -F)
 SS-5GL14 (-F)
 SS-10GL14

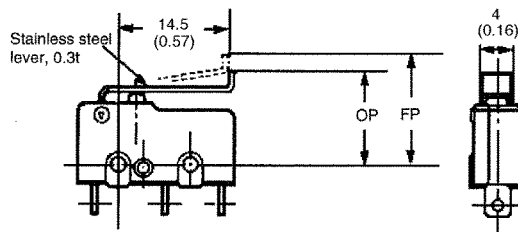

Note: 1. Unless otherwise specified, a tolerance of ± 0.4 mm applies to all dimensions.

2. Straight vertical PCB terminal models are shown above. Soldered terminal, Tab (#110) terminal, lead wire terminal, PCB terminal parallel to left and PCB terminal parallel to right are shown in the Terminals section.

■ Hinge Roller Lever

SS-01GL2 (-E, -F)
 SS-5GL2 (-F)
 SS-10GL2

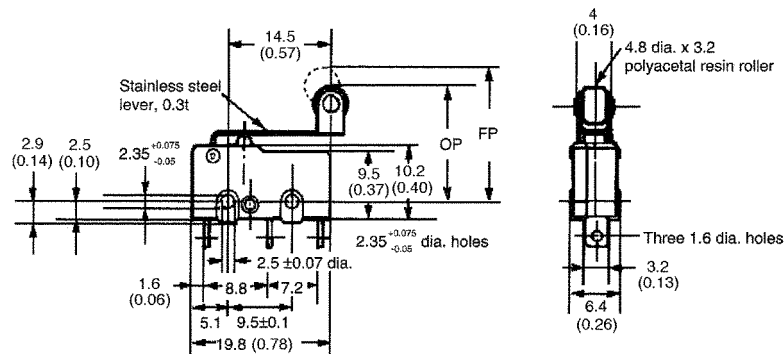

Note: Unless otherwise specified, a tolerance of ± 0.4 mm applies to all dimensions.

■ Mounting holes

Standard types

Mounting holes below are for reference only

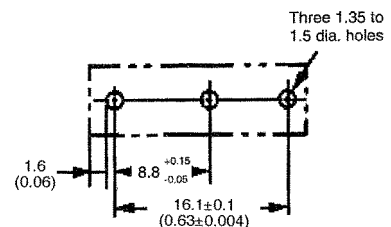
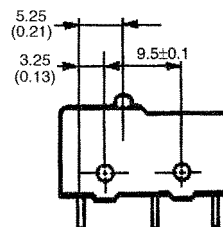
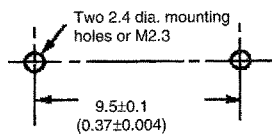

Note: Unless otherwise specified, a tolerance of ± 0.4 mm applies to all dimensions.

Unit: mm (inch)

■ Terminals

General-Purpose Type

PCB terminal, straight vertical (D)

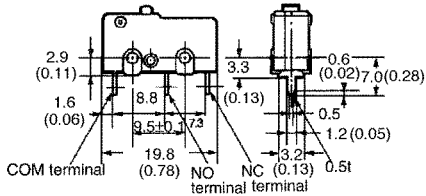

PCB terminal, parallel to left (D1)

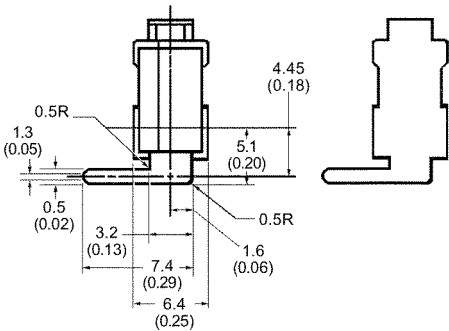

PCB terminal, parallel to right (D2)

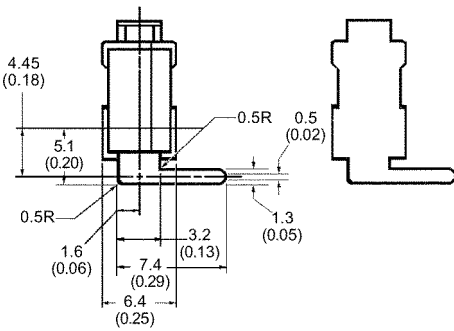

Note: Thickness of all the terminals is 0.5 mm.

Soldered terminal (blank)

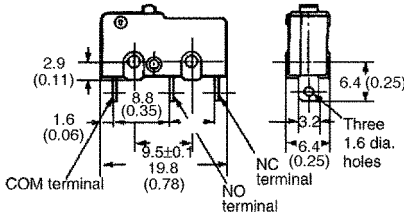

Quick-connect tab (#110) terminal (T)

