

**A3**

**Switches & Pilot Devices**



## LW Series offer flexibility in space-saving package

### Key features include:

- PC board mount, solder or screw terminal
- Collective mounting saves space
- Non-reflective lens
- Highly visible marking plate
- Tamper proof construction
- Light touch reduces strain
- Gold or silver contacts
- Removable contacts simplify wiring and facilitate PCB applications

LW Series switches and pilot lights can be mounted collectively on 1.0" centers. Combined with pcb terminals and locking lever removable contacts, this eases manufacture of pre-fab pushbutton arrays (as pictured). PC Board tracing/soldering of contacts can be done in tandem with panel cutting/operator installation.

All LW series units mount by means of a locking ring that comes on from the rear of the panel, as such they can not be removed from outside the panel and are relatively tamperproof.

Combining the snap action and tactile feel of miniature commercial pushbuttons with the size and ruggedness of industrial pushbuttons, LW pushbuttons are a unique solution to many applications.

Choose from standard silver contacts or low-level gold plated contacts. Terminals available in .110" solder tab, M3 screw, or pcb pins.

## Specifications

<b>Specifications</b>	<b>Operating Temperature</b>	-25 to +60°C (without freezing) LED illuminated type: -25 to +50°C		
	<b>Storage Temperature</b>	-40 to +80°C		
	<b>Operating Humidity</b>	45 to 85% RH		
	<b>Contact Resistance</b>	50mΩ maximum (initial value)		
	<b>Insulation Resistance</b>	100MΩ minimum (500V DC megger)		
	<b>Dielectric Strength</b>	<b>Switch Unit</b>	Between live part and ground: 2,500V AC, 1 minute Between terminals of different poles: 2,500V AC, 1 minute Between terminals of the same pole: 1,000V AC, 1 minute	
		<b>Illumination Unit</b>	Between live part and ground: 2,500V AC, 1 minute	
	<b>Vibration Resistance</b>	Operating extremes: 5 to 55Hz, Amplitude 1.0mm p-p		
	<b>Shock Resistance</b>	Damage limits: 1,000 m/sec <sup>2</sup> (Approx. 100G) Operating extremes: 100 m/sec <sup>2</sup> (Approx. 10G)		
	<b>Mechanical Life</b>	Momentary: 1,000,000 operations minimum Maintained: 500,000 operations minimum Selectors: 250,000 operations minimum		
	<b>Electrical Life</b>	Momentary: 100,000 operations minimum (at 1,800 operations/hour) Maintained/Selector: 100,000 operations minimum (at 900 operations/hour)		
	<b>Degree of Protection</b>	Watertight/oiltight IP65 (IEC Pub529) (except key selectors)		
	<b>Insulation Voltage</b>	250VAC/DC		
	<b>Materials</b>	<b>Lenses</b>	polyarylate	
<b>Operators</b>		polyacetate		
<b>Marking Plates</b>		acrylic resin		
<b>Terminal Style</b>	.110" Solder tab/quick connect PC board terminal (gold contacts only) Screw terminal (DPDT units only)			

A3

Switches & Pilot Devices

<b>Contact Ratings</b>	<b>Contact Material</b>	<b>Thermal Current</b>	<b>Contact Rating</b>	<b>Remarks</b>	
	<b>Gold-clad cross-bar</b>	3A	30VDC/0.1A resistive		Minimum applicable load (reference value): 5V, 1mA AC/DC. (Applicable range is subject to the operating condition and load.)
			125VAC/0.1A resistive		
	<b>Silver Contact</b>	5A	30VDC/2A resistive		
			30VDC/1A inductive		
			125VAC/3A resistive(50/60Hz)		
			125VAC/2A inductive (50/60Hz)		
			125VDC/0.4A resistive		
			125VDC/0.2A inductive		
			250VAC/2A resistive(50/60Hz)		
250VAC/1.5A inductive (50/60Hz)					
		AC inductive load: PF=0.6 to 0.7, DC inductive load: L/R=7ms maximum.			

### Lamp Ratings

	<b>Voltage</b>	<b>Current/Wattage</b>
<b>LED</b>	6V AC/DC ±10%	17mA max
	12V AC/DC ±10%	11mA max
	24V AC/DC ±10%	11mA max
	120V AC ±10%	10mA max
	240V AC ±10%	10mA max
<b>Incandescent</b>	6.3V AC/DC ±5%	1W
	12V AC/DC ±10%	1W
	24V AC/DC ±10%	1W

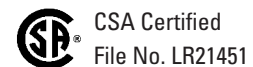





LED lamps contains a built-in current-limiting resistor and reverse polarity protection diode.

## Non-Illuminated Pushbuttons (Assembled)

### Part Numbers: LW1B/LW2B Pushbuttons

A3

Switches & Pilot Devices

Style	Contact Material	Contact	Part Number					
			Momentary			Maintained (Latching)		
			Solder/Tab	PC Board	Screw	Solder/Tab	PC Board	Screw
 Round Flush	Gold	SPDT	LW1B-M1C1-①	LW1B-M1C1V-①	—	LW1B-A1C1-①	LW1B-A1C1V-①	—
		DPDT	LW1B-M1C2-①	LW1B-M1C2V-①	LW1B-M1C2M-①	LW1B-A1C2-①	LW1B-A1C2V-①	LW1B-A1C2M-①
		3PDT	LW1B-M1C3-①	LW1B-M1C3V-①	—	LW1B-A1C3-①	LW1B-A1C3V-①	—
	Silver	SPDT	LW1B-M1C5-①	—	—	LW1B-A1C5-①	—	—
		DPDT	LW1B-M1C6-①	—	LW1B-M1C6M-①	LW1B-A1C6-①	—	LW1B-A1C6M-①
		3PDT	LW1B-M1C7-①	—	—	LW1B-A1C7-①	—	—
 Square Flush	Gold	SPDT	LW2B-M1C1-①	LW2B-M1C1V-①	—	LW2B-A1C1-①	LW2B-A1C1V-①	—
		DPDT	LW2B-M1C2-①	LW2B-M1C2V-①	LW2B-M1C2M-①	LW2B-A1C2-①	LW2B-A1C2V-①	LW2B-A1C2M-①
		3PDT	LW2B-M1C3-①	LW2B-M1C3V-①	—	LW2B-A1C3-①	LW2B-A1C3V-①	—
	Silver	SPDT	LW2B-M1C5-①	—	—	LW2B-A1C5-①	—	—
		DPDT	LW2B-M1C6-①	—	LW2B-M1C6M-①	LW2B-A1C6-①	—	LW2B-A1C6M-①
		3PDT	LW2B-M1C7-①	—	—	LW2B-A1C7-①	—	—
 Round Extended	Gold	SPDT	LW1B-M2C1-①	LW1B-M2C1V-①	—	LW1B-A2C1-①	LW1B-A2C1V-①	—
		DPDT	LW1B-M2C2-①	LW1B-M2C2V-①	LW1B-M2C2M-①	LW1B-A2C2-①	LW1B-A2C2V-①	LW1B-A2C2M-①
		3PDT	LW1B-M2C3-①	LW1B-M2C3V-①	—	LW1B-A2C3-①	LW1B-A2C3V-①	—
	Silver	SPDT	LW1B-M2C5-①	—	—	LW1B-A2C5-①	—	—
		DPDT	LW1B-M2C6-①	—	LW1B-M2C6M-①	LW1B-A2C6-①	—	LW1B-A2C6M-①
		3PDT	LW1B-M2C7-①	—	—	LW1B-A2C7-①	—	—
 Square Extended	Gold	SPDT	LW2B-M2C1-①	LW2B-M2C1V-①	—	LW2B-A2C1-①	LW2B-A2C1V-①	—
		DPDT	LW2B-M2C2-①	LW2B-M2C2V-①	LW2B-M2C2M-①	LW2B-A2C2-①	LW2B-A2C2V-①	LW2B-A2C2M-①
		3PDT	LW2B-M2C3-①	LW2B-M2C3V-①	—	LW2B-A2C3-①	LW2B-A2C3V-①	—
	Silver	SPDT	LW2B-M2C5-①	—	—	LW2B-A2C5-①	—	—
		DPDT	LW2B-M2C6-①	—	LW2B-M2C6M-①	LW2B-A2C6-①	—	LW2B-A2C6M-①
		3PDT	LW2B-M2C7-①	—	—	LW2B-A2C7-①	—	—
 Mushroom	Gold	SPDT	LW1B-M3C1-①	LW1B-M3C1V-①	—	LW1B-A3C1-①	LW1B-A3C1V-①	—
		DPDT	LW1B-M3C2-①	LW1B-M3C2V-①	LW1B-M3C2M-①	LW1B-A3C2-①	LW1B-A3C2V-①	LW1B-A3C2M-①
		3PDT	LW1B-M3C3-①	LW1B-M3C3V-①	—	LW1B-A3C3-①	LW1B-A3C3V-①	—
	Silver	SPDT	LW1B-M3C5-①	—	—	LW1B-A3C5-①	—	—
		DPDT	LW1B-M3C6-①	—	LW1B-M3C6M-①	LW1B-A3C6-①	—	LW1B-A3C6M-①
		3PDT	LW1B-M3C7-①	—	—	LW1B-A3C7-①	—	—

- In place of ①, specify Button Color Code from table below.
- For sub-assembly part numbers, see page A3-111.
- For dimensions, see page A3-120.
- For accessories, see page A3-119.

### Part Numbers: Buzzers (IP20)

Style		Part Number	
		Solder Tab	PCB
	Basic	LW1Z-1X4	LW1Z-1X4V
	With LED	LW1Z-1X4D	LW1Z-1X4DV

### ① Button Color Code

Color	Code
Black	B
Green	G
Red	R
Blue	S
White	W
Yellow	Y

 12-24V AC/DC +/- 10%  
 80 dB (at 0.1m)  
 7mA (DC), 20mA (AC)

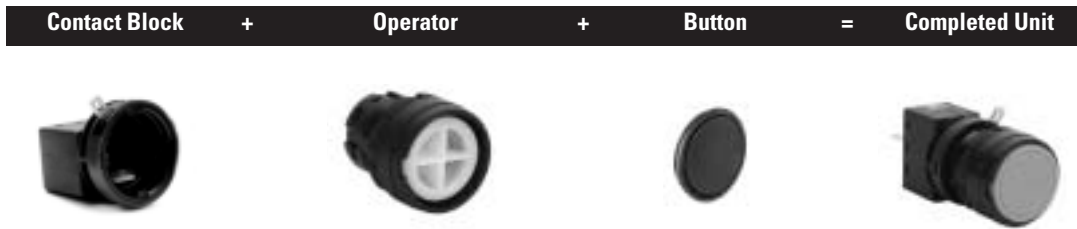

## Non-Illuminated Pushbuttons (Sub-Assembled)



### Part Numbers: Operators

Style		Part Number	
		Momentary	Maintained
Round		LW1B-M0	LW1B-A0
Square		LW2B-M0	LW2B-A0
Mushroom		LW1B-M0L	LW1B-A0L

### Part Numbers: Buttons

Type		Part Number	
		Flush	Extended
Round		LW1A-B1-①	LW1A-B2-①
Square		LW2A-B1-①	LW2A-B2-①
Mushroom		—	LW1A-B3-①

#### ① Button Color Code

Color	Code
Black	B
Green	G
Red	R
Blue	S
White	W
Yellow	Y



In place of ①, specify Button Color Code from table at right.



### Part Numbers: Contact Blocks

Appearance	Contact Material	Contact	Part Number		
			Solder/Tab	PC Board	Screw
	Gold	SPDT	LW-C1	LW-C1V	—
		DPDT	LW-C2	LW-C2V	LW-C2M
		3PDT	LW-C3	LW-C3V	—
	Silver	SPDT	LW-C5	—	—
		DPDT	LW-C6	—	LW-C6M
		3PDT	LW-C7	—	—

**LED and Incandescent Illuminated Pushbuttons (Assembled)**



**Part Numbers: LW1L/LW2L Illuminated Pushbuttons (LED and Incandescent)**

**A3**  
**Switches & Pilot Devices**

Style	Contact Material	Contact	Part Number					
			Momentary			Maintained (Latching)		
			Solder/Tab	PC Board	Screw	Solder/Tab	PC Board	Screw
	Gold	SPDT	LW1L-M1C10-②	LW1L-M1C10V-②	—	LW1L-A1C10-②	LW1L-A1C10V-②	—
		DPDT	LW1L-M1C20-②	LW1L-M1C20V-②	LW1L-M1C20M-②	LW1L-A1C20-②	LW1L-A1C20V-②	LW1L-A1C20M-②
		3PDT	LW1L-M1C30-②	LW1L-M1C30V-②	—	LW1L-A1C30-②	LW1L-A1C30V-②	—
	Silver	SPDT	LW1L-M1C50-②	—	—	LW1L-A1C50-②	—	—
		DPDT	LW1L-M1C60-②	—	LW1L-M1C60M-②	LW1L-A1C60-②	—	LW1L-A1C60M-②
		3PDT	LW1L-M1C70-②	—	—	LW1L-A1C70-②	—	—
	Gold	SPDT	LW2L-M1C10-②	LW2L-M1C10V-②	—	LW2L-A1C10-②	LW2L-A1C10V-②	—
		DPDT	LW2L-M1C20-②	LW2L-M1C20V-②	LW2L-M1C20M-②	LW2L-A1C20-②	LW2L-A1C20V-②	LW2L-A1C20M-②
		3PDT	LW2L-M1C30-②	LW2L-M1C30V-②	—	LW2L-A1C30-②	LW2L-A1C30V-②	—
	Silver	SPDT	LW2L-M1C50-②	—	—	LW2L-A1C50-②	—	—
		DPDT	LW2L-M1C60-②	—	LW2L-M1C60M-②	LW2L-A1C60-②	—	LW2L-A1C60M-②
		3PDT	LW2L-M1C70-②	—	—	LW2L-A1C70-②	—	—
	Gold	SPDT	LW1L-M3C10-②	LW1L-M3C10V-②	—	LW1L-A3C10-②	LW1L-A3C10V-②	—
		DPDT	LW1L-M3C20-②	LW1L-M3C20V-②	LW1L-M3C20M-②	LW1L-A3C20-②	LW1L-A3C20V-②	LW1L-A3C20M-②
		3PDT	LW1L-M3C30-②	LW1L-M3C30V-②	—	LW1L-A3C30-②	LW1L-A3C30V-②	—
	Silver	SPDT	LW1L-M3C50-②	—	—	LW1L-A3C50-②	—	—
		DPDT	LW1L-M3C60-②	—	LW1L-M3C60M-②	LW1L-A3C60-②	—	LW1L-A3C60M-②
		3PDT	LW1L-M3C70-②	—	—	LW1L-A3C70-②	—	—

-  1. In place of ②, specify the Lens Color Code from table below.  
 2. Lamps must be ordered separately for all illuminated pushbuttons.  
 3. For marking plate size and engraving area, see page A3-124.  
 4. For sub-assembly part numbers, see page A3-113.  
 5. For dimensions, see page A3-120.  
 5. For accessories, see page A3-119.

**Part Numbers: Lamps (not included in assemblies)**

Type	Voltage	Part Number
	6V AC/DC±10%	LSTD-6②
	12V AC/DC±10%	LSTD-1②
	24V AC/DC±10%	LSTD-2②
	120V AC±10%	LSTD-H2②
	240V AC ±10%	LSTD-M4②
	6.3V AC/DC	IS-6
	12V AC/DC	IS-12
	24V AC/DC	IS-24

-  1. In place of ②, specify the LED Color Code.  
 2. The LED contains a current-limiting resistor and reverse polarity protection diode.

**② Lens/LED Color Code**

Color	Code
Amber	A
Green	G
Red	R
Blue	S
White	W
Yellow	Y

## LED and Incandescent Illuminated Pushbuttons (Sub-Assembled)

Contact Block + Operator + Lamp + Lens = Completed Unit





A3

Switches & Pilot Devices

### Part Numbers: Operators

Style	Part Number	
	Momentary	Maintained
Round 	LW1L-M0	LW1L-A0
Square 	LW2L-M0	LW2L-A0
Mushroom 	LW1B-M0L	LW1B-A0L

### Part Numbers: Lenses

Type	Part Number	
	Flush	
Round 	LW1A-L1-②	
Square 	LW2A-L1-②	
Mushroom 	LW1A-L3-②	





In place of ②, specify Lens Color Code from table below.

### Part Numbers: Contact Blocks

Appearance	Contact Material	Contact	Part Number		
			Solder/Tab	PC Board	Screw
	Gold	SPDT	LW-C10	LW-C10V	—
		DPDT	LW-C20	LW-C20V	LW-C20M
		3PDT	LW-C30	LW-C30V	—
	Silver	SPDT	LW-C50	—	—
		DPDT	LW-C60	—	LW-C60M
		3PDT	LW-C70	—	—

### Part Numbers: Lamps (not included in assemblies)

Type	Voltage	Part Number
LED 	6V AC/DC±10%	LSTD-6②
	12V AC/DC±10%	LSTD-1②
	24V AC/DC±10%	LSTD-2②
	120V AC±10%	LSTD-H2②
	240V AC ±10%	LSTD-M4②
Incandescent 	6.3V AC/DC	IS-6
	12V AC/DC	IS-12
	24V AC/DC	IS-24

### ② LED/Lens Color Code

Color	Code
Amber	A
Green	G
Red	R
Blue	S
White	W
Yellow	Y



- In place of ②, specify the LED Color Code.
- The LED contains a current-limiting resistor and reverse polarity protection diode.

**LED and Incandescent Pilot Lights (Assembled)**

**Part Numbers: LW1P/LW2P Pilot Lights**



**A3**

**Switches & Pilot Devices**

Type	Style	Part Number		
		Solder/Tab	PC Board	Screw
Removable Terminal Pilot Light	Round 	—	LW1P-1C00V-②	—
	Square 	—	LW2P-1C00V-②	—
Unibody Pilot Light	Round 	LW1P-10-②	—	LW1P-10M-②
	Square 	LW2P-10-②	—	LW2P-10M-②

- 1. In place of ②, specify the Lens Color Code from table below.
- 2. For marking plate size and engraving area, see page A3-124.
- 3. Lamps must be ordered separately, see table below.
- 4. For sub-assembly part numbers, see page A3-115.
- 5. For dimensions, see page A3-120.
- 6. For accessories, see page A3-119.

**Part Numbers: Lamps (not included in assemblies)**

Type	Voltage	Part Number
LED 	6V AC/DC±10%	LSTD-6②
	12V AC/DC±10%	LSTD-1②
	24V AC/DC±10%	LSTD-2②
	120V AC±10%	LSTD-H2②
	240V AC ±10%	LSTD-M4②
Incandescent 	6.3V AC/DC	IS-6
	12V AC/DC	IS-12
	24V AC/DC	IS-24

**② Lens/LED Color Code**

Color	Code
Amber	A
Green	G
Red	R
Blue	S
White	W
Yellow	Y

- 1. In place of ②, specify the LED Color Code.
- 2. The LED contains a current-limiting resistor and reverse polarity protection diode.

## LED and Incandescent Pilot Lights (Sub-Assembled)

A3



Switches & Pilot Devices

Removable Terminal\* + Operator + Lamp + Lens = Completed Unit



\* Removable terminals are applicable for PCB terminated types only.

### Part Numbers: Pilot Light Operators

Style	Termination		
	Solder	PC Board	Screw
Round 	LW1P-00	LW1P-0 †	LW1P-00M
Square 	LW2P-00	LW2P-0 †	LW2P-00M



- † Requires LW-C00V removable terminals in addition to operator.
- Solder and screw terminals are unibody design (they do not use a removable terminal block).



### Part Numbers: Lenses

Type	Part Number
Round 	LW1A-P1-②
Square 	LW2A-P1-②



In place of ②, specify Lens Color Code.

### Part Numbers: Lamps (not included in assemblies)

Type	Voltage	Part Number
LED 	6V AC/DC±10%	LSTD-6②
	12V AC/DC±10%	LSTD-1②
	24V AC/DC±10%	LSTD-2②
	120V AC±10%	LSTD-H2②
	240V AC ±10%	LSTD-M4②
Incandescent 	6.3V AC/DC	IS-6
	12V AC/DC	IS-12
	24V AC/DC	IS-24



- In place of ②, specify the LED Color Code.
- The LED contains a current-limiting resistor and reverse polarity protection diode.



### ② LED/Lens Color Code

Color	Code
Amber	A
Green	G
Red	R
Blue	S
White	W
Yellow	Y





## Selector and Keylock Switches (Assembled)

### Part Numbers: LW1S Selector Switches

Style	Position	Contact Material	Contact	Part Number		
				Solder/Tab	PC Board	Screw
Round 	90° 2-position maintained 	Gold	SPDT	LW1S-2C1	LW1S-2C1V	—
			DPDT	LW1S-2C2	LW1S-2C2V	LW1S-2C2M
			3PDT	LW1S-2C3	LW1S-2C3V	—
		Silver	SPDT	LW1S-2C5	—	—
			DPDT	LW1S-2C6	—	LW1S-2C6M
			3PDT	LW1S-2C7	—	—
	45° 3-position maintained 	Gold	DPDT	LW1S-3C2	LW1S-3C2V	LW1S-3C2M
			3PDT	LW1S-3C3	LW1S-3C3V	—
		Silver	DPDT	LW1S-3C6	—	LW1S-3C6M
			3PDT	LW1S-3C7	—	—



-  1. Knob color: Black; Directional Indication Color: White  
 2. For contact operation, see next page.  
 3. For sub-assembly part numbers, see page A3-118.

### Part Numbers: LW1K Keylock Selector Switches

Style	Position	Contact Material	Contact	Part Number		
				Solder/Tab	PC Board	Screw
Round 	90° 2-position maintained 	Gold	SPDT	LW1K-2C1A	LW1K-2C1VA	—
			DPDT	LW1K-2C2A	LW1K-2C2VA	LW1K-2C2MA
			3PDT	LW1K-2C3A	LW1K-2C3VA	—
		Silver	SPDT	LW1K-2C5A	—	—
			DPDT	LW1K-2C6A	—	LW1K-2C6MA
			3PDT	LW1K-2C7A	—	—
	45° 3-position maintained 	Gold	DPDT	LW1K-3C2A	LW1K-3C2VA	LW1K-3C2MA
			3PDT	LW1K-3C3A	LW1K-3C3VA	—
		Silver	DPDT	LW1K-3C6A	—	LW1K-3C6MA
			3PDT	LW1K-3C7A	—	—

-  1. Every key selector uses an identical key.  
 2. The key is removable in all positions.  
 3. If a different configuration is required, contact an IDEC representative for more information.  
 4. For contact operation, see next page.  
 5. For sub-assembly part numbers, see page A3-118.

### Part Numbers: LW1F LED and Incandescent Illuminated Selector Switches

Style	Position	Contact Material	Contact	Part Numbers		
				Solder/Tab	PC Board	Screw
Round 	90° 2-position maintained 	Gold	SPDT	LW1F-2C10-②	LW1F-2C10V-②	—
			DPDT	LW1F-2C20-②	LW1F-2C20V-②	LW1F-2C20M-②
			3PDT	LW1F-2C30-②	LW1F-2C30V-②	—
		Silver	SPDT	LW1F-2C50-②	—	—
			DPDT	LW1F-2C60-②	—	LW1F-2C60M-②
			3PDT	LW1F-2C70-②	—	—
	45° 3-position maintained 	Gold	DPDT	LW1F-3C20-②	LW1F-3C20V-②	LW1F-3C20M-②
			3PDT	LW1F-3C30-②	LW1F-3C30V-②	—
		Silver	DPDT	LW1F-3C60-②	—	LW1F-3C60M-②
			3PDT	LW1F-3C70-②	—	—

-  1. In place of ②, specify color code. See previous page for color codes.  
 2. Lamps must be ordered separately for all illuminated pushbuttons. See previous page.  
 3. For contact operation, see next page.  
 4. For sub-assembly part numbers, see page A3-118.

## Contact Operations

### Contact Operation: Selector and Keylock Switches

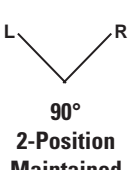
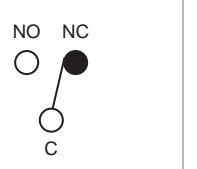
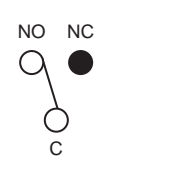
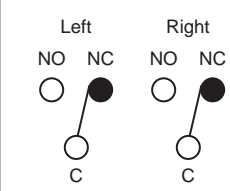
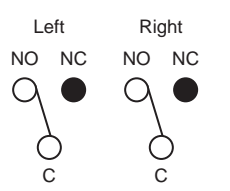
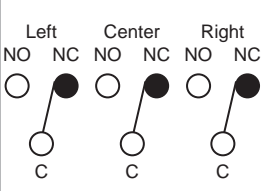
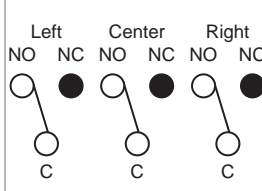
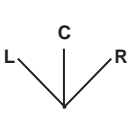
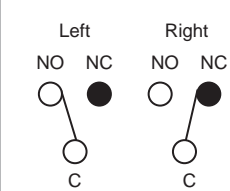
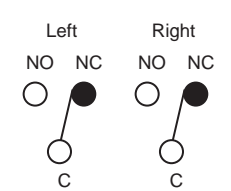
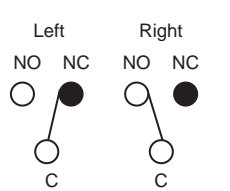
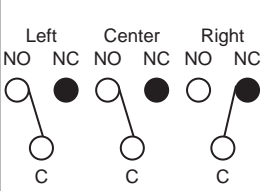
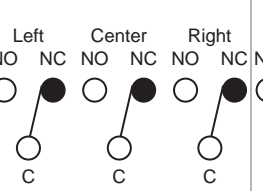
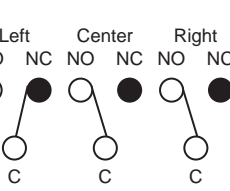
Position	Contact	Operator Position and Contact Position (Top View)		
		Left	Center	Right
 <p>90° 2-Position Maintained</p>	SPDT		-	
	DPDT		-	
	3PDT		-	
 <p>45° 3-Position Maintained</p>	DPDT			
	3PDT			

### Terminal Arrangements (Bottom View): LW□L and LW□B Pushbuttons

3 pole illuminated

2 pole illuminated

3 pole non-illuminated

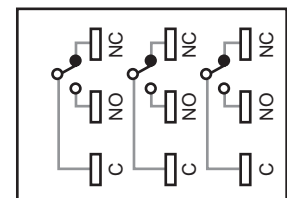
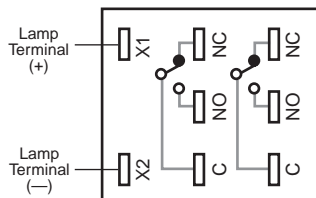
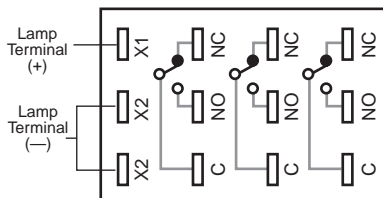

SPDT has C, NO and NC only on the center. DPDT has C, NO, and NC only on the right and left.



SPDT has C, NO and NC only on the right. DPDT has C, NO, and NC only on the right and center.

## Selectors and Key Switches (Sub-Assembled)

A3

Switches & Pilot Devices



\*Lens for illuminated units only

### Part Numbers: Operators

Unit	Position	Part Number
Non-Illuminated Selector Switch	2-position	LW1S-2Y
	3-position	LW1S-3Y
Key Switch	2-position	LW1K-2A
	3-position	LW1K-3A
Illuminated Selector Switch	2-position	LW1F-20*
	3-position	LW1F-30*

\* Lens must be purchased separately for illuminated units.

### Part Numbers: Knob (Lens)

Style	Part Number
Illuminated Selector Switches	LW1A-F-②



In place of ②, specify LED/Lens Color Code from table below.

### Part Numbers: Contact Blocks

Appearance	Style	Contact Material	Contact	Part Number		
				Solder/Tab	PC Board	Screw
	Illuminated Selector Switches	Gold	SPDT	LW-C10	LW-C10V	—
			DPDT	LW-C20	LW-C20V	LW-C20M
			3PDT	LW-C30	LW-C30V	—
		Silver	SPDT	LW-C50	—	—
			DPDT	LW-C60	—	LW-C60M
			3PDT	LW-C70	—	—
	Non-Illuminated Selector Switches	Gold	SPDT	LW-C1	LW-C1V	—
			DPDT	LW-C2	LW-C2V	LW-C2M
			3PDT	LW-C3	LW-C3V	—
		Silver	SPDT	LW-C5	—	—
			DPDT	LW-C6	—	LW-C6M
			3PDT	LW-C7	—	—

### Part Numbers: Lamps (not included in assemblies)

Type	Voltage	Part Number
LED	6V AC/DC±10%	LSTD-6②
	12V AC/DC±10%	LSTD-1②
	24V AC/DC±10%	LSTD-2②
	120V AC±10%	LSTD-H2②
	240V AC ±10%	LSTD-M4②
Incandescent	6.3V AC/DC	IS-6
	12V AC/DC	IS-12
	24V AC/DC	IS-24















### ② LED/Lens Color Code

Color	Code
Amber	A
Green	G
Red	R
Blue	S
White	W
Yellow	Y

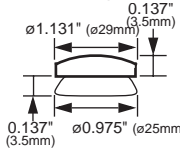

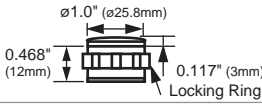
- In place of ②, specify the LED Color Code.
- The LED contains a current-limiting resistor and reverse polarity protection diode.

## Accessories — LW Series

Style	Description/Usage	Part Number
Ring Wrench (optional) 	1. Metallic tool used for tightening the plastic locking ring when installing the LW series on a panel. 2. Tightening torque should not exceed 1.2N-m (12 kgf-cm) when tightening a locking ring.	LW9Z-T1
Lamp Holder Tool (optional) 	Rubber tool used for replacing incandescent or LED lamps installed in illuminated switches and pilot lights and pilot lights 	OR-55
Terminal Cover (for solder tab terminal) 	Nylon cover for pushbuttons and selectors with solder terminals snaps onto contact block. (Insert the lead wires through terminal cover holes before wiring.)	LW-VL2
Terminal Cover (for screw terminal) 	Nylon cover for pushbuttons and selectors for screw terminals snaps onto contact block. (Insert the lead wires through terminal cover holes before wiring.)	LW-VL2M
Terminal Cover (for unibody pilot light with solder tab terminal) 	Nylon cover for unibody pilot lights with solder terminals.	LW-PVL
Terminal Cover (for unibody pilot light with screw terminal) 	Nylon cover for unibody pilot lights with screw terminals.	LW-PVLM
Rubber Mounting Hole Plug 	Black rubber plug fills unused 22mm panel cutouts. 	OB-31
Metallic Mounting Hole Plug 	1. Used for plugging unnecessary mounting holes in the panel. Tighten the attached locking ring to a torque of 1.2N-m (12kgf-cm) maximum 2. Degree of Protection: IP66 	LW9Z-BM
Replacement Marking Plates 	White plastic engraving plate for use on all illuminated units (included in each lens). May be used to capture printed mylar insert (not supplied by IDEC) under lens face.	LW9Z-P1-W (round) LW9Z-P2-W (square) ALW3B (mushroom)
Anti-Rotation Ring 	Prevents rotation of switches in panel. (included with all selector and key switches only)	LW9Z-L
Replacement Keys 	One pair of keys. (#231)	KG9Z-SK
Replacement Locking Ring 	Use to secure operator to panel. (included with all assembled switches and operators)	LW9Z-LN

A3

Switches & Pilot Devices



For replacement lamps, see previous page.

**Dimensions: Pushbuttons**

**LW□L & LW□B: Illuminated & Non-Illuminated Pushbuttons**

**A3**  
**Switches & Pilot Devices**

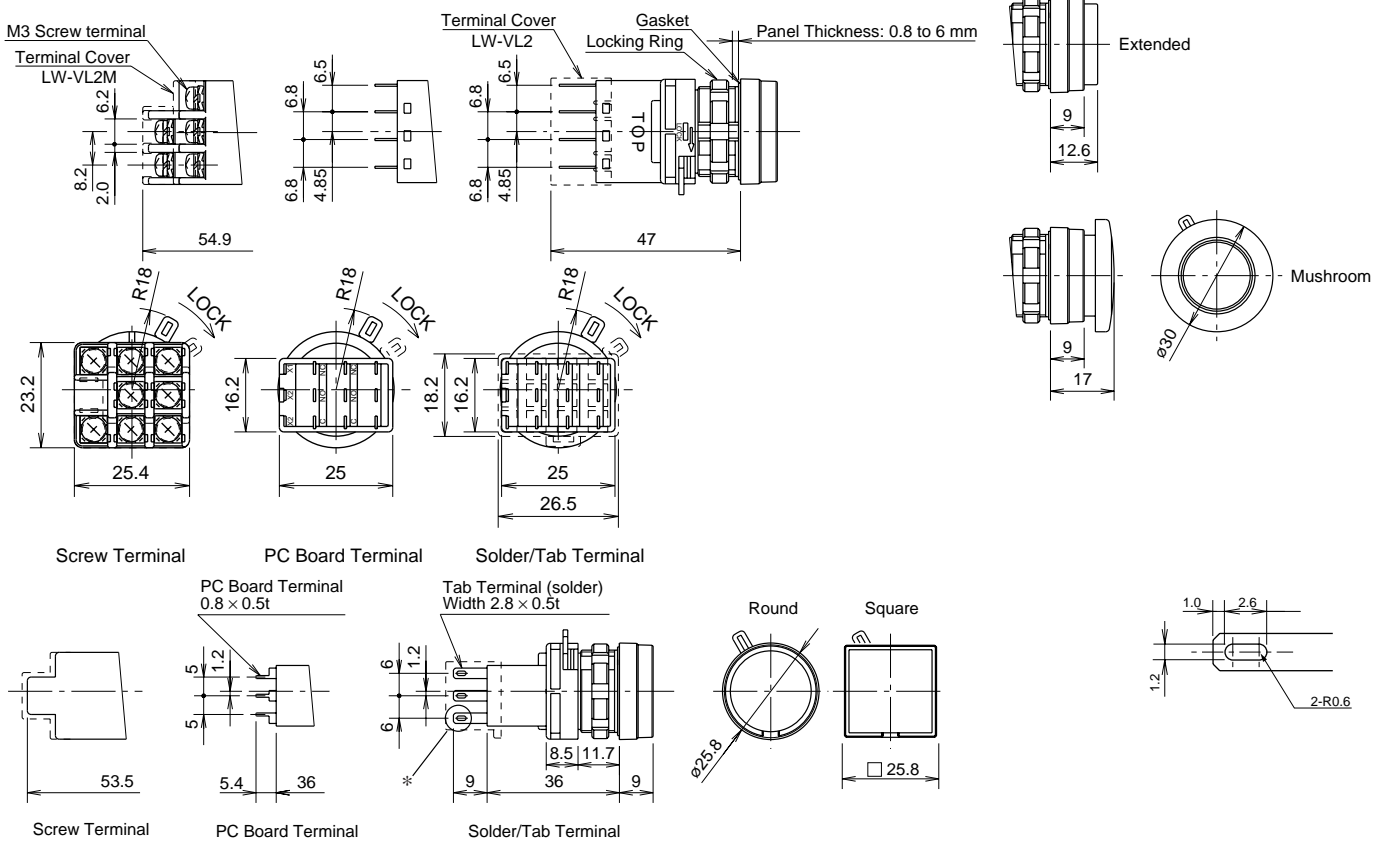
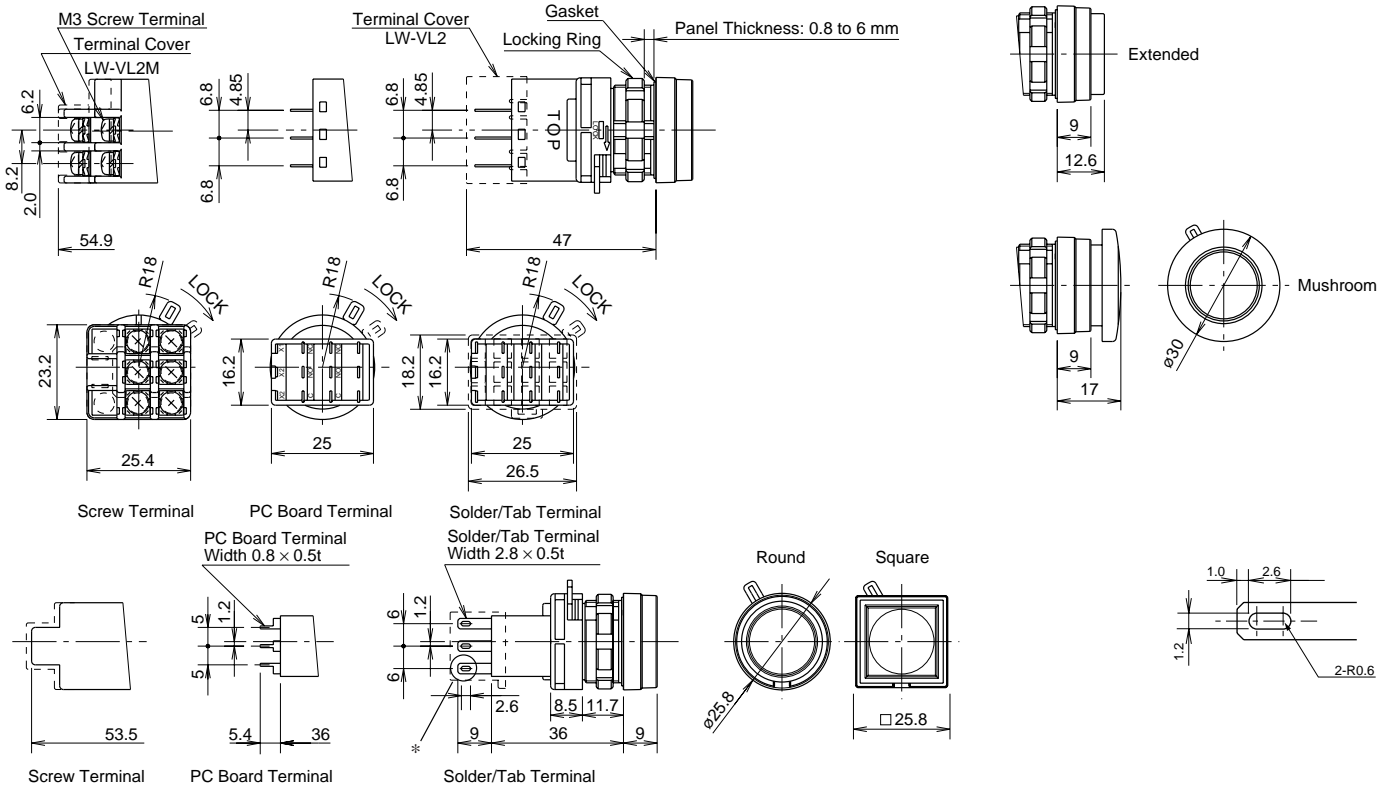

**Dimensions: Pilot Lights**

**LW1P/LW2P Pilot Lights**

**A3**

**Switches & Pilot Devices**

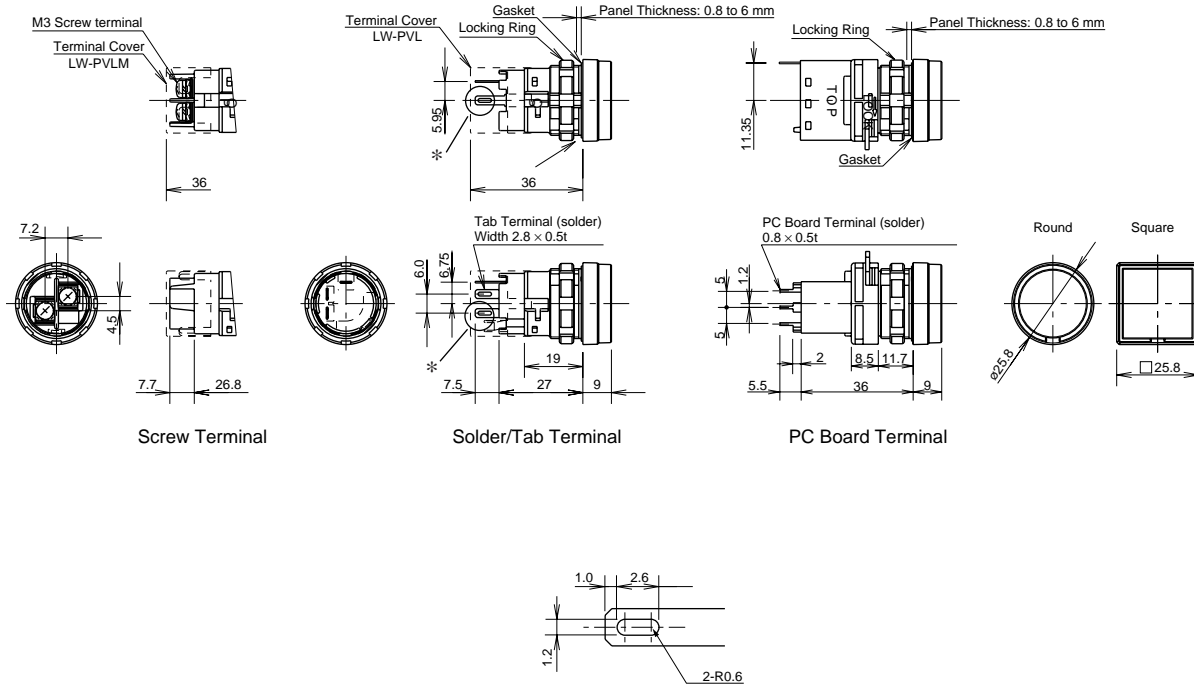

## Dimensions: Selector and Keylock Switches

### LW1S and LW1K Selector and Keylock Switches

Switches & Pilot Devices

A3

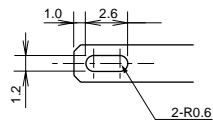
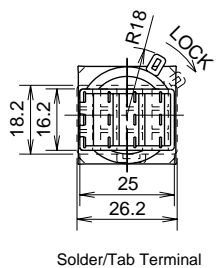
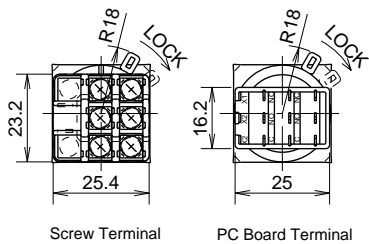
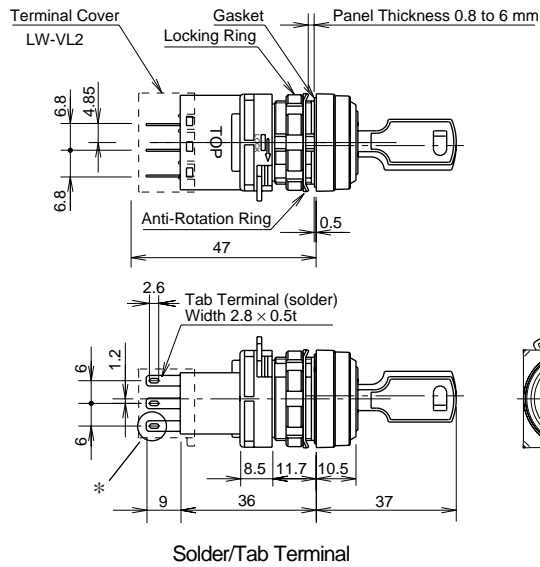
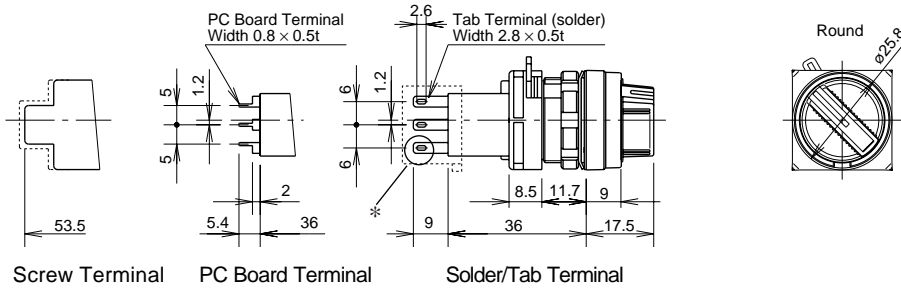
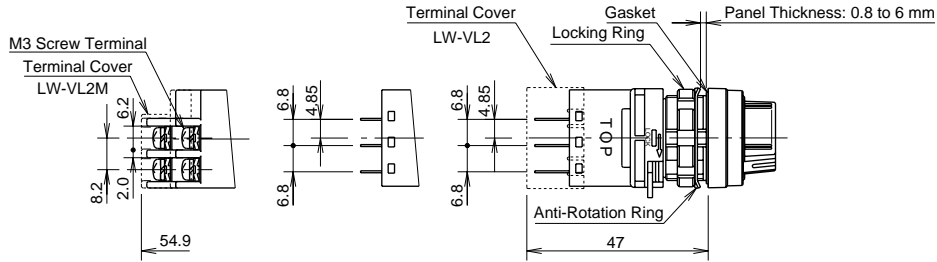





## Replacement of Lens & Marking Plate

A3

### Removing

1. Remove the operator (lens, marking plate, and lens holder) by inserting a screwdriver into the recess of the lens through the bezel.



2. Remove the marking plate by pushing the lens from the rear to disengage the latches between the lens and the lens holder, using the screwdriver as shown below.



The translucent filter in the lens holder can not be removed because this filter is sealed to make the unit waterproof and oiltight.

### Installing

For round lens types, place the marking plate on the lens holder with the anti-rotation projection engaged and press the lens onto the lens holder to engage the latches. For square lens types, insert the marking plate into the lens, and press the lens onto the lens holder to engage the latches. Pay attention to the orientation of the marking plate.

Pay attention to the orientation of the marking plate.

For Round Lens

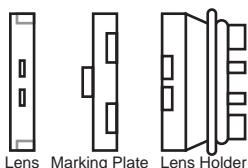

For Square Lens

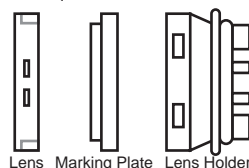

## Replacement of Lamps

Lamps can be replaced using the lamp holder tool (OR-55) from the front of the panel. Also by removing the contact block from the operator unit, the lamp can be replaced.

### Replacement of Lamps from the Front of the Panel.

#### (How to Remove)

1. Push and turn the lamp counterclockwise using the side A of the lamp holder tool, and the lamp and the lamp holder can be removed.



#### (How to Install)

1. Insert the lamp into the lamp holder tool and hold the lamp as in the following illustration.

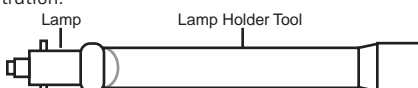

2. Place the insertion guide of the lamp and the groove in the operator unit in

the same direction. Then push the lamp lightly and turn it clockwise.

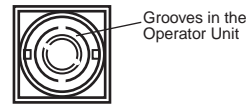

### Replacement of Lamps by Removing the Contact Block

The lamp can be replaced by removing the contact block without using the lamp holder tool.

## Marking Plates & Films

For LW series illuminated pushbuttons and pilot lights, legends and symbols can be engraved on marking plates, or printed mylar can be inserted under the lens for labelling purposes.

### Marking Plate and Marking Film Size

Lens Style	Round Lens	Square Lens
<b>Built-in Marking Plate</b>		
Engraving must be made on the engraving area within 0.02" (0.5mm) deep. The marking plate is made of white acrylic resin.		
<b>Applicable Marking Film</b>		
Mylar for printing labels are not included and must be provided and printed by user. Two 0.004" (0.1mm)-thick films or one 0.008" (0.2mm)-thick film can be installed in the lens. Recommended marking film: Mylar		

### Insertion Order of Marking Plate & Film

For Round Lens

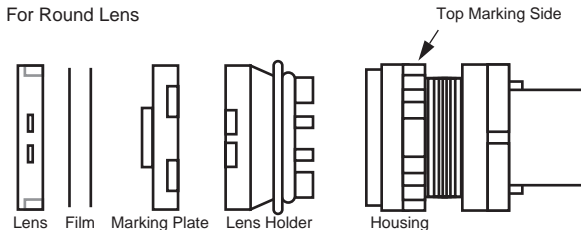

### Insertion Order of Marking Plate & Film.

For Square Lens

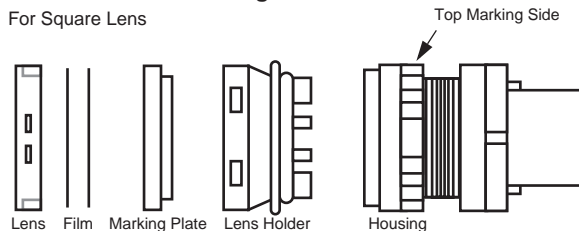

1. Mylar is not included.

2. Pay attention to the orientation of marking plate.

## Instructions con't

### Panel Mounting

Remove the contact block from the operator. Insert the operator into the panel cut-out from the front, then install the contact block to the operator.

#### Removing the Contact Block

Turn the locking lever on the contact block in the direction opposite to the arrow on the housing. Then the contact block can be removed.

#### Installing the Contact Block

Insert the contact block, with the TOP markings on the contact block and the operator placed in the same direction. Then lock the units, turning the locking lever in the direction of the arrow.



#### Notes on Mounting

Use the optional Ring Wrench (LW9Z-T1) to mount the operator onto a panel. Tightening torque should not exceed 1.2N-m (12 kgf-cm). Do not use pliers. Excessive tightening will damage the locking ring.

### Wiring

1. Solder the terminals within 20W/5 seconds or 260°C/3 seconds without exerting external force to the terminals. While soldering, do not touch the soldering iron to the housing. While wiring, prevent tension from being applied to the terminals. Do not bend or raise the terminals, nor exert excessive force to terminals.
2. Use a non-corrosive resin liquid flux.

#### Collective Mounting

As the locking lever can be turned easily from the rear of the units using a screwdriver, the contact blocks can be removed even when mounted collectively.

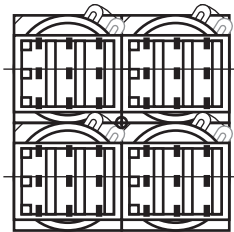

### Notes for Terminal Cover

#### (Solder/Tab Terminal)

Insert the terminal cover into the contact block with the TOP markings on the contact block and the terminal cover in the same direction.



When wiring, insert the lead wires into the terminal cover holes before wiring.



#### Notes for Wiring

When installing a terminal cover onto the solder/tab terminal contact block, solder the inside of lamp terminal (toward the switch terminals) and wire.

#### (Screw Terminal Type)

Install a terminal cover to the control unit before wiring.



1. After wiring, terminal covers cannot be installed.
2. When terminal covers are used, round crimping terminals cannot be used.

### Connection

Positive-lock connector and easy-lock connector are applicable to tab terminals.

### Single Board Mounting

Mounting the switches and pilot lights on one PC board offers the following features.

1. Reduced installation labor, easy wiring, space saving, and standardization.
2. Since the contact blocks on the PC board can be removed easily using a locking lever, the LW series switches and pilot lights are easy to maintain.
3. Because the LW series switches and pilot lights require no studs for fastening the control unit to a PC board, special preparation of operation panel is not needed.

For details on one board mounting, contact IDEC.



### Light Touch And High Reliability

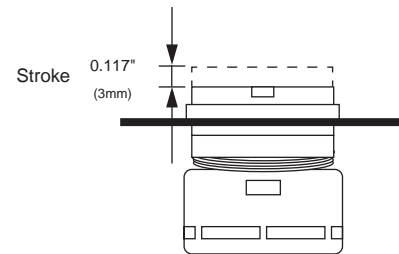

### Operating-force Snap Switching Mechanism

