



*Think Automation and beyond...*



***The New** MicroSmart Pentra PLC Family*

*"The features and adaptability of MicroSmart PLCs make them my first choice for applications now and in the future!" – Design Engineer*



# The Power to Control. Anywhere. Anytime.

## Power, Performance, Connectivity

Maximize efficiency and cut development time! MicroSmart Pentra PLCs combine advanced networking capabilities with unparalleled power, performance and connectivity. Designed to meet all your communication requirements, now and in the future, MicroSmart Pentra PLCs give you the flexibility to expand your system with as many as fifteen modules! Our new Embedded Ethernet PLC with built-in Modbus TCP also lets you remotely monitor status in real-time, receive email alerts and customize your own web page.

## Safety

All MicroSmart Pentra PLCs meet the highest standards for safety including: cULus listed for Class 1 Division 2 hazardous locations\*, CE compliant, as well as certified for marine use by ABS, DNV, and Lloyd's Registry\*.



\*Not applicable for all models. Visit [www.IDEC.com/approvals](http://www.IDEC.com/approvals) for details.



## The MicroSmart Pentra PLC Family: Everything you need in a controller



Embedded Ethernet Port



Modbus TCP, RTU and ASCII



Seven communication ports

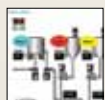

User web page

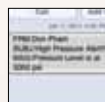

Email and text notifications



USB programming port



NEW Advanced PID control modules



NEW 4-pt. analog output module

# Choose a CPU for every application

With three controller types to choose from, MicroSmart Pentra PLCs offer the features you need for your applications. Built to allow you the flexibility to expand when you need to, MicroSmart Pentra PLCs are the best way to get everything you need in just one controller.

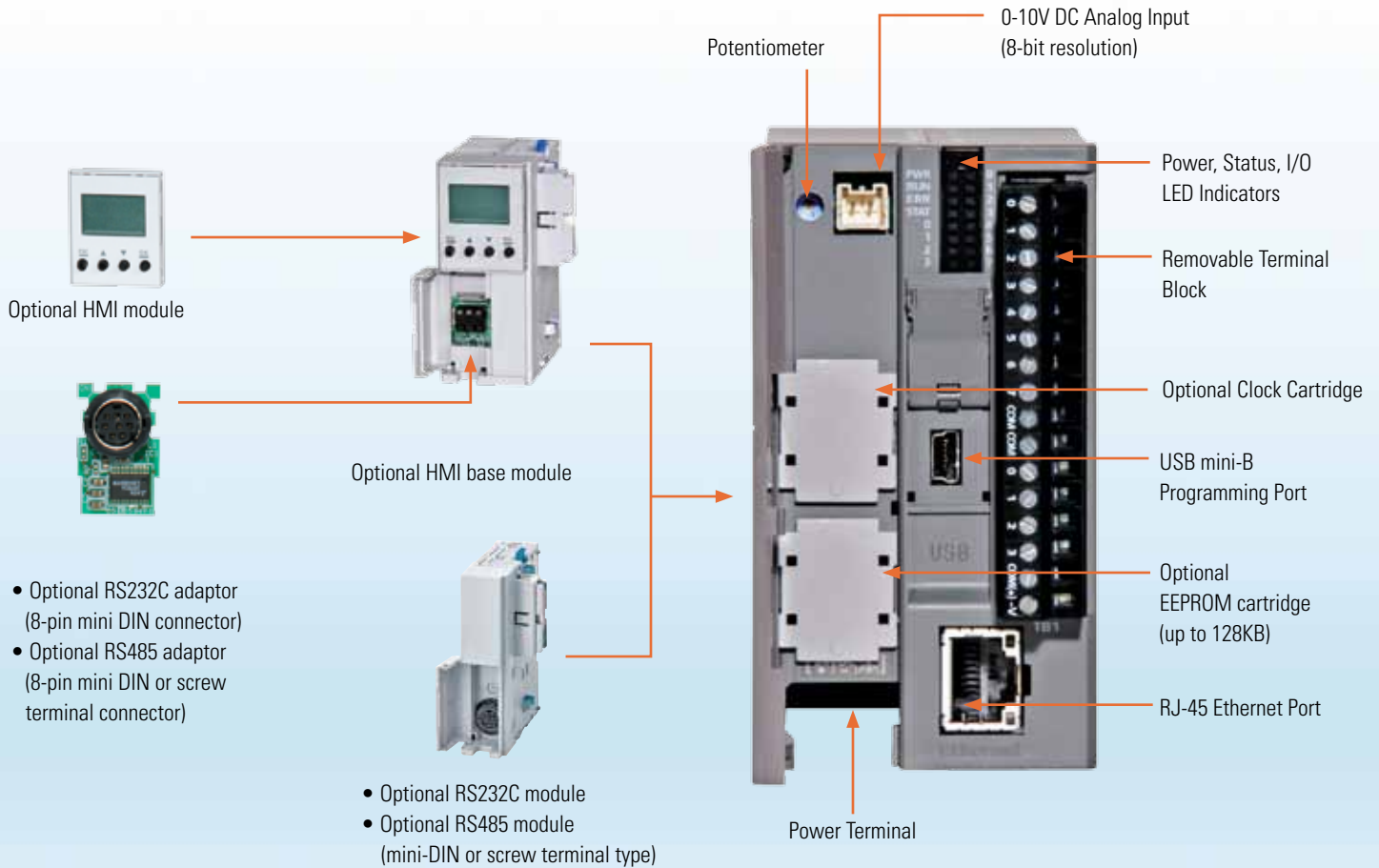

Modules snap together easily without the need for additional tools.

## Slim CPU with Ethernet Port

The perfect design when you need Ethernet capability, this slim CPU with embedded Ethernet port is available with 24V DC power and equipped with eight DC inputs and four transistor outputs (sink or source). Up to seven functional modules, including analog and communication modules can be mounted on the right-hand expansion bus. Using an expansion interface module, an additional eight discrete expansion modules can be mounted.

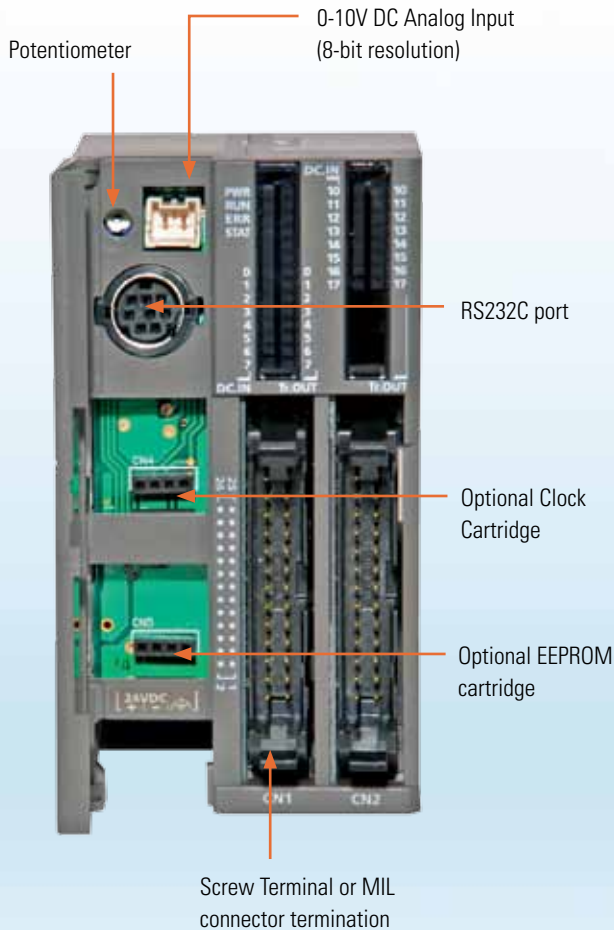

## Slim CPU

If you don't need Ethernet, but still want a high-performance CPU, the MicroSmart Pentra slim CPU is your best choice! Available with 24V DC power, this controller has all the functionalities you need in 16 and 32 I/O configurations. Each 16 I/O CPU is equipped with eight DC inputs, two transistor outputs (sink or source) and six relay outputs, while the 32 I/O CPU is equipped with 16 DC inputs and 16 transistor outputs (sink or source).



## All-in-One CPU

Available with 12V DC, 24V DC and 100-240V AC power, you can choose from 10, 16 and 24 I/O configurations. The 10 I/O CPU is equipped with six DC inputs and four relay outputs, while the 16 I/O CPU is equipped with nine DC inputs and seven relay outputs. The 24 I/O CPU is equipped with 14 DC inputs and ten relay outputs. The 24 I/O CPU (24V DC and 100-240V AC models) can also be expanded with a maximum of four functional or discrete expansion modules.

## Communicate with Modbus Protocol

Modbus is a communications protocol, which over the years has become a standard in the automation industry. The main reasons for the extensive use of Modbus over other communications protocols are because it is:

1. Openly published and royalty-free
2. A relatively easy industrial network to deploy
3. Able to move raw bits or word data without placing many restrictions on vendors

Modbus is often used to connect a supervisory computer with a remote terminal unit (RTU) in supervisory control and data acquisition (SCADA) systems. All IDEC MicroSmart Pentra PLCs support Modbus protocol.

Using intuitive WindLDR software, you can configure the MicroSmart Pentra to be a Master or Slave device on a Modbus network. All MicroSmart Pentra PLCs support Modbus RTU/ASCII protocols and our CPU with embedded Ethernet port also supports Modbus TCP protocol.

## Modbus Connectivity with TCP, RTU and ASCII

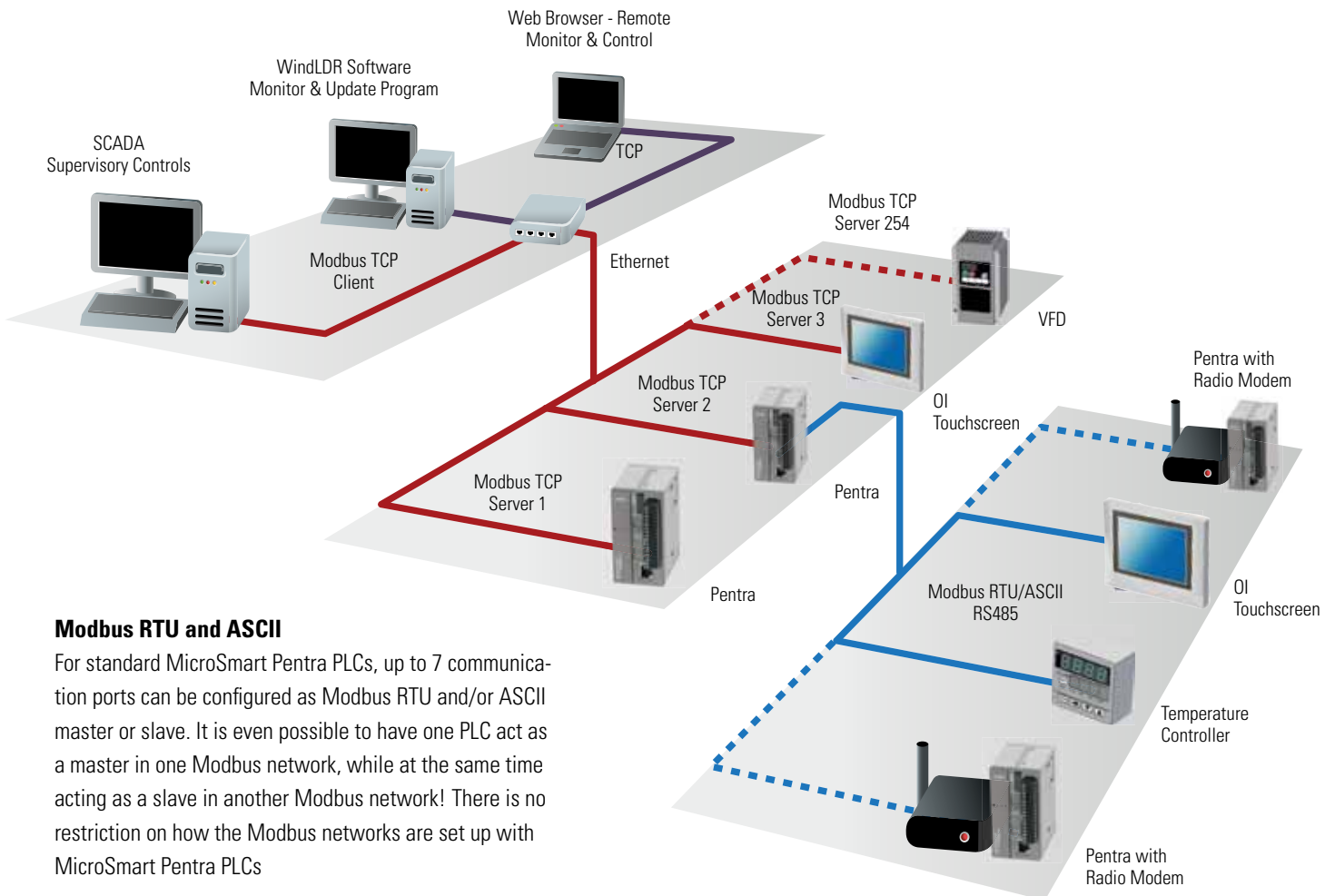

### Modbus RTU and ASCII

For standard MicroSmart Pentra PLCs, up to 7 communication ports can be configured as Modbus RTU and/or ASCII master or slave. It is even possible to have one PLC act as a master in one Modbus network, while at the same time acting as a slave in another Modbus network! There is no restriction on how the Modbus networks are set up with MicroSmart Pentra PLCs

### Modbus TCP

MicroSmart Pentra PLCs with embedded Ethernet port support Modbus TCP Client (Master) or Server (Slave) communications. When the MicroSmart Pentra is configured as a client (master) on the Modbus TCP network, up to 3 connections can be established. Each master can send up to 255 requests to the slaves. On top of that, you can make connections to the PLC using WindLDR software for program monitoring, upload or download. You can also use a web browser for remote access to the PLC, even though the Ethernet port is already configured for Modbus TCP connections.

*"Seamless communication between all my devices is a big deal. And it doesn't get easier than with a Pentra controller!"*  
 – System Integrator

## Built-in Ethernet for fast, reliable connectivity



Ethernet is the fastest growing segment of industrial networking, allowing reliable access-from-anywhere capability and easy remote-data archiving. It makes sense: you can't always be in the same location as your machinery, but with IDEC MicroSmart Pentra PLCs, you don't need to be. Now you can monitor status in real-time, receive email alerts and customize your own web pages.

MicroSmart Pentra PLC with embedded Ethernet  
With an easy-to-configure, built-in Ethernet port, you can set up your systems for remote access in no time.

### Remote Access and Control

With this latest model, you can configure the MicroSmart Pentra PLC for remote monitoring and control. Using WindLDR software, you can remotely monitor or update the PLC programs without having to be near the PLC.

### Web Server Functions

Using standard web browsers like Internet Explorer or Firefox, you can remotely log-in and access web pages that are stored directly on the MicroSmart Pentra PLC. Up to 1 MB of memory is dedicated for web page storage! Use the built-in web pages or create your own using an HTML editor.

### Ping Functions

A new PING instruction, available in the MicroSmart Pentra PLCs with embedded Ethernet, allows the PLC to ping other PLCs or devices on a network to verify if that device is active or offline. It's a great way to make sure all your systems are working.



## Up to 14 Simultaneous Connections

Using Maintenance Communication Server connections, up to 3 Client devices, such as an OI touchscreen, WindLDR software and SCADA OPC server such as WindSRV (KepServerEx), can simultaneously communicate with your MicroSmart Pentra PLC. Using Server Connections, an additional 8 connections can be established and each connection can be defined as Maintenance, User Communication or Modbus TCP server protocol. On top of that, another 3 connections can be configured as Modbus TCP client protocol, with a maximum of 255 requests. Each request can be for different slave devices with different IP addresses on the network.

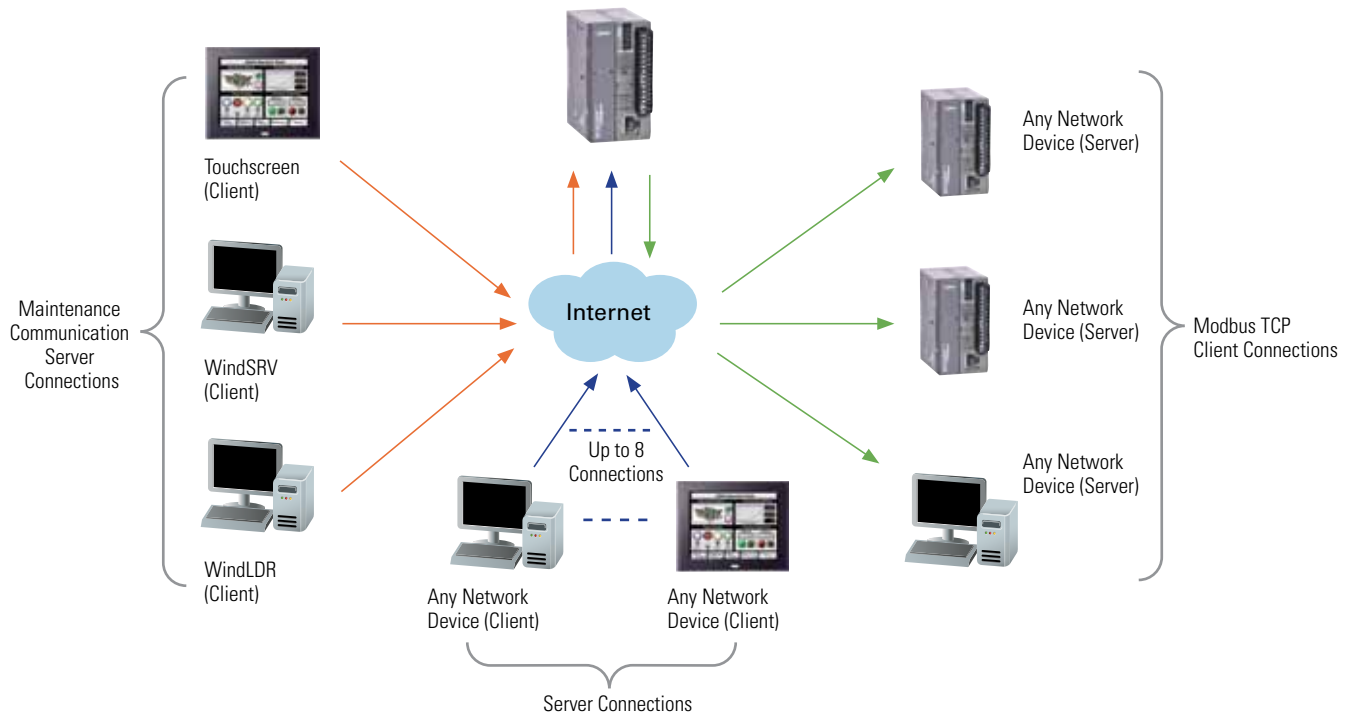

### Instant Email and Text Alerts

Never have to worry that you will be out of touch with your control system. MicroSmart Pentra PLCs have the ability to send email or text messages to your inbox and mobile phone. You can instantly be notified if any abnormal conditions occur. Or simply have the PLC configure and send daily operational status updates. Not only can static information with up to 1,500 characters be sent in one message, but data register values can be incorporated as well.

A new EMAIL instruction is now available in WindLDR software. You can program as many EMAIL instructions as you prefer as long as you don't exceed the programming memory capacity. A total of 255 email messages can be configured in each PLC. Each email message can be sent to multiple recipients. That means you can have as many people receive the email as required! MicroSmart Pentra PLCs also support email login authentication, which requires each sender to be verified by a username and password.

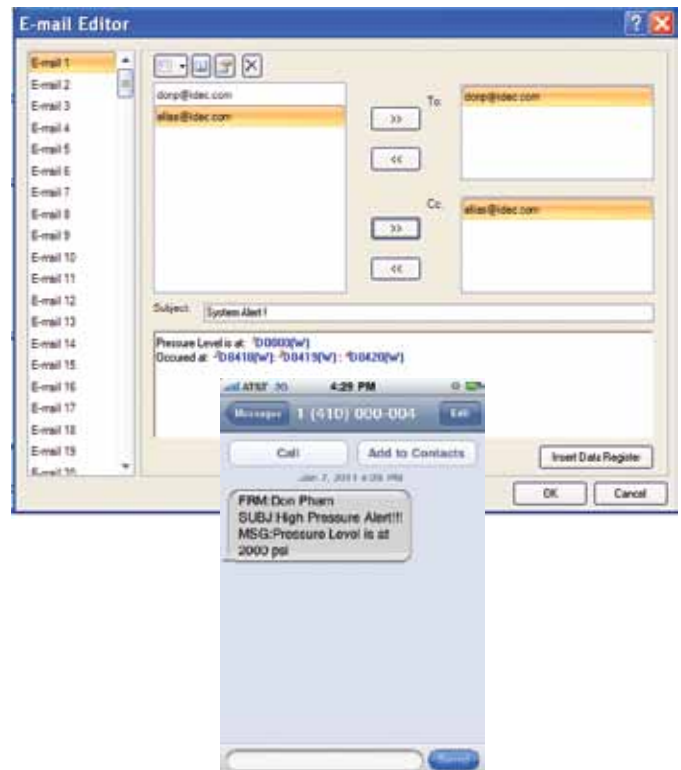

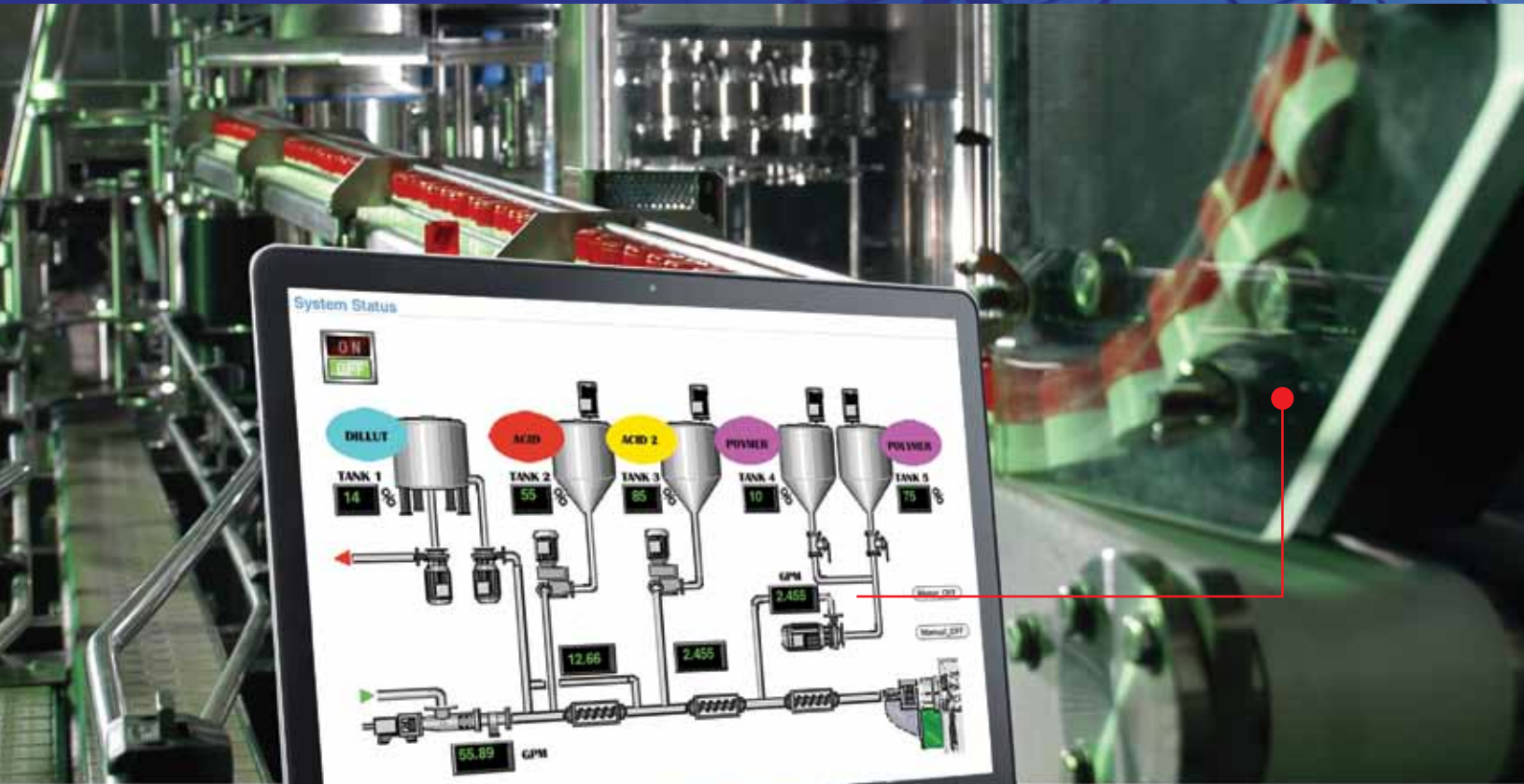

## Customize critical data for quick online monitoring

Using the MicroSmart Pentra PLC with embedded Ethernet, you have the ability to design and create your own web page. Using a standard web browser, such as Internet Explorer or Firefox, critical information in the PLC can be accessed and controlled remotely over the web. Up to 1MB of memory is reserved for web server functions.

With your web page, data is easy to access and read. Your web page can display important parameters such as flow

rate, pressure, temperature, speed etc, of your system. These parameters can then be remotely monitored and updated. Need to change and update set points, no problem!

Using any standard HTML editor; design and create your own web pages and then import these files to the WindLDR software. WindLDR will download the HTML files to the embedded Ethernet MicroSmart Pentra CPU. It's that simple! Design it the way you want.

*"With MicroSmart Pentra, I can check on our assembly lines right from the office, no matter where they're located. Makes my life a whole lot easier!" – Production Manager*



# Cellular modems let you connect anywhere

If your system is located in a remote, unpopulated area where a simple internet connection isn't available, monitoring equipment spread across a large geographic region can be difficult. Usually someone must drive to each location to manually monitor critical information, which is both time consuming and costly. So what do you do if an internet connection isn't available where your system is installed? A GSM/CDMA wireless modem lets you access your system remotely through mobile carriers in the GSM/CDMA network.

MicroSmart Pentra PLCs have been installed in various applications where they provide seamless communications through a third party GSM/CDMA cellular modem and its network. Data can then be streamed from the PLC to your servers or central office. Critical information can be remotely accessed 24/7, even in systems deployed in remote and unpopulated areas where internet service is not accessible.

- Reliable cellular connections
- 24/7 monitoring
- Alarms and system status alerts
- Remote updating for PLC programs

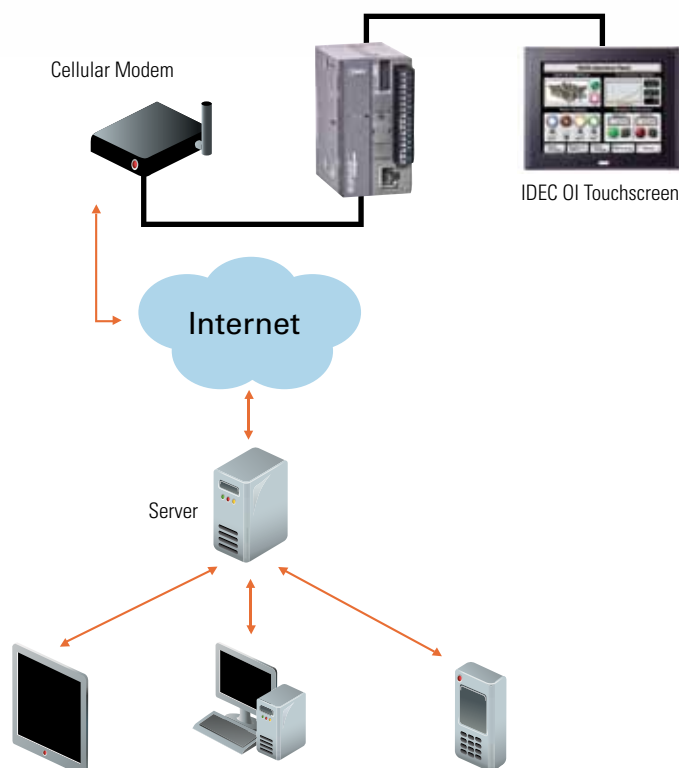

# Connect your devices by expanding to 7 ports

Just imagine all the possibilities you will experience with the flexibility of a powerful MicroSmart Pentra Slim PLC. You can configure and seamlessly communicate with as many as 7 serial devices via RS232C or RS485. MicroSmart Pentra PLCs are the only micro PLC in the market to combine so much power and flexibility in one controller.

## Communicate to any device

With MicroSmart Pentra PLCs, you don't have to worry about limited communication capabilities. It doesn't matter if you're just starting out or a current user expanding your MicroSmart Pentra PLC, you can rest assured that these communication modules will provide reliable and seamless communication. If RS485 modules are used for all six ports, up to 186 RS485 slave devices can be connected with as high as a 115K baud rate available for fast transmission.

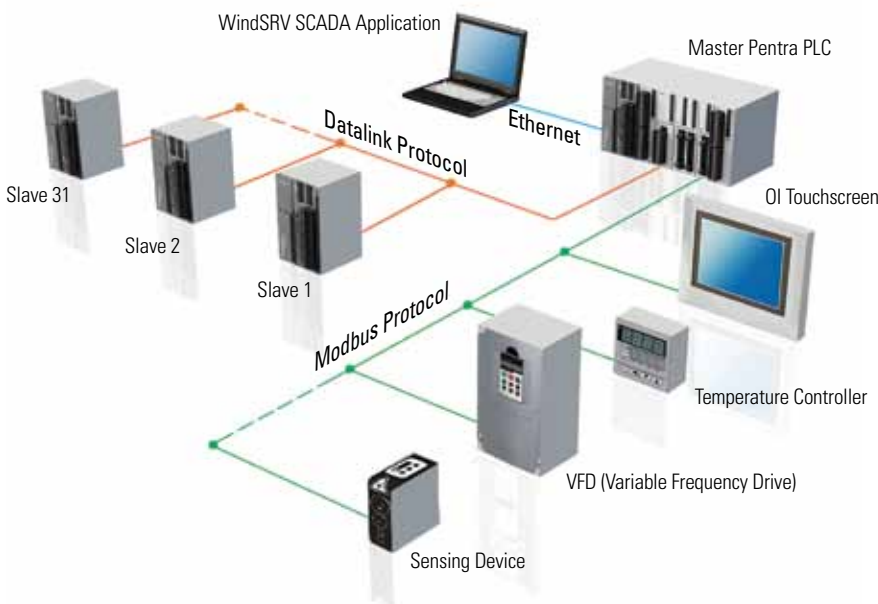

## Multiple networks of Modbus protocols

IDEC MicroSmart PLCs can support Modbus communication protocol and each of the seven communication ports support Modbus protocol. You can configure one port to talk Modbus RTU master, another port for Modbus RTU slave, and more.

## Network thousands of I/Os

Using IDEC Datalink and/or Modbus protocol, you can configure tens of thousands of I/Os with one MicroSmart Pentra PLC.

# Boost the speed of productivity

The success of your system might be dependent on a few milliseconds. Many micro controllers lack the necessary tools for accuracy at any speed, much less at the high speeds modern applications require. MicroSmart PLCs have always had the capability to operate high speed inputs and outputs, but MicroSmart Pentra PLCs can go even faster, up to 100 kHz – and so can your productivity.

## High-speed inputs

- Four high-speed inputs with a maximum frequency of 100 kHz
- Supports single/dual phase inputs for rotary encoders
- 32-bit counting range up to 4,294,967,295 pulses
- Integrated Functions
  - Execute Interrupt Programs
  - Frequency Measurement
  - High Speed Counter Refresh
  - Multi Stage Comparison

## High-speed outputs

Configure as many as three high speed pulse outputs, up to 100 kHz, and get the simple control you want for stepper or servo motors.



# Connect up to 56 analog devices



Process controls play an important part in industrial machines. Analog signals such as pressure transducers, float switches, flow meters, valves, temperature, analog sensors and more, need to be correctly analyzed and controlled. MicroSmart Penra PLCs offer a wide range of solutions, including 0-10V DC, 4-20 mA, resistance thermometer (RTD), thermistor and thermocouple inputs, and -10 to 10V DC and 4-20 mA outputs. Analog modules are available in 12 or 16-bit resolution, providing a precise reading and fast throughput.

## Expand to 56 Analog I/O

7 analog I/O expansion modules can be configured on MicroSmart Penra PLCs. That's a total of 56 analog channels that you can utilize!

Part Number	I/O Points	Input	Output	Resolution
FC4A-J8C1	8 (8 inputs)	-	-	16-bit (0-50,000)
FC4A-L03A1	3 (2 inputs, 1 output)	0-10 VDC, 4-20 mA	0-10 VDC, 4-20 mA	12-bit (0-4095)
FC4A-J2A1	2 (2 inputs)	-	-	-
FC4A-J4CN1	4 (4 inputs)	0-10 VDC, 4-20 mA, RTD, Thermocouple	-	16-bit (0-50,000)
FC4A-L03AP1	3 (2 inputs, 1 output)	RTD, Thermocouple	0-10 VDC, 4-20 mA	12-bit (0-4095)
FC4A-J8AT1	8 (8 inputs)	Thermistor (NTC/PTC)	-	12-bit (0-4000)
FC4A-K4A1	4 (4 outputs)	-	0-10 VDC, 4-20 mA	12-bit (0-4095)
FC4A-K2C1	2 (2 outputs)	-	-10 to 10 VDC, 4-20 mA	16-bit (0-50,000)
FC4A-K1A1	1 (1 output)	-	0-10 VDC, 4-20 mA	12-bit (0-4095)

Choose from a wide range of available modules.

## Revolutionary universal input module

IDEA also offers a universal analog input module. This 4-pt universal analog input module can accept any of the following types of analog signals: 4-20 mA, 0-10V DC, RTD and type J, K or T thermocouple!

## Easy to Configure and Scale

Setting up analog modules in your PLC system should not be a challenge. Using our analog setting macro instruction in WindLDR software, you can easily set up and scale your analog signals in no time at all.

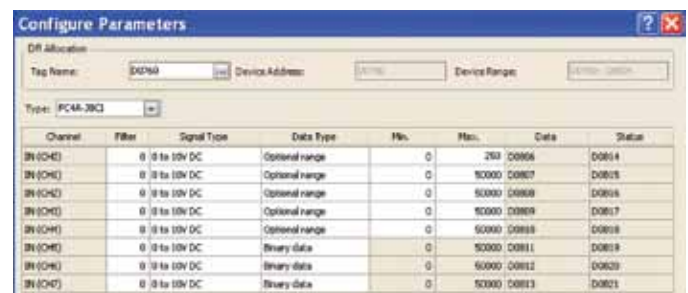

Modules are easy to configure using WindLDR software.

# Advanced PID for precision control

PID (Proportional Integral Derivative) is the most commonly used feedback control loop in industrial control systems. PID calculates an error value as the difference between a measured process variable and a desired set point. The controller then attempts to minimize the error by adjusting the process control. With MicroSmart Pentra PLCs, PID implementation can be deployed in two ways: integrated PID controls or a dedicated Process Control module, which can be mounted on the MicroSmart Pentra expansion bus.

## Integrated PID Controls

Using built-in PID functions in the MicroSmart Pentra PLCs, and in conjunction with analog I/O expansion modules, a maximum of 56 PID loops can be programmed. A PID Macro instruction in WindLDR software is also available to guide you through the process of setting up and tuning the P, I and D parameters. You can also select from various control modes including Auto-tuning, Advanced Auto-tuning or Manual.

## Advanced PID Control Module

A dedicated PID Control module is available for extreme stability and complex applications. This particular module has more functionalities than you will find in any other controller on the market. Independent of CPU scan time, the PID Control module does the work, reducing PLC scan time without taking up PLC memory space.

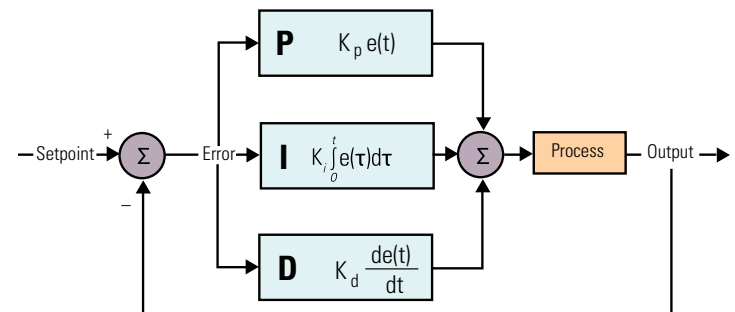

### PID Control Module Highlights:

- Precise, stable and accurate PID control with less than a 0.2% error
- Available in two models:
  - Built-in 2 analog inputs, 2 x 4-20mA/ non-contact voltage for SSR drive
  - Built-in 2 analog inputs, 2 x relay outputs
- Each input individually configured to accept different signal types
- Up to seven modules can be mounted on the MicroSmart Pentra
- Maximum 14 PID loops with auto-tuning
- 14-bit resolution
- ARW (anti-reset windup)
- Accepts many different input types including:
  - Type K, J, R, S, B, E, T, C, PL-II and N thermocouples
  - RTD
  - 0-20 mA and 4-20 mA
  - 0-1V, 0-5V, 1-5V, and 0-10V DC
- Numerous control methods including:
  - Cascade
  - External set point
  - Heating and cooling control action
  - Difference input control



## Solar ready 12V DC models

With abundant features and unparalleled performance, 12V DC MicroSmart Pentra PLCs are the perfect choice for solar applications, including traffic signs, light controls, road sign controls, remote pumping and injections systems for oil and gas industries, remote water pumping stations and solar tracking systems. For mobile applications, these PLCs can be employed in utility vehicles such as cement mixers, lift controls for the handicapped, lighting and even designation signs for vans and buses.

*"12V DC MicroSmart controllers are compact enough to fit in a tight space, while providing the controls I need." – System Engineer*







## Meets rigorous maritime standards

IDEC MicroSmart Pentra PLCs are one of the few PLCs in the market approved for maritime applications. Our PLCs are widely used in both marine and offshore applications.

We are dedicated to ensuring the safety of life and property at sea. Our MicroSmart Pentra PLCs are trusted and approved by leading maritime classification agencies, such as the American Bureau of Shipping (ABS Type Approval), DNV, and Lloyd's Register\*.

MicroSmart Pentra PLCs are the perfect solution for all your maritime applications! The MicroSmart Pentra PLC combines power and ease-of-use to give you a simple and flexible programming concept that can be tailored to your specific application.

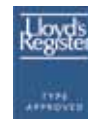

*\*Not applicable for all models. Visit [www.IDEC.com/approvals](http://www.IDEC.com/approvals) for details.*

# A fast and flawless OPC solution

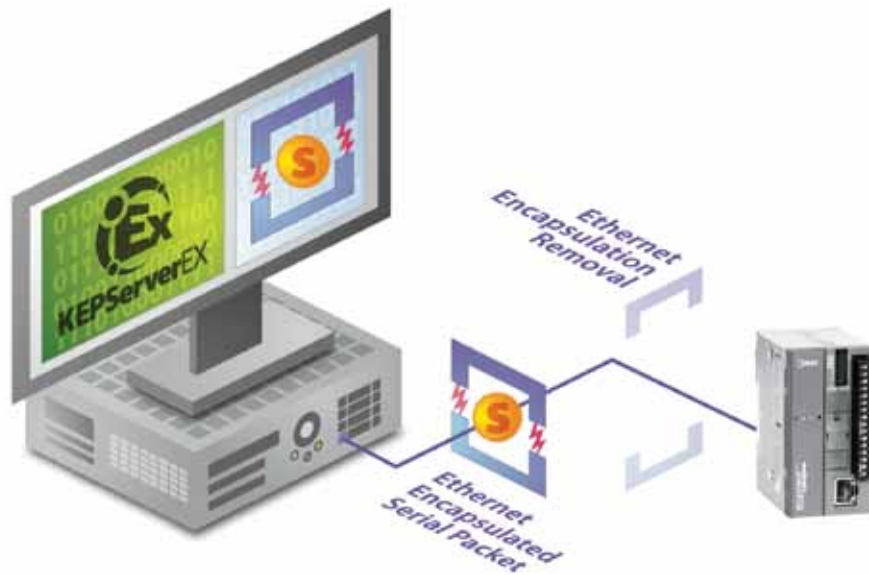

Want your control systems centralized, easy-to-manage and able to take advantage of the components you already have? WindSRV, also known as KEPServerEX, is an OPC server that provides direct connectivity between client applications and IDEC MicroSmart Pentra PLCs. It's a true plug-and-play OPC Server with effortless data management, acquisition, monitoring and control. Plus it supports complete addressing, including 32-bit data and floating point data.

## Industrial strength, easy to use OPC Server

The intuitive interface makes connecting IDEC MicroSmart Pentra PLCs so easy that within minutes you can be providing data to your application. KEPServerEX maximizes the promise of OPC through the use of a single server interface, ensuring:

- Shorter product learning curves
- Reduced system training and maintenance costs
- Improved network reliability

## Control at your fingertips

A maximum of 100 MicroSmart/MicroSmart Pentra PLCs can be connected. Imagine having the ability to centrally monitor and control your whole plant, at your fingertips.

## Quick Client

Using Quick Client, you can access all data available to the server application, including System, Diagnostic- and User-defined tags. After you've created a simple KEPServerEX project, auto launch Quick Client from the server toolbar to test your device connection.

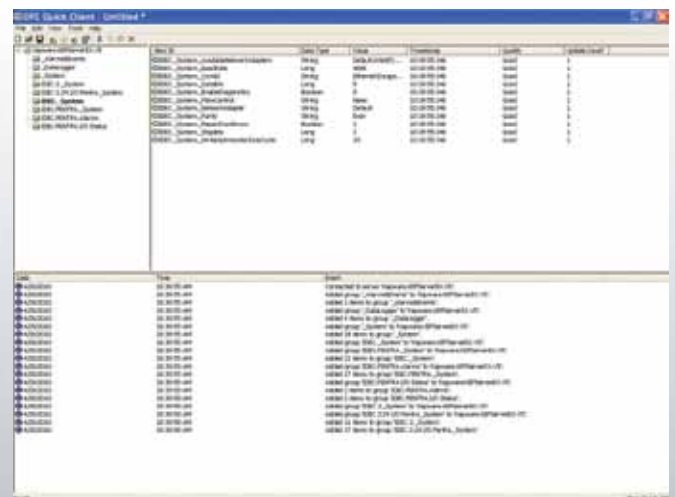

# Fastest micro PLC in its class



## Fast Processing Speed

MicroSmart Pentra Slim CPU is the fastest PLC in its class. In fact, the overall processing speed of our new Logic Engine CPU is 16 times faster than our competitor's average controller for simple instruction execution, and more than 14 times faster when executing advanced instruction sets.

## USB Maintenance Port

The new MicroSmart Pentra PLC with an embedded Ethernet PLC port also has an embedded mini-B USB port for maintenance. You can now easily connect your PC to this PLC using a standard USB cable.

## Expanded Memory

You won't run out of program memory space with our MicroSmart Pentra PLCs. The slim type CPU supports up to 62K bytes (10,400 steps) of programming memory. And if that's still not enough for your applications, a new optional memory cartridge for the embedded Ethernet PLC is now available with 128K bytes (21,300 ladder steps). MicroSmart Pentra is also equipped with:

- 48,000 Data Registers
- 2,048 Internal Relays
- 256 Timers
- 256 Counters

## FREE Upgradeable Firmware

MicroSmart Pentra PLCs can keep up with your always expanding applications. This is thanks to field upgradeable firmware that allows you to upgrade and download system firmware as needed. And you never have to worry new features and functions won't be compatible with your MicroSmart Pentra PLC. The newest firmware is always available when you download our most recent version of Automation Organizer suite. Upgrades are always free to our users.

## Comments and Tags download

With up to 128K bytes of programming memory, you are free to load as much information into the PLC as you like. All comments and tag identification can be downloaded and will reside in the PLC for better understanding and clarification. No other micro PLC can offer this much programming memory and more importantly, flexibility.

MicroSmart Pentra Slim CPU Speed Comparison (µsecs)

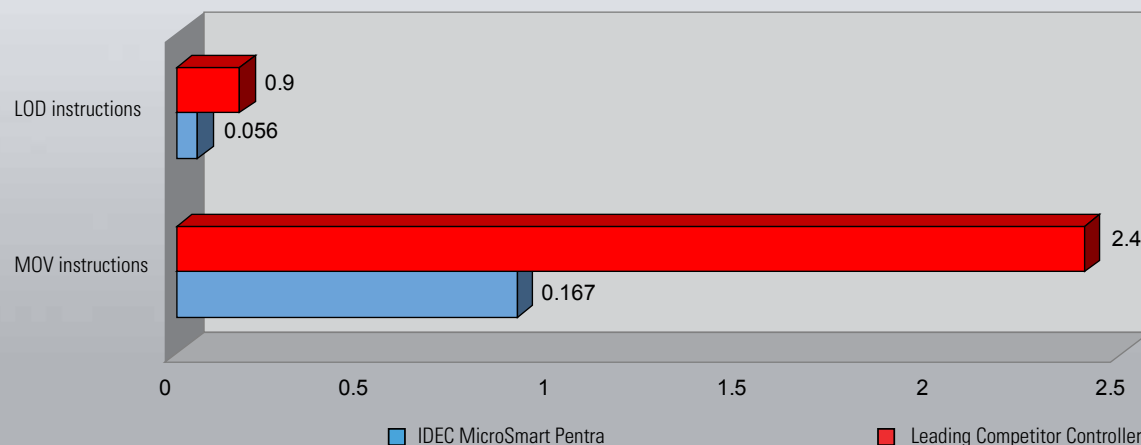

# Automation Organizer lets you design, debug and document

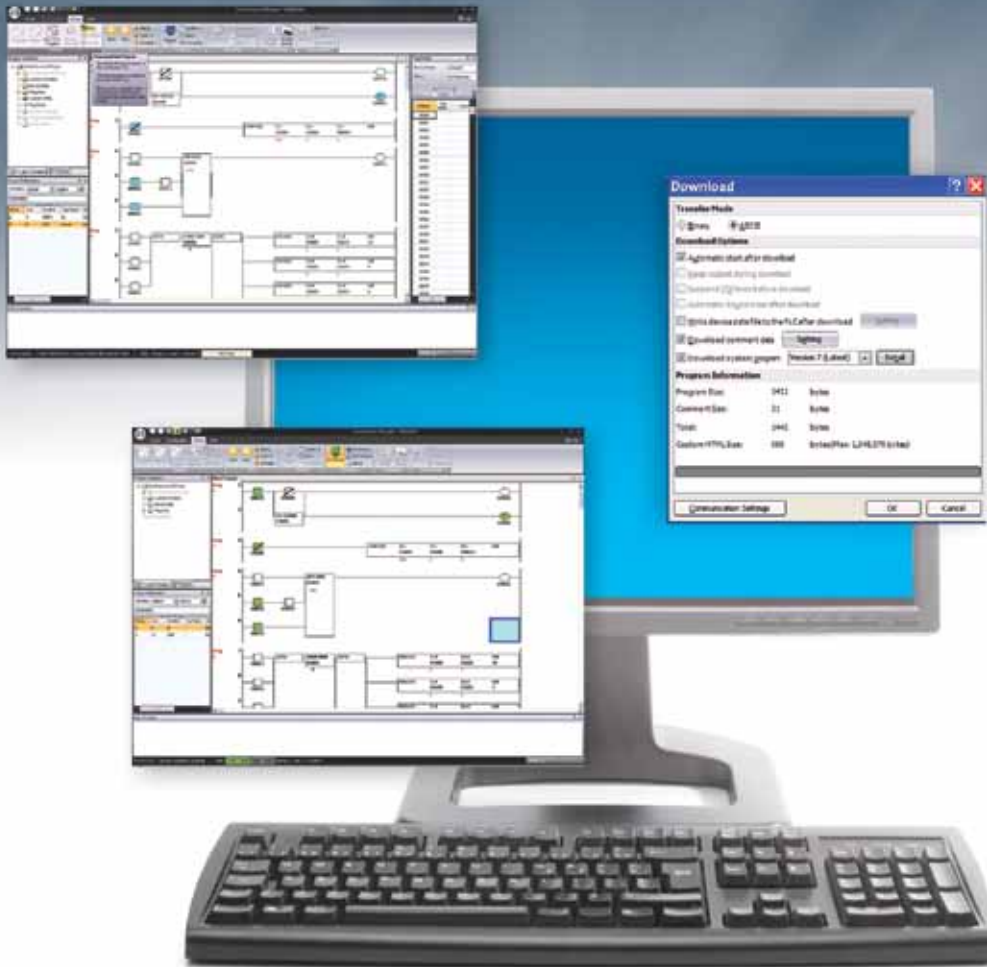

Automation Organizer (AO) is a powerful software suite containing PLC programming software (WindLDR), OI touchscreen configuration software (WindO/I-NV2) and system configuration software (WindCFG). AO boasts a completely new graphic user interface and redesigned menu icons. AO is a one-stop automation software package for IDEC MicroSmart Pentra PLCs and IDEC OI touchscreens, and is compatible with Windows XP, Vista (32 bit) and Windows 7 (32 and 64-bit).

## **FREE Upgrades**

The Automation Organizer suite comes with free lifetime upgrades. Once you make the initial purchase, upgrades are absolutely free.

*“AO just makes sense. It’s the little things like a common tag name database for both my PLC and HMI controls.”*

*– System Engineer*



## Automation Organizer WindLDR

All IDEC MicroSmart Pentra PLCs are programmable with WindLDR ladder logic software. This icon-driven programming tool combines logic and intuition with an incredibly easy-to-use interface to allow you to take advantage of MicroSmart features. Even without ladder program experience, you can use the built-in editors, shortcuts and debuggers to configure programs. WindLDR is an excellent, long-term investment for your control solutions.

### Simulation Mode

WindLDR allows you to simulate ladder programs with built-in Simulation mode. You can easily test and verify functionality of your ladder program without actual hardware.

### Online Editing

Shutting down your PLC for minor changes can be a major hassle, so WindLDR allows you to edit and download programs without interrupting PLC operation. You can write new values to counters, timers and registers at any time without switching between editor mode (for programming) and monitor mode.

### Firmware Download

With WindLDR version 6.4 or later, you have the option to upgrade or downgrade your CPU system program. It's as simple as clicking on the checkbox in the Download dialog box. Now you can easily update your PLC system firmware with the click of a button.



## Automation Organizer WindO/I-NV2

WindO/I-NV2 software is the programming tool available for all IDEC OI touchscreens. It is used to create projects or programs that can display information from a PLC, process status, or can be used to input data with virtual switches or keypads to make changes to a process. The objects are extremely easy to configure with the help of step-by-step navigation. It lets you quickly create colorful graphical screens in no time using drop-down menus and intuitive drag and drop functionality for the objects. A workspace is available to help you organize and manage projects, objects and screens.



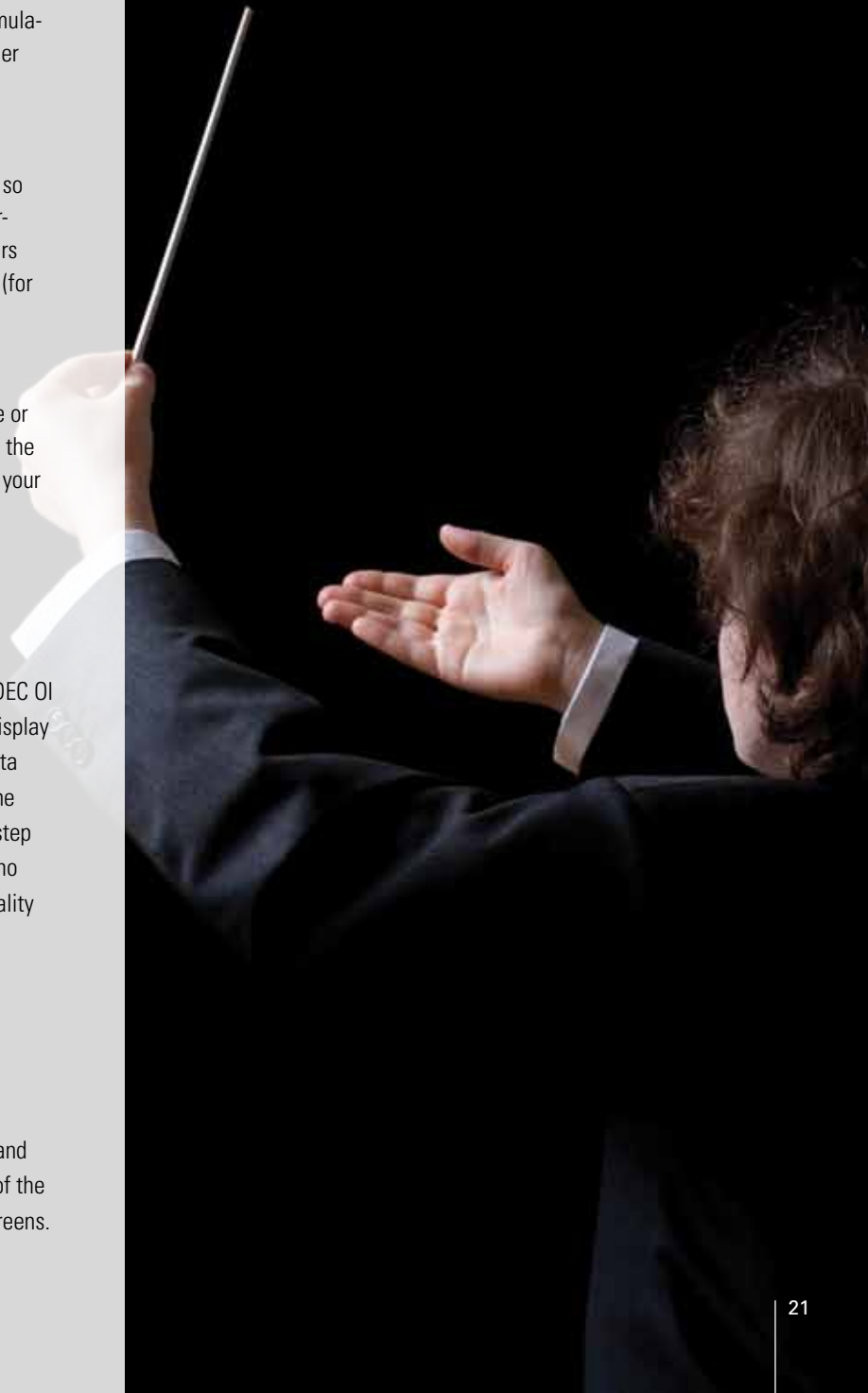

## Automation Organizer WindCFG

WindCFG is a system layout and configuration tool for IDEC PLCs and OI touchscreens. Using WindCFG, you can create a visual layout of the system design and basic configuration of your PLC and OI touchscreens.



## Part Numbers

### Slim CPUs

Appearance	Part Number	Embedded I/Os	Operating Voltage	Ethernet & USB Port	Output	Maximum No. of Expansion Modules				
	FC5A-D12K1E	12 (8in/4out)	24V DC	Yes	Transistor Sink	15				
	FC5A-D12S1E				Transistor Source					
	FC5A-D16RK1	16 (8in/8out)		24V DC	—		6 Relays, 2 Trans. Sink	15		
	FC5A-D16RS1						6 Relays, 2 Trans. Source			
	FC5A-D32K3	32 (16in/16out)			24V DC		—		Transistor Sink	15
	FC5A-D32S3								Transistor Source	

### All-in-One CPUs

Appearance	Part Number	Embedded I/Os	Operating Voltage	Ethernet & USB Port	Output	Maximum No. of Expansion Modules
	FC5A-C10R2	10 (6in/4out)	120-240V AC	—	Relay	—
	FC5A-C10R2C		24V DC			
	FC5A-C10R2D		12V DC			
	FC5A-C16R2	16 (9in/7out)	120-240V AC	—	Relay	—
	FC5A-C16R2C		24V DC			
	FC5A-C16R2D		12V DC			
	FC5A-C24R2	24 (14in/10out)	120-240V AC	—	Relay	4
	FC5A-C24R2C		24V DC			
	FC5A-C24R2D		12V DC			

### Discrete Expansion Modules

Appearance	Part Number	Input	Output	I/O Points	Connection Type		
	FC4A-N08A11	100-120V AC	-	8 Inputs	Removable Screw Terminal		
	FC4A-N08B1	24V DC		-		16 Inputs	MIL Connector
	FC4A-N16B1					32 Inputs	
	FC4A-N16B3						
	FC4A-N32B3						
	FC4A-R081				Relay	8 Outputs	Removable Screw Terminal
	FC4A-R161	16 Outputs					
	FC4A-T08K1	8 Outputs	MIL Connector				
	FC4A-T08S1	Transistor Sink					
	FC4A-T16K3			Transistor Source			
	FC4A-T16S3	16 Outputs					
	FC4A-T32K3	Transistor Sink		32 Outputs			
	FC4A-T32S3					Transistor Source	
	FC4A-M08BR1	24V DC	Relay	8 (4in/4out)		Removable Screw Terminal	
	FC4A-M24BR2	24V DC	Relay	24 (16in/8out)		Spring Clamp	

### Analog Expansion Modules

Appearance	Part Number	Input	Output	I/O Points	Resolution
	FC4A-J8C1	0-10V DC, 4-20mA	-	8 (8 inputs)	16-bit (0-50,000)
	FC4A-L03A1		0-10V DC, 4-20mA	3 (2 inputs, 1 output)	12-bit (0-4095)
	FC4A-J2A1		-	2 (2 inputs)	
	FC4A-J4CN1	0-10V DC, 4-20mA, RTD, Thermocouple	-	4 (4 inputs)	16-bit (0-50,000)
	FC4A-L03AP1	RTD, Thermocouple	0-10V DC, 4-20mA	3 (2 inputs, 1 output)	12-bit (0-4095)
	FC4A-J8AT1	Thermistor (NTC/PTC)	-	8 (8 inputs)	12-bit (0-4000)
	FC4A-K4A1	-	0-10V DC, 4-20mA	4 (4 outputs)	12 bit (0-4095)
	FC4A-K2C1		-10 to 10V DC, 4-20mA	2 (2 outputs)	16-bit (0-50,000)
	FC4A-K1A1		0-10V DC, 4-20mA	1 (1 output)	12 bit (0-4095)

### PID Controls Modules

Appearance	Part Number	Description
	FC5A-F2M2	PID Control Module with 2x analog inputs and 2x 4-20mA/0-10V DC outputs
	FC5A-F2MR2	PID Controls Module with 2x analog inputs and 2x Relay Outputs

### Web Server Module

Appearance	Part Number	Description
	FC4A-ENET	Web Server Module (for standard CPU without Ethernet)

### AS-Interface Master Module

Appearance	Part Number	Description
	FC4A-AS62M	AS-Interface Master Communication Module



### RS232C/RS485 Communication Modules

Appearance	Part Number	Description
	FC5A-SIF4	RS485 Communication Module Configure as Port 3 to 7
	FC5A-SIF2	RS232C Communication Module Configure as Port 3 to 7



### Communication Modules for Slim CPU

Appearance	Part Number	Description
	FC4A-HPC1	RS232C Communication Module for slim CPU Configure as Port 2
	FC4A-HPC2	RS485 Communication Module for slim CPU Mini DIN type, Configure as Port 2
	FC4A-HPC3	RS485 Communication Module for slim CPU Screw Terminal type, Configure as Port 2

### Expansion Power Supply Modules

Appearance	Part Number	Description
	FC5A-EXM1M	Master expansion power supply (Use with FC5A-EXM1S slave power supply)
	FC5A-EXM1S	Slave expansion power supply (Use with FC5-EXM1M master power supply)
	FC5A-KX1C	Expansion interface cable between master and slave power supply (1m length)
	FC5A-EXM2	Expansion Interface Module

### HMI Modules

Appearance	Part Number	Description
	FC4A-HPH1	HMI base module (HMI module is not included)
	FC4A-PH1	HMI module



### MIL Connector Cables (use with Breakout Modules)

Use with	Part Number	Model	Length	
CPU Module (26-wire) BX1D-S26A, BX1D-T26A	FC9Z-H050B26	Non-shielded	1.64ft (0.5m)	
	FC9Z-H100B26		3.28ft (1m)	
	FC9Z-H200B26		6.56ft (2m)	
	FC9Z-H300B26		9.85ft (3m)	
	FC9Z-H050A26	Shielded	1.64ft (0.5m)	
	FC9Z-H100A26		3.28ft (1m)	
	FC9Z-H200A26		6.56ft (2m)	
	FC9Z-H300A26		9.85ft (3m)	
		FC9Z-H100C26A	Shielded Single Connectors	5ft (1.5m)
	I/O Expansion Modules (20-wire) BX1D-S20A, BX1D-T20A	FC9Z-H050B20	Non-shielded	1.64ft (0.5m)
FC9Z-H100B20		3.28ft (1m)		
FC9Z-H200B20		6.56ft (2m)		
FC9Z-H300B20		9.85ft (3m)		
FC9Z-H050A20		Shielded	1.64ft (0.5m)	
FC9Z-H100A20			3.28ft (1m)	
FC9Z-H200A20			6.56ft (2m)	
FC9Z-H300A20			9.85ft (3m)	
		FC9Z-H100C20A	Shielded Single Connectors	5ft (1.5m)

### Communication Adapters

Appearance	Part Number	Description
	FC4A-PC1	RS232C Communication Adapter Mini DIN type
	FC4A-PC2	RS485 Communication Adapter Mini DIN type
	FC4A-PC3	RS485 Communication Adapter Screw Terminal type



### Programming Cables

Appearance	Part Number	Description
	HG9Z-XCM2A	USB programming cable for embedded Ethernet CPU
	FC2A-KC4C	Serial programming cable
	FC4A-USB	USB to Serial converter

### Memory & Clock Cartridges

Appearance	Part Number	Description
	FC4A-PM32	32KB memory cartridge
	FC4A-PM64	64KB memory cartridge
	FC4A-PM128	128KB memory cartridge, For embedded Ethernet CPU only
	FC4A-PT1	Real-time clock cartridge

### Programming Software

Appearance	Part Number	Description
	SW1A-W1C	Automation Organizer software suite
	WINDSRV-1	OPC server software with single device connection.
	WINDSRV-4	OPC server software with four device connections.
	WINDSRV-U	OPC server software with 100 device connections.

### Breakout Modules

Use with	Part Number	Description
26-wire MIL connector cable	BX1D-S26A	26-terminal breakout module
	BX1D-T26A	26-terminal touch-down terminal breakout module
20-wire MIL connector cable	BX1D-S20A	20-terminal breakout module
	BX1D-T20A	20-terminal touch-down terminal breakout module



# Specifications

## Slim CPU

Part Number	FC5A-D12K1E FC5A-D12S1E	FC5A-D16RK1 FC5A-D16RS1	FC5A-D32K3 FC5A-D32S3
Rated Power Voltage	24V DC		
Allowable Voltage Range	20.4 to 26.4V DC (including ripple)		
Maximum Input Current	700mA (26.4V DC) *1		
Maximum Power Consumption	19W (26.4V DC) *1		
Allowable Momentary Power Interruption	10ms (at 24V DC)		
Dielectric Strength	Between power and ⚡ terminals: 500V AC, 1 minute, Between I/O and ⚡ terminals: 500V AC, 1 minute		
Insulation Resistance	Between power and ⚡ terminals: 10MΩ minimum (500V DC megger), Between I/O and ⚡ terminals: 10 MΩ minimum (500V DC megger)		
Noise Resistance	DC power terminals: 1.0 kV, 50ns to 1μs. I/O terminals (coupling clamp): 1.5 kV, 50ns to 1μs		
Inrush Current	50A maximum (24V DC)		
Power Supply Wire	UL1015, AWG22, UL1007 AWG18		
Operating Temperature	0 to 55°C		
Storage Temperature	-25 to +70°C (no freezing)		
Relative Humidity	Level RH1 (IEC61131-2), 10 to 95% (no condensation)		
Altitude	Operation: 0 to 2,000m, Transport: 0 to 3,000m		
Pollution Degree	2 (IEC60664-1)		
Corrosion Immunity	Free from corrosive gases		
Degree of Protection	IP20 (IEC60529)		
Grounding Wire	UL1015, AWG22, UL1007, AWG18		
Vibration Resistance	When mounted on a DIN rail or panel surface: 5 to 8.4 Hz amplitude 3.5 mm, 8.4 to 150 Hz acceleration 9.8 m/s <sup>2</sup> (1G), 2 hours per axis on each of three mutually perpendicular axes (IEC61131-2)		
Shock Resistance	147 m/s <sup>2</sup> (15G), 11ms duration, 3 shocks per axis on three mutually perpendicular axes (IEC61131-2)		
Weight	200g	230g	190g

\*1: CPU module + 7 I/O modules

## All-in One CPU

Part Number	FC5A-C10R2 FC5A-C10R2C FC5A-C10R2D	FC5A-C16R2 FC5A-C16R2C FC5A-C16R2D	FC5A-C24R2 FC5A-C24R2C FC5A-C24R2D
Rated Power Voltage	AC power: 100 to 240V AC, DC power type: 24V DC, 12V DC		
Allowable Voltage Range	AC power: 85 to 264V AC, 24V DC power type: 20.4 to 28.8V DC (including ripple), 12V DC type: 10.2 to 18.0V DC		
Rated Power Frequency	AC power: 50/60 Hz (47 to 63 Hz)		
Maximum Input Current	250mA (85V AC) 160mA (24V DC)	300mA (85V AC) 190mA (24V DC)	450mA (85V AC) *2 360mA (24V DC) *3
Maximum Power Consumption	AC Power		
	FC5A-C10R2/FC4A-C10R2: 30VA (264V AC), 20VA (100V AC) *4, FC5A-C16R2/FC4A-C16R2: 31VA (264 V AC), 22VA (100V AC) *4 FC5A-C24R2/FC4A-C24R2: 40VA (264V AC), 33VA (100V AC) *2		
Allowable Momentary Power Interruption	DC Power		
	FC5A-C10R2C/FC4A-C10R2C: 3.9W (24V DC) *5, FC5A-C10R2D: 2.8W (12V DC) *5, FC5A-C16R2C/FC4A-C16R2C: 4.6W (24V DC) *5 FC5A-C16R2D: 3.4W (12V DC) *5, FC5A-C24R2C/FC4A-C24R2C: 8.7W (24V DC) *3, FC5A-C24R2D: 4.2W (12V DC) *5		
Dielectric Strength	Between power and ⚡ or ⚡ terminals: 1,500V AC, 1 minute, Between I/O and ⚡ or ⚡ terminals: 1,500V AC, 1 minute		
Insulation Resistance	Between power and ⚡ or ⚡ terminals: 10MΩ minimum (500V DC megger), Between I/O and ⚡ or ⚡ terminals: 10MΩ minimum (500V DC megger)		
Noise Resistance	AC power terminals: 1.5 kV, 50ns to 1μs, DC power terminals: 1.0 kV, 50ns to 1μs, I/O terminals (coupling clamp): 1.5 kV, 50ns to 1μs		
Inrush Current	24V DC: 35A, 12V DC: 20A		24V DC: 40A, 12V DC: 20A
Power Supply Wire	UL1015 AWG22, UL1007 AWG18		
Operating Temperature	0 to 55°C		
Storage Temperature	-25 to +70°C (no freezing)		
Relative Humidity	Level RH1 (IEC61131-2), 10 to 95% (no condensation)		
Altitude	Operation: 0 to 2,000m, Transport: 0 to 3,000m		
Pollution Degree	2 (IEC60664-1)		
Corrosion Immunity	Free from corrosive gases		
Degree of Protection	IP20 (IEC60529)		
Ground	Grounding Resistance 100Ω(max.)		
Grounding Wire	UL1007, AWG16		
Vibration Resistance	When mounted on a DIN rail or panel surface: 5 to 8.4 Hz amplitude 3.5 mm, 8.4 to 150 Hz acceleration 9.8 m/s <sup>2</sup> (1G), 2 hours per axis on each of three mutually perpendicular axes (IEC61131-2)		
Shock Resistance	147 m/s <sup>2</sup> (15G), 11ms duration, 3 shocks per axis on three mutually perpendicular axes (IEC61131-2)		
Weight	AC: 230g, DC: 240g	AC: 250g, DC: 260g	AC: 305g, DC: 310g

\*2: CPU module (including 250mA sensor power) + 4 I/O modules

\*3: CPU module + 4 I/O modules

\*4: CPU module (including 250mA sensor power)

\*5: CPU module

## Slim CPU Functional Specifications

Part Number	FC5A-D12K1E FC5A-D12S1E	FC5A-D16RK1 FC5A-D16RS1	FC5A-D32K3 FC5A-D32S3				
Control System	Stored program system						
Instruction Words	42 basic, 152 advanced	42 basic, 126 advanced	42 basic, 130 advanced				
Program Capacity *1	127.8KB (21,300 steps)	62.4KB (10,400 steps)					
User Program Storage	Flash ROM (10,000 times rewritable)		EEPROM (10,000 times rewritable)				
Processing Time	Basic Instruction	83µs (1,000 steps)					
	END Processing *3	0.35ms					
Expandable I/O Modules	7 modules + additional 8 modules using the expansion interface module						
I/O Points	Input	8	Expansion: 224 Additional: 256	8	Expansion: 224 Additional: 256	16	Expansion: 224 Additional: 256
	Output	4		8		16	
Internal Relay	2,048 points						
Shift Register	256 points						
Data Register	42,000 points		42,000 points *4				
Expansion Data Register / Counter	6,000 points / 256 points						
Timer (1-sec, 100-ms, 10-ms, 1-ms)	256 points						
RAM Backup	Backup Data / Duration	Internal relay, shift register, counter, data register, expansion data register / Approx. 30 days (typical) at 25°C after backup battery fully charged					
	Battery / Charging Time	Lithium battery / Approx. 15 hours for charging from 0% to 90% of full charge					
	Battery Life / Replaceability	5 years in cycles of 9-hour charging and 15-hour discharging / Not possible to replace battery					
Self-diagnostic Function	Power failure, watchdog timer, data link connection, user program ROM sum check, timer/counter preset value sum check, user program RAM sum check, keep data, user program syntax, user program writing, CPU module, clock IC, I/O bus initialize, user program execution						
Input Filter	Without filter, 3 to 15ms (selectable in increments of 1ms)						
Catch Input/Interrupt Input	(I2 and I5) Min. turn on pulse width: 40µs max., Min. turn off pulse width: 150µs max., (I3 and I4) Min. turn on pulse width: 5µs max, Min. turn off pulse width: 5µs max.						
High-speed Counter	Max Counting Frequency & High-speed Counter Points	Total 4 points Single/two-phase selectable: 100kHz (2 points) Single-phase: 100kHz (2 points)					
	Counting Range	0 to 4,294,967,295 (32 bits)					
	Operation Mode	Rotary encoder mode and adding counter mode					
Analog Pot.	Quantity (Range)	1 point (0 to 255)					
Analog Voltage Input	Quantity	1 point					
	Input Voltage Range	0 to 10V DC					
	Input Impedance	Approx. 100kΩ					
	Data Range	0 to 255 (8 bits)					
Pulse Output	Quantity (Max. Freq.)	3 points (100kHz)	2 points (100kHz)	3 points (100kHz)			
	Ethernet Specifications	Electrical Characteristics: Complies with IEEE802.3 Transmission Speed: 10BASE-T/100BASE-TX					
Ethernet Port	Ethernet Interface	RJ45					
	User Web Page Area	1MB					
	Compliant Browser	Internet Explorer 7 and 8, Firefox 3.0					
	Protocol	Data Link Layer: IP, ARP, Network Layer: UDP, TCP, ICMP Application Layer: SMTP, DHCP, HTTP, NBNS, DNS, SNTP					
Function	See table below						
Port 1	USB mini-B (CDC class), Maintenance Communication *5		RS232C – maintenance communication, user communications, Modbus slave ASCII/RTU communication				

\*1: 1 step equals 6 bytes.

\*2: Expandable up to 62.4KB when a memory cartridge is used.

\*3: Not including expansion I/O service time, clock function processing time, data link processing time, and interrupt processing time.

\*4: Extra data registers D10000 through D49999 are enabled using WindLDR Function Area Settings, then run-time program download cannot be used.

\*5: Maintenance communication (change monitor device values, upload/download user programs, download system program).

Notes: The maximum number of relay outputs that can be turned on simultaneously is 54 including those on the CPU module.

Modem communication not possible on FC5A-D12K1E/D12S1E modules.

Options include Port 2 Communication Adapter/Module (maintenance, user and modem communication; data link; Modbus ASCII/RTU master/slave communication.), Clock Cartridge, Memory Cartridge, HMI Module

## Ethernet Port Main Features

Maintenance Communication Server	Downloading, uploading, and monitoring the user program using WindLDR via Ethernet
TCP server	8 connections maximum. Each connection can be configured as Modbus TCP server, user communication server, or maintenance communication server.
TCP Client	3 connections maximum. Each connection can be configured as Modbus TCP client or user communication client.
Acquire Current Time from SNTP Server	Timezone can be specified.
Sending Email	Send email containing data register values. Number of emails: 255, To address: 512 characters max *1, cc address: 512 characters max *1 Subject :256 characters max, Body: 1,500 characters max, Supported encoding: ASCII, ISO-2022-JP, GB2312, ISO-8859-1, UTF-8
Web Server	Monitoring PLC status and data register values using web browser. User web page area: 1 MB, Authentication: Basic Authentication, Compliant browser: Internet Explorer 7 & 8, Firefox 3
PING	Number of remote hosts can be registered: 255

\*1: If the email address length is 40 characters, 12 email addresses can be configured.

## All-in-One CPU Functional Specifications

Part Number		FC5A-C10R2 FC5A-C10R2C FC5A-C10R2D	FC5A-C16R2 FC5A-C16R2C FC5A-C16R2D	FC5A-C24R2 FC5A-C24R2C FC5A-C24R2D
Control System		Stored program system		
Instruction Words		42 basic, 103 advanced	42 basic, 103 advanced	42 basic, 115 advanced
Program Capacity *1		13.8KB (2,300 steps)	27KB (4,500 steps)	54KB (9,000 steps)
User Program Storage		EEPROM (10,000 times rewritable)		
Processing Time	Basic Instruction	1.16ms (1,000 steps)		
	END Processing *2	0.64ms		
Expandable I/O Module		—		4 modules
I/O Points	Input	6	9	14
	Output	4	7	10
		Expansion: 64 *3		
Internal Relay		2,048 points		
Shift Register		128 points		
Data Register		2,000 points		
Expansion Data Register / Counter		— / 256 points		
Timer (1-sec, 100-ms, 10-ms, 1-ms)		256 points		
RAM Backup	Backup Data / Duration	Internal relay, shift register, counter, data register / Approx. 30 days (typical) at 25°C after backup battery fully charged		
	Battery / Charging Time	Lithium battery / Approx. 15 hours for charging from 0% to 90% of full charge		
	Battery Life / Replaceability	5 years in cycles of 9-hours charging and 15-hours discharging / Not possible to replace battery		
Self-diagnostic Function		Power failure, watchdog timer, data link connection, user program EEPROM sum check, timer/counter preset value sum check, user program RAM sum check, keep data, user program syntax, user program writing, CPU module, clock IC, I/O bus initialize, user program execution		
Input Filter		Without filter, 3 to 15ms (selectable in increments of 1ms)		
Catch Input/Interrupt Input		I2 through I5, Min. turn on pulse width: 40µs max., Min. turn off pulse width: 150µs max.		
High-speed Counter	Maximum Counting Frequency & High-speed Counter Points	Total 4 points Single/two-phase selectable: 50kHz (1 point) Single-phase: 5kHz (3 points)		
	Counting Range	0 to 65,535 (16 bits)		
	Operation Mode	Rotary encoder mode and adding counter mode		
Analog Pot.	Quantity (Range)	1 point (0 to 255)		2 points (0 to 255)
Analog Voltage Input	Quantity			
	Input Voltage Range	—		
	Input Impedance	—		
	Data Range	—		
Pulse Output	Quantity	—		
	Max. Frequency	—		
Sensor Power Supply (AC Power Type Only)	Output Voltage/Current	24V DC (+10% to -15%), 250mA		
	Overload Detection	Not available		
	Isolation	Isolated from the internal circuit		
Port 1		RS232C — maintenance communication, user communications, Modbus, ASCII/RTU, slave communication		

\*1: 1 step equals 6 bytes.

\*2: Not including expansion I/O service time, clock function processing time, data link processing time, and interrupt processing time.

\*3: Expansion modules cannot be connected to FC5A-C24R2D.

Note: The maximum number of relay outputs that can be turned on simultaneously is 33 including those on the CPU module.

Options include Port 2 Communication Adapter/Module (maintenance, user and modem communication; data link; Modbus ASCII/RTU master/slave communication.), Clock Cartridge, Memory Cartridge, HMI Module



### Safety Precautions

Caution: Read the safety precautions described in the user's manual or instruction sheet to ensure correct operation.