

HS7A-DMC Magnetic Safety Switches

Key features:

- Compact size and easy positioning.
- Combination with proprietary relay modules achieves safety category 4 (EN954-1).
- Compact size (7 × 16 × 51mm)
- Positioning for installation is easy.
- Up to 36 sets can be connected.
(safety relay module: HR1S-DME)
- Degree of protection: IP67



Part Numbers

HS7A Non-contact Magnetic Interlock Switches

Contact Configuration	Cable Length	LED	Part Number	Applicable Safety Relay Module
1NO + 1NC	2m	Without	HS7A-DMC5902	HR1S-D□
		With	HS7A-DMC5912	
	5m	Without	HS7A-DMC5905	
		With	HS7A-DMC5915	
	10m	Without	HS7A-DMC59010	
		With	HS7A-DMC59110	
2NO	2m	Without	HS7A-DMC7902	HR1S-AF□
		With	HS7A-DMC7912	
	5m	Without	HS7A-DMC7905	
		With	HS7A-DMC7915	
	10m	Without	HS7A-DMC79010	
		With	HS7A-DMC79110	

Accessory

Name	Part Number
Actuator	HS9Z-ZC1



One HS9Z-ZC1 is supplied with each HS7A-DMC non-contact interlock switch.

Maximum Number of Connectable Non-contact Interlock Switches per Input of Safety Relay Module

Non-contact Interlock Switch	HS7A-DMC59□□		HS7A-DMC79□□	
	Without LED	With LED	Without LED	With LED
HR1S-D□	6	3	–	–
HR1S-AF□	–	–	6	1

The HS7A-DMC non-contact interlock switch is supplied with an HS9Z-ZC1 actuator. The contact configuration in the table above shows the contact status when the non-contact interlock switch is not activated.

HR1S Safety Relay Modules for Non-contact Interlock Switches

Safety Relay Module	Voltage	Number of Inputs	Max. Number of Connectable Non-contact Interlock Switches
HR1S-DMB□32	24V DC –20 to +20%	2	12
HR1S-DME□32		6	36
HR1S-AF□30B	24V AC –15 to +10% 50/60 Hz 24V DC –15 to +10%	1	6

Safety category 3 can be achieved when connecting two or more non-contact interlock switches per one input. When connecting multiple non-contact interlock switches (HS7A-DMC790□), use HR1S-AF51□. (HS7A-DMC791□ cannot be connected in multiple numbers.)

Overview

XW Series E-Stops

Interlock Switches

Enabling Switches

Safety Control Relays

Light Curtains

AS-Interface Safety at Work

Specifications

Applicable Standards	IEC/EN 60947-5-1 UL508 (UL listed) CSA C22.2, No. 14	
Operating Temperature	-25 to 85°C (no freezing)	
Relative Humidity	30 to 85% RH (no condensation)	
Storage Temperature	-40 to +85°C (no freezing)	
Pollution Degree	3	
Electric Shock Protection	Class II (IEC 60536)	
Degree of Protection	IP67 (IEC 60529)	
Shock Resistance	300 m/s ² (11 ms) (IEC 60068-2-7)	
Vibration Resistance	100 m/s ² (10 to 150 Hz) (IEC 60068-2-6)	
Rated Voltage (Ue)	24V DC	
Rated Current (Ie)	100 mA	
Repeat Accuracy	10% maximum	
Maximum Operating Frequency	150 Hz	
Voltage Drop	I = 10 mA	0.1V (without LED) / 2.4V (with LED)
	I = 100 mA	1V (without LED) / 4.2V (with LED)
Housing Material	PBT	
Housing Color	Red	
Cable	AWG23 × 4 Cable length: 2m, 5m, 10m	
Weight (approx.)	HS7A-DMC:	100g (cable length: 2m)
	HS9Z-ZC1:	9g

Dimensions (mm) HS7A-DMC (Non-contact Interlock Switch)

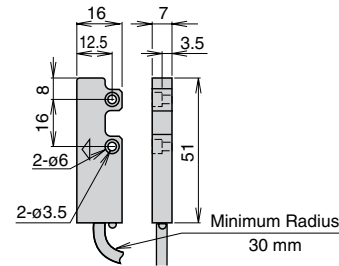

HS9Z-ZC1 (Actuator)

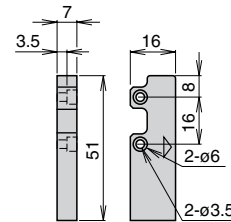

Example Wiring Diagram



The following diagrams show the contact statuses when the non-contact interlock switches are activated by the actuators.

Example: Safety Category 4 (ISO 13849-1) Circuit, HR1S-DMB + HS7A-DMC591 (1NO+1NC) + HS9Z-ZC1

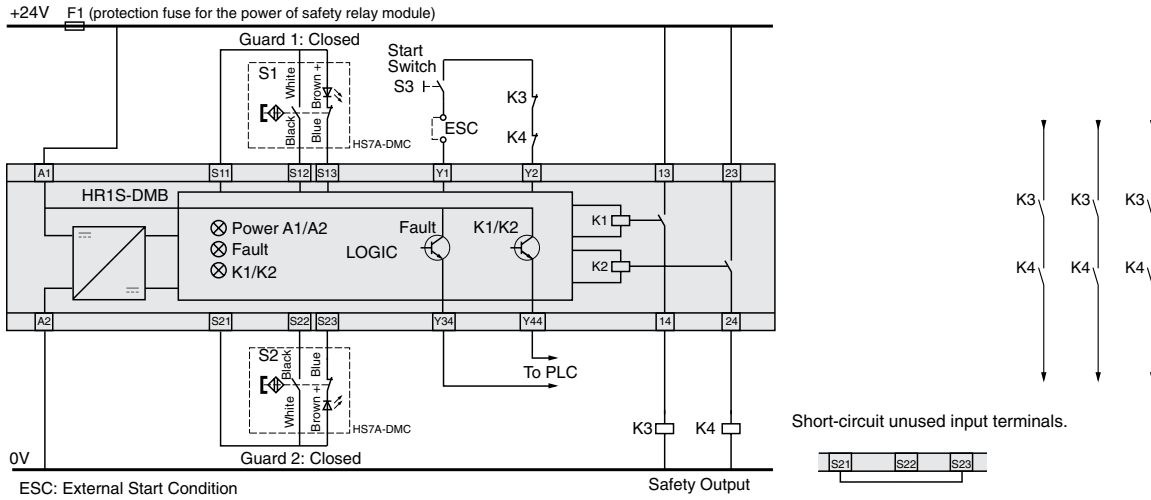

Example: Safety Category 4 (EN 13849-1) Circuit, HR1S-DME + HS7A-DMC591 (1NO+1NC) + HS9Z-ZC1

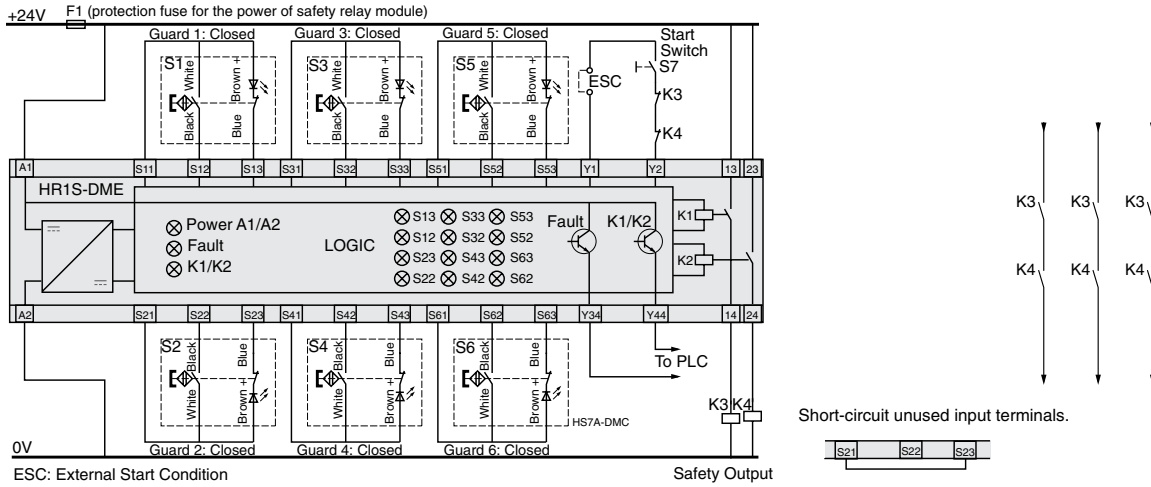

Example: Safety Category 4 (EN 13849-1) Circuit, HR1S-DMC + HS7A-DMC591 (1NO+1NC) + HS9Z-ZC1

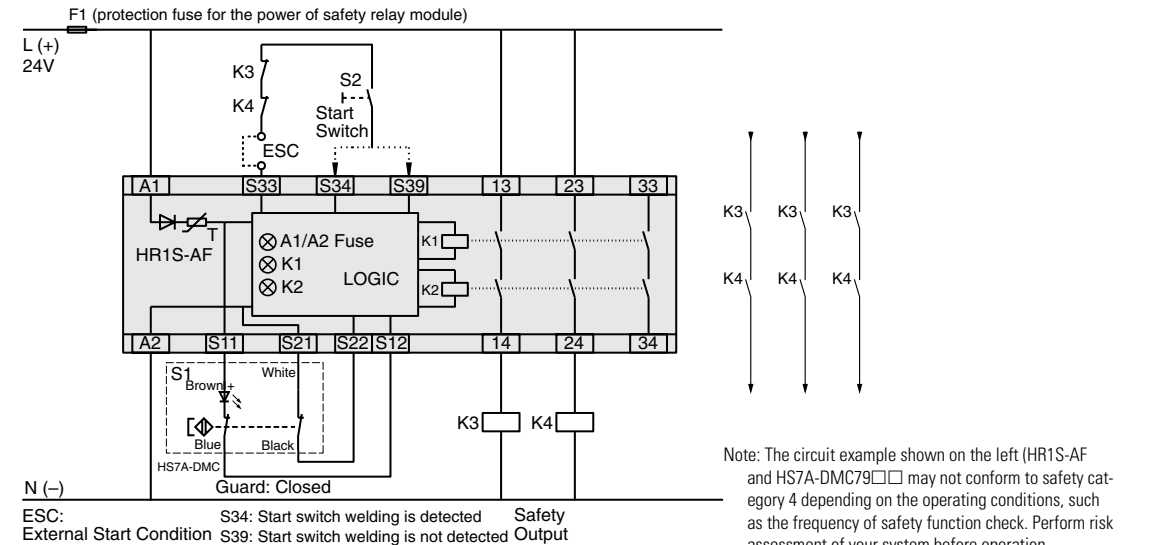

Note: The circuit example shown on the left (HR1S-AF and HS7A-DMC79) may not conform to safety category 4 depending on the operating conditions, such as the frequency of safety function check. Perform risk assessment of your system before operation.

Overview

XW Series E-Stops

Interlock Switches

Enabling Switches

Safety Control Relays

Light Curtains

AS-Interface Safety at Work

Operating Instructions

Operating Direction

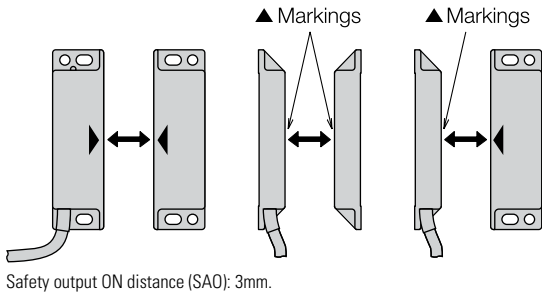

Precautions for Installation

When installing on a ferromagnet

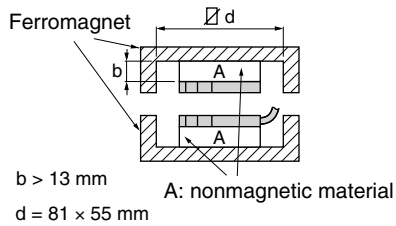

Close mounting

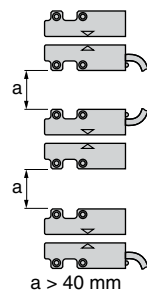

Tightening Torque

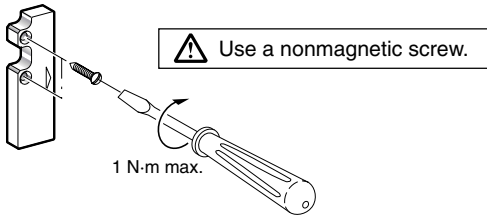

Operation Chart

HS7A-DMC59□□(1NO+1NC)

HS7A-DMC79□□(2NO)

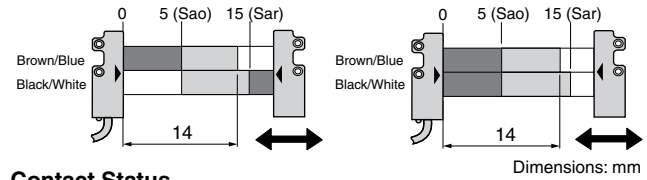

Contact Status

	Contact Closed (1)
	Contact Open (0)
	Transient State

Sao: Assured operating distance where the safety output is sure to turn on.
Sar: Assured release distance where the safety output is sure to turn off.

Note: When the transfer time between the actuator's Sao-Sar is 500 ms or longer, the time lag is detected as an error.

Operation Area

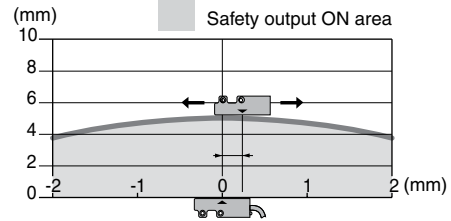

HS7A-DMP Magnetic Safety Switches

Key features:

- Three-contact models.
Auxiliary contacts enable PLCs to monitor the door status.
- Operation signals from auxiliary contacts can be read directly by controllers such as PLCs, allowing for monitoring HS7A-DMP non-contact interlock switches.
- Ideal for installation on guard doors where positioning is difficult.
- Conformable up to safety category 4 (EN ISO 13849-1)
(Combining with proprietary safety relay module achieves safety category 4.)
- A maximum of 36 sets can be connected (safety relay module: HR1S-DME)
- Degree of protection: IP67



The HS7A-DMP non-contact interlock switches can be used as interlock switches when used in combination with safety relay modules specified by IDEC.

Part Numbers

HS7A Non-contact Interlock Switches

Contact Configuration	Cable Length	LED	Ordering Type No.	Applicable Safety Relay Module
1NO+2NC	2m	Without	HS7A-DMP5002	HR1S-D□
		With	HS7A-DMP5012	
	5m	Without	HS7A-DMP5005	
		With	HS7A-DMP5015	
2NO+1NC	2m	Without	HS7A-DMP7002	HR1S-AF□
		With	HS7A-DMP7012	
	5m	Without	HS7A-DMP7005	
		With	HS7A-DMP7015	

The HS7A-DMP non-contact interlock switch is supplied with an HS9Z-ZP1 actuator. The contact configuration in the table above shows the contact status when the non-contact interlock switch is not activated.

HR1S Safety Relay Modules for Non-contact Interlock Switches

Safety Relay Module	Number of Inputs	Max. Number of Connectable Non-contact Interlock Switches
HR1S-DMB□	2	12
HR1S-DME□	6	36
HR1S-AF□	1	6

When connecting multiple non-contact interlock switches (HS7A-DMP700□), use HR1S-AF□. (HS7A-DMP701□ cannot be connected in multiple numbers.)

Accessory

Name	Part Number
Actuator	HS9Z-ZP1

One HS9Z-ZP1 is supplied with each HS7A-DMP non-contact interlock switch.

Maximum Number of Connectable Non-contact Interlock Switches per Input of Safety Relay Module

Non-contact Interlock Switch	HS7A-DMP50□□		HS7A-DMP70□□	
	Without LED	With LED	Without LED	With LED
HR1S-DM□	6	3	–	–
HR1S-AF□	–	–	6	1

Overview

XW Series E-Stops

Interlock Switches

Enabling Switches

Safety Control Relays

Light Curtains

AS-Interface Safety at Work

Specifications

Applicable Standards	IEC/EN 60947-5-1 UL508 (UL listed) CSA C22.2, No. 14	
Operating Temperature	-25 to 85°C (no freezing)	
Relative Humidity	35 to 85% RH (no condensation)	
Storage Temperature	-40 to +85°C (no freezing)	
Pollution Degree	3	
Electric Shock Protection	Class II (IEC 60536)	
Degree of Protection	IP67 (IEC 60529)	
Shock Resistance	300 m/s ² (11 ms) (IEC 60068-2-7)	
Vibration Resistance	100 m/s ² (10 to 150 Hz) (IEC 60068-2-6)	
Rated Voltage (Ue)	24V DC	
Rated Current (Ie)	100 mA	
Repeat Accuracy	10% maximum	
Maximum Operating Frequency	150 Hz	
Voltage Drop	I = 10 mA	0.1V (without LED) / 2.4V (with LED)
	I = 100 mA	1V (without LED) / 4.2V (with LED)
Electrical Durability	1,200,000 operations minimum	
Housing Material	PBT	
Housing Color	Red	
Cable	AWG23 × 6 Cable length: 2m, 5m	
Weight (approx.)	HS7A-DMP: 180g (cable length: 2 m) HS9Z-ZP1: 50g	

Dimensions (mm) HS7A-DMP □□□□ (Non-contact Interlock Switch)

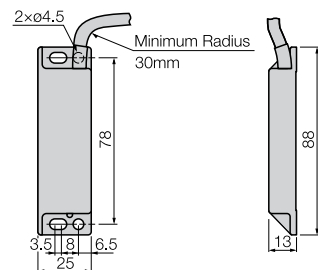

HS7A-ZP1 (Actuator)

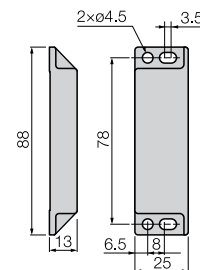

Overview

XW Series E-Stops

Interlock Switches

Enabling Switches

Safety Control Relays

Light Curtains

AS-Interface Safety at Work

Example Wiring Diagram



The following diagrams show the contact statuses when the non-contact interlock switches are activated by the actuators.

Example: Safety Category 4 (ISO 13849-1) Circuit
HR1S-DMB + HS7A-DMP50 (1N0+2NC) + HS9Z-ZP1

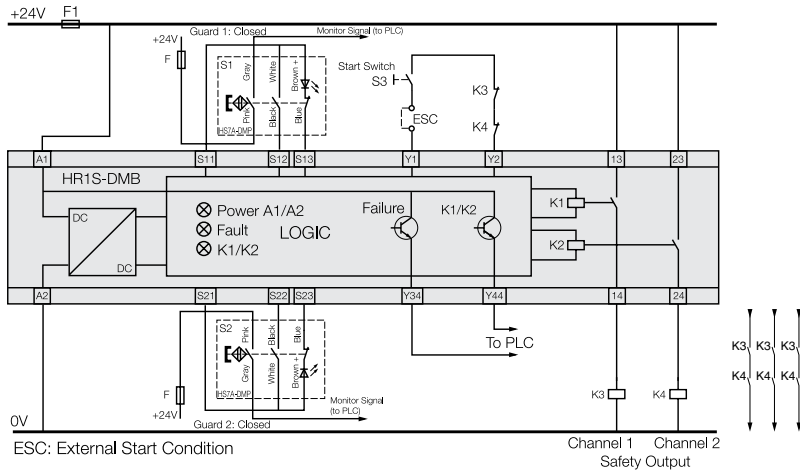

Example: Safety Category 3 (EN ISO 13849-1) Circuit
HR1S-DMB

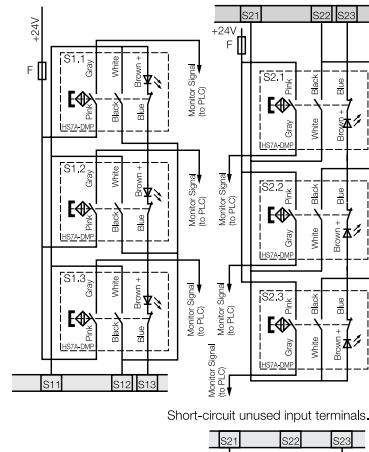

Example: Safety Category 4 (ISO 13849-1) Circuit
HR1S-DME + HS7A-DMP50 (1N0+2NC) + HS9Z-ZP1

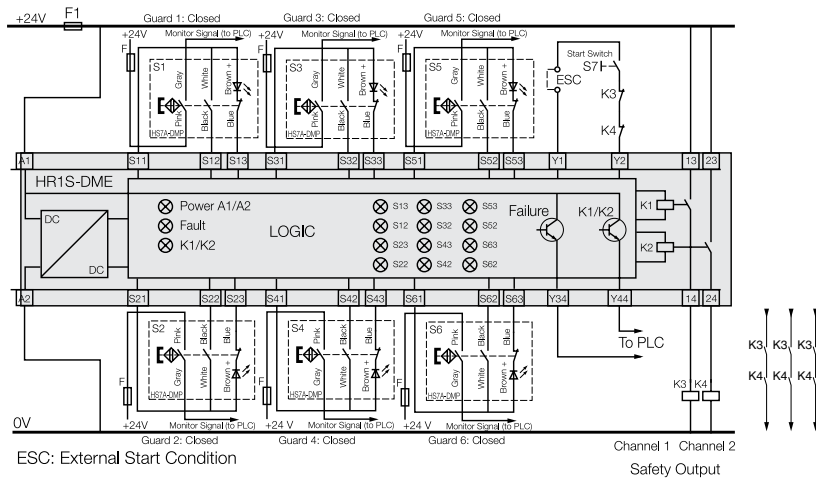

Example: Safety Category 3 (ISO 13849-1) Circuit
HR1S-DME

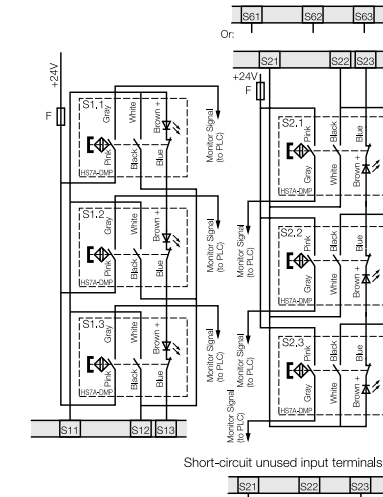

Example: Safety Category 4 (ISO 13849-1) Circuit
HR1S-AF + HS7A-DMP70 (2N0+1NC) + HS9Z-ZP1

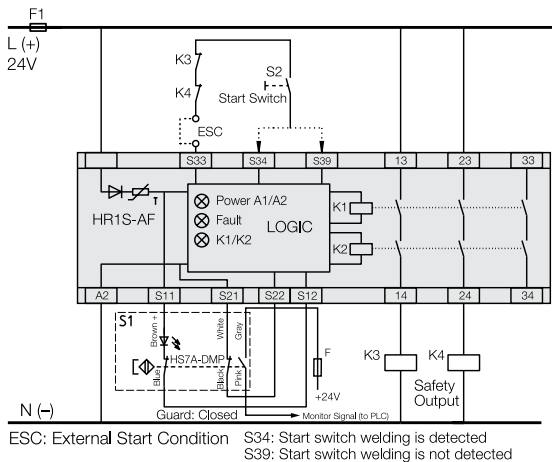

F1: Protection fuse for the power of safety relay module

F: Protection fuse for monitor signal contacts (max. 500mA gG (gL))

Note: The circuit example shown on the left (HR1S-AF and HS7A-DMP70) may not conform to safety category 4 depending on the operating conditions, such as the frequency of safety function check. Perform risk assessment of your system before operation.

Overview

XW Series E-Stops

Interlock Switches

Enabling Switches

Safety Control Relays

Light Curtains

AS-Interface Safety at Work

Operating Instructions

Operating Direction

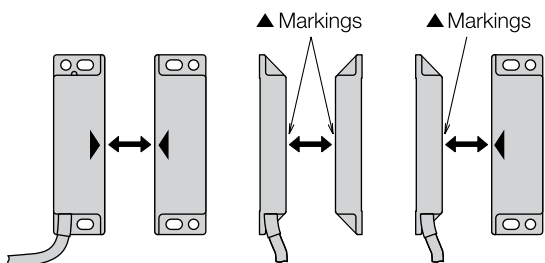

Safety output ON distance (SAO): 3mm.

Precautions for Installation

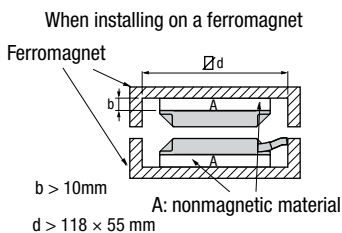

Close mounting

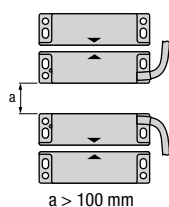

Tightening Torque

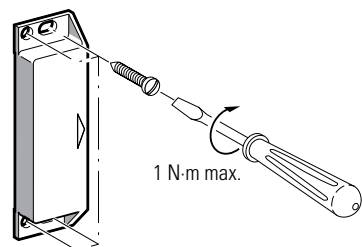

⚠ Use a nonmagnetic screw.

Operation Chart

HS7A-DMP50 □ □
(1NO+2NC)
Brown/Blue
White/Black
Gray/Pink

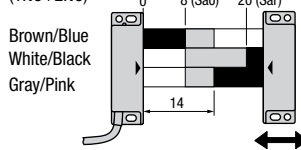

HS7A-DMP70 □ □
(2NO+1NC)
Brown/Blue
White/Black
Gray/Pink

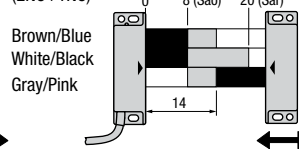

Contact Status

1	Contact closed (1)
0	Contact open (0)
-	Transient area

Sao: Assured operating distance where the safety output is sure to turn on.
Sar: Assured release distance when the safety output is sure to turn off.

Note: When the transfer time between the actuator's Sao-Sar is 500 ms or longer, the time lag is detected as an error.

Operation Area

