

## TWTD Series – Full Size NEMA Pushbuttons



### TWTD Series: Heavy duty switches built to last

Key features include:

- Variety of button sizes up to 2 9/16" (65mm)
- Rugged construction includes chrome plated zinc locking ring die cast zinc mounting threads, screw mounted contact blocks
- LED or incandescent illumination
- Transformer or full voltage
- Transparent contact windows
- Slow make, double break self-cleaning contacts
- Modular construction for maximum flexibility
- Double nickel plated terminal screws
- Available assembled or as sub-components
- NEMA 4x and IP65 watertight/oiltight panel
- Large M3.5 screw terminals with captive sems plate

The rugged series of TWTD switches offers both variety and durability in an attractive design.

With button sizes up to 2 9/16" (65mm), chrome plated zinc locking rings, die cast zinc mounting threads, steel anti-rotation rings, and self cleaning contacts, the TWTDs are here to stay.

The TWTD series also offers either LED or incandescent illumination in full voltage and transformer models.

Transparent contact windows allow the viewing of IDEC's self cleaning slow-make/slow-break contacts.

Regardless of your switching needs, the TWTD series provides the kind of long lasting, industrial strength quality you've come to expect from IDEC.



**Specifications**

Conforming to Standards	EN60947-1, EN60947-5-1, VDE0660-200, UL508, CSA C22-2 No.14
Approvals	<p><b>CSA:</b> pushbuttons and selector switches: A600 pilot lights and illuminated pushbuttons, direct supply pilot lights and illuminated pushbuttons with integral transformer (100/110, 115, 120, 200/220, 230, 240, 380, 400/440, 480V)</p> <p><b>UL:</b> pushbuttons and selector switches: A600 pilot lights and illuminated pushbuttons, direct supply pilot lights and illuminated pushbuttons with integral transformer (100/110, 115, 120, 200/220, 230, 240, 380, 400/440, 480V)</p> <p><b>TÜV:</b> pushbuttons and selector switches: A600=P600 (NO, NC)/Q600 (NO-EM, NC-LB) pilot lights and illuminated pushbuttons, direct supply pilot lights and illuminated pushbuttons with integral transformer (100/110, 115, 120, 200/220, 230, 240, 380, 400/440, 480V)</p>
Operating Temperature	Operation: -25 to +50°C (without freezing) Storage: -40 to +70°C (without freezing)
Vibration Resistance	10 to 55Hz, 98m/sec <sup>2</sup> (10g) conforming to IEC6068-2-6
Shock Resistance	980m/sec <sup>2</sup> (100g) conforming to IEC6068-2-7
Electric Shock Protection	Class 0 conforming to IEC60536
Degree of Protection	IP65 (from front of the panel) (conforming to IEC60529) IP54 (key switches) NEMA 1, 2, 3, 3R, 3S, 4, 4X, 5, 12, 13 (conforming to NEMA ICS6-110)
Mechanical Life	Momentary pushbuttons: 5,000,000 (900 operations per hour) All other switches: 500,000
Pollution Degree (conforming to IEC60947-1)	3 for switches not using a transformer 2 for switches using a transformer

**Mechanical-Electrical Specifications**

Rated Operational Characteristics	AC-15: A600 or Ue = 250V, Ie = 3A (NO, NC, NO-EM, NC-LB) DC-13: P600 or Ue = 125V, Ie = 1.1A (NO, NC) DC-13: Q600 or Ue = 125V, Ie = 0.9A (NO-EM, NC-LB)
Rated Insulation Voltage	600V
Rated Switching Overvoltage	Less than 4kV, conforming to IEC60947-1
Rated Impulse Withstanding Voltage	4kV for contact circuit 2.5kV for lamp circuit
Rated Thermal Current	10 Amp
Minimum Switching Capacity	5 mA at 3V AC/DC
Contact Operation	Slow break NC or NO, self-cleaning
Operating Force	Flush and extended pushbuttons—with 1NO or 1NC contact: 6.2±2N (momentary), 7.0±2N (maintained) Additional contacts—1NO or 1NC: +3.2N (momentary), + 3.3N (maintained)
Terminal Referencing	Conforming to CENELEC EN50005
Recommended Terminal Torque	0.8 N m (7.1 in lb.)
External Short-Circuit Protection	10A 250V fuse conforming to IEC60269-1
Applicable Wire Size	Minimum 1 x 22 AWG, max. 2 x 14 AWG or 1 x 12 AWG
Contact Resistance	Initial contact resistance of 50mΩ or less
Contact Gap	4mm (NO and NC) 2mm (NO-EM and NC-LB)
Lamp Ratings	Incandescent: 1 W LEDs: 6V: 17mA, 12V: 11mA, 24V: 11mA, / 120, 240V: 10mA
Maximum Inrush Current	40 A (40 msec)
Contact Material	Silver

**Contact Ratings**

Contact Ratings by Utilization Category IEC 60947-5-1		AC-15 (A600)						
		DC-13 (P600)						
Contact Ratings by Utilization Category								
Operational Voltage		24V    48V    50V    110V    220V    440V						
Operation Current	AC 50/60 Hz	AC-12 Control of resistive loads & solid state loads	10A	—	10A	10A	6A	2A
		AC-15 Control of electromagnetic loads (> 72VA)	10A	—	7A	5A	3A	1A
	DC	DC-12 Control of resistive loads & solid state loads	8A	5A	—	2.2A	1.1A	—
		DC-13 Control of electromagnets	5A	2A	—	1.1A	0.6A	—

Switches & Pilot Lights

Display Lights

Relays & Sockets

Timers

Terminal Blocks

Circuit Breakers

**Non-Illuminated Pushbuttons (Assembled)**



**Assembled Pushbuttons**

**A B ( ) D 1 10 N - R**

**Function**

- B: Momentary
- O: Maintained
- V: Pushlock Turn Reset
- Y: Push-Pull

**Bezel Shape**

- Blank: Octagonal
- F: Full Shroud
- G: Mushroom Shroud
- P: Neoprene Boot

**Series Designation**

- D: TWTD Series

**Button Color**

- B: Black    G: Green    W: White
- R: Red      S: Blue      Y: Yellow

**Contact Arrangement**

- 10: 1NO      01: 1NC
- 20: 2NO      02: 2NC
- 11: 1NO-1NC    22: 2NO-2NC

**Button Shape**

- 1: Flush
- 2: Extended
- 3: Mushroom ø 40mm
- 4: Jumbo Mushroom ø 65mm



1. Use only when interpreting part numbers. Do not use for developing part numbers.
2. Custom contact configurations available, contact IDEC for details.

Non-Illuminated Pushbuttons (Assembled)

Non-Illuminated Pushbuttons

Style	Contacts	Momentary	Maintained
Flush	1NO	ABD110N-⓪	AOD110N-⓪
	1NC	ABD101N-⓪	AOD101N-⓪
	1NO-1NC	ABD111N-⓪	AOD111N-⓪
	2NO	ABD120N-⓪	AOD120N-⓪
	2NC	ABD102N-⓪	AOD102N-⓪
Extended	1NO	ABD210N-⓪	AOD210N-⓪
	1NC	ABD201N-⓪	AOD201N-⓪
	1NO-1NC	ABD211N-⓪	AOD211N-⓪
	2NO	ABD220N-⓪	AOD220N-⓪
	2NC	ABD202N-⓪	AOD202N-⓪
Extended with Neoprene Boot <sup>†</sup>	1NO	ABPD210N-⓪	AOPD210N-⓪
	1NC	ABPD201N-⓪	AOPD201N-⓪
	1NO-1NC	ABPD211N-⓪	AOPD211N-⓪
	2NO	ABPD220N-⓪	AOPD220N-⓪
	2NC	ABPD202N-⓪	AOPD202N-⓪
Recessed	1NO	ABFD110N-⓪	AOFD110N-⓪
	1NC	ABFD101N-⓪	AOFD101N-⓪
	1NO-1NC	ABFD111N-⓪	AOFD111N-⓪
	2NO	ABFD120N-⓪	AOFD120N-⓪
	2NC	ABFD102N-⓪	AOFD102N-⓪
Extended with Full Shroud	1NO	ABFD210N-⓪	AOFD210N-⓪
	1NC	ABFD201N-⓪	AOFD201N-⓪
	1NO-1NC	ABFD211N-⓪	AOFD211N-⓪
	2NO	ABFD220N-⓪	AOFD220N-⓪
	2NC	ABFD202N-⓪	AOFD202N-⓪
ø 40mm Mushroom Head	1NO	ABD310N-⓪	AOD310N-⓪
	1NC	ABD301N-⓪	AOD301N-⓪
	1NO-1NC	ABD311N-⓪	AOD311N-⓪
	2NO	ABD320N-⓪	AOD320N-⓪
	2NC	ABD302N-⓪	AOD302N-⓪
ø 40mm Mushroom Head with Full Shroud	1NO	ABGD310N-⓪	AOGD310N-⓪
	1NC	ABGD301N-⓪	AOGD301N-⓪
	1NO-1NC	ABGD311N-⓪	AOGD311N-⓪
	2NO	ABGD320N-⓪	AOGD320N-⓪
	2NC	ABGD302N-⓪	AOGD302N-⓪
ø 65mm Jumbo Mushroom Head	1NO	ABD410N-⓪	AOD410N-⓪
	1NC	ABD401N-⓪	AOD401N-⓪
	1NO-1NC	ABD411N-⓪	AOD411N-⓪
	2NO	ABD420N-⓪	AOD420N-⓪
	2NC	ABD402N-⓪	AOD402N-⓪
ø 65mm Jumbo Mushroom Head with Shallow Shroud	1NO	ABGD410N-⓪	AOGD410N-⓪
	1NC	ABGD401N-⓪	AOGD401N-⓪
	1NO-1NC	ABGD411N-⓪	AOGD411N-⓪
	2NO	ABGD420N-⓪	AOGD420N-⓪
	2NC	ABGD402N-⓪	AOGD402N-⓪
ø 65mm Jumbo Mushroom Head With Deep Shroud	1NO	ABFD410N-⓪	AOFD410N-⓪
	1NC	ABFD401N-⓪	AOFD401N-⓪
	1NO-1NC	ABFD411N-⓪	AOFD411N-⓪
	2NO	ABFD420N-⓪	AOFD420N-⓪
	2NC	ABFD402N-⓪	AOFD402N-⓪

① Button Color Codes

Color	Code
Black	B
Green	G
Red	R
Blue	S
Yellow	Y
White	W

- 1. 65mm Jumbo mushroom not available in white.
- 2. Neoprene boot is not available in blue or white.

- 1. In place of ⓪, specify the Button Color Code.
- 2. For sub-assembly part numbers, see next page.
- 3. For accessories, see page 632.
- 4. <sup>†</sup>Neoprene boot available only in Black (B), Green (G), Red (R) and Yellow (Y).

Non-Illuminated Pushbuttons (Sub-Assembled)

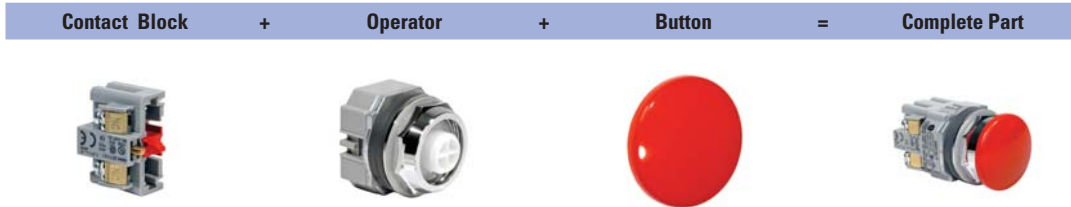

Operators

Style	Part Number	
	Momentary	Maintained
Flush/Extended	ABD-100	AOD-100
Extended with Full Shroud	ABFD-200	AOFD-200
ø 40mm Mushroom/ø 65mm Jumbo Mushroom	ABD-300	AOD-300
ø 40mm Mushroom with Full Shroud	ABGD-300	AOGD-300
ø 65mm Jumbo Mushroom with Shallow Shroud	ABGD-400	AOGD-400
ø 65mm Jumbo Mushroom with Deep Shroud	ABFD-400	AOFD-400

Buttons and Lenses

Style	Part Number
Flush	ABD1BN-Ⓢ
Extended	ABD2BN-Ⓢ
ø 40mm Mushroom	ABD3BN-Ⓢ
ø 65mm Jumbo Mushroom	ABD4BN-Ⓢ



In place of Ⓢ, specify the Button Color Code. (See table previous page)

Contact Blocks

Style	Part Number	
	1NO	1NC
	BST-010	BST-001
	BST-010S (early make)	BST-001S (late break)
Dummy Block	BST-D	



- Dummy blocks (no contacts) are used with an odd number of contact blocks.
- Combining BST-010S and BST-001S result in overlapping contacts.

Switches & Pilot Lights  
Display Lights  
Relays & Sockets  
Timers  
Terminal Blocks  
Circuit Breakers

E-Stops (Assembled)

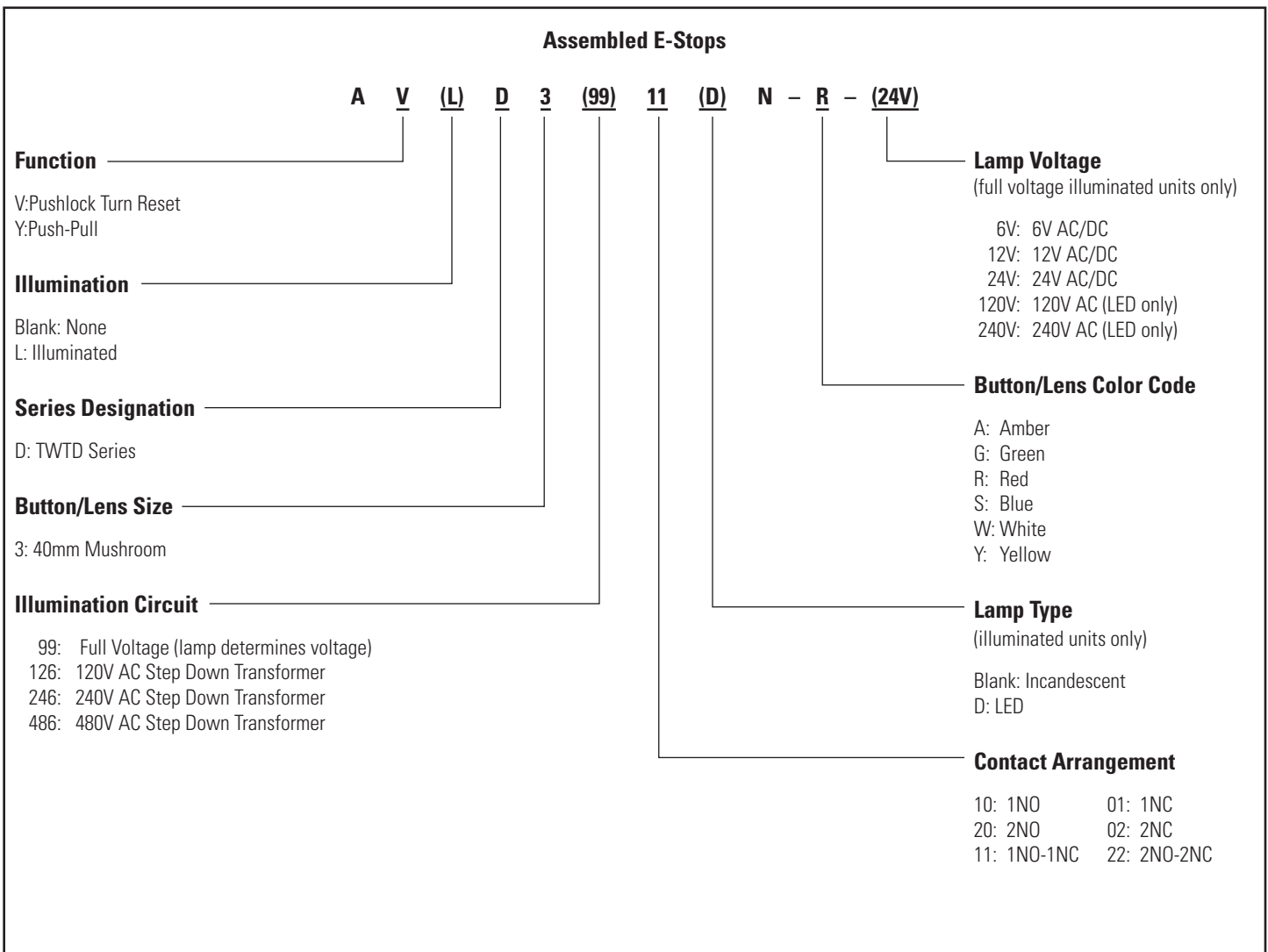



1. Use only when interpreting part numbers. Do not use for developing part numbers.  
2. Custom contact configurations available, contact IDEC for details.



E-Stops (Assembled)

E-Stop Switches

Style	Contacts	Part Number
 ø 40mm Pushlock Turn Reset Non-Illuminated	1NO 1NC 1NO-1NC 2NO 2NC	AVD310N-R* AVD301N-R* AVD311N-R* AVD320N-R* AVD302N-R*
 ø 40mm Illuminated Pushlock Turn Reset Full Voltage	1NO-1NC 2NO 2NC	AVLD39911ⓈN-R-③* AVLD39920ⓈN-R-③* AVLD39902ⓈN-R-③*
 ø 40mm Push-Pull Non-Illuminated	1NO 1NC 1NO-1NC 2NO 2NC	AYD310N-① AYD301N-① AYD311N-① AYD320N-① AYD302N-①
 ø 40mm Push-Pull Full Voltage	1NO-1NC 2NO 2NC	AYLD39911ⓈN-②-③** AYLD39920ⓈN-②-③** AYLD39902ⓈN-②-③**
 ø 40mm Push-Pull Transformer	1NO-1NC 2NO 2NC	AYLD3 ④ 11ⓈN-R* AYLD3 ④ 20ⓈN-R* AYLD3 ④ 02ⓈN-R*
 ø 40mm Momentary Push-Pull (3-position) Full Voltage	1NO-1NC 1NC-1LB†	AYLD229911ⓈN-②-③ -TK962 AYLD229902SⓈN-②-③-TK962
 ø 40mm Momentary Push-Pull (3-position) Transformer	1NO-1NC 1NC-1LB†	AYLD22 ④ 11ⓈN-②-TK962 AYLD22 ④ 02SⓈN-②-TK962

Unibody E-Stops

Style	Contacts	Part Number
 ø 40mm Pushlock Turn Reset (available in Red only)	1NO-1NC 2NC	HN1E-BV4F11-R* HN1E-BV4F02-R*
 Illuminated ø 40mm Pushlock Turn Reset (available in Red only)	1NO-1NC 2NC	HN1E-LV4F11QⓈ-R-③ HN1E-LV4F02QⓈ-R-③

3 Position Push-Pull†

Contact	Push	Center	Pull
NC (BST-001)	0	0	X
NC-LB (BST-001S)	0	X	X
NO (BST-010)	X	0	0
NO-EM (BST-010S)	X	X	0

① Button Color Codes

Color	Code
Black	B
Green	G
Red	R
Blue	S
Yellow	Y

② LED/Lens Color Codes

Color	Code
Amber	A
Green	G
Red	R
Blue	S
White	W

③ Full Voltage Codes

Voltage	Code
6V AC/DC	6V
12V AC/DC	12V
24V AC/DC	24V
120V AC	120V
240V AC	240V (LED only)

④ Transformer Voltage Codes

Voltage	Code
120VAC	126
240VAC	246
480VAC	486



Transformers step down to 6V.

⑤ Lamp Type Codes

Lamp	Code
Incandescent	Blank
LED	D



- In place of ①, specify the button color code.
- In place of ②, specify the lens color code.
- In place of ③, specify the Full Voltage (lamp voltage) Code.
- In place of ④, specify the transformer voltage code.
- In place of ⑤, specify the Lamp Type code.
- With single unit construction, the positive action contacts are integrated in the body of the switch. This provides an extra degree of safety and reliability for critical emergency stop functions.
- HN1E series E-stops comply with EN418, the IEC "E-Stop Addendum to the Low Voltage Directive," this includes "tamper proof" operation whereby a change of contact state is not possible by "teasing" or "floating" the operator.
- 3 position push-pull available in spring return to center only.
- \*Available in red only.
- \*\*Not available in blue.
- †The most common configuration for motor starting applications.
12. For sub-assembly part numbers, see next page.
13. For nameplates and accessories, see page 634 and 632.
14. For dimensions, see page 637.

Switches & Pilot Lights

Display Lights

Relays & Sockets

Timers

Terminal Blocks

Circuit Breakers

E-Stops (Sub-Assembled)

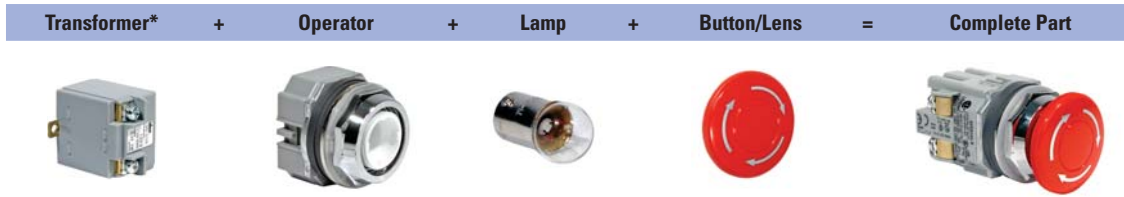

\* Not required for full voltage units (full voltage clips used instead).

Operators

Style	Image	Part Number
ø 40mm Pushlock Turn Reset		AVD-300
Illuminated ø 40mm Pushlock Turn Reset		AVLD3-0600N
ø 40mm Push-Pull		AYD-3100
Illuminated ø 40mm Push-Pull	2 pos	AYLD-0600
	3 pos	AYLD22TK962-0B01

Buttons and Lenses

Style	Image	Part Number
Button for Pushlock Turn Reset E-Stop (ø 40mm, red only)		AVN3B-R
Lens for Illuminated Pushlock Turn Reset E-Stop (ø 40mm, red only)		AVLN3LU-R
Button for Push-Pull E-Stop (ø 40mm)		AYD3BN-①
Lens for Illuminated Push-Pull E-Stop (ø 40mm)	2 pos*	AYLD3L-②
	3 pos	AYLD2L-②

1. In place of ①, specify the Button Color Code. (See table below)  
 2. In place of ②, specify the LED Color Code.  
 3. \*Not available in blue.

Lamps

Style	Voltage	Part Number
	6V AC/DC	LSTD-6②
	12V AC/DC	LSTD-1②
	24V AC/DC	LSTD-2②
	120V AC	LSTD-H2②
	240V AC	LSTD-M4②
	6V AC/DC	IS-6
	12V AC/DC	IS-12
	24V AC/DC	IS-24
	120V AC	L-120L

1. In place of ②, specify the LED color code.  
 2. The LED contains a current-limiting resistor and a protection diode.

① Button Color Codes

Color	Code
Black	B
Green	G
Red	R
Blue	S
Yellow	Y

② LED Color Codes

Color	Code
Amber	A
Green	G
Red	R
Blue	S
White	W

Contact Blocks

Style	Part Number	
	1NO	1NC
	BST-010	BST-001
	BST-010S (early make)	BST-001S (late break)
Dummy Block	BST-D	

1. Dummy blocks (no contacts) are used with an odd number of contact blocks.  
 2. Combining BST-010S and BST-001S result in overlapping contacts.

Full Voltage Clips

Primary Voltage (50/60Hz)	Part Number
	APD-F

Transformers

Description	Primary Voltage (50/60Hz)	Part Number
	120V AC	TWD-0126
	240V AC	TWD-0246
	480V AC	TWD-0486

6V secondary voltage (uses 6V lamp).



**Pilot Lights (Assembled)**



**Assembled Pilot Lights**

**A P D 1 126 D N - R - ( )**

**Function**  
P: Pilot Light

**Series Designation**  
D: TWTD Series

**Lens Shape**  
1: Dome

**Rated Operational Voltage (Primary)**  
Transformer Type    Full Voltage Type  
126: 120V AC        99: Full Voltage  
246: 240V AC  
486: 480V AC



**Lamp Voltage**  
(full voltage illuminated units only)  
6V: 6V AC/DC  
12V: 12V AC/DC  
24V: 24V AC/DC  
120V: 120V AC (LED only)  
240V: 240V AC (LED only)

**Lens Color Code**  
A: Amber  
G: Green  
R: Red  
S: Blue  
W: White  
Y: Yellow

**Lamp Type**  
Blank: Incandescent  
D: LED

Use only when interpreting part numbers. Do not use for developing part numbers.

**LED and Incandescent Pilot Lights**

Style	Operating Voltage	Part Number	
		LED	Incandescent
 Transformer Dome	120V AC 240V AC 480V AC	APD1126DN-② APD1246DN-② APD1486DN-②	APD1126N-② APD1246N-② APD1486N-②
 Full Voltage Dome	—	APD199DN-②-③	APD199N-②-③

**② Lens Color Codes**

Color	Code
Amber	A
Green	G
Red	R
Blue	S
White	W
Yellow	Y

**③ Full Voltage Codes**

Voltage	Code
6V AC/DC	6V
12V AC/DC	12V
24V AC/DC	24V
120V AC	120V
240V AC	240V (LED only)

- 1. In place of ②, specify the Lens/LED Color Code.
- 2. In place of ③, specify the Full Voltage Code (lamp voltage).
- 3. Yellow pilot light comes with white LED.

Pilot Lights (Sub-Assembled)



\* Not required for full voltage units (full voltage clips used instead).

One Each from Left Column plus One Selection from Right Column

Operators

Style	Part Number
	APD-006
	APD-199



Full voltage operator comes with full voltage clips.

Lenses

Style	Part Number
	APN106LN-Ⓢ

1. In place of Ⓢ, specify the Lens Color Code.  
2. LED and incandescent lenses differ in shade only. Some colors have only one shade.

Lamps

Style	Voltage	Part Number
	6V AC/DC	LSTD-6Ⓢ
	12V AC/DC	LSTD-1Ⓢ
	24V AC/DC	LSTD-2Ⓢ
	120V AC	LSTD-H2Ⓢ
	240V AC	LSTD-M4Ⓢ
	6V AC/DC	IS-6
	12V AC/DC	IS-12
	24V AC/DC	IS-24
	120V AC	L-120L

1. In place of Ⓢ, specify the LED color code.  
2. The LED contains a current-limiting resistor and a protection diode.

Full Voltage Clips

Primary Voltage (50/60Hz)	Part Number
	APD-F

Required for all full voltage models. Two pieces each.

Transformers

Description	Primary Voltage (50/60Hz)	Part Number
	120V AC	TWD-0126
	240V AC	TWD-0246
	480V AC	TWD-0486

6V secondary voltage (use 6V lamp).

Ⓢ LED/Lens Color Codes

Color	Code
Amber	A
Green	G
Red	R
Blue	S
White	W
Yellow	Y

Yellow lens only. Yellow LED not available, use white LED.

**Illuminated Pushbuttons (Assembled)**

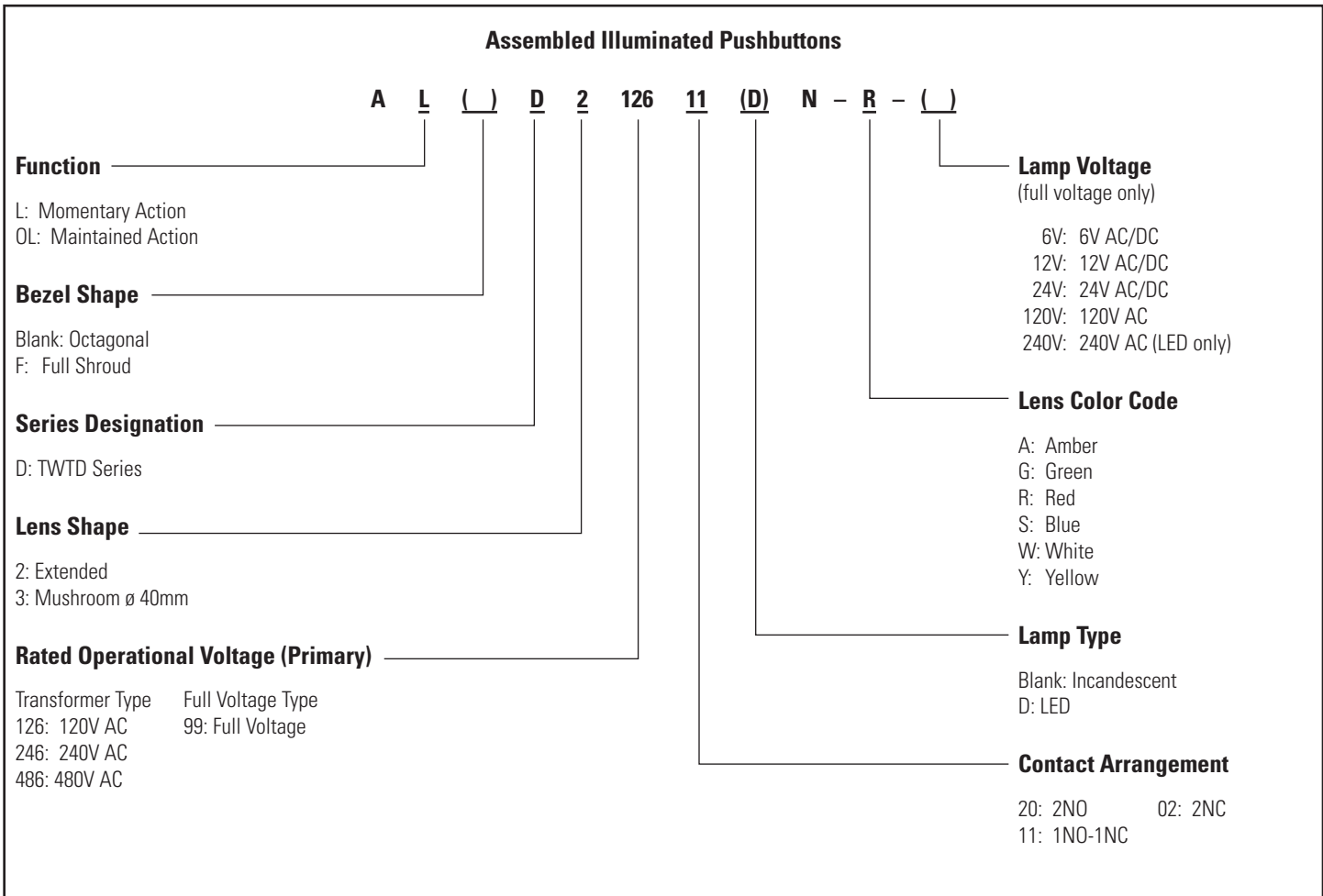

1. Use only when interpreting part numbers. Do not use for developing part numbers.  
2. All transformers and AC Adaptors step down to 6V.

Illuminated Pushbuttons (Assembled)

Illuminated Pushbuttons

Style	Contacts	Part Number		
		Momentary	Maintained	
Extended Lens 	Full Voltage	1NO-1NC 2NO 2NC	ALD29911ⓈN-②-③ ALD29920ⓈN-②-③ ALD29902ⓈN-②-③	AOLD29911ⓈN-②-③ AOLD29920ⓈN-②-③ AOLD29902ⓈN-②-③
	Transformer	1NO-1NC 2NO 2NC	ALD2 ⊕ 11ⓈN-② ALD2 ⊕ 20ⓈN-② ALD2 ⊕ 02ⓈN-②	AOLD2 ⊕ 11ⓈN-② AOLD2 ⊕ 20ⓈN-② AOLD2 ⊕ 02ⓈN-②
Extended Lens with Full Shroud 	Full Voltage	1NO-1NC 2NO 2NC	ALFD29911ⓈN-②-③ ALFD29920ⓈN-②-③ ALFD29902ⓈN-②-③	AOLFD29911ⓈN-②-③ AOLFD29920ⓈN-②-③ AOLFD29902ⓈN-②-③
	Transformer	1NO-1NC 2NO 2NC	ALFD2 ⊕ 11ⓈN-② ALFD2 ⊕ 20ⓈN-② ALFD2 ⊕ 02ⓈN-②	AOLFD2 ⊕ 11ⓈN-② AOLFD2 ⊕ 20ⓈN-② AOLFD2 ⊕ 02ⓈN-②
ø 40mm Mushroom Lens 	Full Voltage	1NO-1NC 2NO 2NC	ALD39911ⓈN-②-③ ALD39920ⓈN-②-③ ALD39902ⓈN-②-③	AOLD39911ⓈN-②-③ AOLD39920ⓈN-②-③ AOLD39902ⓈN-②-③
	Transformer	1NO-1NC 2NO 2NC	ALD3 ⊕ 11ⓈN-② ALD3 ⊕ 20ⓈN-② ALD3 ⊕ 02ⓈN-②	AOLD3 ⊕ 11ⓈN-② AOLD3 ⊕ 20ⓈN-② AOLD3 ⊕ 02ⓈN-②

② Lens Color Codes

Color	Code
Amber	A
Green	G
Red	R
Blue	S
White	W
Yellow	Y

③ Full Voltage Codes

Voltage	Code
6V AC/DC	6V
12V AC/DC	12V
24V AC/DC	24V
120V AC	120V
240V AC	240V (LED only)

④ Transformer Voltage Codes

Voltage	Code
120VAC	126
240VAC	246
480VAC	486

 6V secondary voltage (uses 6V lamp).

⑤ Lamp Type Codes

Lamp	Code
Incandescent	Blank
LED	D

- 1. In place of ②, specify the Lens Color Code.
- 2. In place of ③, specify the Full Voltage Code (lamp voltage).
- 3. In place of ④, specify the Transformer Voltage Code.
- 4. In place of ⑤, specify the Lamp Type Code.
- 5. Light is independent of switch position.
- 6. Yellow pushbutton comes with white LED only.

### Illuminated Pushbuttons (Sub-Assembled)

Transformer\* + Contact Block + Operator + Lamp + Lens = Complete Part



\*Not required for full voltage types (full voltage types use APD-F full voltage clips).

#### Operators

Style	Image	Part Number	
		Momentary	Maintained
Extended		ALD-0600	AOLD-0600
Extended with Full Shroud		ALFD-0600	AOLFD-0600
40mm Mushroom		ALD-0600	AOLD-0600

#### Lamps

Style	Voltage	Part Number
LED	6V AC/DC	LSTD-6Ⓢ
	12V AC/DC	LSTD-1Ⓢ
	24V AC/DC	LSTD-2Ⓢ
	120V AC	LSTD-H2Ⓢ
	240V AC	LSTD-M4Ⓢ
Incandescent	6V AC/DC	IS-6
	12V AC/DC	IS-12
	24V AC/DC	IS-24
	120V AC	L-120L

#### LED/Lens Color Codes

Color	Code
Amber	A
Green	G
Red	R
Blue	S
White	W
Yellow	Y

Yellow lens only. Yellow LED not available, use white LED.

1. In place of Ⓢ, specify the LED color code.
2. The LED contains a current-limiting resistor and a protection diode.

#### Contact Blocks

Style	Part Number	
	1NO	1NC
All Control Units	BST-010	BST-001
	BST-010S (early make)	BST-001S (late break)
Dummy Block	BST-D	

1. Dummy blocks (no contacts) are used with an odd number of contact blocks.
2. Combining BST-010S and BST-001S result in overlapping contacts (remain on, or closed, when switch is moved between two positions).

#### Transformers

Description	Primary Voltage (50/60Hz)	Part Number
Transformers	120V AC	TWD-0126
	240V AC	TWD-0246
	480V AC	TWD-0486

6V secondary voltage (use 6V lamp).

#### Lenses

Style	Image	Part Number
Extended		ALN06LU-Ⓢ
ø 40mm Mushroom		ALN3LU-Ⓢ

In place of Ⓢ, specify the Lens Color Code.

#### Full Voltage Clips

Style	Image	Part Number
Full Voltage Clips (2 required for each unit)		APD-F

Required for all full voltage models.

Non-Illuminated Selector Switches (Assembled)



**Assembled Selector Switches**

**A S D 2 ( ) ( ) 11 N - ( )**

**Function** \_\_\_\_\_

S: Selector Switch

**Series Designation** \_\_\_\_\_

D: TWTD Series

**Number of Positions** \_\_\_\_\_

2: 2-Position  
3: 3-Position

**Spring Return Action** \_\_\_\_\_

Blank: Maintained  
1: Spring return from Right  
2: Spring return from Left  
3: 2-Way spring return from Left and Right

**Circuit Number** \_\_\_\_\_

(See Circuit # column of Selector Switch Contact Arrangement Chart on beginning on page 629.)

**Contact Arrangement Code**

10: 1NO    01: 1NC  
20: 2NO    02: 2NC  
40: 4NO    04: 4NC  
11: 1NO-1NC    22: 2NO-2NC

**Operator Style Code**

Blank: Knob Operator  
L: Lever Operator  
K: Key Operator

1. Use only when interpreting part numbers. Do not use for developing part numbers.  
2. Custom key removal codes available. Please contact IDEC for details.



**Non-Illuminated Selector Switches (Assembled)**

**Non-Illuminated 2-Position Selector Switches**

Style				Part Number			
Contact	Mounting	Operator Position			Maintained	Spring Return from Right	Spring Return from Left
		L	R				
<b>1NO</b>	1	0	X	<b>Knob</b>	ASD210N	ASD2110N	ASD2210N
	2	0	0		<b>Lever Key</b>	ASD2L10N ASD2K10N	ASD21L10N ASD21K10N
<b>1NC</b>	1	X	0	<b>Knob</b>	ASD201N-116	ASD2101N-116	ASD2201N-116
	2	0	0		<b>Lever Key</b>	ASD2L01N-116 ASD2K01N-116	ASD21L01N-116 ASD21K01N-116
<b>1NO</b> <b>1NC</b>	1	X	0	<b>Knob</b>	ASD211N	ASD2111N	ASD2211N
	2	0	X		<b>Lever Key</b>	ASD2L11N ASD2K11N	ASD21L11N ASD21K11N
<b>2NO</b>	1	0	X	<b>Knob</b>	ASD220N	ASD2120N	ASD2220N
	2	0	X		<b>Lever Key</b>	ASD2L20N ASD2K20N	ASD21L20N ASD21K20N
<b>2NC</b>	1	X	0	<b>Knob</b>	ASD202N-104	ASD2102N-104	ASD2202N-104
	2	X	0		<b>Lever Key</b>	ASD2L02N-104 ASD2K02N-104	ASD21L02N-104 ASD21K02N-104
<b>2NO</b> <b>2NC</b>	1	0	X	<b>Knob</b>	ASD222N	ASD2122N	ASD2222N
	2	X	0		<b>Lever Key</b>	ASD2L22N ASD2K22N	ASD21L22N ASD21K22N
<b>2NO</b> <b>2NC</b>	1	0	X	<b>Knob</b>	ASD222N-111	ASD2122N-111	ASD2222N-111
	2	0	X		<b>Lever Key</b>	ASD2L22N-111 ASD2K22N-111	ASD21L22N-111 ASD21K22N-111



- The truth table indicates the operating position of contact block when the operator is switched to that position.  
X = On (closed contacts) 0 = Off (open contacts)  
X-X = Overlapping Contacts: Remain on (closed contacts) when switch is moved between these two positions.
- All knob and lever selector switches come in black. Other colors are available by ordering the knob or lever separately.
- Custom contact arrangements available, see page 629 or call IDEC for details.

**Non-Illuminated 3-Position Selector Switches**

Style					Part Number				
Contact	Mounting	Operator Position				Maintained	Spring Return from Right	Spring Return from Left	Spring Return Two-Way
		L	C	R					
<b>2NO</b>	1	X	0	0	<b>Knob</b>	ASD320N	ASD3120N	ASD3220N	ASD3320N
	2	0	0	X		<b>Lever Key</b>	ASD3L20N ASD3K20N	ASD31L20N ASD31K20N	ASD32L20N ASD32K20N
<b>2NC</b>	1	0	X	X	<b>Knob</b>	ASD302N	ASD3102N	ASD3202N	ASD3302N
	2	X	X	0		<b>Lever Key</b>	ASD3L02N ASD3K02N	ASD31L02N ASD31K02N	ASD32L02N ASD32K02N
<b>2NO</b> <b>2NC</b>	1	X	0	0	<b>Knob</b>	ASD322N	ASD3122N	ASD3222N	ASD3322N
	2	0	0	X		<b>Lever Key</b>	ASD3L22N ASD3K22N	ASD31L22N ASD31K22N	ASD32L22N ASD32K22N
<b>2NO</b> <b>2NC</b>	1	X	0	X	<b>Knob</b>	ASD322N-309	ASD3122N-309	ASD3222N-309	ASD3322N-309
	2	X	X	0		<b>Lever Key</b>	ASD3L22N-309 ASD3K22N-309	ASD31L22N-309 ASD31K22N-309	ASD32L22N-309 ASD32K22N-309
<b>2NO</b> <b>2NC</b>	1	0	X	0	<b>Knob</b>	ASD322N-310	ASD3122N-310	ASD3222N-310	ASD3322N-310
	2	0	0	X		<b>Lever Key</b>	ASD3L22N-310 ASD3K22N-310	ASD31L22N-310 ASD31K22N-310	ASD32L22N-310 ASD32K22N-310
<b>4NO</b>	1	X	0	0	<b>Knob</b>	ASD340N	ASD3140N	ASD3240N	ASD3340N
	2	0	0	X		<b>Lever Key</b>	ASD3L40N ASD3K40N	ASD31L40N ASD31K40N	ASD32L40N ASD32K40N
<b>4NC</b>	1	0	X	X	<b>Knob</b>	ASD304N	ASD3104N	ASD3204N	ASD3304N
	2	X	X	0		<b>Lever Key</b>	ASD3L04N ASD3K04N	ASD31L04N ASD31K04N	ASD32L04N ASD32K04N

Switches & Pilot Lights

Display Lights

Relays & Sockets

Timers

Terminal Blocks

Circuit Breakers



Non-Illuminated Selector Switches (Sub-Assembled)

Contact Blocks + Operator + Knob or Lever\* + Color Insert\* = Complete Part†



- 1. \*Not needed with key type switches.
- 2. †Knob type shown.

Operators

Appearance	Position	Description	Part Number	
 Knob/Lever	2	Maintained	ASD200	
		Spring return from right	ASD2100	
		Spring return from left	ASD2200	
	3	Maintained, Cam 1 Maintained, Cam 2		ASD300-1 ASD300-2
			Spring return from right, Cam 1 Spring return from right, Cam 2	ASD3100-1 ASD3100-2
		Spring return from left, Cam 1 Spring return from left, Cam 2		ASD3200-1 ASD3200-2
Spring return from left/right, Cam 1 Spring return from left/right, Cam 2			ASD3300-1 ASD3300-2	
 Key		2	Maintained	ASD2K00-RA
			Spring return from right	ASD21K00-RL
	Spring return from left		ASD22K00	
	3	Maintained, Cam 1 Maintained, Cam 2		ASD3K00-1 ASD3K00-2
			Spring return from right, Cam 1 Spring return from right, Cam 2	ASD31K00-1-RLC ASD31K00-2-RLC
		Spring return from left, Cam 1 Spring return from left, Cam 2	ASD32K00-1-RRC ASD32K00-2-RRC	
Spring return from left/right, Cam 1 Spring return from left/right, Cam 2	ASD33K00-1-RC ASD33K00-2-RC			

- 1. Order knobs, levers, color inserts separately (see below).
- 2. For key switches, keys are removable in all maintained positions. Other options available, contact IDEC for details.
- 3. See page 631 "Operator Truth Tables" for details of difference between cams.

① Color Codes

Knob/Lever Color	Code
Black	B
Blue	S
Green	G
Red	R
Yellow	Y
White	W

- 1. Knob/Lever not available in white.
- 2. Color inserts not available in Black.
- 3. Lever not available in yellow.

Handles and Inserts

	Style	Part Number
Knob		ASDHHY-⊙
		ASDHHL-⊙*
Color Insert		TW-HC1-⊙

- 1. In place of ⊙, specify the Color Code.  
\*Not available in yellow.

Contact Blocks

Style	Part Number	
	1NO	1NC
	BST-010	BST-001
	BST-010S (early make)	BST-001S (late break)
Dummy Block	BST-D	

- 1. Dummy blocks (no contacts) are used with an odd number of contact blocks.
- 2. Combining BST-010S and BST-001S results in overlapping contacts (remain on, or closed, when switch is moved between two positions).

**Illuminated Selector Switches (Assembled)**



Switches & Pilot Lights

Display Lights

Relays & Sockets

Timers

Terminal Blocks

Circuit Breakers

**Assembled Illuminated Selector Switches**

**A SL D 2 (2) 99 11 D N - 111 - R - 24**

<p><b>Function</b></p> <p>SL: Illuminated Selector Switch</p> <p><b>Series Designation</b></p> <p>D: TWTD series</p> <p><b>Number of Positions</b></p> <p>2: 2-Position 3: 3-Position</p> <p><b>Spring Return Action</b></p> <p>Blank: Maintained 1: Spring return from Right 2: Spring return from Left 3: Two-Way spring return from Left and Right</p> <p><b>Rated Operational Voltage (Primary)</b></p> <table border="0"> <tr> <td>Transformer Type</td> <td>Full Voltage Type</td> </tr> <tr> <td>126: 120V AC</td> <td>99: Full Voltage</td> </tr> <tr> <td>246: 240V AC</td> <td></td> </tr> <tr> <td>486: 480V AC</td> <td></td> </tr> </table> <p><b>Contact Arrangement Code</b></p> <table border="0"> <tr> <td>20: 2NO</td> <td>02: 2NC</td> </tr> <tr> <td>40: 4NO</td> <td>04: 4NC</td> </tr> <tr> <td>11: 1NO-1NC</td> <td>22: 2NO-2NC</td> </tr> </table>	Transformer Type	Full Voltage Type	126: 120V AC	99: Full Voltage	246: 240V AC		486: 480V AC		20: 2NO	02: 2NC	40: 4NO	04: 4NC	11: 1NO-1NC	22: 2NO-2NC	<p><b>Lamp Voltage</b> (Full Voltage Units Only)</p> <p>6V: 6V AC/DC 12V: 12V AC/DC 24V: 24V AC/DC 120V: 120V AC 240V: 240V AC (LED only)</p> <p><b>Lens Color Code</b></p> <p>A: Amber G: Green R: Red S: Blue W: White Y: Yellow</p> <p><b>Circuit Code Number</b></p> <p>See Circuit # column of Selector Switch Contact Arrangement Charts on page 629.</p> <p><b>Lamp Type</b></p> <p>Blank: Incandescent Lamp D: LED Lamp</p>
Transformer Type	Full Voltage Type														
126: 120V AC	99: Full Voltage														
246: 240V AC															
486: 480V AC															
20: 2NO	02: 2NC														
40: 4NO	04: 4NC														
11: 1NO-1NC	22: 2NO-2NC														



Use only when interpreting part numbers. Do not use for developing part numbers.

Illuminated Selector Switches(Assembled)

Illuminated 2-Position Selector Switches

Style					Part Number		
Contact	Mounting	Operator Position		Lamp Circuit Type	Maintained	Spring Return from Right	Spring Return from Left
		L	R				
1NO 1NC	1	0	X	Transformer	ASLD2 ④11⑤N-②	ASLD21 ④11⑤N-②	ASLD22 ④11⑤N-②
	2	X	0	Full Voltage	ASLD29911⑤N-②-③	ASLD219911⑤N-②-③	ASLD229911⑤N-②-③
2NO	1	0	X	Transformer	ASLD2 ④20⑤N-②	ASLD21 ④20⑤N-②	ASLD22 ④20⑤N-②
	2	0	X	Full Voltage	ASLD29920⑤N-②-③	ASLD219920⑤N-②-③	ASLD229920⑤N-②-③
2NC	1	X	0	Transformer	ASLD2 ④02⑤N-104-②	ASLD21 ④02⑤N-104-②	ASLD22 ④02⑤N-104-②
	2	X	0	Full Voltage	ASLD29902⑤N-104-②-③	ASLD219902⑤N-104-②-③	ASLD229902⑤N-104-②-③
2NO 2NC	1	0	X	Transformer Full Voltage	ASLD2 ④22⑤N-② ASLD29922⑤N-②-③	ASLD21 ④22⑤N-② ASLD219922⑤N-②-③	ASLD22 ④22⑤N-② ASLD229922⑤N-②-③
	2	X	0				
2NO 2NC	3	0	X	Transformer Full Voltage	ASLD2 ④22⑤N-111-② ASLD29922⑤N-111-②-③	ASLD21 ④22⑤N-111-② ASLD219922⑤N-111-②-③	ASLD22 ④22⑤N-111-② ASLD229922⑤N-111-②-③
	4	X	0				

② LED/Lens Color Codes

Color	Code
Amber	A
Green	G
Red	R
Blue	S
White	W
Yellow	Y

③ Full Voltage Codes

Voltage	Code
6V AC/DC	6V
12V AC/DC	12V
24V AC/DC	24V
120V AC	120V
240V AC	240V (LED only)

Illuminated 3-Position Selector Switches, Maintained and Spring Return

Style					Part Number				
Contact	Mounting	Operator Position			Lamp Circuit Type	Maintained	Spring Return From Right	Spring Return from Left	Spring Return Two-Way
		L	C	R					
2NO	1	X	0	0	Transformer	ASLD3 ④ 20⑤N-②	ASLD31 ④ 20⑤N-②	ASLD32 ④ 20⑤N-②	ASLD33 ④ 20⑤N-②
	2	0	0	X	Full Voltage	ASLD39920⑤N-②-③	ASLD319920⑤N-②-③	ASLD329920⑤N-②-③	ASLD339920⑤N-②-③
2NC	1	0	X	X	Transformer	ASLD3 ④ 02⑤N-②	ASLD31 ④ 02⑤N-②	ASLD32 ④ 02⑤N-②	ASLD33 ④ 02⑤N-②
	2	X	X	0	Full Voltage	ASLD39902⑤N-②-③	ASLD319902⑤N-②-③	ASLD329902⑤N-②-③	ASLD339902⑤N-②-③
2NO 2NC	1	X	0	0	Transformer Full Voltage	ASLD3 ④ 22⑤N-② ASLD39922⑤N-②-③	ASLD31 ④ 22⑤N-② ASLD319922⑤N-②-③	ASLD32 ④ 22⑤N-② ASLD329922⑤N-②-③	ASLD33 ④ 22⑤N-② ASLD339922⑤N-②-③
	2	0	0	X					
2NO 2NC	3	0	X	X	Transformer Full Voltage	ASLD3 ④ 22⑤N-309-② ASLD39922⑤N-309-②-③	ASLD31 ④ 22⑤N-309-② ASLD319922⑤N-309-②-③	ASLD32 ④ 22⑤N-309-② ASLD329922⑤N-309-②-③	ASLD33 ④ 22⑤N-309-② ASLD339922⑤N-309-②-③
	4	X	X	0					
2NO 2NC	1	X	0	X	Transformer Full Voltage	ASLD3 ④ 22⑤N-310-② ASLD39922⑤N-310-②-③	ASLD31 ④ 22⑤N-310-② ASLD319922⑤N-310-②-③	ASLD32 ④ 22⑤N-310-② ASLD329922⑤N-310-②-③	ASLD33 ④ 22⑤N-310-② ASLD339922⑤N-310-②-③
	2	X	X	0					
2NO 2NC	3	0	X	0	Transformer Full Voltage	ASLD3 ④ 22⑤N-310-② ASLD39922⑤N-310-②-③	ASLD31 ④ 22⑤N-310-② ASLD319922⑤N-310-②-③	ASLD32 ④ 22⑤N-310-② ASLD329922⑤N-310-②-③	ASLD33 ④ 22⑤N-310-② ASLD339922⑤N-310-②-③
	4	0	0	X					
4NO	1	X	0	0	Transformer Full Voltage	ASLD3 ④ 40⑤N-② ASLD39940⑤N-②-③	ASLD31 ④ 40⑤N-② ASLD319940⑤N-②-③	ASLD32 ④ 40⑤N-② ASLD329940⑤N-②-③	ASLD33 ④ 40⑤N-② ASLD339940⑤N-②-③
	2	0	0	X					
4NC	3	X	0	0	Transformer Full Voltage	ASLD3 ④ 04⑤N-② ASLD39904⑤N-②-③	ASLD31 ④ 04⑤N-② ASLD319904⑤N-②-③	ASLD32 ④ 04⑤N-② ASLD329904⑤N-②-③	ASLD33 ④ 04⑤N-② ASLD339904⑤N-②-③
	4	0	X	X					



- In place of ②, specify the Lens/LED Color Code, in place of ③, specify the Full Voltage (lamp voltage) Code, in place of ④, specify the Transformer Voltage Code and in place of ⑤ specify the Lamp Type Code.
- The truth table indicates the operating position of contact block when the operator is switched to that position.  
 X = On (Closed Contacts) 0 = Off (Open Contacts)  
 X—X = Overlapping Contacts: Remain on (closed contacts) when switch is moved between these positions
- Yellow selector switch comes with white LED.

④ Transformer Voltage Codes

Voltage	Code
120VAC	126
240VAC	246
480VAC	486

⑤ Lamp Type Codes

Lamp	Code
Incandescent	Blank
LED	D



Transformers step down to 6V (use 6V lamp).

Light is independent of switch position.

Illuminated Selector Switches (Sub-Assembled)



\*Not required for full voltage units (use APD-F full voltage clips instead).

Operators

Style	Position	Description	Part Number
Operator	2	Maintained	ASLD200
	3	Maintained, Cam 1	ASLD300-1
		Maintained, Cam 2	ASLD300-2
	2	Spring return from right	ASLD2100
		Spring return from left	ASLD2200
	3	Spring return from right, Cam 1	ASLD3100-1
		Spring return from right, Cam 2	ASLD3100-2
		Spring return from left, Cam 1	ASLD3200-1
Spring return from left, Cam 2		ASLD3200-2	
	Spring return from left/right, Cam 1	ASLD3300-1	
	Spring return from left/right, Cam 2	ASLD3300-2	

Contact Blocks

Style	Part Number	
	1NO	1NC
	BST-010	BST-001
	BST-010S (early make)	BST-001S (late break)
Dummy Block	BST-D	



- Dummy blocks (no contacts) are used with an odd number of contact blocks.
- Combining BST-010S and BST-001S results in overlapping contacts (remain on, or closed, when switch is moved between two positions).

Lenses

Description	Part Number
	ASLNHU-①

Full Voltage Clips

Style	Part Number
	APD-F



Required for all full voltage models.

Transformers

Description	Primary Voltage (50/60Hz)	Part Number
	120V AC	TWD-0126
	240V AC	TWD-0246
	480V AC	TWD-0486



6V secondary voltage.

② LED/Lens Color Codes

Color	Code	Color	Code
Amber	A	Blue	S
Green	G	White	W
Red	R	Yellow	Y



Yellow lens only. Yellow LED not available, use white LED.

Switches & Pilot Lights

Display Lights

Relays & Sockets

Timers

Terminal Blocks

Circuit Breakers

- In place of ②, specify the LED color code.
- The LED contains a current-limiting resistor and a protection diode.

### Contact Arrangement Charts

#### How to Read Contact Arrangement Charts

To determine contact block mounting position, first make sure the selector switch is oriented as shown on the right

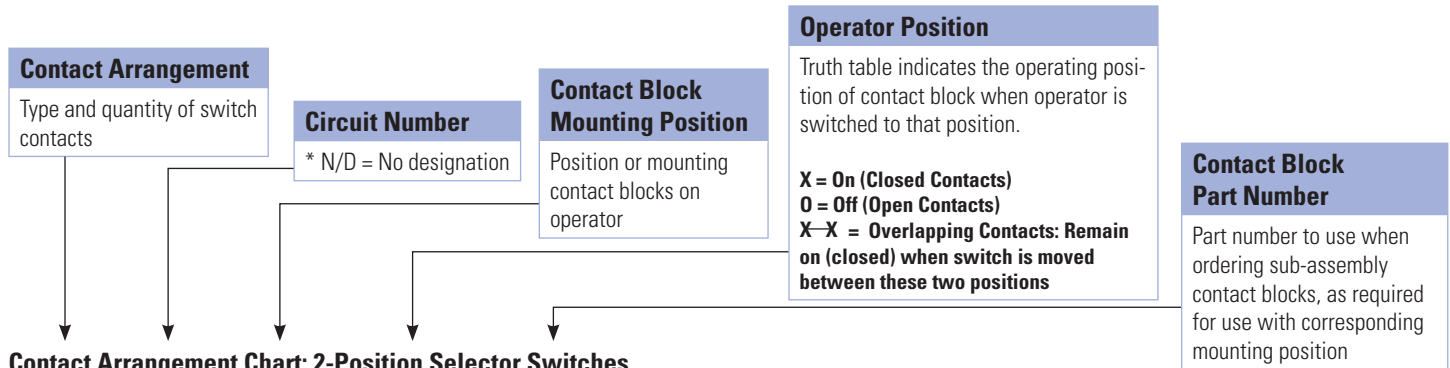

#### Contact Arrangement Chart: 2-Position Selector Switches

Style		Mounting Position	Operator Position		Contact Block Part Number	Description	Operator Part Number		
Contact	Circuit Number		L	R			Maintained	Spring Return from Right	Spring Return from Left
1NO	N/D	1	O	X	BST-010	Knob/Lever Key	ASD200 ASD2K00 ASLD200	ASD2100 ASD21K00 ASLD2100	ASD2200 ASD22K00 ASLD2200
		2	O	O	BST-D	Illuminated Knob			
1NC	116	1	X	O	BST-001	Knob/Lever Key	ASD200 ASD2K00 ASLD200	ASD2100 ASD21K00 ASLD2100	ASD2200 ASD22K00 ASLD2200
		2	O	O	BST-D	Illuminated Knob			
1NO 1NC	N/D	1	O	X	BST-010	Knob/Lever Key	ASD200 ASD2K00 ASLD200	ASD2100 ASD21K00 ASLD2100	ASD2200 ASD22K00 ASLD2200
		2	X	O	BST-001	Illuminated Knob			
	103	1	X	O	BST-001	Knob/Lever Key	ASD200 ASD2K00 ASLD200	ASD2100 ASD21K00 ASLD2100	ASD2200 ASD22K00 ASLD2200
		2	O	X	BST-010	Illuminated Knob			
1NO-EM 1NC-LB	600	1	O	X	BST-010S	Knob/Lever Key	ASD200 ASD2K00 ASLD200	ASD2100 ASD21K00 ASLD2100	ASD2200 ASD22K00 ASLD2200
		2	X	O	BST-001S	Illuminated Knob			
	601	1	X	O	BST-001S	Knob/Lever Key	ASD200 ASD2K00 ASLD200	ASD2100 ASD21K00 ASLD2100	ASD2200 ASD22K00 ASLD2200
		2	O	X	BST-010S	Illuminated Knob			
2NO	N/D	1	O	X	BST-010	Knob/Lever Key	ASD200 ASD2K00 ASLD200	ASD2100 ASD21K00 ASLD2100	ASD2200 ASD22K00 ASLD2200
		2	O	X	BST-010	Illuminated Knob			
2NC	104	1	X	O	BST-001	Knob/Lever Key	ASD200 ASD2K00 ASLD200	ASD2100 ASD21K00 ASLD2100	ASD2200 ASD22K00 ASLD2200
		2	X	O	BST-001	Illuminated Knob			
2NO 2NC	N/D	1	O	X	BST-010	Knob/Lever Key Illuminated Knob	ASD200 ASD2K00 ASLD200	ASD2100 ASD21K00 ASLD2100	ASD2200 ASD22K00 ASLD2200
		2	X	O	BST-001				
		3	O	X	BST-010				
		4	X	O	BST-001				
	110	1	X	O	BST-001	Knob/Lever Key Illuminated Knob	ASD200 ASD2K00 ASLD200	ASD2100 ASD21K00 ASLD2100	ASD2200 ASD22K00 ASLD2200
		2	O	X	BST-010				
		3	X	O	BST-001				
		4	O	X	BST-010				
	111	1	O	X	BST-010	Knob/Lever Key Illuminated Knob	ASD200 ASD2K00 ASLD200	ASD2100 ASD21K00 ASLD2100	ASD2200 ASD22K00 ASLD2200
		2	O	X	BST-010				
		3	X	O	BST-001				
		4	X	O	BST-001				
4NO	N/D	1	O	X	BST-010	Knob/Lever Key Illuminated Knob	ASD200 ASD2K00 ASLD200	ASD2100 ASD21K00 ASLD2100	ASD2200 ASD22K00 ASLD2200
		2	O	X	BST-010				
		3	O	X	BST-010				
		4	O	X	BST-010				

Switches & Pilot Lights

Display Lights

Relays & Sockets

Timers

Terminal Blocks

Circuit Breakers



Contact Arrangement Chart: 3-Position Selector Switches

Contact	Circuit Number	Mounting Position	Operator Position			Contact Block Part Number	Description	Operator Part Number				
			L	C	R			Maintained	Spring Return from Right	Spring Return from Left	Two-Way	
1NO 1NC	202	1	X	0	0	BST-010	Knob/Lever Key	ASD300-1 ASD3K00-1 ASLD300-1	ASD3100-1 ASD31K00-1 ASLD3100-1	ASD3200-1 ASD32K00-1 ASLD3200-1	ASD3300-1 ASD33K00-1 ASLD3300-1	
		2	X	X	0	BST-001	Illuminated Knob					
	203	1	0	X	X	BST-001	Knob/Lever Key	ASD300-1 ASD3K00-1 ASLD300-1	ASD3100-1 ASD31K00-1 ASLD3100-1	ASD3200-1 ASD32K00-1 ASLD3200-1	ASD3300-1 ASD33K00-1 ASLD3300-1	
		2	0	0	X	BST-010	Illuminated Knob					
	302	1	X	0	X	BST-010	Knob/Lever Key	ASD300-2 ASD3K00-2 ASLD300-2	ASD3100-2 ASD31K00-2 ASLD3100-2	ASD3200-2 ASD32K00-2 ASLD3200-2	ASD3300-2 ASD33K00-2 ASLD3300-2	
		2	X	X	0	BST-001	Illuminated Knob					
	303	1	0	X	0	BST-001	Knob/Lever Key	ASD300-2 ASD3K00-2 ASLD300-2	ASD3100-2 ASD31K00-2 ASLD3100-2	ASD3200-2 ASD32K00-2 ASLD3200-2	ASD3300-2 ASD33K00-2 ASLD3300-2	
		2	0	0	X	BST-010	Illuminated Knob					
	2NO	N/D	1	X	0	0	BST-010	Knob/Lever Key	ASD300-1 ASD3K00-1 ASLD300-1	ASD3100-1 ASD31K00-1 ASLD3100-1	ASD3200-1 ASD32K00-1 ASLD3200-1	ASD3300-1 ASD33K00-1 ASLD3300-1
			2	0	0	X	BST-010	Illuminated Knob				
		301	1	X	0	X	BST-010	Knob/Lever Key	ASD300-2 ASD3K00-2 ASLD300-2	ASD3100-2 ASD31K00-2 ASLD3100-2	ASD3200-2 ASD32K00-2 ASLD3200-2	ASD3300-2 ASD33K00-2 ASLD3300-2
			2	0	0	X	BST-010	Illuminated Knob				
2NC	304	1	0	X	0	BST-001	Knob/Lever Key	ASD300-2 ASD3K00-2 ASLD300-2	ASD3100-2 ASD31K00-2 ASLD3100-2	ASD3200-2 ASD32K00-2 ASLD3200-2	ASD3300-2 ASD33K00-2 ASLD3300-2	
		2	X	X	0	BST-001	Illuminated Knob					
	N/D	1	0	X	X	BST-001	Knob/Lever Key	ASD300-1 ASD3K00-1 ASLD300-1	ASD3100-1 ASD31K00-1 ASLD3100-1	ASD3200-1 ASD32K00-1 ASLD3200-1	ASD3300-1 ASD33K00-1 ASLD3300-1	
		2	X	X	0	BST-001	Illuminated Knob					
2NO 2NC	N/D	1	X	0	0	BST-010	Knob/Lever Key Illuminated Knob	ASD300-1 ASD3K00-1 ASLD300-1	ASD3100-1 ASD31K00-1 ASLD3100-1	ASD3200-1 ASD32K00-1 ASLD3200-1	ASD3300-1 ASD33K00-1 ASLD3300-1	
		2	0	0	X	BST-010						
		3	0	X	X	BST-001						
		4	X	X	0	BST-001						
	210	1	0	X	X	BST-001	Knob/Lever Key Illuminated Knob	ASD300-1 ASD3K00-1 ASLD300-1	ASD3100-1 ASD31K00-1 ASLD3100-1	ASD3200-1 ASD32K00-1 ASLD3200-1	ASD3300-1 ASD33K00-1 ASLD3300-1	
		2	0	0	X	BST-010						
		3	0	X	X	BST-001						
		4	0	0	X	BST-010						
	308	1	X	0	X	BST-010	Knob/Lever Key Illuminated Knob	ASD300-2 ASD3K00-2 ASLD300-2	ASD3100-2 ASD31K00-2 ASLD3100-2	ASD3200-2 ASD32K00-2 ASLD3200-2	ASD3300-2 ASD33K00-2 ASLD3300-2	
		2	X	X	0	BST-001						
		3	X	0	X	BST-010						
		4	X	X	0	BST-001						
	309	1	X	0	X	BST-010	Knob/Lever Key Illuminated Knob	ASD300-2 ASD3K00-2 ASLD300-2	ASD3100-2 ASD31K00-2 ASLD3100-2	ASD3200-2 ASD32K00-2 ASLD3200-2	ASD3300-2 ASD33K00-2 ASLD3300-2	
		2	X	X	0	BST-001						
		3	0	X	0	BST-001						
		4	0	0	X	BST-010						
310	1	0	X	0	BST-001	Knob/Lever Key Illuminated Knob	ASD300-2 ASD3K00-2 ASLD300-2	ASD3100-2 ASD31K00-2 ASLD3100-2	ASD3200-2 ASD32K00-2 ASLD3200-2	ASD3300-2 ASD33K00-2 ASLD3300-2		
	2	0	0	X	BST-010							
	3	0	X	0	BST-001							
	4	0	0	X	BST-010							

- Each operator sub-assembly is available as a "-1" and a "-2" for 3-position selector switches. The internal cam of a "-1" is different from that of a "-2". This results in designated combinations of open and closed contacts in the various operator positions.
- N/D = No circuit number designation required in assembled part number.
- X = On (closed contacts) 0 = Off (open contacts). X-X Overlapping contacts remain on (closed) when switch is moved between these two positions.

Switches & Pilot Lights

Display Lights

Relays & Sockets

Timers

Terminal Blocks

Circuit Breakers

Contact Arrangement Chart: 3-Position Selector Switches

Style		Mounting Position	Operator Position			Contact Block Part Number	Description	Operator Part Number			
Contact	Circuit Number		L	C	R			Maintained	Spring Return from Right	Spring Return from Left	Two-Way
4NO	N/D	1	X	0	0	BST-010	Knob/Lever Key Illuminated Knob	ASD300-1 ASD3K00-1 ASLD300-1	ASD3100-1 ASD31K00-1 ASLD3100-1	ASD3200-1 ASD32K00-1 ASLD3200-1	ASD3300-1 ASD33K00-1 ASLD3300-1
		2	0	0	X	BST-010					
		3	X	0	0	BST-010					
		4	0	0	X	BST-010					
	305	1	X	0	X	BST-010	Knob/Lever Key Illuminated Knob	ASD300-2 ASD3K00-2 ASLD300-2	ASD3100-2 ASD31K00-2 ASLD3100-2	ASD3200-2 ASD32K00-2 ASLD3200-2	ASD3300-2 ASD33K00-2 ASLD3300-2
		2	0	0	X	BST-010					
		3	X	0	X	BST-010					
		4	0	0	X	BST-010					
4NC	N/D	1	0	X	X	BST-001	Knob/Lever Key Illuminated Knob	ASD300-1 ASD3K00-1 ASLD300-1	ASD3100-1 ASD31K00-1 ASLD3100-1	ASD3200-1 ASD32K00-1 ASLD3200-1	ASD3300-1 ASD33K00-1 ASLD3300-1
		2	X	X	0	BST-001					
		3	0	X	X	BST-001					
		4	X	X	0	BST-001					
	314	1	0	X	0	BST-001	Knob/Lever Key Illuminated Knob	ASD300-2 ASD3K00-2 ASLD300-2	ASD3100-2 ASD31K00-2 ASLD3100-2	ASD3200-2 ASD32K00-2 ASLD3200-2	ASD3300-2 ASD33K00-2 ASLD3300-2
		2	X	X	0	BST-001					
		3	0	X	0	BST-001					
		4	X	X	0	BST-001					

- Each operator sub-assembly is available as a "-1" and a "-2" for 3-position selector switches. The internal cam of a "-1" is different from that of a "-2". This results in designated combinations of open and closed contacts in the various operator positions.
- N/D = No circuit number designation required in assembled part number.
- X = On (closed contacts) 0 = Off (open contacts). X-X Overlapping contacts remain on (closed) when switch is moved between these two positions.

Operator Truth Tables

Use the following tables to build custom selector switches.

2 Position Selector Switches

	Contact	Mounting Position	Operator Position	
			Left	Right
ASD200	BST-010 (NO)	L	0	X
		R	0	X
	BST-001 (NC)	L	X	0
		R	X	0
	BST-010S (NO-EM)	L	0	X-X
		R	0	X-X
	BST-001S (NC-LB)	L	X-X	0
		R	X-X	0

3 Position Selector Switches

	Contact	Mounting Position	Operator Position		
			Left	Center	Right
ASD300-1 ASLD300-1 ASD3K00-1	BST-010 (NO)	L	X	0	0
		R	0	0	X
	BST-001 (NC)	L	0	X-X	X
		R	X-X	X	0
	BST-010S (NO-EM)	L	X-X	0	0
		R	0	0	X
	BST-001S (NC-LB)	L	0	X-X	X
		R	X-X	X	0

3 Position Push/Pull Switches

	Contact	Operator Position		
		Pull	Normal	Push
AYLD22	BST-010 (NO)	0	0	X
	BST-001 (NC)	X	0	0
	BST-010S (NO-EM)	0	X	X
	BST-001S (NC-LB)	X	X	0

	Contact	Mounting Position	Operator Position		
			Left	Center	Right
ASD300-2 ASLD300-2 ASD3K00-2	BST-010 (NO)	L	X	0	X
		R	0	0	X
	BST-001 (NC)	L	0	X	0
		R	X-X	X	0
	BST-010S (NO-EM)	L	X-X	0	X-X
		R	0	0	X
	BST-001S (NC-LB)	L	0	X-X	0
		R	X-X	X	0

Switches & Pilot Lights

Display Lights

Relays & Sockets

Timers

Terminal Blocks

Circuit Breakers

Accessories – TWTD Series

TWTD Series Accessories

Appearance	Description/Usage	Part Number	
Lamp Removal Tool 	Rubber tool used to install or remove LED's and incandescent lamps	OR-55	
Metal Bezel 	Standard octagonal units (chrome-pl.)	OG-81	
	Extended, non-illuminated (chrome-pl.)	OG-82	
	Extended, illuminated (chrome-pl.)	OG-83L	
	Jumbo Mushroom Shallow Shroud	ABN4G	
	Jumbo Mushroom Deep Shroud	ABN4F	
Plastic Bezel 	Black plastic locking ring/bezel	OGP11B	
Boot/Cover 	In place of ⊕, specify <b>Rubber Boot</b> color: <b>B</b> (black), <b>G</b> (green), <b>R</b> (red), <b>Y</b> (yellow)	OC-11 ⊕	
	Used to cover and protect pushbuttons	Flush units (clear plastic -40° to +60°C).	OC-121
	Extended units (clear plastic -40° to +60°C).	OC-122	
Anti-Rotation Ring 	Plastic washer For nameplates or panels that should not be scratched.	OGL-D1T	
	Thrust washer/Anti-rotation ring for use with notched panel cutout.	OGL-D1S	
Mounting Hole Plug 	Plugs used to fill unused 30mm panel cutouts.	Plastic with locking nut attached.	OBP-11
		Metal with locking nut attached	OB-11
		Grey rubber (-5° to +60°C)	OB-13
Terminal Tab Adaptor 	Tab #250 17/64" x 3/64" (6.35mm x 0.8mm): Single tab	TW-FA1	
Full Voltage Adaptor 	Used on all full voltage illuminated units. Two required per unit. (M3.5 screw and saddle)	APD-F	
Lock Out Adaptor 	Used to provide lockout protection for TWTD pushbuttons and knob selectors. ø 1-13/64" (30mm)	OL-KL1	
Replacement Keys 	Pair of keys (#0)	TW-SK	

Switches & Pilot Lights

Display Lights

Relays & Sockets

Timers

Terminal Blocks

Circuit Breakers

Fingersafe Covers for TWTD Series

Appearance	Description	Used with	Part Number
	Fingersafe terminal cover, for full voltage pilot lights, adds 3mm to overall depth	APD199... full voltage pilot lights	APD-PVL
	Fingersafe terminal cover, for contact blocks, adds 3mm to overall depth	Non-Illuminated pushbuttons ABD..., and AOD...	N-VL2
	Fingersafe terminal cover, adds 1.5mm to overall depth	Transformer pilot lights and illuminated units	N-VL3
	Fingersafe terminal cover, adds 4 mm to depth	Full voltage illuminated pushbuttons	N-VL4

Switches & Pilot Lights

Display Lights

Relays & Sockets

Timers

Terminal Blocks

Circuit Breakers

 Dimensions on page 637.

**Nameplates – TWTD Series**

**Faceplates**

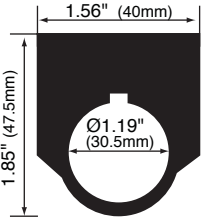
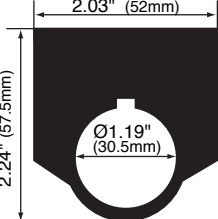
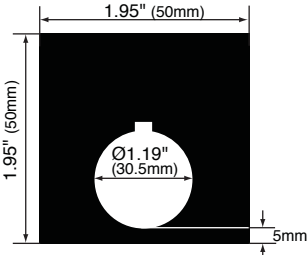
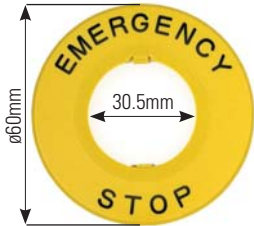
	NALD	NAKD	NAQD	HNAV
<b>Dimensions</b>				
<b>Description</b>	<b>Part Number</b>			
<b>Nameplate (blank)</b>	NALD-B (black) NALD-R (red)	NAKD-B (black) NAKD-R (red)	NAQD-B (black) NAQD-R (red)	HNAV-0
<b>Nameplate (engraved)</b>	NALD-⓪	NAKD-⓪	NAQD-⓪	HNAV-27 "Emergency Stop"

- 1. Nameplates are made of 0.031" aluminum. Lettering is white letters engraved on black background.
- 2. In place of ⓪, insert either the standard legend code from table below or custom engraving delimited by " ".
- 3. HNAV available in yellow only.

**Standard Legend Codes**

Legend	Pushbuttons		Pushbuttons/Selector Switches				Selector Switches		
	Code	Legend	Code	Legend	Code	Legend	Code	Legend	Code
AUTO	101	OPEN	116	AUTO-MAN	201			AUTO-MAN-OFF	301
CLOSE	102	OUT	117	CLOSE-OPEN	202			AUTO-OFF-MAN	302
DOWN	103	RAISE	118	DOWN-UP	203			CLOSE-OFF-OPEN	303
EMERG.STOP*	104	RESET	119	FAST-SLOW	204			DOWN-OFF-SLOW	304
FAST	105	REVERSE	120	FOR-REV	205	REV-FOR	216	FAST-OFF-SLOW	305
FORWARD	106	RUN	121	HAND-AUTO	206	RUN-JOG	217	FOR-OFF-REV	306
HAND	107	SLOW	122	HIGH-LOW	207	RUN-SAFE	218	LEFT-OFF-RIGHT	307
HIGH	108	START	123	JOG-RUN	208	SAFE-RUN	219	LOWER-OFF-RAISE	308
IN	109	STOP*	124	LEFT-RIGHT	209	SLOW-FAST	220	OFF-MAN-AUTO	309
INCH	110	STOP	125	LOWER-RAISE	210	START-STOP	221	OFF-SLOW-FAST	310
JOG	111	TEST	126	MAN-AUTO	211	STOP-START	222	OFF-1-2	311
LOW	112	UP	127	OFF-ON	212	UP-DOWN	223	OPEN-OFF-CLOSE	312
LOWER	113	I (Int'l On)	150	ON-OFF	213			SLOW-OFF-FAST	313
OFF	114	O (Int'l Off)	151	OPEN-CLOSE	214			SUMMER-OFF-WINTER	314
ON	115	EMO	152	RAISE-LOWER	215			UP-OFF-DOWN	315
								1-OFF-2	316
								HAND-OFF-AUTO	317

- 1. \*Available in Red as standard legend code 104 and 124. To order engraved nameplate and codes, add legend code to nameplate part number. Character height based on the number of characters, space and size of nameplate. Standard character size is 3/16".
- 2. Nameplates with standard legends are the same list price as blank nameplates. Special engravings, additional cost.

**To specify engraving instructions, use the Nameplate order form on next page.**

Switches & Pilot Lights

Display Lights

Relays & Sockets

Timers

Terminal Blocks

Circuit Breakers

**Custom engraved Nameplates Order Form — TWTD Series**

Copy this order form and use it to specify Letter Height, Custom Engravings, Location of Engraving on Nameplate, and Quantity Desired. To ensure engraving accuracy, fax it to your IDEC representative. or Distributor.

Your Company Name: \_\_\_\_\_  
 Your Name: \_\_\_\_\_  
 Telephone: \_\_\_\_\_  
 Fax & Email: \_\_\_\_\_

IDEC Rep/Distributor Contact: \_\_\_\_\_  
 PO number (if known): \_\_\_\_\_  
 IDEC Rep/Distributor Phone: \_\_\_\_\_  
 IDEC Rep/Distributor Fax & Email: \_\_\_\_\_

**NALD Nameplate**

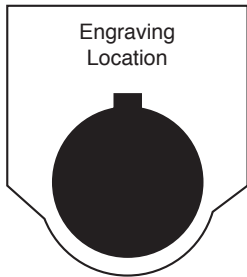

**Step 1.**  
 Choose Letter Size - 7/64" or 1/8".  
 Check the box for the letter size you want. Then write your lettering in box below checkboxes. Note: 1/8" size letters cannot exceed 13 characters.

**Sample Letter Sizes**  
 7/64" Letters: A B C D  
 1/8" Letters: A B C D

**7/64" Letter Size**  11 characters max (for 7/64" size letters)  
**1/8" Letter Size**  9 characters max (for 1/8" size letters)

**Step 2.**  
 Specify Quantity.  
 Enter the number of nameplates desired in the box on the right.

**Qty**

Engraving area with dashed lines and numbers 1-16 below.

**NAKD Nameplate**

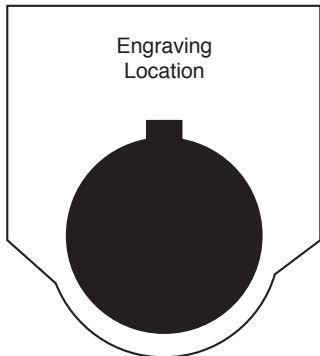

**Step 1.**  
 Choose Letter Size - 7/64" or 1/8".  
 Check the box for the letter size you want. Then write your lettering in box below checkboxes. Note: 1/8" size letters cannot exceed 9 characters.

**Step 2.**  
 Specify Quantity.  
 Enter the number of nameplates desired in the box on the right.

**Qty**

Engraving area with dashed lines and numbers 1-17 below.

**Sample Letter Sizes**  
 1/8" Letters: A B C D

**NAQD Nameplate**

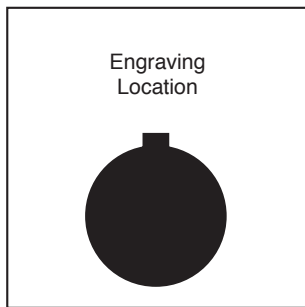

**Step 1.**  
 Choose Letter Size - 7/64" or 1/8".  
 Check the box for the letter size you want. Then write your lettering in box below checkboxes. Note: 1/8" size letters cannot exceed 16 characters.

**7/64" Letter Size**  20 characters max (for 7/64" size letters)  
**1/8" Letter Size**  16 characters max (for 1/8" size letters)

**Step 2.**  
 Specify Quantity.  
 Enter the number of nameplates desired in the box on the right.

**Qty**

Engraving area with dashed lines and numbers 1-20 below.

**Sample Letter Sizes**  
 3/32" Letters: A B C D  
 1/8" Letters: A B C D

Switches & Pilot Lights

Display Lights

Relays & Sockets

Timers

Terminal Blocks

Circuit Breakers



**Switch Engraving Order Form – TWTD Series**

Copy this order form and use it to specify Letter Height, Maximum Number of Lines and Text to be engraved.

To insure engraving accuracy, fax it to your IDEC representative or Distributor.

Your Company: \_\_\_\_\_  
 Name: \_\_\_\_\_  
 Address: \_\_\_\_\_  
 PO: \_\_\_\_\_

Telephone: \_\_\_\_\_  
 Fax: \_\_\_\_\_  
 Email: \_\_\_\_\_  
 Part Number to be Engraved: \_\_\_\_\_

Please check one of the boxes below to indicate your choice of engraving options:



ø29mm, ø40mm Mushroom Head



	# of Lines	Letter Height	Max. Characters Per Line
<input type="checkbox"/>	1	5/32	7
<input type="checkbox"/>		1/8	8
<input type="checkbox"/>	2	5/32	7
<input type="checkbox"/>		1/8	8
<input type="checkbox"/>	3	1/8	8
<input type="checkbox"/>	4	Custom*	

	# of Lines	Letter Height	Max. Characters Per Line
<input type="checkbox"/>	1	3/4	4
<input type="checkbox"/>		5/16	5
<input type="checkbox"/>	2	5/16	5
<input type="checkbox"/>		1/4	6
<input type="checkbox"/>		5/32	8
<input type="checkbox"/>	3	5/32	8
<input type="checkbox"/>		1/8	9
<input type="checkbox"/>	4	1/8	9

	# of Lines	Letter Height	Max. Characters Per Line
<input type="checkbox"/>	<b>Engraving Area 1</b>	5/32	5
<input type="checkbox"/>		1/8	5
<input type="checkbox"/>	<b>Engraving Area 2</b>	5/32	7
<input type="checkbox"/>		1/8	7

\*Engraving is possible, but character size will be smaller than standard sizes.



	# of Lines	Letter Height	Max. Characters Per Line
<input type="checkbox"/>	1	5/32	7
<input type="checkbox"/>		1/8	8
<input type="checkbox"/>	2	5/32	7
<input type="checkbox"/>		1/8	8
<input type="checkbox"/>	3	1/8	8
<input type="checkbox"/>	4	Custom*	

\*Engraving is possible, but character size will be smaller than standard sizes.

Enter text to be engraved:

Line 1: \_\_\_\_\_  
 Line 2: \_\_\_\_\_  
 Line 3: \_\_\_\_\_  
 Line 4: \_\_\_\_\_

**Sample Letter Sizes**

1/8 Letters: **OPEN**  
 5/32 Letters: **OPEN**



All engraving is 5/8mm wide.

For IDEC Internal Use Only:

Work Order #: \_\_\_\_\_

Dimensions

Pushbutton

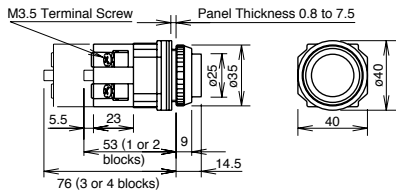

Mushroom Pushbutton w/Full Shroud

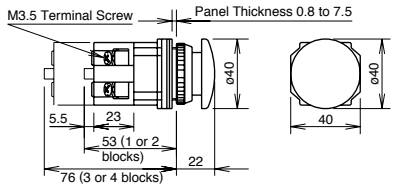

Illuminated Pushbuttons w/AC Adapter w/Transformer

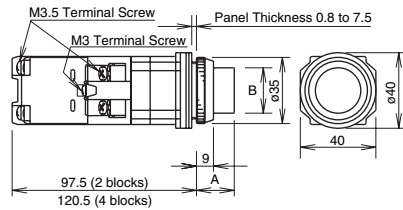

Illuminated Pushbuttons	Dimension A	Dimension B
Flush w/Full Shroud	0.975" (25mm) 0.995" (25.5mm)	ø 0.936" (24mm) ø 0.936" (24mm)
Extended w/Full Shroud	0.741" (19mm) 0.761" (19.5mm)	ø 0.936" (24mm) ø 0.936" (24mm)
ø 1.56" (40mm) Mushroom Pushlock Turn Reset, Push-Pull	*0.975" (25mm) **0.975" (25mm)	ø 1.56" (40mm) ø 1.56" (40mm)

\*Dimension when operator is in reset position.  
\*\*Dimension when operator is in pull position.

Pushbuttons	Dimension A	Dimension B
Flush	0.351" (9mm)	ø 0.975" (25mm)
Extended	0.566" (14.5mm)	ø 0.975" (25mm)
Extended w/Full Shroud	0.663" (17mm)	ø 1.11" (28.5mm)
Mushroom	0.858" (22mm)	ø 1.56" (40mm)
Mushroom w/Full Shroud	0.936" (24mm)	ø 1.87" (48mm)
Jumbo Mushroom	1.13" (29mm)	ø 2.54" (65mm)
Mushroom, Pushlock Turn Reset and Push-Pull ø 1.56" (40mm)	*0.975" (25mm) **0.975" (25mm)	ø 1.56" (40mm) ø 1.56" (40mm)

\*Dimension when operator is in reset position.  
\*\*Dimension when operator is in pull position.

Full Voltage

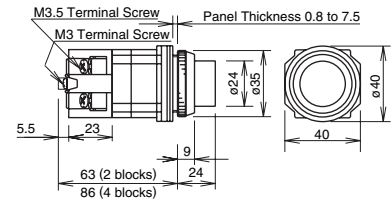

Pilot Lights

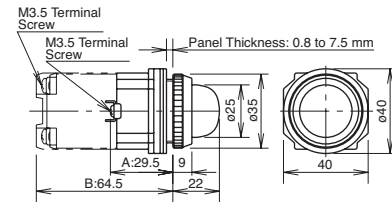

Selector Switches

Knob

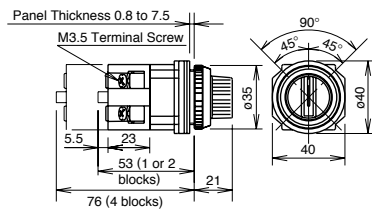

Lever

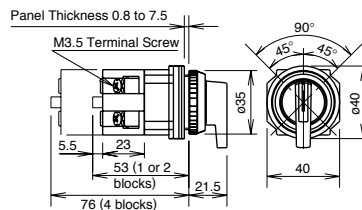

Key

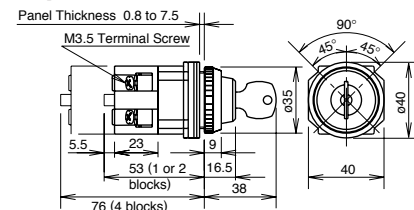

Illuminated Knob

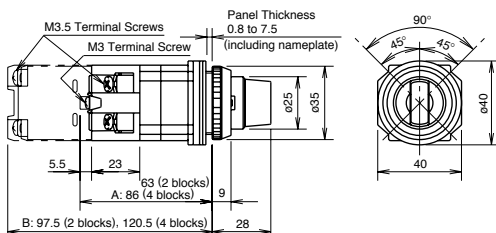

Switches & Pilot Lights

Display Lights

Relays & Sockets

Timers

Terminal Blocks

Circuit Breakers

**Selector Switches Panel Cut-Out**

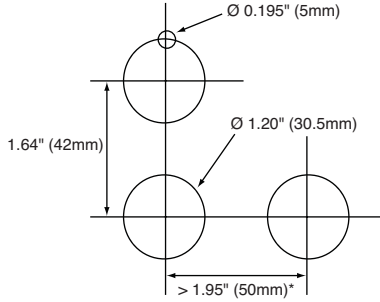

1. \*Jumbo Mushroom < 2.61" (66mm)
2. Minimum mounting centers are applicable to switches with one stack of contact blocks. When mounting two stacks of contact blocks, minimum centers should allow for access to wiring.
3. The ø 0.195" (ø 5mm) recess is necessary when either the nameplate or anti-rotation ring is used.

**Illuminated Selector Switches**

**OL-KL1  
Lock-Out Adaptor**

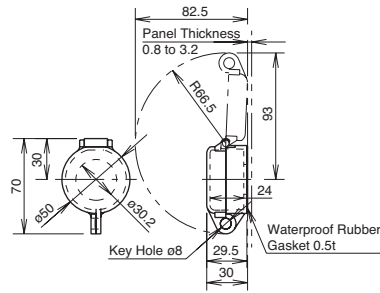

**OC-31  
Pushbutton Clear Boot**

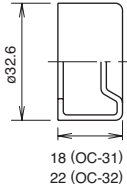

**OGL-31  
Anti-Rotation Ring**

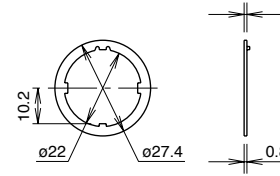

**OB-31  
Mounting Hole Rubber Plug**

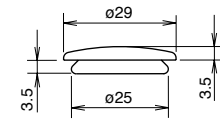

**Finger-Safe Cover**

**N-VL2**

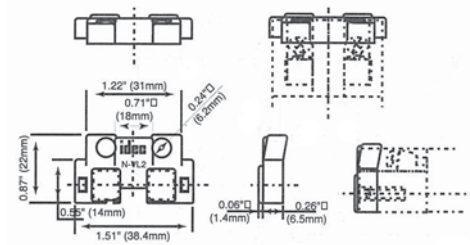

**N-VL3**

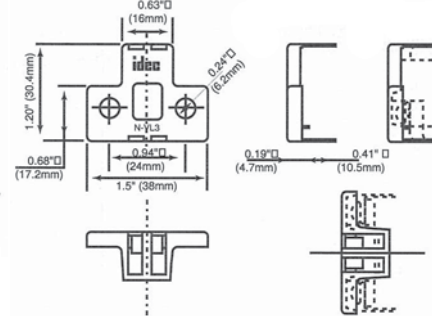

**N-VL4**

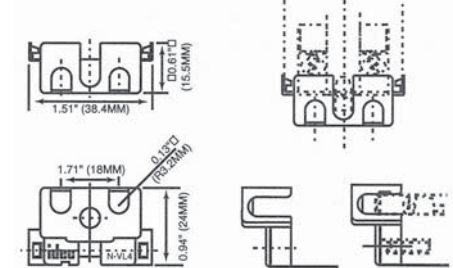

**APD-PVL**

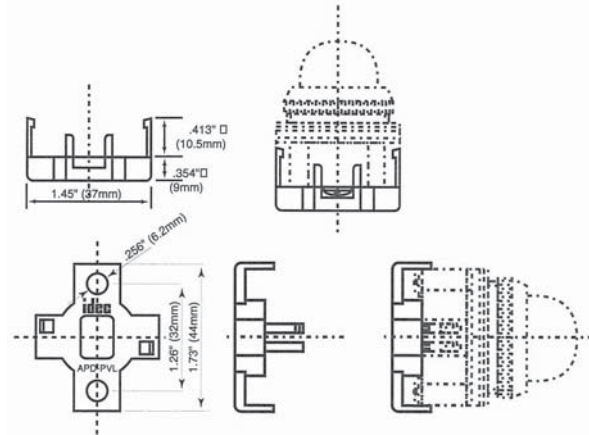

Operating Instructions

Adjustment for Panel Thickness

Each unit is shipped with several waterproof gaskets which are 0.06" (1.5mm) and 0.12" (3mm) thick. Combine the gaskets for a dimension approximately equal to panel thickness and install between the bezel and the body of the unit.

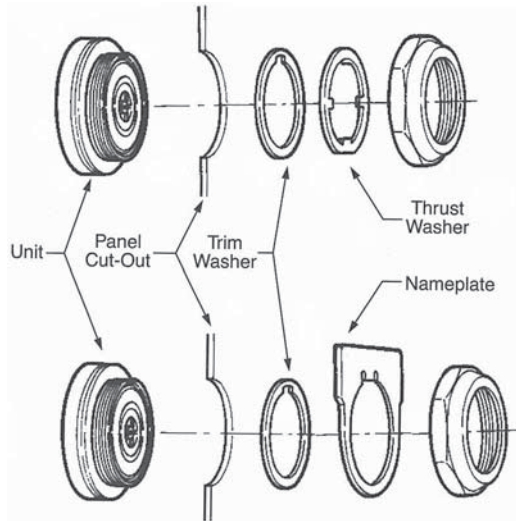

A trim washer must be used with a thrust washer or a nameplate to prevent the control unit from rotating in the mounting hole. When using anti-rotation rings (trim washer with thrust washer or nameplate), install as shown below.

Selector Switches

The operator shaft of each unit has a recess to identify in which direction to install the handle. Align the handle with the recess. Press color insert (TW-HC1) into the Standard Operating Positions.

Standard Operation Positions

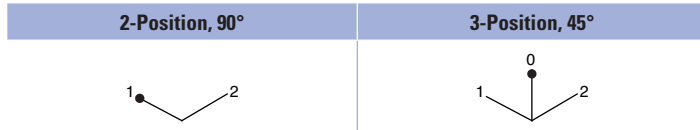

Non-Illuminated 3-Position Operators

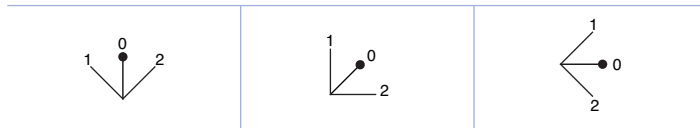

Installation of TWTD Series Units

TWTD Pilot Lights

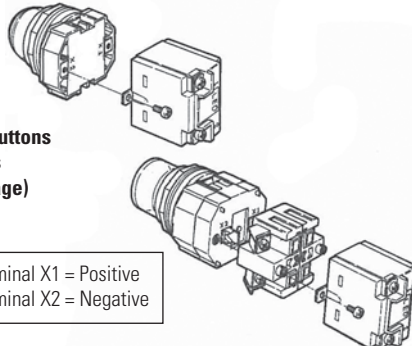

TWTD Illuminated Pushbuttons  
TWTD Selector Switches  
(Transformer or Full Voltage)

Terminal X1 = Positive  
Terminal X2 = Negative

Installation of LED Illuminated Units

Transformer units are recommended for use in areas subjected to inductive noise. When using full voltage types, install a protection diode as shown below. Use diode with AC power supply to protect against reverse polarity. Use with DC power supply to protect against surges and noise.



Make sure that LED illuminated units are installed with correct polarity, as indicated at the terminals.

Application Example For Push-To-Test Pilot Light

A typical application of illuminated pushbuttons is a push-to-test pilot light which can be used to check the lamp/LED circuit.

Transformer/AC-Adapter Circuit

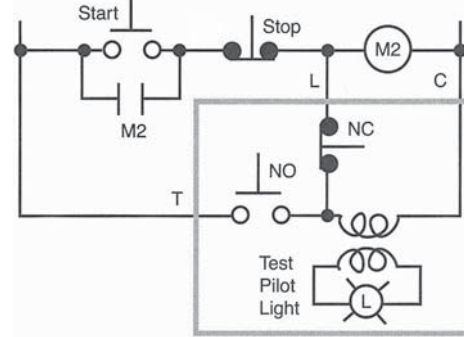

Full Voltage Circuit

