

REV	DATE	DESCRIPTION	APP

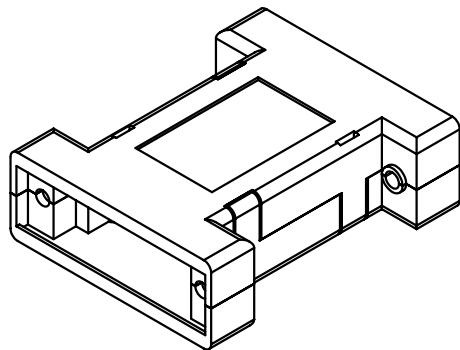
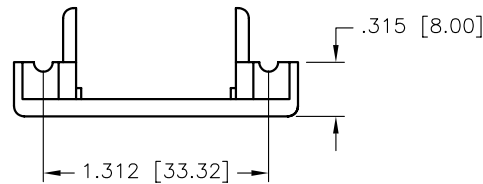
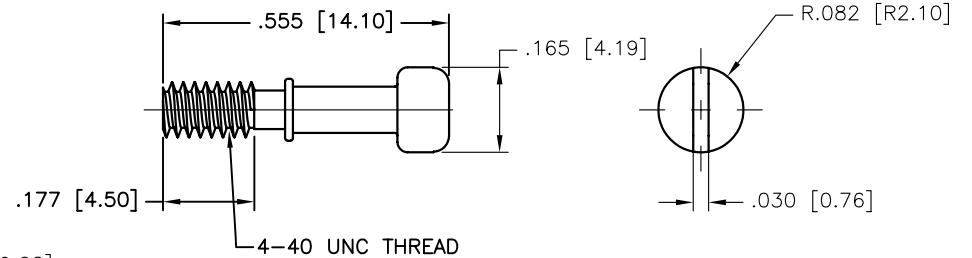
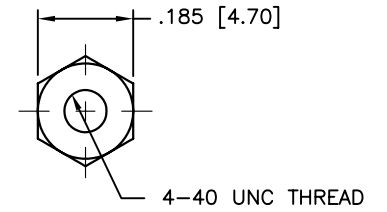
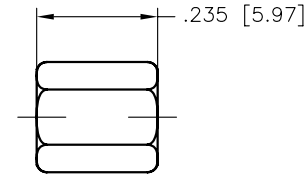
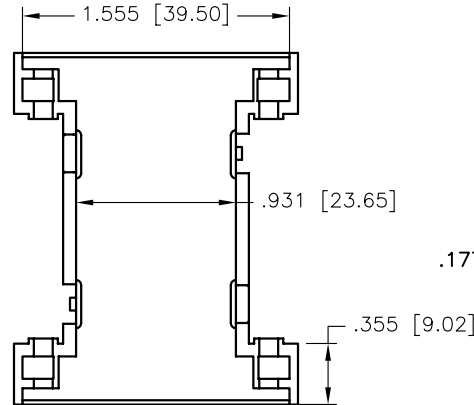
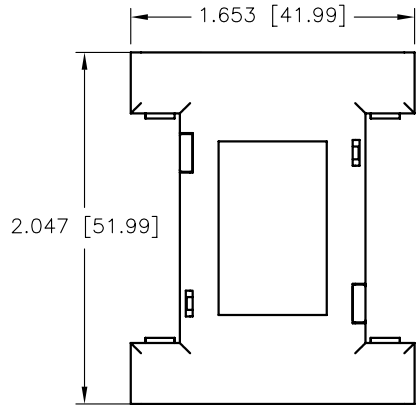
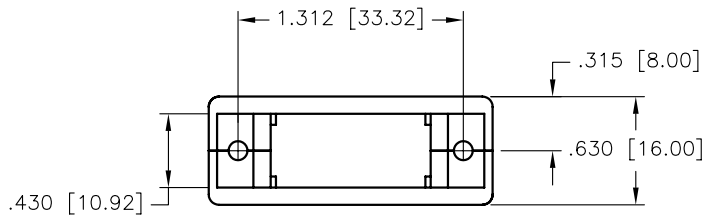

NOTES:

1. MATERIAL: A.B.S. (UL94HB)
2. COLOR: SEE NOTE 5
3. DIMENSIONS: INCHES [MM]
4. KIT INCLUDES:
 - 1 - 2 PC. COVER
 - 4 - #4-40 CAPTIVE SCREW
 - 4 - #4-40 HEX EXTENDER
5. PART NO. 201E15F15F001 - BLACK
PART NO. 201E15F15F003 - GRAY
6. COMPLIANCE NOTE:
PART MUST BE IN COMPLIANCE TO:
DIRECTIVE 2002/95/EC of 27 January 2003 [RoHS]

THIS IS A CONTROLLED DOCUMENT AND IS SUBJECT TO CHANGE. CONTACT NORTHERN TECHNOLOGIES ENGINEERING FOR THE LATEST REVISION.

UNLESS OTHERWISE SPECIFIED	SIGNATURES	DATE	Northern Technologies		
1. ALL DIMENSIONS ARE IN INCHES (MM) 2. DIMENSIONS ARE TYPICAL	DRAWN JSD	03-JAN-06	PART NUMBER 201E15F15F00X DESCRIPTION 15M/F 15M/F GENDER CHANGER COVER [RoHS]		
	CHECKED SCN	03-JAN-06			
	ENG		SHEET 1	CODE 7100_206	DWG NO. 7100-500-206
	ISSUED	03-JAN-06	SCALE N.T.S.		SHEET 1 OF 1

THIS DRAWING IS THE PROPERTY OF NORTHERN TECHNOLOGIES AND SHOULD NOT BE REPRODUCED WITHOUT NORTHERN TECHNOLOGIES WRITTEN PERMISSION.